



Parts For
Studebaker &
Avanti Automobiles
& Studebaker
Trucks



2024 CATALOG

HOURS

Monday - Friday
8:00 a.m. - 5:00 p.m. EST

Phone Hours:

Monday - Friday
8:00 a.m. - 6:00 p.m. EST

CONTACT INFORMATION

111 Aiken St.,
Hope, IN 47246
Phone: (317) 462-3124
FAX: (317) 462-8891
Internet: www.studebaker-intl.com

Fellow Studebaker Drivers

Each new catalog we print contains many new items and this issue is no exception as we continue to identify parts from our vast "New Old Stock" inventory and are actively reproducing new items on a regular basis.

New Avanti Bumpers are now Available!

We try to attend as many swap meets as we can and folks have discovered the convenience and savings on shipping costs when pre-ordering and picking up their parts at said meets.

As most of you know we had to move both our Greenfield, IN and South Bend, IN facilities to Hope, IN and Shelbyville, IN. We invite you to stop in for a visit, just give us a call ahead of time.

Thank you everyone for your continued business.

Jim Lime

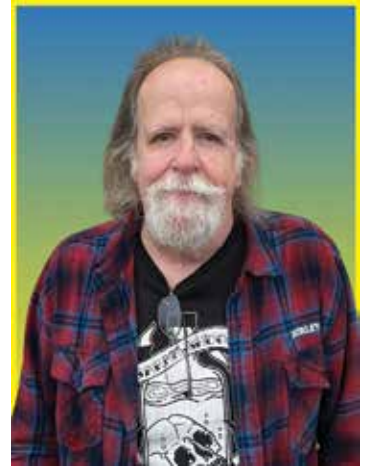

Justin Laird's 1961 Lark Skytop from Napa, California.



Index at a Glance



Alphabetical Index	348-360
Apparel	311-315
Body	85-146
Brakes	246-255
Cooling	181-190
Decals	8-10
Electrical	191-214
Emblems, Script & Ornaments	21-25
Engine	147-170
Fiberglass	289
Fuel	171-180
Floor & Seat Covers	35-37
Gauges, Speedometers, & Instruments	27-28
Glass & Windows	47-56
Glove Boxes	40
Interior	26-46
Introduction	2-7
Manuals	11-17
Mirrors, Rearview	18
Numerical Index	318-347
Order Form	361-362
Pulleys & Belts	57-58
Radio	30-32
Related Items	290-315
Sheet Metal	138-146
Speedometers	27
Steering	257-260
Store Locations	6
Suspension, Steering Drive Line & Differential	261-287
Transmission	215-245
Weatherseals	59-84
Wheel Covers	19-20

Index at a Glance

(317) 462-3124 • FAX (317) 462-8891

Customer Service

If you have questions or just need some clarification concerning what parts to order, please call our customer service department at **(317) 462-3124** and someone will assist you.

You may also place your order using this number. **PLEASE NOTE: WE DON'T DO SERVICE WORK THEREFORE WE ARE NOT ABLE TO ANSWER YOUR MECHANICAL QUESTIONS.**

Telephone Ordering

Our sales personnel process a large volume of telephone orders on a daily basis and we recommend the following procedures to save time for us as well as yourself.

1. Prior to calling, write out a list of the parts you wish to order including the part number and a short description. We recommend using our **ORDER FORM** at the back of this catalog or our online form at http://www.studebaker-intl.com/contact_us.html since the blanks represent the information we'll need to complete your order over the telephone. Part numbers are always preferred for accuracy.

* Please note: Parts ordered by description only are subject to interpretation and may be incorrect. **They are returnable for exchange excluding shipping or return shipping fees.**

**We have found those customers who take the time to make this list before they call require less valuable telephone time and make more accurate purchases.

2. Returning customers please have your customer order number ready. It is printed on the back cover of this catalog on the address label.

New customers will need to provide a credit card number and should have it ready.

3. Call **317-462-3124**

Give the part numbers for the items you wish to purchase and the short description you've prepared ahead of time. You will be asked for your customer number and the method of payment you wish to use to complete the transaction.

4. SHIPPING - Shipping & handling fees are added to all orders as well as state tax for Indiana residents. You may request special handling of your order at this time.

* Refer to the following shipping options to choose your preference.

**No preference: We'll send your purchase based on the most economical basis available upon the time of purchase.

5. Save your list and use it to verify your parts when they arrive against the invoice and contact us if there are discrepancies.

Ordering Suggestions

1. When placing an order or speaking with one of our customer service representatives, please take note of their name. This way if you should need to speak with them again you will know who to ask for.

2. **Pay attention to quantity markers in our Catalog. If an item is listed as a "pr." and you order 2, you will receive 2 pair. If an item is listed as "ea." and you do not specify the quantity you want, you will receive 1 item.

Ordering by Mail

Use the enclosed order form and complete all information including your name and address, customer number, item numbers, and a short description of what you want to order. You may pay by credit card or by check.

Certified checks are not held for clearing, but personal and company checks are held 10 days. All checks must be drawn from a US bank.

**Those sending checks need to add an additional \$10.00 for parts totaling \$100.00 or less, 10% of total on orders of \$100.01 to \$250.00 or 5% of total on orders over \$250.00 to defer some of the shipping charges. This is an estimation of actual shipping cost and discrepancies in fees paid will be returned or charged accordingly. Indiana residents add state sales tax.

*This is for check purchases only. Credit card and telephone orders are charged actual shipping fees when invoiced.

Ordering by Fax

Complete the order form from the back of this catalog or go online to print one from our Website. Please complete the form with all information and **INCLUDE YOUR CREDIT CARD NUMBER, EXPIRATION DATE, AND CVV CODE.**

Be sure you include your address and phone number, as well as, your customer number with the fax. Without this information your order cannot be processed. Fax orders are handled promptly and orders received by noon are typically sent the same day.

Our fax number is
(317) 462-8891

For inquiries, please call our customer service at

**(317) 462-3124 or E-mail
leann@studebaker-intl.com**

Ordering Online

You may now place an order with us via the internet, either by using our online shopping cart or by sending us an e-mail. Our web address is

www.studebaker-intl.com

Our e-mail address for orders and information is

leann@studebaker-intl.com

We'll usually respond by e-mail the next working day.

Ordering from Canada

ONLY CREDIT CARD PAYMENT IS AVAILABLE FOR CANADIAN ORDERS. NO MONEY ORDERS OR CHECKS ACCEPTED.

Follow the same procedures listed before when ordering.

Shipping- All parcels are sent by US mail unless customer requests UPS or DHL.

Ordering from Overseas

ONLY CREDIT CARD PAYMENT IS AVAILABLE FOR OVERSEAS ORDERS. NO MONEY ORDERS OR CHECKS ACCEPTED.

Follow the same procedures listed before when ordering.

Shipping- All parcels are sent by US mail unless customer requests UPS or DHL.

If you have questions or just need some clarification concerning what parts to order, please call our customer service department at (317) 462-3124 and someone will assist you. You may also place your order using this number.

Domestic Shipping and Handling Fees

Shipping & handling fees include charges for shipping, boxes, and packaging as well as any other costs in preparing items for shipment. Smaller items are usually sent priority mail, larger boxes by U.P.S. U.P.S. charges are determined by weight as well as distance. Items requiring separate packages or special handling in preparation for shipment are assessed accordingly. Shipping charges for back ordered items are charged when the item is sent. Some large or heavy items require freight carriers. Our sales personnel can only estimate the cost of shipping an order. We will email your invoice with the exact amount when your order ships.

Third Day Air Service

For U. P. S. deliveries within 3 days you may specify this service. Order by noon Eastern Time on Monday and you will receive it on Thursday. An additional shipping charge applies to U.P.S. Third-Day Air which is based upon the weight of the items shipped.

Second Day Air Service

For faster delivery you may request this service. Delivery is guaranteed by UPS within two working days from the day shipped. This means that you can place an order with us before noon Eastern Time on Monday and have the parts on Wednesday. An additional shipping charge applies to Second Day Air service which is based upon the weight and distance.

NOTE: AEROSOL PAINT CANS CANNOT BE SHIPPED BY AIR.

Next Day Air Service

For next day delivery you may request this service. Delivery is guaranteed by U.P.S. the next working day after being shipped. Saturday delivery is also available for an extra charge. An additional shipping charge applies to Next Day Air service which is based upon the weight of the items shipped.

Exchanges & Refunds

We want to process your exchanges and refunds quickly and efficiently.

***YOU MUST INCLUDE A COPY OF YOUR INVOICE AND A NOTE OF EXPLANATION IN THE SAME BOX WITH THE ITEMS YOU ARE RETURNING. ALL RETURNS NEED TO BE SENT TO OUR HOPE STORE AT 111 AIKEN ST., HOPE, IN 47246. DO NOT SEND RETURNS TO OUR SHELBYVILLE LOCATION.**

*There is a **\$5.00** "Invoice Search" fee (per invoice) for items returned with no invoice. Also, items returned after 30 days from the date of purchase without an invoice are assessed a 20% return fee. Items returned with an invoice within 30 days of purchase are not assessed a return fee.

Please enclose a note of explanation for the return along with the invoice. This note of explanation must be included even if you have previously discussed the problem with a customer service representative. * If you believe an item is defective, please give a detailed explanation of the problem.

DO NOT FAX OR PHONE THIS INFORMATION TO US. IT MUST BE IN THE RETURNED BOX.

State if the item is to be exchanged for another item, a refund is to be issued, or a credit applied to your account.

Carefully repackage the item and return it to us with adequate insurance. Mark the carton "RETURN" near the address label. It is your responsibility to return items safely. Refunds will not be made for articles damaged during return shipment.

Articles may be exchanged or returned for a refund up to 30 days from the date of purchase with no restocking fee. All returned items including packaging must be received by us in the **SAME CONDITION AS WHEN SHIPPED FOR FULL CREDIT. ITEMS RETURNED AFTER 30 DAYS ARE SUBJECT TO A 20% RETURN FEE. SHIPPING CHARGES ARE NOT REFUNDABLE. Absolutely no returns or exchanges after 1 year from the date of purchase.**

NOTE: RETURN SHIPPING CHARGES ARE NONREFUNDABLE FOR ITEMS ORDERED WITHOUT PART NUMBERS.

Back Ordered & No Stock Items

Items marked on your invoice as "Back Ordered" (B/O) are currently not in stock but are expected. These items will automatically be sent to you when available within 30 days of your invoice date. Should they become available after 30 days you will be called to verify that you still wish to order.

Items marked "No Stock" are not currently available and there is no expectation of their availability.

Damaged Articles

All items are insured against damage in shipment. Notify us & we will submit a claim and replace your order. **DO NOT RETURN DAMAGED ITEMS TO US UNLESS YOU ARE INSTRUCTED TO DO SO.**

NOS Parts Disclaimer

Any NOS parts may have surface rust or shelf-wear.

Electrical Parts Returns

Because improper installation can damage electrical parts, some parts are nonreturnable. Please call and check before returning.

Kit Returns

Substitutions or deletions are not allowed for kits. Likewise, if items are returned from kits the special kit price will be changed to the "Total of parts priced separately" amount. In other words, you may actually pay more by returning parts. Please review contents of kits carefully before ordering as you will only receive the special kit price if all kit contents are kept.

Missing Articles

Check contents of box right away to make certain that everything you ordered and paid for (per the invoice) are enclosed. All orders are checked and rechecked prior to shipping. Report any exceptions to us within 10 days of receiving your package by letter or phone **(317) 462-3124.**

It is your responsibility to check your order for shortages within this 10 day period. **NO ADJUSTMENTS WILL BE MADE AFTER 10 DAYS.** Use your customer number and invoice number as a reference.



Oops - I forgot something!

We are always glad to place a second order or even add onto an order for you. But, please understand we don't always have time to locate your prior order and slip the part in to save you from additional shipping charges. No matter how small the added item or items may be, please expect additional shipping charges.

Core Charges

Certain items listed as "exchange" require a refundable core charge in addition to the cost of the part. This core charge is listed on a separate shipping invoice. To receive your refund, please return your old core with **A COPY OF YOUR INVOICE.**

Because of a shortage of cores, some items in the catalog require that the core be sent to us first. No refunds for cores will be issued without a copy of the core invoice within the returned box. Cores received without an invoice will be held for 10 days and then will be considered a gift.

PLEASE DO NOT RETURN CORES TO US AT SWAP MEETS OR CAR SHOWS. *CORES MUST BE RETURNED INTACT. DISASSEMBLED CORES ARE NOT ACCEPTABLE.

Warranty

All new and reproduction parts are guaranteed against defects in workmanship and material for 30 days from the date of purchase. Items not used by the customer or not installed until a later date have no special warranty and are not under warranty past the original 30 days from the date of purchase. Liability of Studebaker International is limited to the replacement of defective parts only and is not liable for any damages to property, loss of time, loss of profits, or any other incidental damages arising from the purchase or use of items purchased. The buyer assumes all risks or losses associated with parts purchased from Studebaker International. Although we make every effort to make the information in this catalog correct, use your Studebaker chassis & body manuals for the exact information and application regarding your vehicle.

Hours

Our Studebaker International Stores are open Monday thru Friday from 8 a.m. To 5 p.m., Eastern Standard Time. Our telephone ordering lines are open Monday through Friday 8 - 6 (EST).

Prices

As collectors and hobbyists, we at Studebaker International are concerned about rising prices and do our best to keep prices as low as possible. Unfortunately, we cannot always avoid increases and therefore cannot be responsible for price changes after this catalog is published. If an ordered item has increased significantly from the listed price we will notify you prior to shipping. If the increase is slight we will go ahead and include it with your order without prior notification.

Discounts

We appreciate customers making large purchases and offer the following special discounts:

Purchase total over	\$750.00	10%
	\$1,500.00	15%

Discount applies to a one time only single purchase and is not cumulative or applicable to future orders. Total is for parts only and does not include core charges, shipping and handling fees or any state tax. Part numbers must be furnished when order is placed and **DISCOUNT DOES NOT APPLY TO ORDERS REQUIRING SPECIAL HANDLING.** Returned parts bringing the total to less than the

required total will void the discount. Discount does not apply to special order items or certain N.O.S. parts. We reserve the right to withdraw this offer at any time.

Drop in and See our Warehouse at 612 Blanchard St., Shelbyville, IN

Studebaker International Restorer Package Discount Terms

This might be the way to go if you are restoring your vehicle and want to take advantage of our volume discounts but would prefer to place smaller orders.

You pay a minimum amount up front of \$3000.00 or more to open your package. You draw from that package by placing ANY SIZE parts or novelty item order you wish and receive a 15% discount {see **discount *exceptions**} on your order. You can also use it on pre-orders for delivery to swap meets that we attend to save on shipping, however you cannot use it to purchase items directly from our booth at a swap meet.

The package stays open until you use up the funds. You can take as long as you need

because it **never expires!** You may add to your package in increments of \$1500.00 or more if you do so before your funds are exhausted. We will supply a statement with your orders showing your available balance.

Restorer Package customers are **required** to provide **part numbers** when ordering, so it is strongly suggested that one of your first purchases might be for body & chassis books if you don't already have them.

Any unused balance is **not refundable** however, you may transfer your balance to another person such as someone purchasing your vehicle.

Returns will be credited back to your Restorer Pkg. account less the 15% discount. Returns received after your package is closed will be refunded in the form of a "store credit" less the 15% discount.

Discount *exceptions: Rare parts, core charges, shipping/handling, shop/service charges, Avanti seat covers, custom sheet metal, certain other custom items, tires, sales tax.

We reserve the right to withdraw or make changes to this offer at any time.

It's just a short drive from our main office in Hope to our warehouse in Shelbyville. Take SR-9 north into Shelbyville. Turn right onto Noble Street. Go through 2 stop signs. Turn right on Bud Street and our warehouse is immediately on the left. **CALL FIRST AS THE HOURS OF THIS WAREHOUSE CAN VARY.**

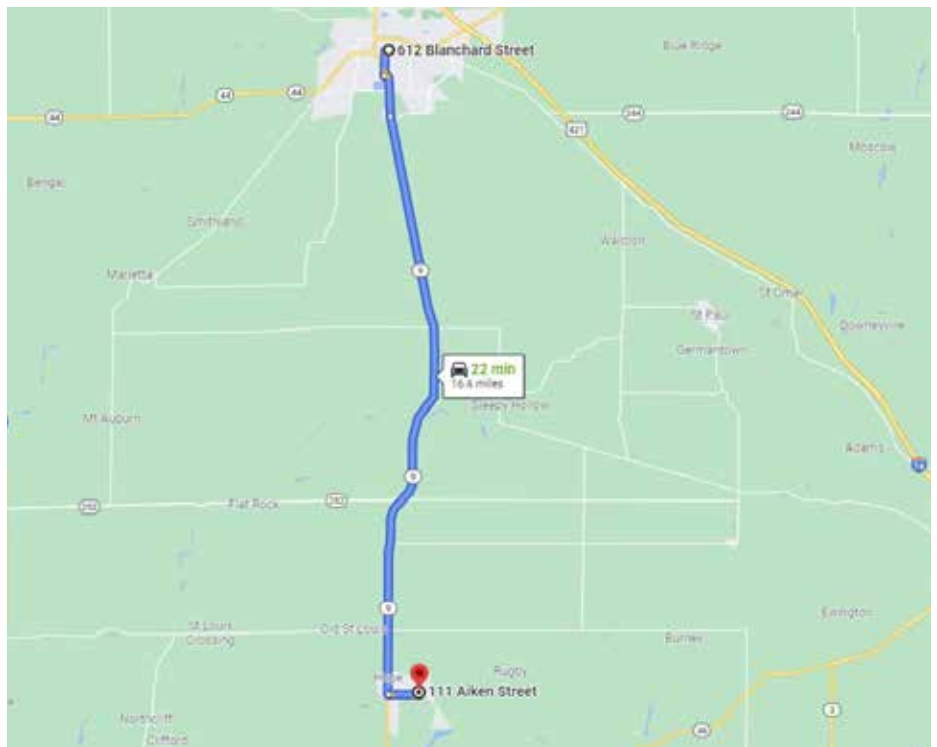

Note: Please do not correspond or mail returns to this address.

Same goes for our Hope Store - We would enjoy seeing you!

Hope, Indiana is Southeast of Indianapolis off of State Road 9, and State Road 252.

If you're traveling from the south on SR-9, turn right onto South St in Hope. Turn left onto Aiken St. Studebaker International is the green roofed building behind the Fire Department. Turn right.

If you're traveling from Indianapolis, take I-65 south to Flatrock exit. Turn left to SR-252. Go 9.5 miles and turn right on SR-9 South. Go 3.9 miles and turn left onto South Street. Go 0.7 miles. Turn left onto Aiken Street. Studebaker International is the green roofed building behind the Fire Department. Turn right.



It is our recommendation that all Studebaker, Avanti & antique car owners be members of a related club.



Studebaker Drivers Club It is our recommendation that all Studebaker owners be members of the Studebaker Drivers Club. This organization publishes a monthly magazine that is loaded with historical information, technical tips, meet locations and reports, and hundreds of classified ads for vehicles, parts and literature. In addition, local chapters exist throughout the U.S. which provide information for obtaining parts and technical information as well as a camaraderie with others sharing a similar interest. Contact: Membership Director S.D.C., Box 1743, Maple Grove, MN 55311-6743 or Call (763) 420-7829

Avanti Owners Association We also advise Avanti owners to join the Avanti Owners Association. The advantages for Avanti owners are the same as those enjoyed by members of the Studebaker Drivers Club - Information, parts, and camaraderie. This organization publishes a quality quarterly magazine that provides Avanti owners with invaluable information. Contact: Membership Director A.O.A.I., Box 1743, Maple Grove, MN 55311-6743 or Call (763) 420-7829

Antique Studebaker Club Owners of Studebakers built through 1946 and M-series trucks are advised to join the Antique Studebakers Club. They publish a magazine six times a year that contains information on the history, maintenance, and restoration of the earlier cars, as well as ads for cars and parts. Contact: Membership Director A.S.C., Box 1743, Maple Grove, MN 55311-6743 or Call (763) 420-7829



SIX CYLINDER ENGINE Valve Cover and Wire Harness Decals



1-061 "Econ-O-Miser". 1946-47 & 1955 6-cylinder trucks **\$5.00 ea.**



1-064 "Super Skybolt Six 230". 1965-66 **\$6.00 ea.**



1-062 "Victory Six". 1955 Wire harness **\$5.00 ea.**



1-063 "Sweepstakes 185". 1956-1958 185 6-cylinder **\$6.00 ea.**



EIGHT CYLINDER ENGINE Valve Cover Decals



1-100 "Pacesetter". 1955 224 V-8 **\$6.00 ea.**



1-103 "Wildcat". 1955 259 V-8 **\$6.00 ea.**



1-081 "Bearcat". 1955 2BBL V-8 162 HP Commander **\$6.00 ea.**



1-082 "Passmaster". 1955 4BBL V-8 185 HP President-Speedster **\$6.00 ea.**



1-083 "Sky Power 352". 1956 Golden Hawk **\$6.00 ea.**



1-084 "Sweepstakes 289". 1956 President & Sky Hawk. 1957-58 President & Golden Hawk **\$6.00 ea.**



1-085 "Sweepstakes 259". 1956 Commander, Power Hawk & 1957-58 Commander & Silver Hawk **\$6.00 ea.**



1-086 "Studebaker Thunderbolt - V8 283". 1965-66 **\$6.00 ea.**



1-087 "Route Star 224" truck **\$8.00 ea.**



NEW -802316 "Work Star 245" truck **\$8.00 ea.**



801655 "Packard Super 289". 1958 Packard & Packard Hawk **\$6.00 ea.**

NOTE: Studebaker Didn't Put Decals On 1959-64 V-8 Valve covers to indicate size, but we have attractive red & blue on chrome decals with either "259" or "289". These are 2½" x 3" and fit in the center of each valve cover. You'll need two!



1-088 "Studebaker 259". Dress up decal. **\$3.50 ea.**

1-089 "Studebaker 289". Dress up decal. All models including Avanti.... **\$3.50 ea.**



OIL FILTER



1-027 1965-66 6-cylinder oil filter decal **\$2.00 ea.**

1-093

A 4-piece Fram filter set. Water decal used on the orange body and black top filter on Studebaker car or truck **\$8.00 set**



1-094 Studebaker oil filter decal. White on clear 3"x2¼". Applied to AC-3300 oil filter. You paint any PB50 filter red, put this decal on it and you'll look factory new..... **\$4.00 ea.**

1-095 "Studebaker Oil Filter" decal. Used on various 1953-66 models with replaceable filter cartridge..... **\$3.00 ea.**



1-096 "Studebaker Full Flow Oil Filter" decal. Use to change PH-11 filter into an original appearing AC-3539 factory oil filter **\$4.00 ea.**

1-097 1957-1962 all models with AC-3300 spin-on oil filter **\$4.00 ea.**



***Note: AC-3539 looks like AC-3311.**



1-104 Sky Power 352. 1956 Golden Hawk oil filter..... **\$6.00 ea.**

VIN TAG DECALS

802312 1953-55 car **\$6.50 ea.**



802313 1956-60 car **\$6.50 ea.**



802314 1963-64 car **\$6.50 ea.**

OIL BREATHER CAP



1-091 STP Oil Breather Cap decal. Blue & white. Takes 2 for V-8, 1 for 6-cylinder. All models, including Avanti **\$2.50 ea.**

GAS

1563218 "Super Premium Gas Only". Red & black decal for 1963-64 Lark, Hawk & Avanti with R-3 or R-4 engines..... **\$3.50 ea.**



GENERATOR TAG

6-001 Red plastic circle. Goes on field terminal nut on generator. **\$5.00 ea.**



AVANTI

3-007 "Use Premium Gas Only". Red & black decal for Avanti gas caps. Also used on 1963-64 Lark & Hawk with R-1 or R-2 engines **\$2.00 ea.**

6-009 Prestolite regulator decal. Use on replacement regulator to give factory original look to 1963-64 Avanti **\$5.00 ea.**



800913 Air cleaner or fan shroud with "Avanti" logo. Standard on later cars and a handsome addition on others **\$6.50 ea.**

AIR CLEANER



3-001 "United Dry Type Air Cleaner". White & black. Water decal. Use on many models with dry type air cleaner, including 1963-64 Avanti.**\$3.00 ea.**

3-002 "United Oil Bath Air Cleaner". Yellow, white & black. Most models with oil bath air cleaner.....**\$3.00 ea.**



3-003 "Fram Carburetor Air Filter". 1953 & 1954 Gold, black & orange. 4"x5 1/4". Used on the long black dry type air cleaners.....**\$10.50 ea.**

3-004 "Wash in gasoline..." decal for wet air cleaner.....**\$2.00 ea.**



3-005 "Studebaker Air Cleaner". Commander. Clear background with white script.....**\$6.00 ea.**

3-006 "Studebaker Air Cleaner". Late 1964-66 6-cylinder. Black and silver.....**\$4.00 ea.**



3-012 1966 Air Cleaner
\$3.50 ea.

3-013 "United Oil Bath Air Cleaner." 1950-52.....**\$6.00 ea.**



3-014 "United Oil Bath Air Cleaner." 1953-55.....**\$6.00 ea.**

802305 Air Cleaner decal for 533023 (1953-54 Commander) air cleaner.....**\$6.00 ea.**



BRAKE

11-001 Brake reservoir warning decal. 1963-64 GT Hawk with disc brake equipped cars. Black letters on red.....**\$2.00 ea.**



11-002 "Equipped with Studebaker Hill Holder," 1"x2" decal calling attention for service ..**\$2.00 ea.**

11-003 Brake reservoir warning decal. Only use DOT 5 silicone brake fluid.



RADIATOR & FAN SHROUD

CAUTION-FAN

5-001 "Caution-Fan". 1959-66 Lark. Orange and black.....**\$3.50 ea.**



5-002 Antifreeze sticker. Blue & yellow pressure sensitive paper.....**\$2.00 ea.**

5-003 Antifreeze tag. 1947-58, early models. Orange.....**\$2.00 ea.**



5-004 Antifreeze tag. 1959-62. Blue & yellow.....**\$2.00 ea.**



5-005 Antifreeze tag. 1963-66, all models including Avanti. Red, white & blue.....**\$2.00 ea.**



5-006 "Notice Permanent Anti-freeze" 1966 models.....**\$1.50 ea.**

AXLE ITEMS

10-001 Twin Traction axle lubricant decal. All models including 1963-64 Avanti. blue on chrome. Used on rear axle plate and sometimes on door post near lube sticker.....**\$3.00 ea.**



10-002 "CAUTION. This vehicle equipped with Twin Traction Differential..." A Studebaker sticker found under hood or on door post for service notice. All models, including Avanti.....**\$2.50 ea.**

TOOL TAG



800360 Original factory metal tool tag. Not a reproduction!.....**\$3.50 ea.**

IGNITION SWITCH

1320422 1957-1958 sedan. Placed above ignition switch.....**\$3.00 ea.**



1320423 Fits over ignition switch. 1957-58 Hawk and all 1957-58 Packard with Twin Traction.....**\$3.00 ea.**

AUTOMATIC TRANSMISSION

"USE AUTOMATIC TRANSMISSION FLUID-TYPE A"

8-001 Type "A" decal. Used on filler tube on automatic drive cars. Also on Superchargers.....**\$2.00 ea.**

TIRE

9-001 Tire warning decal. For inside of glove box. 1963 Super Lark, Super Hawk, Avanti. White with black letters.....**\$3.00 ea.**

9-002 Recommended tire pressure (Cold). Used as a sticker on 1963-64 Sedans and wagons. Orange & black.**\$2.00 ea.**



801117 1987-90 Avanti tire information sticker.....**\$6.00 ea.**

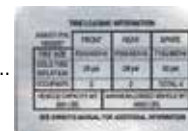

BATTERY ITEM

WARNING CHARGER OR BOOSTER BATTERY TERMINALS MUST BE CONNECTED POSITIVE TO POSITIVE AND NEGATIVE TO NEGATIVE TERMINALS OF CAR BATTERY

6-004 Battery warning. 1963-66 all models, including Avanti. Black & yellow. Goes beside battery, on inner fender.....**\$3.50 ea.**

6-005 Top of battery decal. Same in appearance as what Studebaker used. Make your own factory look by removing all labels and applying this decal! Looks great on black battery case.....**\$3.50 ea.**



6-006 6-V or 12-V "Willard" battery decal. Makes most battery cases look like factory Willard....**\$6.50 ea.**



HEATER



6-002 "The Climatizer".....**\$4.00 ea.**



6-003 "Truck Climatizer..." 3" circle. Goes under hood on heater.....**\$4.50 ea.**

14-003 Heater operation instructions for trucks. Fits on right side of dash on late model trucks. 7E-8E-C.....**\$4.00 ea.**



INTERIOR ITEMS

12-001 Seat belt decals embossed in gold for the buckle. All models, including Avanti.....
\$3.00 ea.



12-002 Fasten seat belt decal, black on embossed chrome. All models, including Avanti.....
\$2.50 ea.

12-003 Door post decal "Studebaker Craftsmen" used on door post of 1963-66 models, including Avanti.....
\$2.50 ea.



12-005 Seat belt decal for original factory 1955-58 seat belts.....
\$3.00 ea.

14-001 Sliding roof caution decal for 1963-66 Wagonaires. Adheres to dash.....
\$2.50 ea.



WINDSHIELD ITEMS



13-001 3" windshield "Quality" decal. 1953-63 car, including Avanti.....
\$5.00 ea.

13-002 "Studebaker Craftsman Built" 3" silver & black decal. 1964-66.....
\$5.00 ea.



13-003 "Another Quality Crafted 1966 Studebaker" Bright blue Studebaker logo with black script.....
\$5.00 ea.

13-004 "S•P Superior Performance Guaranteed". Great for toolboxes, windshields. Used as new car promotion sticker. Vinyl. 5"x5" with 4 1/2" circle.....
\$2.00 ea.



13-005 "Air Conditioned by Studebaker" rear window decal. All models, including 1963-64 Avanti. Silver & black oval.....
\$6.00 ea.



AVANTI MANUFACTURER'S STICKER

801118 Manufacturer's sticker. 1987-90 Avanti.....
\$15.00 ea.



WINDSHIELD WIPER

25-001 American Bosch. 2"x1 1/2". Blue on chrome. Placed on 12-volt wiper motor...
\$4.50 ea.



25-002 American Bosch. Red on chrome. Placed on 6-volt wiper motor.....
\$4.50 ea.



802185 Windshield washer decal for early rectangularly bottle bracket. Pictured above.....
\$3.00 ea.

802186 "Triangular" windshield washer decal. Pictured right.....
\$4.00 ea.

Bottles are not included.

SUPERCHARGER

24-001 "Paxton Supercharger". 1963-64 all models with supercharger, including R-2 Avanti. 4 1/2"x1 1/2". Red, black & chrome.....
\$6.00 ea.



800307 Emblem. 1957-58 Golden Hawk. Fits on top of McCulloch supercharger.....
\$19.00 ea.

801652 Emblem. 1957 packard & 1958 Packard Hawk. Fits on top of McCulloch supercharger.....
\$19.00 ea.



MAINTENANCE STICKERS

A. 801968 "Lubrisurance by Studebaker" maintenance stickers.....
\$3.00/set of 4

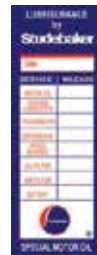

B. 802235 "Lubrisurance by Studebaker" maintenance stickers.....
\$3.00/set of 4

C. 802236 Avanti "Customer Service" maintenance stickers.....
\$3.00/set of 4

GENERAL PURPOSE

19-002 "S•P" decal. 4"x6 7/8". White rectangle with blue script.....
\$2.00 ea.



"Studebaker" decals. All models including 1963-64 Avanti. Blue letters on clear background.

19-012 7" length.....
\$1.00 ea.
19-012C 8" length. Adhesive on positive side for placement inside windows.....
\$2.00 ea.
19-017 3" length.....
75¢ ea.



19-019 "Studebaker" decal. Blue letters on white vinyl. 11" long.....
\$1.50 ea.

19-020 "S" decal. 8 1/2".....
\$4.50 ea.
801777 "S" decal. 3".....
\$3.50 ea.

19-021 "Authorized Studebaker Service". 1 1/2" diameter.....
\$6.50 ea.



801778 "Authorized Studebaker Service" decal. 3" diameter.....
\$3.50 ea.

801779 Red ball logo decal. Red & white. 3" diameter.....
\$3.50 ea.

802396 Red ball decal with reversed adhesive. Adheres to inside of window. 3".....
\$3.00 ea.

LARGER SIZE 19-022 8 1/2" diameter.....
\$4.50 ea.

801780 Studebaker wheel decal. Red, white, blue & black. 3" diameter.....
\$3.50 ea.



801781 "Avanti" decal. Red, White & blue. 3" diameter.....
\$3.50 ea.

801782 "Studebaker Trucks". Red & white. 3" diameter.....
\$3.50 ea.



801783 "Studebaker Racing". Red, white & black. 3" square.....
\$3.50 ea.

802513 1949-64 set of White tailgate letters for trucks.....
\$44.95 set

802304 Studebaker Packard Service Decal, 3" diameter.....
\$3.50 ea.



802306 Studebaker 100% American, 3" diameter.....
\$3.50 ea.



These manuals are reprints from original Studebaker publications and contain much useful information for the restoration and maintenance of your Studebaker. SHOP MANUALS are how-to fix-it books. They contain pictures, diagrams and text on the removal and replacement of most parts of the car. This includes the engine and its component parts, the brake system, front and rear suspension, steering, cooling system, fuel system, transmission, electrical system, and rear differential. Also included is a section on body parts. Besides removal and replacement of body parts, adjustment and alignment of these parts is also covered.

- Model identification information
- Wiring diagrams
- Lubrication charts and information

Most shop manuals also contain:

- Trouble shooting guide
- Tune-up information
- Torque specifications
- Detailed mechanical specifications



801280 1918-24 car, Big & Special Six EG-EH-EL.
400 pages
\$55.00 ea.



801281 1920-24 car.
360 pages
\$35.00 ea.



801249 1935 car.
144 pages
\$22.50 ea.



801250 1936 car.
130 pages
\$22.50 ea.



801251 1937 car.
125 pages
\$22.50 ea.

801252 1938 car.
120 pages
\$22.50 ea.



800413 1939-40 Commander & President.
220 pages
\$25.00 ea.

800414 1939-40 Champion.
176 pages
\$22.50 ea.

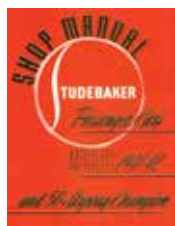

800415 1941-46 car.
260 pages
\$30.00 ea.



800416 1941-48 M-series truck.
135 pages
\$22.50 ea.



800417 1947-49 car.
246 pages
\$30.00 ea.



800935 Repair manual. 1950-55 Detroit gear automatic transmission
\$20.00 ea.



800420 1951-52 car. 286 pages
\$30.00 ea.



800421 1953-54 car.
374 pages
\$35.00 ea.



801705 1954 3R & 1955 E-series truck.
450 pages
\$40.00 ea.



800422 1955 car.
492 pages
\$40.00 ea.



800423 1956-57 car.
680 pages
\$45.00 ea.



800425 1956-64 truck, 1,050 pages
\$55.00 ea.



800424 1958 car, supplement to 1956-57.
120 pages
\$20.00 ea.



800426 1959-64 car, 1,100 pages
\$84.00 ea.



Original manual not reprinted.
802066 8E5-FC Zip Van
\$35.00 ea.



800245 1963-64 Avanti,
400 pages
\$48.00 ea.

Original manual not reprinted.



802073 1965 shop manual. 185 pages. Supplement to 1959-64
\$20.00 ea.



800427 1965-66 car. Supplement to 1959-64.
234 pages
\$25.00 ea.

REPRINTED CHASSIS PARTS MANUALS

Give exploded views of the various parts of the car with corresponding part numbers. These exploded views show in detail the individual components of most parts on the car. Each component has a identification number. These "part numbers" can then be used when ordering parts. Using part numbers is much more accurate than merely providing a description of needed parts, and cuts down on the possibility of receiving wrong parts. Most chassis manuals also include a section on model identification with beginning serial and engine numbers. Parts of the car included in the chassis manual include the engine, transmission, fuel system, exhaust, cooling system, electrical system, brakes, front and rear suspension, steering, instruments, fenders and sheet metal, frame, and rear differential.

8001253 1928-40 6-cylinder car. 520 pages
\$45.00 ea.



8001282 1929-40 8-cylinder car. 450 pages
\$40.00 ea.

800248 1934-46 car, all 6's & 8's. 680 pages
\$45.00 ea.

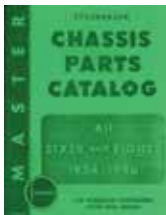

800429 1947-50 car. 310 pages
\$30.00 ea.

800430 1951-54 car, 364 pages
\$40.00 ea.



800431 1955-58 car. 570 pages
\$55.00 ea.

800432 1959-64 car, 650 pages
\$46.00 ea.

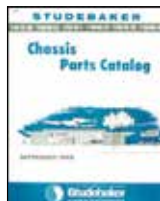

BODY & CHASSIS MANUALS

800439 1941-48 M-series truck, 324 pages
\$35.00 ea.



800438 1965-66 car, 308 pages
\$30.00 ea.



800440 1949-56 truck. 576 pages
\$50.00 ea.

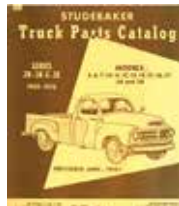

800441 1957-61 truck, 550 pages
\$45.00 ea.



800442 1962-64 truck. 479 pages
\$45.00 ea.

802067 8E5-FC Zip Van. 250 pages. Original manual not reprinted
\$25.00 ea.



800244 Avanti. 1963-64
\$45.00 ea.

802074 1965. 284 pages. Original manual not reprinted
\$15.00 ea.

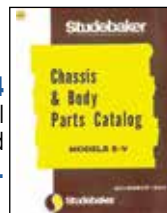

REPRINTED BODY PARTS MANUALS

Give exploded views of many parts of the car not included in the . manual. Part numbers are also listed for each of the component parts. Usually included are sections on accessories & climate controls, body mouldings, instrument panels, interior components, door seals, locks, glass, windshield wipers and structural body parts.

8001283 1928-36 car. 250 pages
\$30.00 ea.



8001284 1929-40, 200 pages
\$45.00 ea.



800433 1936-46 car, all models. 200 pages
\$22.50 ea.

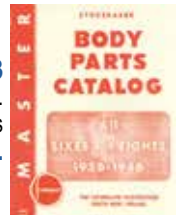

800434 1947-50 car, 180 pages
\$22.50 ea.



800435 1951-52 car, 180 pages
\$22.50 ea.



800436 1953-58 car, 540 pages
\$50.00 ea.

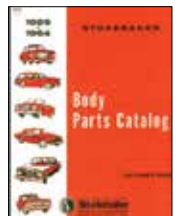

800437 1959-64 car, 341 pages
\$35.00 ea.

SUPPLEMENTS TO THE SHOP MANUALS

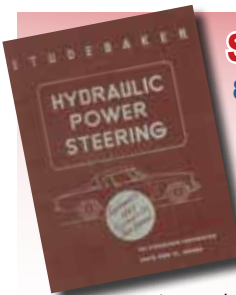

802071 "Hydraulic Power Steering" supplement to the 1953 Studebaker shop manual. When Studebaker introduced their hydraulic power steering in 1953 they created a separate supplement to their shop manual covering repair procedures. This supplement is included in our 800421 1953-54 shop manual. This is an original Studebaker produced supplement and is not a reprint. 24 pages..... **\$15.00 ea.**

802072 1957 Packard Clipper supplement to the 1956 Studebaker shop manual. When the 1957 models were introduced a supplement was printed to cover changes not included in the 1956 shop manual. A separate supplement was made for Studebaker and for Packard models. These supplements are included in our 8000423 1956-57 shop manual. This is an original Studebaker-Packard produced supplement and is not a reprint. 46 pages..... **\$15.00 ea.**

802085 When the 1954 models were introduced Studebaker published this 24-page supplement to their 1953 model shop manual covering specific differences in their 1954 model cars. Reprints of this supplement are included in 800421 1953-54 shop manual. Just as it came from Studebaker, this is an original manual and is not a reprint..... **\$15.00 ea.**

REPRINTED OWNER'S MANUALS

Came in the glove box when the car was new and were intended to acquaint the owner with the new Studebaker. Included are starting instructions, location of instruments and controls, engine break-in procedures, lubrication and service procedures as well as lubrication charts. A listing of specifications is also included. All manuals listed are reprinted unless otherwise stated.

Reprints are copied from originals and are of excellent quality.

802497

1935 President.

\$35.00 ea.



801391

1941 President

\$30.00 ea.



800443

2-R series truck.

\$30.00 ea.



800448 1950 Champion

\$30.00 ea.

801393 1950 Commander

\$30.00 ea.

802177 1950 Land Cruiser

\$30.00 ea.

802075

1951 Champion.

Reprinted

\$30.00 ea.

802076

1951 Commander

\$30.00 ea.

802178

1951 Land Cruiser

\$30.00 ea.



802077 1952 Champion

\$30.00 ea.

802078 1952 Commander

\$30.00 ea.

802184 1952 Land Cruiser

\$30.00 ea.

802179

1953 Champion

\$30.00 ea.

802180

1953 Commander

\$30.00 ea.

802181

1953 Land Cruiser

\$30.00 ea.



800449 1954 Commander

\$30.00 ea.

800450 1954 Land Cruiser

\$30.00 ea.

802183 1954 Champion

\$30.00 ea.

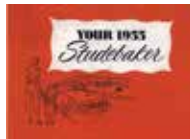

801699

1955 Champion,

Commander & President

\$30.00 ea.

801700 1956

Champion,

Commander,

President & all

Hawks

\$30.00 ea.



802237

1957 Packard

\$30.00 ea.



800547

1957 Studebaker.

Includes Hawk

\$30.00 ea.

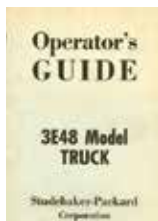

801392 1957-58 3E 48

truck. Originally printed by

Studebaker & new

\$20.00 ea.

800548

1958 Studebaker.

Includes Hawk

\$30.00 ea.



800451

1958 Packard

\$30.00 ea.

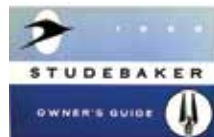

800452

1959 Lark & Hawk

\$30.00 ea.



800453 1960 Lark &

Hawk. Originally printed by

Studebaker & is new

\$30.00 ea.

800454 1961 Lark

& Hawk. Originally

printed by Studebaker

& is new

\$30.00 ea.



800447

1961 6E series truck.

Originally printed by

Studebaker & new

\$30.00 ea.



800455 1962 Lark.

Originally printed by

Studebaker & is new

\$30.00 ea.

800456

1962 Hawk

\$30.00 ea.



800457 1963 Lark.

Originally printed by

Studebaker & is new

\$30.00 ea.

800458 1963 Hawk.

Originally printed by

Studebaker & is new

\$30.00 ea.



800243

1963 Avanti.

\$30.00 ea.

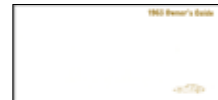

802068 8E5-FC Zip

Van. Originally printed by

Studebaker & is new

\$30.00 ea.



Originally printed by

Studebaker & is new.

800459 1964 Lark.

800460 1964 Hawk

\$30.00 ea.

802218

1964 Avanti.

\$30.00 ea.



800461 1966 sedan.

Originally printed by

Studebaker & new

\$30.00 ea.

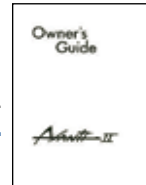

801231

1971-82 Avanti II.

\$20.00 ea.

CLAIMS POLICIES & PROCEDURES MANUAL

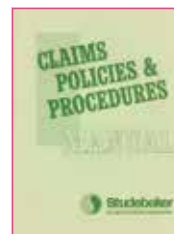

802070 This January

1966 manual clearly states

Studebaker's policies

regarding claims for

damaged shipments and

warranty claims. 30-pages.

Original manual, not

reprinted \$5.00 ea.

1947-49 CHAMPION & COMMANDER



800417 Shop manual.....\$30.00 ea.
 800429 Chassis manual.....\$30.00 ea.
 800434 Body manual.....\$22.50 ea.
 Total of all manuals if purchased separately ..
\$82.50

801181 Special package price.....
\$75.00 set

1949-53 2R TRUCK



800418 Shop manual.....\$30.00 ea.
 800440 Body & chassis manual..\$50.00 ea.
 800443 Owners manual.....\$30.00 ea.

Total of all manuals if purchased separately..
\$110.00

801182 Special package price.....
\$99.00 set

1950 COMMANDER



800419 Shop manual.....\$30.00 ea.
 800429 Chassis manual.....\$30.00 ea.
 800434 Body manual.....\$22.50 ea.
 801393 Owner's manual.....\$30.00 ea.

Total of all manuals if purchased separately..
\$112.50

801184 Special package price.....
\$101.50 set

1950 CHAMPION



800419 Shop manual.....\$30.00 ea.
 800429 Chassis manual.....\$30.00 ea.
 800434 Body manual.....\$22.50 ea.
 800448 Owner's manual.....\$30.00 ea.

Total of all manuals if purchased separately..
\$112.50

801183 Special package price.....
\$101.50 set

1950 LAND CRUISER



800419 Shop manual.....\$30.00 ea.
 800429 Chassis manual.....\$30.00 ea.
 800434 Body manual.....\$22.50 ea.
 802177 Owner's manual.....\$30.00 ea.

Total of all manuals if purchased separately..
\$112.50

802272 Special package price.....
\$101.50 set

1951 CHAMPION



800420 Shop manual.....\$30.00 ea.
 800430 Chassis manual.....\$40.00 ea.
 800435 Body manual.....\$22.50 ea.
 802075 Owner's manual.....\$30.00 ea.

Total of all manuals if purchased separately..
\$122.50

801185 Special package price.....
\$105.75 set

1951 COMMANDER



800420 Shop manual.....\$30.00 ea.
 800430 Chassis manual.....\$40.00 ea.
 800435 Body manual.....\$22.50 ea.
 802076 Owner's manual.....\$30.00 ea.

Total of all manuals if purchased separately..
\$122.50

802079 Special package price.....
\$105.75 set

1952 LAND CRUISER



800420 Shop manual.....\$30.00 ea.
 800430 Chassis manual.....\$40.00 ea.
 800435 Body manual.....\$22.50 ea.
 802184 Owner's manual.....\$30.00 ea.

Total of all manuals if purchased separately ..
\$122.50

802274 Special package price.....\$105.75 set

Manuals make great gifts!

1951 LAND CRUISER



800420 Shop manual.....\$30.00 ea.
 800430 Chassis manual.....\$40.00 ea.
 800435 Body manual.....\$22.50 ea.
 802178 Owner's manual.....\$30.00 ea.

Total of all manuals if purchased separately ..
\$122.50

802273 Special package price.....
\$105.75 set

1952 CHAMPION



800420 Shop manual.....\$30.00 ea.
 800430 Chassis manual.....\$40.00 ea.
 800435 Body manual.....\$22.50 ea.
 802077 Owner's manual.....\$30.00 ea.

Total of all manuals if purchased separately ..
\$122.50

802080 Special package price.....
\$105.75 set

1952 COMMANDER



800420 Shop manual.....\$30.00 ea.
 800430 Chassis manual.....\$40.00 ea.
 800435 Body manual.....\$22.50 ea.
 802078 Owner's manual.....\$30.00 ea.

Total of all manuals if purchased separately ..
\$122.50

802081 Special package price.....
\$105.75 set

1953 CHAMPION



- 800421 Shop manual \$35.00 ea.
- 800430 Chassis manual \$40.00 ea.
- 800436 Body manual \$50.00 ea.
- 802179 Owner's manual \$30.00 ea.

Total of all manuals if purchased separately ..
..... \$155.00

802276 Special package price..... \$126.00 set

1953 COMMANDER



- 800421 Shop manual \$35.00 ea.
- 800430 Chassis manual \$40.00 ea.
- 800436 Body manual \$50.00 ea.
- 802180 Owner's manual \$30.00 ea.

Total of all manuals if purchased separately ..
..... \$155.00

802276 Special package price..... \$126.00 set

1953 LAND CRUISER



- 800421 Shop manual \$35.00 ea.
- 800430 Chassis manual \$40.00 ea.
- 800436 Body manual \$50.00 ea.
- 802181 Owner's manual \$30.00 ea.

Total of all manuals if purchased separately ..
..... \$155.00

802280 Special package price..... \$126.00 set

1954 LAND CRUISER



- 800421 Shop manual \$35.00 ea.
- 800430 Chassis manual \$40.00 ea.
- 800436 Body manual \$50.00 ea.
- 800450 Owner's manual \$30.00 ea.

Total of all manuals if purchased separately
..... \$155.00

802275 Special package price..... \$126.00 set

1954 CHAMPION



- 800421 Shop manual \$35.00 ea.
- 800430 Chassis manual \$40.00 ea.
- 800436 Body manual \$50.00 ea.
- 802183 Owner's manual \$30.00 ea.

Total of all manuals if purchased separately ..
..... \$155.00

802277 Special package price..... \$126.00 set

1954 COMMANDER



- 800421 Shop manual \$35.00 ea.
- 800430 Chassis manual \$40.00 ea.
- 800436 Body manual \$50.00 ea.
- 800449 Owner's manual \$30.00 ea.

Total of all manuals if purchased separately ..
..... \$155.00

802279 Special package price..... \$126.00 set

1955 CHAMPION, COMMANDER, PRESIDENT & SPEEDSTER



- 800422 Shop manual \$40.00 ea.
- 800431 Chassis manual \$55.00 ea.
- 800436 Body manual \$50.00 ea.
- 801699 Owner's manual \$30.00 ea.

Total of all manuals if purchased separately ..
..... \$175.00

801187 Special package price..... \$140.00 set

1956 CHAMPION, COMMANDER, PRESIDENT & HAWK



- 800423 Shop manual \$45.00 ea.
- 800431 Chassis manual \$55.00 ea.
- 800436 Body manual \$50.00 ea.
- 801700 Owner's manual \$30.00 ea.

Total of all manuals if purchased separately ..
..... \$180.00

801188R Special package price..... \$145.00 set

1957 CHAMPION, COMMANDER, PRESIDENT & HAWK



- 800423 Shop manual \$45.00 ea.
- 800431 Chassis manual \$55.00 ea.
- 800436 Body manual \$50.00 ea.
- 800547 Owner's manual \$50.00 ea.

Total of all manuals if purchased separately ..
..... \$200.00

801828R Special package price..... \$145.00 set

1957 PACKARD CLIPPER



- 800423 Shop manual \$45.00 ea.
- 800431 Chassis manual \$55.00 ea.
- 800436 Body manual \$50.00 ea.
- 802237 Owner's manual \$30.00 ea.

Total of all manuals if purchased separately ..
..... \$180.00

802239 Special package price..... \$145.00 set

**Manual Packages
Save Money!**

1958 CHAMPION, COMMANDER, PRESIDENT & HAWK



800423 Shop manual	\$45.00 ea.
800424 Supplement	\$20.00 ea.
800431 Chassis manual	\$55.00 ea.
800436 Body manual	\$50.00 ea.
800548 Owner's manual	\$30.00 ea.

Total of all manuals if purchased separately ..
.....\$200.00

802283 Special package price.....
.....\$162.00 set

1958 PACKARD & PACKARD HAWK



800423 Shop manual	\$45.00 ea.
800424 Supplement	\$20.00 ea.
800431 Chassis manual	\$55.00 ea.
800436 Body manual	\$50.00 ea.
800451 Owner's manual	\$30.00 ea.

Total of all manuals if purchased separately ..
.....\$200.00

802284 Special package price.....
.....\$162.00 set

1959 LARK & HAWK



800426 Shop manual	\$84.00 ea.
800432 Chassis manual	\$46.00 ea.
800437 Body manual	\$35.00 ea.
800452 Owners manual	\$30.00 ea.
800963 Window sticker	\$3.50 ea.

Total of all manuals if purchased separately ..
.....\$198.50

801190 Special package price.....
.....\$179.00 set

1960 LARK & HAWK



800426 Shop manual	\$84.00 ea.
800432 Chassis manual	\$46.00 ea.
800437 Body manual	\$35.00 ea.
800453 Owner's manual	\$30.00 ea.
800964 Window sticker	\$3.50 ea.

Total of all manuals if purchased separately ..
.....\$198.50

801191 Special package price.....
.....\$179.00 set

1961 LARK & HAWK



800426 Shop manual	\$84.00 ea.
800432 Chassis manual	\$46.00 ea.
800437 Body manual	\$35.00 ea.
800454 Owner's manual	\$30.00 ea.
800965 Window sticker	\$3.50 ea.

Total of all manuals if purchased separately ..
.....\$198.50

801192 Special package price.....
.....\$179.00 set

1962 LARK



800426 Shop manual	\$84.00 ea.
800432 Chassis manual	\$46.00 ea.
800437 Body manual	\$35.00 ea.
800455 Owners manual	\$30.00 ea.
800966 Window sticker	\$3.50 ea.

Total of all manuals if purchased separately ..
.....\$198.50

801193 Special package price.....
.....\$179.00 set

1963 AVANTI



800245 Shop manual	\$48.00 ea.
800244 Body & chassis manual	\$45.00 ea.
800243 Owners manual	\$30.00 ea.
800967 Window sticker	\$3.50 ea.

Total of all manuals if purchased separately ..
.....\$126.50

801199 Special package price.....
.....\$113.50 set

1962 HAWK



800426 Shop manual	\$84.00 ea.
800432 Chassis manual	\$46.00 ea.
800437 Body manual	\$35.00 ea.
800460 Owner's manual	\$30.00 ea.
800968 Window sticker	\$3.50 ea.
802044 Accessory manual	\$20.00 ea.

Total of all manuals if purchased separately ..
.....\$220.00

801194 Special package price.....
.....\$179.00 set

1963 LARK



800426 Shop manual	\$84.00 ea.
800432 Chassis manual	\$46.00 ea.
800437 Body manual	\$35.00 ea.
800457 Owners manual	\$30.00 ea.
800967 Window sticker	\$3.50 ea.

Total of all manuals if purchased separately ..
.....\$198.50

801195 Special package price.....
.....\$179.00 set

1963 HAWK

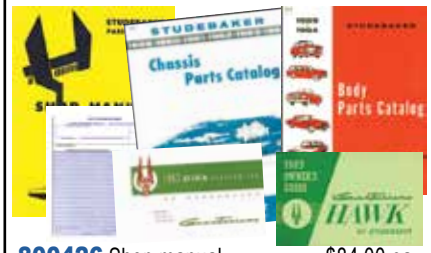

800426 Shop manual	\$84.00 ea.
800432 Chassis manual	\$46.00 ea.
800437 Body manual	\$35.00 ea.
800458 Owners manual	\$30.00 ea.
800967 Window sticker	\$3.50 ea.
802043 Accessory manual	\$20.00 ea.

Total of all manuals if purchased separately ..
.....\$218.50

801196 Special package price.....
.....\$197.00 set

1964 HAWK



- 800426** Shop manual..... \$84.00 ea.
- 800432** Chassis manual..... \$46.00 ea.
- 800437** Body manual..... \$35.00 ea.
- 800460** Owner's manual..... \$30.00 ea.
- 800968** Window sticker..... \$3.50 ea.
- 802044** Accessory manual..... \$20.00 ea.

Total of all manuals if purchased separately ..
..... \$218.50

801198 Special package price.....
..... **\$197.00 set**

1964 AVANTI



- 800245** Shop manual..... \$48.00 ea.
- 800244** Body & chassis manual.. \$45.00 ea.
- 800968** Window sticker..... \$3.50 ea.
- 800247** Accessory manual..... \$12.50 ea.
- 802218** Owner's manual..... \$30.00 ea.

Total of all manuals if purchased separately ..
..... \$139.00

801200 Special package price.....
..... **\$125.00 set**

1964 CHALLENGER, COMMANDER, DAYTONA, & CRUISER



- 800426** Shop manual \$84.00 ea.
- 800432** Chassis manual..... \$46.00 ea.
- 800437** Body manual..... \$35.00 ea.
- 800459** Owners manual..... \$30.00 ea.
- 800968** Window sticker..... \$3.50 ea.

Total of all manuals if purchased separately ..
..... \$198.50

801197 Special package price.....
..... **\$179.00 set**



Homer Freeman's 1962 Lark Daytona from Concord, North Carolina.

REARVIEW MIRRORS

All passenger car mirrors are suitable for both left and right side mounting.

NOTE: Once mounted, mirror adjustment is limited. Studebaker international recommends that mirrors be positioned for best visibility with someone in the driver's seat before you drill the mounting holes.

AC-1400 Reproduction 1947-1952 rearview mirror frequently used on Champion models. Mounting gasket & screws included **\$125.00 ea.**



AC-1400X Right side only. Same as above but with convex glass. Mounting gasket & screws included **\$125.00 ea.**

800771 Additional mounting gasket. Pad to fit between mirror base and body **\$2.00 ea.**

AC-1853 1947-1952 outside rearview mirror. Deluxe style frequently used on Commander & Land Cruiser models **\$105.00 ea.**



AC-1853X Right side only. Same as above but with convex glass. Mounting gasket & screws included... **\$105.00 ea.**

800773 Additional mounting gasket. Pad to fit between mirror base and body **\$2.00 ea.**

1750333 1970-1982 Avanti outside mirror gasket. For inside-adjusting mirror **\$4.50 ea.**

REPLACEMENT CONVEX MIRROR

Have a mirror on the right and want to change it to convex? These will fit reproduction mirrors only. If your mirror is an original Studebaker mirror it will not fit.

801714R Pry out the old glass and glue in (glue not provided) the new. State style of mirror when ordering **\$6.50 ea.**

801714 Same as 801714R but first ship your mirror to us and we'll install the new glass. Return postage extra **\$12.50 ea.**

AC-2340 1953-1955 outside rearview mirror. A handsome addition to your car. Mounting gasket & screws included **\$105.00 ea.**

AC-2340X Right side only. Same as above but with convex glass. Mounting gasket & screws included. **\$105.00 ea.**

800769 Additional mounting gasket. Pad to fit between mirror base and body **\$2.00 ea.**



AC-2728 1953-1958 Super-Vue optional outside mirror. Correct for all sedans and C & K models. Mounting gasket & screws included **\$105.00 ea.**



AC-2728X Right side only. Same as above but with convex glass. Mounting gasket & screws included **\$105.00 ea.**

800772 Additional mounting gasket. Pad to fit between mirror base and body **\$2.00 ea.**

MIRROR INSERT

1546755A Plastic insert only, red background with gold bird. Used with AC-2861X1 mirror **\$45.00 ea.**



1546755B Plastic insert only, black background with gold bird. Used with AC-2861X2 mirror **\$45.00 ea.**

TRUCK MIRRORS

AC-1637 Left. 1949-59 truck. Black painted head, arm and bracket..... **\$99.95 ea.**

AC-1638 Same as AC-1637, but for right side..... **\$99.95 ea.**

801052 Replacement, round painted head, will work on your original left or right arm for AC-1637-8 **\$29.95 ea.**

801853 Left side. 1942-48 M-series truck. Paintable polished aluminum arm with black painted head. Arm is slightly longer than original for better visibility **\$86.00 ea.**

801854 Right side. 1942-48 M-series truck. Paintable polished aluminum arm with black painted head. Arm is slightly longer than original for better visibility. Requires cutting door skin to attach..... **\$86.00 ea.**

AC-2918 Stratoline outside rear view mirror. Available on all 1958-66 model cars. Mounting gasket & screws included..... **\$105.00 ea.**

AC-2935 Replacement mirror only for AC-2918, NOS (will only work for an original mirror), Limited Quantity Available..... **\$45.00 ea.**

AC-2918X Right side only. Same as above but w/ convex glass. Mounting gasket & screws included **\$105.00 ea.**



RIGHT SIDE REARVIEW MIRRORS

Outside rearview mirrors were optional for Studebakers in most states. Right side mirrors were also optional and were rarely ordered as they were small and difficult to see from. When they were installed it was mostly for decorative purposes.

Newer cars use convex glass on the right side mirror to enhance visibility. We now have all of our Studebaker mirrors available with convex glass for the right side. Even though this is not original for the purist, it will provide better visibility and make the right side mirror more functional. All have "Objects in mirror are larger than they appear" written on the surface.

800364 Replacement mirror head. Will work on your original base **\$45.00 ea.**

800364X Right side only. Same as above but with convex glass **\$45.00 ea.**

800770 Additional mounting gasket. Pad to fit between mirror base & body **\$2.00 ea.**

AC-3310 Strato-Vue outside rear view mirror for all Avanti, 1962-66 Lark, or 1962-64 Hawk. Quality reproduction that will complement your car. Mounting gasket & screws included..... **\$120.00 ea.**

AC-3310X Right side only. Same as above but with convex glass Mounting gasket & screws included..... **\$120.00 ea.**

800203 Well nuts and special screws for Avanti.... **\$5.00 pr.**

800768 Additional mounting gasket. Pad to fit between mirror base and body..... **\$2.00 ea.**

AC-3052 Same as AC-3053, but for right side..... **\$135.00 ea.**

AC-3052X Right side only. Same as above but with convex glass..... **\$135.00 ea.**

AC-3053 Left side. 1959-1964 truck. Chrome head and arm with painted mounting bracket..... **\$135.00 ea.**

800365 Replacement rearview mirror. Rectangular chrome head, will work on your original left or right arm. For AC-3052-3 **\$53.00 ea.**

800365X Right side only. Same as above but with convex glass **\$53.00 ea.**

801124 Painted arm & spacer. Right.... **\$62.50 ea.**

801125 Painted arm & spacer. Left..... **\$62.50 ea.**

801126 Chrome arm & spacer. Right... **\$81.50 ea.**

801127 Chrome arm & spacer. Left **\$81.50 ea.**

801128 Painted black bracket. Right **\$32.50 ea.**

801129 Painted black bracket. Left **\$32.50 ea.**

801128B Painted white bracket. Right..... **\$45.28 ea.**

801129B Painted white bracket. Left..... **\$45.28 ea.**



HUBCAPS (NOT FULL WHEEL COVERS)



192688
1938-39 President
\$145.00 ea.



534084 Center cap
for Speedster style wire
hubcaps. Stainless finish
with gold center. 1953-
1956 car all models.
\$80.00 ea.



1558738
1962 car, 1st type.
Chrome "S" on
silver center
\$40.00 ea.



192689
1938-39 Commander &
Coupe Express
\$175.00 ea.

800263 1947-49
Commander &
Land Cruiser. Truck:
1949-59 Beautiful chrome
plated finish
\$145.00 ea



1559379 1963 Lark
Regal, Daytona, Cruiser
\$40.00 ea.



194894 1939-41
Champion. Chrome
finish with red letters.
\$115.00 ea.



1547880
1959 car. Black "S"
on chrome center.
\$40.00 ea.

1560467 1963 car.
F2-Y2-P2. Chrome "S" on
silver center. Silver outer
circle
\$40.00 ea.



197563 1940-1941
Commander
& 1942-1948 M-5
Truck. Chrome with red
letters.
\$99.95 ea.



1549689
1960 car. Black "S"
on chrome center.
Silver outer circle.
\$40.00 ea.



1561288 1964-66
car. Black inner &
outer circles
\$50.00 ea.



527858
Early 1950
Champion. "Studebaker
Champion" white letters
around outer edge.
\$75.00 ea.



1554459
1962 car. Chrome "S"
on red center.
\$40.00 ea.

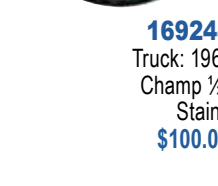

1692449X2
Truck: 1960-64
Champ 1/2 ton.
Stainless.
\$100.00 ea.



1692450X2
1960-64 1/4 ton Champ
truck. Stainless.
\$125.00 ea.

FULL WHEEL COVERS



AC-2118
1950-52
all models
\$100.00 ea.



AC-2799
1956-60
all models
\$125.00 ea.

SPINNER



802508 1953-1964 14" spinner for Halibrand
wheels \$120.00 ea.

802509 1953-1964 15" spinner for Halibrand
wheels \$120.00 ea.

*We have a variety of used wheel covers
and hubcaps that are not listed.*

Call 317-462-3124 to inquire

HUBCAP RETAINING CLIPS

526646 1947-55 car, all models with hubcap requiring clips. Truck: 1941-64, all..... **\$2.95 ea.** 

526646X12 Same as above. Enough for four wheels **\$29.95/set 12**



WHEEL COVER PAINT

801813 Gold paint to restore gold center on AC-2492, AC-2799 & 534084. Looks just like original. 12 oz. aerosol can..... **\$14.65 ea.**

TIRE PRESSURE GAUGE



802252 Red Studebaker script logo on a metallic white tire pressure gauge..... **\$3.95 ea.**

WHEEL WELL MOULDINGS & CLIPS



These mouldings are sold exchange only. Your old repairable mouldings must be received prior to shipment.

801348 1956-64 C & K car. Refinished stainless that looks like new. Comes with new set of clips..... **\$550.00/set 4**

1314792 Right front, only. Includes clips..... **\$150.00 ex.**

1314793 Left front, only. Includes clips..... **\$150.00 ex.**

1314798 Right rear, only. Includes clips..... **\$150.00 ex.**

1314799 Left rear, only. Includes clips..... **\$150.00 ex.**

1337107 Wheel well moulding clip. 1956-64 Hawk. Takes 5 per wheel..... **\$5.95 ea.**

1337107X20 Enough for one car..... **\$119.00/set 20**

VALVE



536701 Tire valve assembly. 1955-1962 Cars and most 1956-1964 1/2 and 3/4 ton trucks having tubeless tires and 3/4" tire rim mounting hole..... **\$10.25 ea.**

CLAMP



661574 1941-1947 M15 & M16 Rear tire rim clamp. For trucks equipped with 20" Dual Daytona Wheels..... **\$10.25 ea.**

HUBCAP & WHEEL COVER RESTORATION KITS



Die cut adhesive backed vinyl shapes to replace original paint.

801716 1937 Dictator & coupe Express. Black "Studebaker" letters for 189718 hubcap..... **\$25.00/set 4**



801717 1951-52 (AC-2118) and 1956-57 crest emblem for full wheel covers..... **\$30.00/set 4**

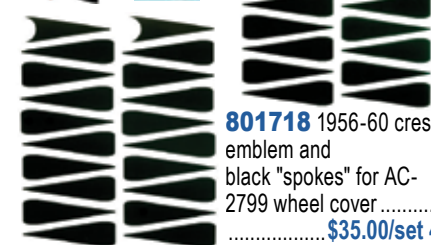

801718 1956-60 crest emblem and black "spokes" for AC-2799 wheel cover..... **\$35.00/set 4**



801719 1961 Lark & 1962-63 Hawk. Center red 'S' and outer black rectangles for AC-3276 wheel cover..... **\$30.00/set 4**

801720 1962 Lark. White "S" and white outer rectangles for AC-3178 wheel cover..... **\$30.00/set 4**

801721 1963-Early Avanti II. Black circle and black outer trim for AC-3332 wheel cover..... **\$25.00/set 4**

PRESIDENT STUDEBAKER

801737 1938 Maroon "Studebaker President"..... **\$25.00 set/ 4**

SPLASH GUARDS & GRAVEL SHIELDS



800110 Dress up your car while protecting its finish from rocks and mud. Suitable for most models front & rear. Black..... **\$18.00 pr.**

AC-1852 1949-64 C-cab front **\$48.50 pr.**

AC-1826 Rear fender gravel shield. Truck: 1949-64 Pickups. Screws included. Fits truck only. Does not fit sedan..... **\$99.00 pr.**

TRUCK SPARE TIRE PARTS

678225 Original Studebaker truck wrench with part number cast. NOS..... **\$35.00 ea.** 

293805 Bolt, Truck spare tire mounting with side mount. N.O.S..... **\$10.25 ea.**

1546533 Lug Wrench. 1958 Car..... **\$40.00 ea.**

G144235 Wing nut, truck spare tire mounting for 293805 bolt. NOS..... **\$3.75 ea.**

CAR SPARE TIRE HOLD DOWN BOLTS

1296X603 Hold down bolt. 1962 - 66 Lark sedan..... **\$9.00 ea.**

1296X614 Hold down bolt. 1956 - 64 Hawk..... **\$9.00 ea.**

1296X622 Hold down bolt. 1959 - 61 Lark sedan & station wagon..... **\$9.00 ea.**

306020 Hold down bolt. 1953-55 C & K-body car..... **\$9.00 ea.**

JACKS AND JACK PARTS

299057 Jack retainer kit. Includes bolt, wing nut, & retainer. 1953-64 C & K includes Hawk & 1953-55 sedan..... **\$19.95 ea.** 

1312816 Spring Jack Hold Down. 1956-61 sedan..... **\$5.50 ea.**

1550471 Jack & 1550472 base. 1960-62 Lark..... **\$125.00 set**

1562344 Jack & 1562345 base. 1963-66 Lark..... **\$125.00 set**

WHEEL PAINT

1962-64 Wheels were all painted off-white. This is an exact match to the original factory color.

800082 White. 12 oz. Aerosol..... **\$14.65 ea.**

800082X1 White, 1 quart can..... **\$56.95 ea.**



SCRIPT



286107W "Studebaker" hood script. 1948-49 Champion and 1947-49 Commander. Chrome **\$35.00 ea.**



286108W "Commander" script. 1947-49 dash. 1950 front fender. Chrome **\$35.00 ea.**



288657-8 "Land Cruiser" script. 1947-50 trunk. 1950 front fender **\$80.00 ea.**



288767W "Champion" script. 1948-49 hood. 1949 dash. 1950 front fenders. Chrome **\$35.00 ea.**



293247WP 1951 "Studebaker" hood name plate, curved **\$110.00 ea.**



293248WP 1951 "Champion" hood name plate, curved **\$110.00 ea.**



293340WP 1951 "Commander" hood name plate, curved **\$110.00 ea.**



296342 "Studebaker" above grille script. 1952. Chrome with white **\$79.95 ea.**

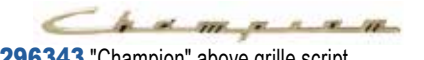

296343 "Champion" above grille script. 1952. Chrome with white **\$40.00 ea.**

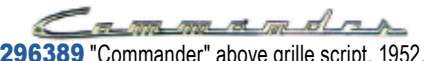

296389 "Commander" above grille script. 1952. Chrome with white **\$40.00 ea.**

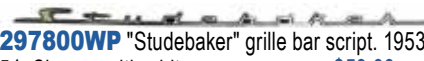

297800WP "Studebaker" grille bar script. 1953-54. Chrome with white **\$50.00 ea.**



298012WP "Land Cruiser" grille bar script. 1953-54. Chrome with white. NOS **\$35.00 ea.**



298675VP "Studebaker" paint line on roof script. 1953-55. Gold w/white **\$65.00 ea.**



299589W "Commander" trunk lid script. 1952-54. Chrome **\$40.00 ea.**



306206WP "Champion" grille bar script. 1953-54. Chrome with white **\$50.00 ea.**



306207WP "Commander" grille bar script. 1953-54. Chrome with white **\$50.00 ea.**



308910W "Commander" rear fender script. 1955. Chrome **\$35.00 ea.**



308911V "President" rear fender script. 1955. Gold **\$40.00 ea.**



652133-4WP Front hood "Studebaker" name plate w/red letters. 1949-53 2-R truck. Can substitute for 653468-9 also **\$195.00 set**



652720 "Studebaker" hood script. 1949-53 2-R truck. Chrome **\$65.00 ea.**

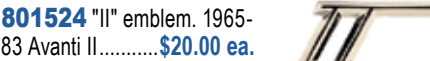

801524 "II" emblem. 1965-83 Avanti II **\$20.00 ea.**



801675V "Speedster" script. 1955 .. **\$50.00 ea.**

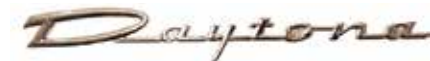

801848V Side moulding "Daytona" script. 1962-63 Lark. Gold **\$35.00 ea.**



1312042V "President" glove box lid script. 1956-57. Gold. NOS **\$25.00 ea.**



1312042W "President" glove box lid script. 1956-57. Chrome. NOS **\$20.00 ea.**



1314300V "Studebaker" script for various applications. 1956-58. Gold **\$45.00 ea.**

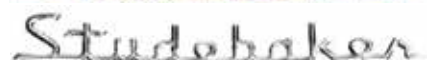

1314300W "Studebaker" script for various applications. 1956-63. Chrome **\$40.00 ea.**



1314761W Trunk lid script. 1956 "Sky" Hawk. Chrome. NOS **\$37.50 ea.**



1314763W Trunk lid script. 1956 "Flight" Hawk. Chrome **\$45.00 ea.**



1314765V Trunk lid script. 1956-58 "Hawk". Gold **\$40.00 ea.**
1314765W Trunk lid & fin script. 1956-61 "Hawk". Chrome **\$35.00 ea.**



1314768W Tailgate script. 1956 "Pinehurst" station wagon. Chrome. NOS **\$47.50 ea.**



1314773V Trunk lid script. 1956-58 "Golden" Hawk. Gold **\$34.95 ea.**
1314773W Trunk lid script. 1956 "Golden" Hawk. Chrome **\$34.95 ea.**



1314774W Trunk lid script. 1956 "Power" Hawk. Chrome. NOS **\$47.50 ea.**



1320940W Trunk lid & fin script. 1957-59 "Silver" Hawk **\$40.00 ea.**



1323071V Rear fender & deck lid script. 1958 "Packard" Hawk. Gold. NOS **\$42.50 ea.**
1323071W 1957-58 "Packard" sedan. Chrome. NOS **\$37.50 ea.**



1332235W Front fenders & rear script. 1959-61 "Lark". Chrome **\$35.00 ea.**

1332236W Front fenders & rear script. 1959-61 Lark "VI". Chrome **\$20.00 ea.**



SCRIPT

VIII **1332237W** Front fenders & rear script. 1959-61 Lark "VIII". Chrome.. **\$25.00 ea.**

CRUISER
1339394W "1961 "Cruiser" emblem. Chrome..... **\$30.00 ea.**

CRUISER
1343244 Front fender script. 1962 "Cruiser". Gold. NOS..... **\$30.00 ea.**
1343244X1 Rear quarter moulding script. 1963 "Cruiser". Gold. NOS..... **\$30.00 ea.**

Gran Turismo
1343546V Door script. 1962-63 "Gran Turismo" Hawk. Gold. Pins slightly larger than original. Requires drilling..... **\$45.00 ea.**

Avanti
1351155V "Avanti" gold script. Nose 1963-89. Back panel 1965-89. The factory may not have made them in gold, but they look good anyway..... **\$45.00 ea.**
1351155W "Avanti" chrome script. Nose 1963-89. Back panel 1965-89..... **\$40.00 ea.**

Wagonaire
1352890V Tailgate script. 1963 "Wagonaire". Gold..... **\$45.00 ea.**
1360492W Script. 1964-66 "Wagonaire". Chrome..... **\$45.00 ea.**

Gran Turismo
1360160W Door script. 1964 "Gran Turismo" Hawk. Chrome. Pins slightly larger than original. Requires drilling..... **\$55.00 ea.**

Challenger
1360488W 1964 "Challenger" script. Chrome..... **\$30.00 ea.**

Commander
1360489W 1964-66 "Commander" script..... **\$35.00 ea.**

Studebaker
1360490W "Studebaker" script. 1964-66 used on all sedan and 1964 Hawk. Chrome..... **\$45.00 ea.**

Daytona
1360493W 1964-66 "Daytona" script. Chrome..... **\$35.00 ea.**

Cruiser
1360494W 1964-66 "Cruiser" script. Chrome..... **\$30.00 ea.**

Hawk
1360495W 1964 "Hawk" deck lid script. Chrome..... **\$30.00 ea.**

TRANSTAR
1654115W "Transtar" truck: 1956-64 C-cab. Chrome..... **\$45.00 ea.**

Deluxe
1654286W "Deluxe" truck, various models. Chrome..... **\$25.00 ea.**

Champ
1655546W Door script. "Champ" truck. Chrome. NOS..... **\$35.00 ea.**

DIESEL
1655898 1962-64 "Diesel" truck fender script..... **\$45.00 ea.**

285927W Diamond ornament. 1947-49 Commander & Land Cruiser. Chrome. Takes 6..... **\$15.00 ea.**

GRILLE, TRUNK, ROOF & DOOR EMBLEMS & ORNAMENTS

286226W "S" emblem 1947-48 Champion & Commander, 1949 Commander. Chrome. 3" height..... **\$45.00 ea.**

289509 Hood medallion for 1950-51 Champion & 1950 Commander & Land Cruiser. Exact reproduction of original..... **\$75.00 ea.**

293987 Hood emblem. 1951 Commander & Land Cruiser. Chrome..... **\$40.00 ea.**

296407W "S" emblem 1952 Hood emblem. Chrome. 3.5" height..... **\$45.00 ea.**

297908 Hood ornament, plastic insert. 1953-55. Excellent quality!..... **\$49.95 ea.**

HOOD ORNAMENTS



290712 Hood ornament, plastic insert. 1950 Champion **\$65.00 ea.**



1323345W Hood ornament. 1957 Scotsman..... **\$25.00 ea.**



1342775 Hood ornament. 1962-63 Lark..... **\$95.00 ea.**

1342775X1 Plastic insert for 1332775 hood ornament. Takes 2..... **\$18.00 ea.**



AC-2344 Hood ornament. 1953. NOS..... **\$195.00 ea.**



1312185 Hood ornament. 1956-61 Hawk, except 58 Packard Hawk. Chrome.. **\$199.50 ea.**

1358580 Hood ornament 1964 Hawk. 1964-66 Larka.. **\$65.00 ea.**



GRILLE, TRUNK, ROOF & DOOR EMBLEMS & ORNAMENTS



297925V "S" trunk emblem. Early 1953 Champion. Gold. 1.25"
.....**\$25.00 ea.**

303587V "S" hood emblem. Early 1953 Champion C & K. Gold. 2.25".....
.....**\$25.00 ea.**

297772V "8" hood emblem. Early 1953 Commander sedan. Gold.
.....**\$25.00 ea.**



298746W Rear fender emblem. 1953-54 Champion. Gold circle with chrome "S".....**\$40.00 ea.**

299175V 1953-54 Commander sedan. 1956 sedan & Hawk. 1957 Commander. Truck: E, 2E, 3E. Gold.....**\$49.95 ea.**

299175W 1953-54 Commander sedan. 1956 sedan & Hawk. 1957 Commander. Truck E, 2E, 3E. Chrome.....
.....**\$39.95 ea.**



308432-3W Right & left, moulding medallions. 1955 V-8 station wagon. Chrome.....**\$160.00 pr.**

522617 Amber jewel plastic insert. 1947-49 Champion fender side emblem & 1947-49 Commander fender top spear.....**\$15.00 ea.**



299444 fender ornament, plastic spear insert. 1953-55**\$25.00 ea.**



303586WP Rear fender "V-8" emblem. 1953-54 Commander ..**\$35.00 ea.**



304823W "V" hood emblem. Late 1953-54 Champion and Commander C & K. Chrome.....**\$65.00 ea.**



304820V "S" hood emblem. 1953-54 sedan.....**\$50.00 ea.**

304825V "S" hood emblem. Late 1953-54 Champion C & K. Gold. 4.5" height.....
.....**\$50.00 ea.**

304830V "S" deck lid emblem. Late 1953-55 & 1962 Lark 6-cylinder. Gold. 3.5" height
.....**\$40.00 ea.**



304827VP "8" hood emblem. Late 1953 and 1954 C & K car. Gold. 4" length.....**\$65.00 ea.**

1343241VP "8" deck lid emblem. 1953-55 & 1962 Lark. Gold. 3" length.....
.....**\$35.00 ea.**



304829W "V" trunk lid emblem. 1953-55. Chrome.....**\$35.00 ea.**

1343240W "V" deck lid emblem. 1962 Lark. Chrome.....**\$35.00 ea.**



522617 Amber jewel plastic insert. 1947-49 Champion fender side emblem & 1947-49 Commander fender top spear.....**\$15.00 ea.**



800035 Front fender retainer ring. 1964 R-series Lark & Hawk.....**\$30.00 ea.**

Note: Because of shrinkage inserts must be filed slightly for proper fit.

1312439W Trunk lid emblem retainer. 1956 Hawk. Chrome.....
.....**\$45.00 ea.**

1312553W Trunk lid emblem retainer. 1956 sedan. Chrome.....
.....**\$45.00 ea.**



1320005P Hood overlay louver. 1957-58 Golden Hawk. Takes 14.....**\$15.00 ea.**



1320010V 1957-58 Golden Hawk hood overlay emblem. Gold...
.....**\$22.50**



1320133WP "V-8" Checkered Flag emblem. 1957 Silver Hawk with 289, 1957 sedan with 289 & 1964 Daytona hardtop.....
.....**\$40.00 ea.**



800585 Plastic crest emblem. Insert only. 1956 & 58 sedan & 1956 Hawk trunk lid, 1957 sedan hood, 1957-58 station wagon tailgate...**\$55.00 ea.**

1314307 Grille emblem for 1956-57 Hawk. Hood emblem for 1956 sedan. Complete with backing & mounting screw.....**\$85.00 ea.**



1320695 Trunk emblem. 1957-58 Hawk. Complete with backing & pins.....**\$85.00 ea.**



1320818W-9W Rear fin louver. 1957-58 Golden Hawk. Only sold in pairs - 1 right & one left. These will also replace louvers on 1957-58 President, 1961 Hawk & 1963 Cruiser..**\$38.00 pr.**



800617W Ten fin louvers. Enough for one car.....**\$190.00/set 10**

We had some complaints on the detail and fit of our gold and chrome Hawk bird emblems. We made new tooling and the emblems are now stamped brass. Just as they were originally! The detail is now identical to the originals and the pin location is an exact match allowing the pins to easily go into the existing holes.

1320941V Bird emblem. 1957-63 Hawk. Gold.....**\$22.00 ea.**

1360162W Bird emblem. 1964 Hawk. Chrome.....**\$22.00 ea.**

1323150 Plastic roof insert. 1957 Packard Clipper. NOS.....**\$21.25 ea.**



1323628W "S" hood emblem. 1957 - 58 Scotsman. Truck: 1959 Scotsman. Chrome. NOS.....**\$25.00 ea.**



1326147 Twin-Traction emblem. Used on various models. Chrome with red "T"s.....**\$27.00 ea.**



GRILLE, TRUNK, ROOF & DOOR EMBLEMS & ORNAMENTS



1326592 Lower right rear moulding. 1958 sedan\$95.00 ea.

1326593 Lower left rear moulding. 1958 sedan\$95.00 ea.

1326721W Chrome nose ring. 1958 Packard Hawk.....\$38.50 ea.

1353370W Trunk emblem retainer ring. 1963 Lark & Hawk & 1964 Hawk\$39.00 ea.



1327014-5W Lower roof Moulding. 1957-58 Golden Hawk. Chrome.

Sold in pairs.....\$85.00 pr.



1327627 Grille emblem. 1958 President. NOS.\$75.00 ea.

1332218W Fin Moulding, right. 1959-61 Hawk.....\$75.00 ea.

1332219W Fin Moulding, left. 1959-61 Hawk.....\$75.00 ea.



1332238 Fin emblem. 1959 Hawk. Chrome with black background\$35.00 ea.

1332243 Grille emblem. 1959 Lark & Hawk. Also 1959 wagon tailgate emblem. Chrome with black background.....\$40.00 ea.

1336389WP Grille emblem. 1960 Lark. Chrome with red background\$40.00 ea.



1338313W Grille emblem. 1961 Lark. Chrome with black background\$40.00 ea.

1337186 Grille emblem. 1960-61 Hawk. Chrome with red background\$40.00 ea.

1337188 Fin emblem. 1960-61 Hawk. Chrome with red background\$35.00 ea.



1343245V Left side, roof emblem. 1962-63 Daytona. Gold\$30.00 ea.



1343246V Right side roof or grille emblem. 1962-63 Daytona. Gold.....\$35.00 ea.

1343245W Left roof emblem. 1964 Challenger. Chrome.....\$25.00 ea.

1343246W Right roof emblem. 1964 Challenger. Chrome\$30.00 ea.

1343548W Trunk emblem retaining ring. 1962 Hawk ...\$35.00 ea.



1343706W Right rear fender Moulding insert. 1962-64 Hawk. Chrome\$55.00 ea.



1343707W Left rear fender Moulding insert. 1962-64 Hawk. Chrome\$55.00 ea.

1350498 Front fender "Supercharged" emblem for 1963 Avanti\$25.00 ea.



1351153W Roof retainer. Chrome piece only. Plastic insert sold separately.....\$35.00 ea.



Note: We weren't satisfied with the quality of this item; so, we purchased new tooling and you'll like the results! The edges are sharp, the retainer securely holds the plastic insert in place and the chrome finish is beautiful!

1351154WP Emblem for rear seat back. 1963-64 Avanti\$45.00 ea.

1351167V Plastic roof insert w/gold "S". Early 1963 Avanti\$39.95 ea.

1351167W Plastic roof insert w/chrome "S". 1963-64 Avanti\$39.95 ea.

1351226W Hood ornament. Chrome. Plastic insert is sold separately.....\$125.00 ea.



801079 Black roof insert. Early Avanti II.....\$25.00 ea.



801080 Black hood insert. Early Avanti II\$30.00 ea.



1358747V Plastic hood insert with gold "S" used before serial #4879\$49.00 ea.

1358747W Plastic hood insert with chrome "S" used after serial #4879\$49.00 ea.

1353371 Plastic deck lid emblem. 1963-64 Hawk. Chrome retainer ring is sold separately.....\$75.00 ea.



1353372 Plastic deck lid emblem. 1963 Lark with 6-cylinder. Chrome retainer ring is sold separately. NOS...\$40.00 ea.



1353373 Plastic deck lid emblem. 1963 Lark V-8. Chrome retainer ring is sold separately...\$75.00 ea.



1353530 Grille emblem. 1963 Hawk. Chrome with red, white & blue inserts. \$45.00 ea.



1353735V Door chevron. 1963 Hawk. Gold w/red, white & blue inserts\$35.00 ea.



1360155W Door chevron. 1964 Hawk. Chrome with red, white & blue inserts. Pin location may not match original. Requires drilling new holes.....\$35.00 ea.



1355042 Grille emblem. 1963 Lark with 6-cylinder. Chrome with white & gold inserts\$45.00 ea.

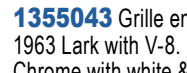

1355043 Grille emblem. 1963 Lark with V-8. Chrome with white & gold inserts\$45.00 ea.



1355438W R-1 fender emblem. 1963 Lark or Hawk\$45.00 ea.



1355439W R-2 fender emblem. 1963 Lark or Hawk.....\$45.00 ea.



1358204WP Fender "8" emblem. 1964-65 Daytona & Cruiser\$40.00 ea.



1358726W Fender "Supercharged" emblem. 1964 Avanti ..\$40.00 ea.





1360150W
Roof side emblem. 1964-66 Commander.....
\$30.00 ea.

1360164
Grille emblem.
1964 Hawk
\$60.00 ea.



1360504
R-1 fender plastic insert for 1964 Lark & Hawk with R-1 Avanti engine.....
\$77.50 ea.



Note: Use with 800035 retainer.

1360505
R-2 Fender plastic insert for 1964 Lark & Hawk with R-2 Avanti engine.....
\$75.00 ea.



Note: Use with 800035 retainer.



1361857WP Interior door panel emblem. 1966 Commander & Wagonaire.....
\$30.00 ea.



1362166WP "194" fender emblem. 1966 Lark.....
\$45.00 ea.

1362167WP "230" fender emblem. 1966 Lar.....
\$45.00 ea.

1362168WP
"283" Fender emblem.....
\$65.00 ea.



1362171X2
1966 Grille emblem.
\$75.00 ea.

1540314 Crest emblem. Radio speaker grille. 1956-57 sedan.....
\$20.00 ea.



NOSE & TRUNK HANDLE LETTERS



801723 "Studebaker" block letters. 1950 Champion & Commander nose & trunk handle. Die cut adhesive backed Studebaker letters replace original paint.....
\$10.00/set 2

REAR SIDE MOULDINGS



1362258 Includes "Cruiser" nameplate. 1966 Cruiser. Right rear side.....
\$75.00 ea.

1362259 Includes "Daytona" nameplate. 1966 Daytona. Right rear side.....
\$75.00 ea.

1362260 Includes "Studebaker" nameplate. 1966 Studebaker. Left rear side.....
\$75.00 ea.

ROOF ORNAMENTS, MOULDINGS & END CAPS

1353080 Right rear roof end cap. 1963-66 station wagon with sliding roof. Chrome.....
\$30.00 ea.



1358562W Right rear roof ornament. 1964 Cruiser. Chrome.....
\$60.00 ea.

1358563W Left rear roof ornament. 1964 Cruiser. Chrome.....
\$60.00 ea.

1361734 Right roof side moulding. 1965-66 Daytona & Cruiser. Chrome.....
\$48.00 ea.

1361735 Left roof side moulding. 1965-66 Daytona & Cruiser. Chrome.....
\$48.00 ea.



Roof end cap. 1965-66 Cruiser & Daytona. Chrome.....
1361736Right
1361737Left

"STUDEBAKER" LETTERS



Trunk: 1957-58 sedan, 1959-61 Hawk, 1964-65 Lark. Hood: 1958 sedan.

1320430X10 Set of 10 letters.....
\$108.00/set

1320430 "S".....
\$12.00 ea.

1320431 "T".....
\$12.00 ea.

1320432 "U".....
\$12.00 ea.

1320433 "D".....
\$12.00 ea.

1320434 "E" (Takes 2).....
\$12.00 ea.

1320435 "B".....
\$12.00 ea.

1320436 "A".....
\$12.00 ea.

1320437 "K".....
\$12.00 ea.

1320438 "R".....
\$12.00 ea.

"LARK" LETTERS

Front fenders 1962-3 Lark.

1343230X8W
Set of 8 letters
enough for 1 car.....
\$70.00/set



1343230W "L".....
\$10.00 ea.

1343231W "A".....
\$10.00 ea.

1343232W "R".....
\$10.00 ea.

1343233W "K".....
\$10.00 ea.

"PACKARD" LETTERS



1958 "Packard" letters for sedan hood & Hawk nose. **NOTE: Letter "P" is not available individually. Only sold in complete set.**

1328060X7 Set of 7 letters.....
\$90.00/set

1328061 "A" (Takes 2).....
\$15.00 ea.

1328062 "C".....
\$15.00 ea.

1328063 "K".....
\$15.00 ea.

1328064 "R".....
\$15.00 ea.

1328065 "D".....
\$15.00 ea.

TRUNK: 1962-63 LARK



1343160X10 Set of 10 letters.....
\$108.00/set

1343160W "S".....
\$12.00 ea.

1343161W "T".....
\$12.00 ea.

1343162W "U".....
\$12.00 ea.

1343163W "D".....
\$12.00 ea.

1343164W "E" (Takes 2).....
\$12.00 ea.

1343165W "B".....
\$12.00 ea.

1343166W "A".....
\$12.00 ea.

1343167W "K".....
\$12.00 ea.

1343168W "R".....
\$12.00 ea.

HOW TO DETERMINE WHAT SEAT BELT LENGTH TO ORDER

- 1) Move the front seat back to its farthest position.
- 2) Have your largest passenger sit in the car.
- 3) Wrap a tape measure around their waist where the seat belt would normally fit them.
- 4) Slip both ends of the tape measure through the rear portion of the seat to the floor of the car.
- 5) Measure the distance around them.
- 6) Order the belt with the length closest to this measurement but still allowing enough room for adjustment.

RECLINING SEAT PARTS

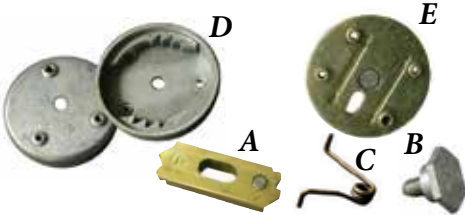

- (A) **1333084** Right gear. 1959-66 Lark & Hawk. Brass..... **\$18.00 ea.**
- (A) **1333085** Left gear. 1959-66 Lark & Hawk. Brass..... **\$18.00 ea.**
- (B) **1333196** Handle screw. 1959-66 Lark & Hawk..... **\$6.50 ea.**
- (C) **1333198** Right handle spring. 1959-66 Lark & Hawk..... **\$4.50 ea.**
- (C) **1333199** Left handle spring. 1959-66 Lark & Hawk..... **\$4.50 ea.**
- (D) **1333980** Right backing plate. 1960-66 Lark & Hawk..... **\$48.50 ea.**
- (D) **1333981** Left backing plate. 1960-66 Lark & Hawk..... **\$48.50 ea.**
- (E) **1333074** Right adjustor plate. 1959 Lark & Hawk..... **\$28.50 ea.**
- (E) **1333075** Left adjustor plate. 1959 Lark & Hawk..... **\$28.50 ea.**
- (E) **1333990** Right adjustor plate. 1960-66 Lark & Hawk..... **\$28.50 ea.**
- (E) **1333991** Left adjustor plate. 1960-66 Lark & Hawk..... **\$28.50 ea.**

SEAT HINGE COVER (METAL)



1333060-1W Beautiful chrome finish that will not only look good but will also not break. 1959-66 Lark & 1959-64 Hawk..... **\$110.00 pr.**

AVANTI HINGE COVER

1347409 Plastic hinge cover for bucket seats. 1963-64 Avanti & Early Avanti II. Available in black, orange, elk, white, and red. Please specify color when ordering..... **\$7.95 ea.**



SEAT HINGE COVER



1959-66 Lark & 1959-64 Hawk. Plastic..... **\$45.00 pr.**
801367..... Black
1340108-9X17..... Tan
1340108-9X23..... Green
1340108-9X24..... Brown

Other colors available - please call.

SEAT BEARING

1355869 Retainer, seat track bearing. 1962-66 Lark and Hawk..... **\$4.50 ea.**

SEAT BACK FRAME

1344053 Seat back frame to bottom bolt, all 1965-1966 models..... **\$5.50 ea.**

SEAT SPRING

298824P Spring, seat pullback. 1953-66 all models..... **\$11.00 ea.**

SEAT ADJUSTER KNOBS



293170X3 Dark gray knob. All 1954-55 car..... **\$18.00 ea.**

1333226X1 Black knob. All 1959-66 car..... **\$15.00 ea.**



1350219 Chrome knob. 1963-early Avanti II.. **\$15.00 ea.**

RECLINER SEAT REPAIR KIT



802318 1959-1966 Car & truck recliner seat repair kit includes left and right side gears and left and right side handle springs..... **\$39.00 ea.**

ARM REST INSERT



1347729 Plate, front armrest insert. 1963 Avanti..... **\$15.00 ea.**



1347780W Armrest insert. 1964 & Early Avanti II. Chrome..... **\$45.00 ea.**



800004 Red-62"	800025 Maroon-62"	800026 Gray-62"	800027 Blue-62"	800028 Green-62"	800029 Tan-62"	800030 Black-62"	801973 Powder Blue-62"	801974 Brown-62"	801975 Off White-62"
\$72.95 each									
800813 Red-72"	800814 Maroon-72"	800815 Gray-72"	800816 Blue-72"	800817 Green-72"	800818 Tan-72"	800819 Black-72"	801976 Powder Blue-72"	801977 Brown-72"	801978 Off White-72"
\$75.95 each									



SEAT BELTS

Original Appearing
 (Listed above) Original appearing seat belts in your choice of colors. Meets current U.S. safety standards. Seat belts come with mounting hardware. All models, car & truck. The total length of belt is approximately 62". Each seat belt will fit one person.

SPECIAL EMBLEM

Seat Belts
 (Listed below) For the older Studebaker's we have a Special Emblem Seat Belt. The total length of each belt is available in 62" or 72". Color choices are same in appearance as above examples. Note: Color is subject to variances due to printing.

801528 Red-62"	801529 Maroon-62"	801530 Gray-62"	801531 Blue-62"	801532 Green-62"	801533 Tan-62"	801534 Black-62"	801979 Powder Blue-62"	801980 Brown-62"	801981 Off White-62"
\$72.95 each									
801535 Red-72"	801536 Maroon-72"	801537 Gray-72"	801538 Blue-72"	801539 Green-72"	801540 Tan-72"	801541 Black-72"	801982 Powder Blue-72"	801983 Brown-72"	801984 Off White-72"
\$75.95 each									



SPEEDOMETER PINION GEAR WITH STANDARD & AUTOMATIC TRANSMISSION

- 513463** 1941-42 Commander & 1941 President w/4.55 rear axle. 20 teeth**\$42.00 ea.**
- 520089** 1947-57 Champion with 4.56 rear axle & 1947-49 Commander with 4.55 rear axle.....**\$26.40 ea.**
- 665106** Truck: 3E to 8E 2, 3, 6, 7 with 4-speed trans. 13 teeth.....**\$42.00 ea.**
- 684115** Truck: 3E to 8E 12 with 5-speed trans. 14 teeth.....**\$34.00 ea.**
- 684116** Truck: 3E to 8E 7,12, 25, 28, 40 with 5-speed trans. 15 teeth.....**\$26.00 ea.**
- 1544759** 1959-66 6-cyl. with 4.56 rear axle 17 teeth.....**\$28.00 ea.**
- 1544760** 1960-66 6-cyl. with 3.31 rear axle. 1960-66 V-8 with 3.07 rear axle. 1963-64 Avanti with auto trans & 3.07 rear axle. 18 teeth**\$28.00 ea.**
- 1544762** 1959 6-cyl. with 3.73 rear axle. 1960-66 6-cyl. with 3.31 rear axle. 1958-66 V-8 w/3.31 rear axle. 1963-64 Avanti w/auto trans & 3.31 rear axle. 20 teeth.....**\$32.00 ea.**
- 1544763** 1959-66 6-cyl. with 4.09 rear axle. 1958-66 V-8 with 3.54 rear axle. 1963-64 Avanti with auto trans & 3.54 rear axle. 21 teeth.....**\$26.00 ea.**
- 1547613** 1959-66 6-cyl. with 4.09 rear axle. 1959-66 V-8 with 3.73 rear axle. 1963-64 Avanti with auto trans & 3.73 rear axle. 22 teeth**\$42.00 ea.**
- 1552104** 1965-66 6-cyl. (standard without o/d) or automatic with 3.73 or 4.09 rear axle.....**\$45.00**
- 1554164** 1963-64 6-cyl. with 4.09 rear axle & auto transmission. 21 teeth.....**\$26.00 ea.**

Note: Have many more please inquire.

SPEEDOMETER PINION GEAR WITH 4-SPEED TRANSMISSION

- 1552964** 1961-62 with 3.07 rear axle. 16 teeth**\$52.00 ea.**
- 1555105** 1961-62 with 3.73 rear axle. 19 teeth.....**\$52.00 ea.**
- 1556038** 1963-64 all models with 4.09 rear axle. 21 teeth.....**\$26.00 ea.**



SPEEDOMETER FACEPLATE



- 800527** 160 mph Speedometer faceplate. 1963-64 Avanti R-2 and early Avanti II. 140 Speedometer can be calibrated for 160 face.**\$29.95 ea.**
- 800529** 140 mph Speedometer face plate. 1963-64 Avanti.....**\$39.95 ea.**

SPEEDOMETERS



- 682133** Trucks 2R type B. Internal.**\$100.00 ea.**

- 1545452** 1956-58 sedan. Internal unit only. Does not include case.....**\$110.00 ea.**



- 1551527** 1961 Lark.**\$125.00 ea.**



- 1554893** 1962 Lark Deluxe.....**\$110.00 ea.**



- 1555529** 1962 Lark Regal**\$115.00 ea.**



- 1558253** 1963-Lark.**\$135.00 ea.**



- 1561125** 1964-66 Lark. 120 mph.**\$135.00 ea.**



- 1561125** 1964-66 Lark. 120 mph. Metric.**\$125.00 ea.**

SPEEDOMETER CABLE CORE



- 519783** 58-15/16". 1947-52 all models w/std. trans. 1953-55 sedan w/ std. trans. 1953-54 Champion C & K with o.d. trans**\$24.00 ea.**
- 526370** 62-15/16". 1950 all models with auto trans., 1950 Champion w/o.d. trans., 1953-55 C & K V-8 with std. & o.d. trans. 1956-57 all models sedan and C & K except 1956 Golden Hawk w/auto trans**\$45.60 ea.**
- 527524** 47-3/4", 1950-52 all models w/auto trans. 1953-55 sedan V-8 w/auto trans.....**\$24.00 ea.**
- 1544772** 1958 all models. 1959-64 Hawk. 1961-64 Lark & Hawk w/4-spd. trans. 1963-64 Avanti w/3-spd., 4-spd., or auto. trans.....**\$35.00 ea.**
- 1544774** 1959-64 Lark without 4-speed. 1965-66 V-8.....**\$24.00 ea.**

SPEEDOMETER CABLES

Complete with housing & core.

- 515566** 1956-57 RHD cars w/overdrive**\$115.00 ea.**
- 519782** 58" long. Fits all 1947-49 car except early 1947 Champion without overdrive. NOS and excellent!**\$75.00 ea.**
- 521778** 1947-49 Champion w/o overdrive. RHD. 82". Also, 1941-48 M-series Truck w/overdrive **\$105.00 ea.**
- 527523** 1950-55 sedan & station wagon w/auto trans.**\$75.00 ea.**
- 530841** 1951-53 Champion and 1951-1952 Commander. RHD w/standard trans. Also, 1953-1954 Commander w/ standard trans. Also, 1953-1954 RHD Sedans & Wagons. Also, 1955 Champion 6-cyl. RHD w/standard trans.**\$115.00 ea.**
- 770093** 1959-64 Lark w/3-spd. std. or auto trans and 1965-66 Lark type (except 194 6-cyl) with standard trans., same as original number 1544770**\$30.00 ea.**
- 676180X3** 70". Truck: 1949-59 5, 6, 10, 11, 15 with 4-speed.....**\$40.00 ea.**
- 677711X2** E Series Truck: 1955-59 2R - 4E 1, 2, 3, 5, 6, 7, 10, 11, 12 with overdrive trans, any 1947-57 car not listed above with the cable length up to 60".....**\$80.00 ea.**
- 677711X3** 70" Truck: 2R - 4E 1, 2, 3, 5, 6, 7, 10, 11, 12 with standard transmission, any 1947-57 car not listed above w/cable length between 60" and 70".....**\$40.00 ea.**
- 1544710** 1959-66 Y-1 body taxi's.....**\$25.00 ea.**
- 1544768** 1958 sedan & Hawk. 1959-64 Hawk with 3-speed std. or auto trans.....**\$75.00 ea.**
- 1553125** 1961-1962 C, K, J, L, & Y bodies w/4-speed.....**\$75.00 ea.**
- 1557262** 1963-64 V8 with 4 speed, except Y1.....**\$75.00 ea.**

We have other Speedometer Cable Cores with or without housings. If you didn't see the one you're looking for please call us at 317-462-3124 to inquire!

TACHOMETER SENDING UNITS

- 800008** Replacement circuitry. 1963-64 Lark & Hawk w/round sending units & 1963-69 Avanti. New board fits inside existing can. Directions included.....**\$145.00 ea.**
 - 800009** Replacement unit for 1962-64 models with rectangular sending units. Complete with wiring & ready to install.**\$135.00 ea.**
- NOTE: All reproduction sending units are pretested prior to shipping. Directions are provided but because incorrect connections will damage unit, no warranty is provided.**





TACHOMETER FACE PLATE

800528 1963-64 Avanti and early Avanti II **\$19.95 ea.**

TACHOMETER HEADS

1694331 Truck: 7E, 35, 45..... **\$135.00 ea.**
1696542 Truck: 8E 15-45 **\$135.00 ea.**



TACHOMETER CABLE

1562571 Tachometer cable. 1964 Lark with round sender..... **\$22.00 ea.**



GAUGE CLUSTERS

Contains gauges for gas & temperature & warning lights for oil & generator in one complete assembly.

1554895 1962 Lark Deluxe **\$115.50 ea.**

1555528 1962 Lark Regal..... **\$115.50 ea.**

OIL GAUGES

522179 1947-49 car, all..... **\$50.00 ea.**
526718 1950 Champion..... **\$75.00 ea.**
526735 1950-52 Commander..... **\$48.00 ea.**
530050 1951-52 Champion..... **\$45.00 ea.**

532596 1953 Champion & Commander. **\$45.00 ea.**



536932 1955 all models except Speedster. **\$45.00 ea.**



676662 Truck: 2R Type A **\$65.00 ea.**

680154 Truck: Late 2R. Type-B **\$55.00 ea.**
683099 Truck: 3R, E-8E **\$82.00 ea.**
1539878 1956-61 Hawk **\$150.00 ea.**
1552829 1961 Lark & 1962 Lark Deluxe..... **\$50.00 ea.**
1557111 1963-72 Avanti **\$175.00 ea.**

1559787 1963 Lark **\$45.00 ea.**



1562589 1962-64 Hawk **\$95.00 ea.**
1562649 1964-66 Lark..... **\$50.00 ea.**
1688365 1959-60 Lark & 1962 Lark Regal. Truck: E-3E 13, 28, 38, 40 & 5E-6E 5-12..... **\$55.00 ea.**
1689500 Truck: Late 3E & All 4E **\$60.00 ea.**

INSTRUMENT CLUSTER



802351 1954, includes speedometer, amp gauge, fuel gauge, oil pressure gauge and temperature gauge..... **\$195.00 ea.**

AMP GAUGES



516710 Late 1942 Champion..... **\$55.00 ea.**
519008 1946 Champion. **\$55.00 ea.**
522178 1947-49 car, all.. **\$78.00 ea.**
526716 1950 Champion..... **No Stock**
526734 1950-52 Commander..... **\$50.00 ea.**
530047 1951-52 Champion..... **\$50.00 ea.**
532591 1953-54 car, all models..... **\$50.00 ea.**
536931 1955 all models except Speedster. **\$50.00 ea.**

676659 Truck: Early 2R. Type-A. Pictured above..... **\$60.00 ea.**
680164 Truck: Late 2R. Type-B..... **\$60.00 ea.**
1539877 1956-61 Hawk..... **\$150.00 ea.**
1557113 1963-72 Avanti **\$175.00 ea.**
1559784 1963 Lark..... **\$40.00 ea.**
1686089 Truck: 5E-8E **\$45.00 ea.**

TEMPERATURE GAUGES

515609 Early 1942 & All 1946 Champion. Includes sending unit. **Substitute with 516712**
516701 Late 1942 Commander & President. Includes sending unit..... **\$110.00 ea.**
516712 Late 1942 Champion. Includes sending unit..... **\$110.00 ea.**



526719 1950 Champion..... **\$75.00 ea.**

526739 1951-52 Commander..... **\$55.00 ea.**
530051 1951-52 Champion..... **\$55.00 ea.**
532597 1953-54 car all models..... **\$55.00 ea.**
536930 1955 all models except Speedster. **\$66.00 ea.**
1539879 1956-61 Hawk..... **\$150.00 ea.**

1541287 1956 sedan..... **\$55.00 ea.**



1545446 1958 sedan..... **\$55.00 ea.**
1548690 1959-60 Lark. Truck: 1960-64 Champ. **\$65.00 ea.**

1552984 1961 & 1962 Lark with white face. **\$55.00 ea.**

1555709 1961 Lark & 1962 with black face..... **\$55.00 ea.**
1562590 1962-64 Hawk..... **\$160.00 ea.**
1689566 Truck: Late 3E-All 4E..... **\$110.00 ea.**
1692901 Truck: 5E-6E C-cab..... **\$110.00 ea.**



1542343 1957 sedan..... **\$55.00 ea.**



GAS GAUGES

196897 1939-40 Champion. **\$90.00 ea.**
515506 Early 1942 Commander & President..... **\$90.00 ea.**
516713 Late 1942 Champion..... **\$80.00 ea.**
519007 1946 Champion..... **\$80.00 ea.**
522177 1947-49 car, all..... **\$80.00 ea.**
526717 1950 Champion. **\$70.00 ea.**
526738 1950-52 Commander..... **\$72.00 ea.**
530048 1951-52 Champion..... **\$65.00 ea.**



536838 1955 Speedster **\$195.00 ea.**

536929 1955 all models except Speedster..... **\$70.00 ea.**

676661 Truck: Early 2R. Type-A..... **\$79.75 ea.**
682136 Truck: Late 2R "Type B" **\$85.00 ea.**
683098 Truck: 3R & E..... **\$70.00 ea.**
1539880 1956-61 Hawk **\$150.00 ea.**

1541286 1956 sedan **\$55.00 ea.**



1542342 1957 sedan **\$55.00 ea.**



1552983 1961 Lark & 1962 with white face..... **\$60.00 ea.**

1555708 1962 Lark with black face. **\$55.00 ea.**
1557110 1963-72 Avanti **\$175.00 ea.**
1686096 C-cab Truck: 2E & 5E - 8E **\$85.00 ea.**

GAUGE RELATED PARTS

1540121 Tachometer bracket. 1956-61 Hawk. Chrome..... **\$30.00 ea.**



1552976 Retainer ring for speedometer & instrument cluster. 1961-66 Lark. Also fits clock 1963-66 Lark **\$35.00 ea.**

1555431 Retainer ring. For speedometer, clock, or tachometer. 1962-64 Hawk. **\$45.00 ea.**



1559983 Tachometer head retaining. 1963-64 Lark. Chrome ... **\$35.00 ea.**

INTERIOR MIRROR BRACKETS & HARDWARE

- G124896** Nut, mirror to ball post. All models.....
..... 15¢ ea.
G161791 Screw, retainer to bracket. All models...
..... 15¢ ea.



1320879 Interior mirror bracket. 1956-60 sedan. Primer.....\$15.50 ea.

1320880

Ball post. All models.
.....\$8.75 ea.



1320881 Ball post retainer. All models.....
.....\$7.50 ea.

1338569P Bracket. 1961-63 Lark. Painted...
.....\$18.50 ea.



1356317P Bracket. 1964-66 Lark. Painted.....
.....\$18.50 ea.

INSIDE REARVIEW MIRRORS

New production interior rearview mirrors. Beautiful chrome finish with smoked gray glass, just as on the originals.



1339259X1 1961-64 Hawk, chrome.....
.....\$71.75 ea.

1339259X2 1961-64 Hawk, painted
.....\$40.00 ea.



801725 Day/Night rearview mirror. 1963-85 Avanti. Fastens to your original mirror stem. Stainless steel..
.....\$94.50 ea.

SUNVISOR RETAINER ROD

802194 1963-85 Avanti. Chrome.....
.....\$7.50 ea.
1334254x220 1962-1963 Champ truck, white.....
.....\$14.95 ea.



SUNVISOR MIRRORS



801789 This is a GM part that will work well on your custom or modified Studebaker. Fits on both right and left visor & is lighted.\$15.00 ea.



1351150 Replacement vanity mirror. 1964-66 Lark, 1963 - 83 Avanti.....
.....\$12.95 ea.

1352683 Replacement vanity mirror. 1963 Lark...
.....\$13.25 ea.

SUNVISORS



Padded style in off-white vinyl or order a headliner and we can match the color. Does not include mounting bracket.

- 652816-7** 1949-59 Truck (stock color is tan).....
.....\$167.00 pr.
1319176-7 1957-59 sedan \$229.95 pr.
1319182-3 1957-61 Hawk..... \$229.95 pr.
1340392-3 1959- early 1962 Lark without retainer rod. \$229.95 pr.
1346528-9 1962-64 Hawk with retainer rod. \$229.95 pr.
1359008-9 Late 1962 - 66 Lark. Includes retainer rod. \$229.95 pr.

AVANTI SUNVISORS

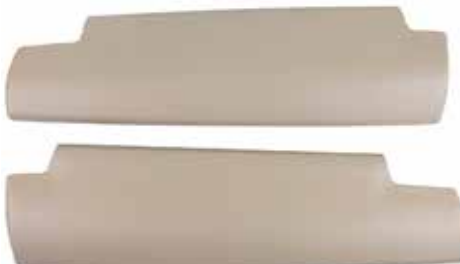

1347700-1 Avanti sunvisors. 1963 to early Avanti II models. Excellent quality! Specify color when ordering.\$185.00 pr.

SUNVISOR CLIP



1344444 Clip. Late 1962-65 car, all models. White. (Pictured).....
.....\$3.50 ea.
1344444X2 Clip. 1966. Chrome.....\$5.00 ea.



1344441 Rod. Late 1962-65 Lark & Hawk. Fits into end of sunvisor. White.....\$4.50 ea.
1344441X3 Rod. 1966. Chrome. Pictured.....
.....\$6.50 ea.

REAR PACKAGE SHELF COVER

Note: State year model & color when ordering. Choose from: red, blue, dark green, off-white, black, gray, brown & tan. We cannot match every factory color but this material is easily paintable. Most rear shelves are available for immediate shipment.

- 800834R** 1947-52 2 & 4-door sedan. Includes Starlight coupe.....\$49.95 ea.
800835R 1953-61 C & K. Includes Hawk.....
.....\$42.95 ea.
800836R 1953-66 2- & 4-door sedan including Lark\$38.95 ea.
800837R 1962-64 Hawk\$38.95 ea.

RETAINER CLIP

1346972 Rear shelf retainer clip, most models. Paint to match. Takes 4.....\$3.50 ea.



AVANTI CONSOLE PARTS



Avanti glove box & center console liner set.

- 801928** 1963 Maroon\$28.50 set
801928B 1963 Black.....\$28.50 set
801929 1964 Black\$28.50 set



1358914 Console blank. 1963-85 Avanti without air conditioning. Chrome plate only. Does not include walnut or aluminum overlay.....
.....\$65.00 ea.



1347584R 1963 Avanti console end cap made of durable fiberglass that appears identical to the original and is very easily installed. Available in most original colors. Please specify color when ordering...
.....\$44.95 ea.



1350216 Center console lid handle, 1963 to early Avanti II.\$28.00 ea.
1350217 Center console lock hole escutcheon, 1963 Avanti.....\$12.00 ea.

STEREO RADIO

Now you can have a modern stereo radio in your 1958-66 Studebaker, 1963 to early Avanti II or Champ Pickup. Our custom-designed stereo radios fit right in the dash opening and use the original factory faceplate and you do not have to cut or modify the dash.

Custom Autosound AM/FM receiver with RCA outputs and auxiliary inputs for iPod, MP3, DVD, satellite, etc. Digital clock. Also feature: Separate bass/treble/balance, seek auto tune, electronic tuning, preset stations, 4 channel RCA outputs, ISO connection.



NOTE: Sorry this radio will not fit 1957 & earlier model Studebaker & will fit only early Avanti II models with Delco radios as original equipment.

- 802355** USA-230 200 watt (4x50) with all of the above listed features for 1958-61 Studebaker cars and 1960-64 Champ pickup. **\$210.00 ea.**
- 802356** Same as above for 1962-66 Studebaker car and 1963 to early Avanti II originally equipped with Delco radio. **\$210.00 ea.**
- 802357** USA-630 300 watt (4x75) with all of the above listed features for 1958-61 Studebaker cars and 1960-64 Champ pickup. Also includes controller for iPod and CD changer and RDS/RDBS radio tuner. **\$290.00 ea.**
- 802358** Same as above for 1962-66 Studebaker car and 1963-early Avanti II originally equipped with Delco radio. **\$290.00 ea.**

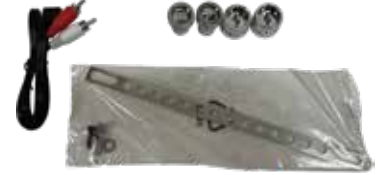

PRE-WAR & EARLY POST-WAR

- 802249** 6" round **\$55.95 ea.**
- 802250** 8" round **\$55.95 ea.**

ORIGINAL TYPE SPEAKERS



- 800618** Replacement original type 5"x7" speaker. All models with front or rear 5"x7" speaker. **\$39.95 ea.**
- 800619** Replacement original type 4"x10" speaker. All models with front or rear 4"x10" speaker. Does not fit behind Avanti dash. **\$39.95 ea.**



- 802233** Avanti's have little space inside the dash between the speaker and radio. Regular size speakers are too thick to fit. These slim 4"x10" speakers easily fit. **\$94.00 ea.**
- 802247** Replacement original type 4"x8" speaker. 1957-60 sedan, 1957-63 Hawk. Truck: 1960-64 Champ. **\$49.95 ea.**

RADIO DELETE PLATES



- 1312456WP** 1956 sedan **\$45.00 ea.**
- 1320479P** 1957 sedan **\$45.00 ea.**
- 1326658** 1958 Hawk **\$45.00 ea.**
- 1326660P** 1958 sedan **\$24.00 ea.**
- 1331630P** 1959 Lark **\$18.00 ea.**
- 1336820** 1960 Lark **\$26.00 ea.**
- 1342656** 1962 Daytona & Cruiser **\$28.00 ea.**
- 1342658** 1961-62 Lark. Except 1962 Daytona & Cruiser **\$26.00 ea.**
- 1342828** 1962-Early 63 Hawk **\$28.00 ea.**
- 1351588** Late 1963 Hawk. Wood grain **\$28.00 ea.**
- 1360648** 1964 Hawk **\$35.00 ea.**
- 1362049X1** Late 1966, all models. Wood grain **\$28.00 ea.**
- 1655438X1** 1960-64 Champ truck . **\$45.00 ea.**

REAR SPEAKER & MESH

- 1540513** Fits 5"x7" speaker. Original option on most 1956-64 models & 1963-64 Avanti. **\$30.00 set**



TRUCK SPEAKER GRILLE

- 1692469** 1961-1964 Champ truck speaker grille (includes housing, screen & clock hole cover) **\$94.00 ea.**

DASH INSTRUMENT GLASS

- 513607** 1941-48 M-series truck & all 1941 car **\$40.00 ea.**
- 536868** 1955 except Speedster **\$42.00 ea.**



STEREO SPEAKERS

These dual stereo speakers fit into the standard openings in your dash or rear shelf. This is a "no modification" solution to having great stereo sound in your Studebaker without cutting extra holes. Upgraded speaker assemblies are mounted on quarter inch material with cloth over speakers and pre-wired to plug into radio.



- 800192** For 4"x10" openings. 1961-66 Lark dash, 1962-63 Hawk dash. 1964-66 rear shelf. Does not fit Avanti. **\$59.95 ea.**



- 800193** For 5"x7" openings. Used on rear shelf most models. **\$39.95 ea.**

SPEAKER ENCLOSURE

- AC-2948** Speaker extension enclosure. 1959-60 Lark. Truck: 1960-64 Champ. For models with radio and clock. **\$8.00 ea.**



- 676657** Early 2R truck with type A instruments **\$40.00 ea.**
- 680008** Late 2R truck with type B instruments **\$40.00 ea.**



FACEPLATES



536738 all 1955 with wraparound windshield with manual tuning. Chrome with red script.....
.....\$45.00 ea.



1540346 For AC-2748, 1956-57 Hawk with manual tuning.....\$49.50 ea.



1547359 1959-60 Lark and 1960-1964 Champ truck.....\$20.00 ea.



1551990 1961 Lark.....\$50.00 ea.

1554561 1962 Lark.....\$20.00 ea.



1565777X1 1966 car. Wood grain...\$24.00 ea.



As Always,
feel free to
call us at
(317) 462-3124
to find parts
that are not

listed. Not seeing a part doesn't necessarily mean we don't have it. It could simply be the stock is limited to a few on hand and we knew it wouldn't be available shortly after this catalog was printed.

AVANTI AM-FM

Instructions

800078 Radio instructions. 1963-early Avanti II with factory AM-FM. Came in glove box when car was new.....\$3.50 ea.



A.



B.



B. **533849** Left & right outer chrome knob. 1953-55.....\$28.00 ea.



1540369 Right inner knob. 1956-57 on models without rear speakers. Pictured above right.....\$22.00 ea.



1540370 Left inner knob. 1956-57 car. Right inner knob on models with rear speaker. Pictured above, left.....\$22.00 ea.



1543617 Control knob. 1957 Packard.....\$16.00 ea.



1552542 Tone control knob. 1960-1964 push button for champ trucks.....\$17.50 ea.



1554491 Tone knob. 1962 car.....\$12.50 ea.



1554492 Dummy knob. 1962 car.....\$12.50 ea.



1545251 Knob, tone control. 1958-61 car.....\$25.00 ea.



1545252 Dummy knob. 1958 sedan. 1959-61 Lark & Hawk. Truck: 1960-64 Champ Chrome.....\$5.00 ea.



1692668 1957-1964 C-cab truck dummy knob.....\$10.00 ea.

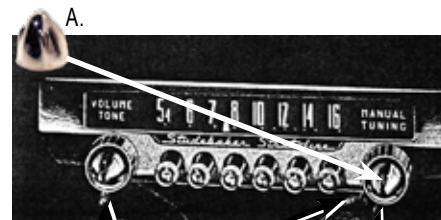

A.

D.



C.



B.

A. **802059** Left & right chrome knob. 1950-52.....\$26.00 ea.

B. **802060** right chrome knob. 1951-52 with push button tuning.....\$16.00 ea.

C. **802061** right chrome knob. 1950 manual & push button tuning and 1951-52 with manual tuning.....\$30.00 ea.

D. **802062** left chrome knob. 1950-52.....\$30.00 ea.

INSTALLATION KITS



Includes:
2 suppression capacitors for coil & regulator
1 suppression capacitor for generator
4 speaker mounting nuts & washers
1 radio support bracket
1 cable with fuse holder

1550662 1960 Lark. Also includes: Hood ground strap and fuse. Pictured left.....\$35.00 ea.

1553800 1961 Lark.....\$35.00 ea.

1556442 1962 Hawk with push button radio.....\$45.00 ea.

ANTENNAS & RELATED PARTS

770045 Antenna retaining nut. 1963-Early Avanti II. Can also be purchased in antenna kit AC-3330 **\$19.95 ea.**

770046 Antenna retaining nut. 1958 sedan and 1956-64 Hawk. Will also fit earlier Hawks. Can also be purchased in antenna kit AC-2886..... **\$26.00 ea.**

800036 Rubber pad that fits under the antenna. 1963-Early Avanti II. Can also be purchased in antenna kit AC-3330 **\$3.50 ea.**

800556 Chrome antenna base. 1958 sedan and 1956-64 Hawk. Will also fit earlier cars. Can also be purchased in antenna kit AC-2886 **\$45.00 ea.**

800582 Antenna base mounting pad. 1958 sedan and 1956-64 Hawk. Will also fit earlier Hawks. Can also be purchased in antenna kit AC-2886 **\$2.50 ea.**

800583 Antenna retaining nut. 1953-55 C & K and 1956-64 Hawk. Will fit earlier cars with twin antennas. Can also be purchased in AC-2838 kit. **\$29.95 ea.**

800971 Pad for front antenna with 1-1/4" mount..... **\$3.50 ea.**

801214 Cable for rear deck, rear twin or Avanti antenna..... **\$44.00 ea.**

1548898 1962-1964 Champ truck antenna inner base support spacer..... **\$3.50 ea.**

800952 Adjustable fender mount replacement antenna attaches to left or right front fender and plugs into original radio. Includes cable & pad..... **\$14.95 ea.**

AC-2838 Twin rear antenna kit for 1953-55 C & K models and 1956-64 Hawk. Excellent quality reproduction of original factory accessory. Includes everything needed for left and right antennas, cable and installation instructions **\$299.00 set**

AC-2886 Rear deck lid antenna kit. Excellent quality reproduction of the original factory accessory for all 1958-64 Hawk. Will also work on earlier models and 1958 sedan. Complete kit includes all hardware, cable and mounting instructions. **\$220.00 ea.**

AC-3330 Manual radio antenna. Avanti 1963 - Early Avanti II. Complete and ready to install with nut and pad. Does not include cable.. **\$206.00 ea.**

INSTRUMENT SURROUNDS

1358553

1352786W

652220 Instrument panel gasket, rubber. All 1949-64 C-cab truck..... **\$15.00 ea.**

1352786W Rim, instrument cluster. 1963-66 Lark. Chrome..... **\$95.00 ea.**

1355257 1963-66 Lark, basic models. Silver .. **\$45.00 ea.**

1358553 Rim & instrument mounting plate. 1964-66 Challenger & basic models... **\$65.00 ea.**

1655324 Instrument cluster panel. C-cab 5E-8E **\$22.00 ea.**

1953 INTERIOR PAINT

801925 All 1953 cars had Loma Gray instrument panels and window trim. 11 oz. can **\$14.65 ea.**



RADIO PARTS

1332769 Radio mounting bracket for radio delete plate. 1959 - 60 Lark. Truck: 1960-64 Champ **\$12.00 ea.**

1540715 Cable. Radio to ignition switch with fuse holder. 1956-57 car..... **\$10.00 ea.**

1543772 Switch with cables for rear speaker. 1957 Packard **\$26.00 ea.**

1545263 Switch with cables for rear speaker. 1958-59 car **\$26.00 ea.**

1549682 Switch, rear speaker. 1960-61 Lark.... **\$26.00 ea.**

1552561 Switch with knob for rear speaker. 1961-62 car, 1959-60 Lark ... **\$26.00 ea.**

1555125 Switch with knob for rear speaker. 1962 Lark **\$26.00 ea.**

1555189 Cable, rear speaker to switch. 1962 Lark **\$15.00 ea.**

1555190 Cable. Rear speaker switch to radio. 1962 Lark..... **\$18.00 ea.**

1555554 Cable. Radio to ignition switch with fuse holder. 1963 Lark & 1962-64 Hawk..... **\$12.00 ea.**

1556108 Switch, rear speaker. 1962 Hawk..... **\$45.00 ea.**

1559223 Capacitor. Optional 45 or 60 amp alternator. 1963-64 car. **\$12.00 ea.**

1559774 Cable for rear speaker to radio. 1963-64 Hawk..... **\$16.00 ea.**

HORN BUTTON RETAINERS

519179 Retainer "O" ring. 1947-52.....**\$2.00 ea.**

532902 Retainer "O" ring. 1953-56 car, all models.....**\$2.00 ea.**

1541971 Retainer "O" ring. 1957-66 car, all models.....**\$7.25 ea.**



HORN BUTTONS

199938X1 1941-48 M-series truck.....**\$77.00 ea.**



682756 1949-53 2R truck. Tan background.....**\$59.00 ea.**



682758 1949-53 2R truck. Red background..
.....**\$59.00 ea.**



800760 1953-55. Gold with "S" center. Reproduction.....
.....**\$50.00 ea.**



1539835 1956 Champion, Commander, Flight Hawk, Power Hawk. 1957 Champion. NOS.....**\$55.00 ea.**



1546599 1958 Packard, all models. Gold bird with gold background. NOS.
.....**\$75.00 ea.**



Note for above horn button: Would fit any 1957-61 Hawk!

1554640 1962 Lark.....**\$125.00 ea.**

DASH PLAQUES

15-035 No Smoking plaque with "Studebaker" logo. 1-1/2" X 3". Pictured.....**\$5.00 ea.**



15-035A No Smoking plaque with "Hawk" logo. 1-1/2" X 3".....**\$5.00 ea.**
15-035B "Thank You For Not Smoking" dash plaque with Avanti logo.....**\$5.00 ea.**



770047 "Avanti Quality Built Expressly For _____" 1964-91 dash plaque.

Take to your jeweler to engrave your name.....
.....**\$6.00 ea.**



770048 "Avanti Quality Built Expressly For _____" 1963 dash plaque. Take to your jeweler to engrave your name.....
.....**\$6.00 ea.**

.....**\$6.00 ea.**

800013 "Studebaker Quality Built Expressly For _____" plaque. Take to your jeweler and have your name engraved in space provided. 1 1/4"X3 1/2".....**\$6.00 ea.**



800031 "Gran Turismo Hawk Quality Built Expressly For _____" plaque. Take to your jeweler and have your name engraved in space provided. 1 1/4"X3 1/2".....**\$6.95 ea.**

800050 Fasten Seat Belt plaque with "Studebaker" logo. 1 1/2"X3"
.....**\$5.00 ea.**

800050A Fasten Seat Belt plaque with "Hawk" logo. 1 1/2"X3".....**\$5.00 ea.**

800050B "Please Fasten Seat Belt" dash plaque with Avanti logo.....**\$5.00 ea.**

DIRECTIONAL & HI-BEAM INDICATOR LIGHT TUBE & LENS ASSEMBLY

802484 1956-1961 Hawk : Improved one piece assembled design over 6 piece original design.....**\$25.00 ea.**



HORN BUTTON PLASTIC LENS

800044 1960-66 Lark, 1960-64 pickup, 1960-64 Hawk. Clear plastic lens cover easily replaces your original and glues in place.....**\$9.50 ea.**



LARK DASH, ASHTRAY PADDED COVERS

1343204X1 Black. 1962 Lark.....**\$20.00 ea.**
1343204X5 Blue. 1962 Lark.....**\$20.00 ea.**

1343204X6 Green. 1962 Lark.....**\$20.00 ea.**

1343204X7 Taupe. 1962 Lark.....**\$20.00 ea.**

1354104X3 Green. 1963 Lark.....**\$25.00 ea.**

1354104X4 Chestnut. 1963 Lark.....**\$25.00 ea.**

1354104X6 Brown. 1963 Lark.....**\$25.00 ea.**

1354104X7 Blue. 1964-65 Lark.....**\$25.00 ea.**

1354104X8 Green. 1964-65 Lark.....**\$25.00 ea.**

1354104X11 Blue. 1966 Lark.....**\$25.00 ea.**

DASH RETAINING CLIPS

1350675 Avanti Dash retaining clip. Takes 11.....**\$3.00 ea.**



DASH MAT

800484R Dash mat protective dash cover. 1963-85 Avanti. Made of high quality carpet, these mats protect your dash from the sun's damaging rays and cover cracks in a worn dash. Avanti name is embroidered on cover. Available in multiple colors and includes Velcro adhesive mounting strip. Please specify color when ordering.....**\$95.00 ea.**

800484T 1986-92 Avanti Touring Coupe.....**\$95.00 ea.**



DASH BOARDS

Complete fiberglass panels

1326650 1958-59 Hawk.....**\$225.00 ea.**

1337216 1960-61 Hawk.....**\$225.00 ea.**

1351408 1963 Hawk.....**\$225.00 ea.**



TRUCK DASH OVERLAY

1655512 Upper dash cover. 1955-64 C-cab truck. Moulded just like the original. Paintable black plastic. **\$139.95 ea.**

DASH MOULDINGS

1353847 Far left plate. 1963-64 Lark. **\$10.25 ea.**
1354090 End cover. Right. 1963-64 Lark. Pictured **\$20.00 ea.**
1354091 End cover. Left. 1963-64 Lark **\$20.00 ea.**

DASH COVER PADS

1315216X2 1956-59 Hawk. Black vinyl cover. Includes pad. **\$55.00 ea.**
1332512X1 1959 Lark. Black. **\$65.00 ea.**
1334322X1 1960 Hawk, black. Black vinyl cover. Includes pad. **\$71.00 ea.**
1334322X5 1961 Hawk, black. Black vinyl cover. Includes pad. **\$119.95 ea.**
1334375X1 1960 Lark & 1960 - 61 T-cab truck. Black **\$65.00 ea.**
1343942X61 Left retainer Moulding. 1962-63 Hawk **\$15.00 ea.**
1343944X61 Right retainer Moulding. 1962-63 Hawk **\$15.00 ea.**
1344882 1962-63 Hawk. Black vinyl with electro-plated seams. **\$45.00 ea.**
1656164X1 1962 T-cab truck. Black. **\$75.00 ea.**
1656379X1 1963-64 T-cab truck. Black. **\$99.00 ea.**

PADDED DASH COVERS

for 1961-62 Lark. Just like the original.



1340161X1 Black. 1961-62 **\$375.00 ea.** **1340161X4** Brown. 1961-62 **\$375.00 ea.** **1340161X7** Taupe. 1962 **\$375.00 ea.**
1340161X2 Blue. 1961 **\$375.00 ea.** **1340161X5** Blue. 1962 **\$375.00 ea.** **1340161X8** Red. 1962 **\$375.00 ea.**
1340161X3 Green. 1961 **\$375.00 ea.** **1340161X6** Green. 1962 **\$375.00 ea.**



AVANTI DASH PAD

1350520X1 1963-1983 Avanti. Fawn. **\$910.00 ea.**
1350520X2 1963-1983 Avanti. Black. **\$910.00 ea.**

GLOVE BOX PADDED COVER



1352690X4 Chestnut. 1963 Lark Regal, Custom, Daytona, Cruiser. NOS **\$85.00 ea.**
1354240X2 Blue. 1963 Lark police, taxi, Standard. NOS. **\$85.00 ea.**
1354240X3 Green. 1963 Lark police, taxi, Standard. NOS. Picture above **\$85.00 ea.**

1354240X4 Chestnut. 1963 Lark police, taxi, & Standard. NOS. **\$85.00 ea.**
1360074X3 Green. 1964-65 Lark Challenger, police. NOS. **\$85.00 ea.**
1360075X3 Green. 1964-66 Lark Commander, Daytona, Cruiser. NOS **\$85.00 ea.**



1962 LARK DASH, LOWER PADDED COVER

Left Side*

1343202X1 Black
1343202X4 Brown
1343202X6 Green
1343202X8 Red
 **\$36.25 ea.**



**Note: These left lower pads are for a right hand drive car but will turn over and work perfectly on a left hand drive vehicle.*



ARM REST PADS

292351X6 Padded interior door handle and arm rest for many 1949-52 Champion and Commander models. Truck: 1949-64 C-cab. Available in black rubber only. Includes inner pad but does not include mounting bracket. NOS. **\$45.00 ea.**
1334153X8 Left side, Green, 1963-1964 Champ truck **\$70.00**



1347788 1963 Avanti left or right **\$22.50 ea.**

AVANTI VINYL DYE



Makes faded or discolored vinyl look like new. Convenient and easy to use 11 oz. can.

800188X2 Turquoise **\$14.65 ea.**
800188X3 Fawn. On 1963 models used on dash & top of door panels. **\$14.65 ea.**
800188X4 Elk **\$14.65 ea.**
800188X5 Red **\$14.65 ea.**



Black: If your Avanti has a black interior, our black vinyl closely matches the original grain to make your interior look as rich as it did when new.

Elk: A popular color for seats in both 1963 & 1964, our replacement Elk vinyl closely resembles the original in both color and grain.

- 800209X1** Black \$969.00/Set
- 800209X2** Turquoise..... \$969.00/Set
- 800209X3** Orange \$969.00/Set
- 800209X4** Elk \$969.00/Set
- 800209X5** Claret Red \$969.00/Set
- 800209X6** Metallic Red \$1,129.00/Set

Our replacement front bucket & rear seat covers are made to the highest standard of quality. Made to original factory specifications, these covers possess a grain and color similar to the original. All bottom cushion covers have the same "pockets" sewn in as was done by Studebaker. All covers are made to order, so allow 30 days for delivery. Only colors listed are available at this time. Inquire for availability of other colors.

1962-64 GT HAWK

- 802510X1** Black. \$915.00 set
- 802510X2** Blue. \$915.00 set
- 802510X3** Green. \$915.00 set

- 802510X4** Taupe. \$915.00 set
- 802510X5** Red..... \$915.00 set

- 802510X6** Tan \$915.00 set
- 802510X7** Brown \$915.00 set



RUBBER FLOOR COVERS

Includes Jute pad

- 800820R** Front only. 1947-50 Champion or Commander with standard transmission . **\$195.00 ea.**
- 800822R** Truck: 1941-48 M-series..... **\$269.95 ea.**
- 800823R** Truck: 1949-59 C-cab with column shift. **\$218.40 ea.**



CARPET SETS - Excellent quality carpet sets for most model cars and trucks.

These fine quality sets:

- Requires cutting of throttle, brake & clutch pedal holes, as well as master cylinder or automatic transmission filler opening when required.
- Are made with heel pads that duplicate the original used by Studebaker.
- Includes jute padding.

To order, state the year, model, and firewall tag number of your car, desired color, and type (loop or cut-pile). Please allow 30 days for delivery. Carpet sets are made to order and are not returnable.

AVANTI

800197R Complete carpet set. Solid colors. Original style 1963 salt & pepper carpet is not available. **\$549.00/18 piece set**

802240R Deluxe set. Deeper pile as used in Avanti II. (ONLY IN BLACK)..... **\$664.00/14 piece set**

Note: Please specify car's year, serial number, if car has air conditioning, and the desired carpet color.

Includes Hawk **C & K 1953-64**

800264R Carpet. Front & rear floors & panel below rear seat. **\$459.00/set**

1947-66 All except C & K & truck

800265R Carpet. Front & rear floors **\$408.00/set**

TRUCK 1960-64 CHAMP

800584R Carpet, floor cover **\$333.00/set**

EXTRA CARPET YARDAGE

801215R If you need extra carpet yardage for firewall, kick pads, door panels rear shelf, trunk, etc. Comes in 40" width. Please specify color when ordering **\$45.00 yd.**

802300 Extra wide carpet yardage. Sold in half yards. Comes in 80" wide **\$44.00 ½ yd.**

802301 Deluxe cut-pile carpet yardage. (ONLY IN BLACK) **\$110.00 yd.**



RUBBER FLOOR MAT

Peter Pillipow's 1950 Commander



Front rubber floor mats with "Studebaker" logo molded in attractive black mat with inlaid carpet of optional colors. A very nice addition to your sedan, Hawk or truck that not only looks good, but protects your carpeting too.

Rear mats without logo. Not recommended for C & K body cars
 \$39.95 pr.



800099 Black rear



800100 Red rear



800101 Blue rear



800102 Tan rear

800093 Front floor mat,
 Blue front \$79.95 pr.



**CALL &
 PLACE YOUR ORDER
 TODAY!
 (317) 462-3124**

REAR FLOOR MATS



802470X1 Black 1963-1985 Avanti and 1961-1966 Lark types
 \$100.00 ea.



802470X2 Red/Vermillion 1963-1985 Avanti and 1961-1966 Lark types
 \$100.00 ea.



802470X3 Tan/Elk 1963-1985 Avanti and 1961-1966 Lark types
 \$100.00 ea.



802470X4 Turquoise 1963-1985 Avanti and 1961-1966 Lark types.....
 \$100.00 ea.

FRONT FLOOR MATS



1963-1985
 Avanti and
 1961-1966
 Larks

- 802447x1** Black rubber floor mats \$125.00 pr.
- 802447x2** Red/Vermillion rubber floor mats \$125.00 pr.
- 802447x3** Tan/Elk rubber floor mats \$125.00 pr.
- 802447x4** Turquoise rubber floor mats \$125.00 pr.

SILL PLATES & Mounting Hardware



- 303584-5** 1953-57 C & K model. Can also be cut down and used on 4 -dr. sedan 1953-55. Excellent quality reproduction with correct bend **\$239.00 pr.**
- 1337290** 1960-1964 Champ truck (NOS)..... **\$125.00 pr.**
- 1337293** 1958-66 2-door sedan & Lark. Stainless. **\$99.00 pr.**
- 1337295** Rear. 1958-61 4-door sedan. Stainless **\$71.50 pr.**
- 1337296** Rear. 1958 President Classic, 1961 Cruiser, & 1962 4 door sedan rear. Stainless **\$71.50 pr.**
- 1337298** 1958-64 Hawk. Stainless. **\$99.00 pr.**
- 1343782** 1958-Early 66 4-door sedan & station wagon. Front. Stainless. Truck: 1960-64 Champ. **\$99.50 pr.**



- 1351136-7** Right & left sill plates. 1963 Avanti up to serial number R4879. Rubber. Pictured above. **\$295.00 pr.**
- 1350690** Outer stainless moulding. 1963 Avanti. Pictured below with close up view. **\$26.50 ea.**
- 1353802** Rear. 1963-66 4-door sedan & station wagon **\$99.00 pr.**



SILL PLATE HARDWARE

1526X47 Screw, sill plate mounting. All models except Avanti. Chrome oval head **25¢ ea.**

1526X58 Mounting screw 8-15 & 3/4" for 1963 Avanti. Takes 24..... **25¢ ea.**

2049X20 Screw, for 1350690. Need six for one side. **15¢ ea.**



1347846 moulding, kick pad retainer, 1963-85 Avanti. Stainless... **\$24.50 ea.**

RUBBER HOUNDSTOOTH PATTERN TRUNK MAT

Very similar to original material that was used from 1963-65. Excellent quality, rubber - not vinyl! Includes tire cover.

- 802392** 1953-64 C&K (includes Hawk). **\$135.00**
- 802360** 1959-61 Lark..... **\$155.00**
- 802361** 1962-63 Lark..... **\$135.00**
- 802362** 1964-66 Lark. **\$115.00**

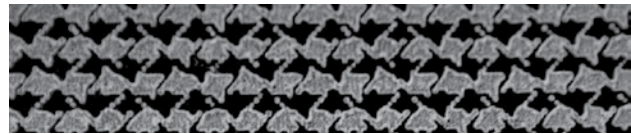

TRUNK MATS

801236 1949-52 car. Rubber. Pictured inside Peter Pillipow's Studebaker, top right..... **\$107.20 ea.**

801258 1947-48 car. Rubber..... **\$75.00 ea.**

Note: The following trunk mat & spare tire covers come in a heavy vinyl material with the original gray and black houndstooth pattern. All are cut to fit just like the original.



1340427X1 1959-61 Lark **\$75.00 ea.**

1346626X1 1953-64 C & K. Includes Hawk. Pictured right **\$75.00 ea.**

1346637X1 1962-63 Lark **\$75.00 ea.**

1359042X1 1964-66 Lark..... **\$75.00 ea.**

Original owners, Gary & Alice Baty's 1961 Hawk

TRUNK LINERS

Large cardboard separator that goes between the back seat and the trunk.

- 299774** 1953-55 C & K **\$45.00 ea.**
- 802106** 1941-46 Champion..... **\$45.00 ea.**
- 802107** 1947-52 sedan **\$45.00 ea.**
- 1313246** 1956-57 C & K **\$45.00 ea.**
- 1313432** 1956-58 sedan..... **\$55.00 ea.**
- 1329324** 1958-64 C & K **\$55.00 ea.**
- 1333004** 1959-60 Lark..... **\$55.00 ea.**
- 1340097** 1961 Lark. **\$55.00 ea.**
- 1344004** 1962-66 Lark **\$55.00 ea.**



Peter Pillipow's 1950 Commander

AVANTI TRUNK LINERS

800200 Avanti replacement trunk liner & tire cover. Close match to the original black material. 1963-64. **\$351.00 ea.**

800709R Avanti deluxe carpet liner for trunk as used on 1966-89 models. Please specify color needed when ordering. **\$376.00/set**

HEADLINER SETS - TRUCK



- 800824R** Truck: 1941-48 M-series. Tan. Includes kick pads & door panels. **\$521.00 set ***
- 800825R** Truck: 1949-54 C-cab Standard colors are: tan, gray, off white, red, and black. **\$362.00 set***
- 800826R** Truck: 1955-64 C-cab. Standard colors are: tan, gray, off white, red, and black **\$362.00 set ***
- 800827R** Truck: 1960-64 Champ. Vinyl. **\$246.00 ea.****
- 800827RX1** Truck: 1960-64 Champ. Cloth **\$245.00 ea.****

***Available for immediate shipment.**
****Allow 4-5 weeks for delivery.**



PANEL CLIPS

- 1917X3** Clip. Door panel retainer. 1953-66 car most models. Also on Avanti - Adheres headliner side pads to roof. **75¢ ea.**
- 648667X1** Clip, door panel. M-series truck . Takes 36. **85¢ ea.**

TRUCK INTERIOR

- 790123** 3-piece set - headliner, side panel & above rear window panel. Tan. 1960-64 Champ **\$80.00 set/3**
- 801545** Door panel, tan. 1941-48 M-series truck... **\$135.00 pr.**

FRONT KICK PANELS

- 800832R** Available for all models cars & Champ truck. **\$39.95 pr.**
- 1347666-7** Early 1963 Avanti **\$43.00 pr.**
- 1347860-1** Late 1963 Avanti - Avanti II. **\$43.00 pr.**
- Note: Choose from: red, blue, dark green, off white, black, gray, brown & tan.**

- 801549** 1941-48 M-series, tan **\$59.95 pr.**
- Note: Most kick panels are available for immediate shipment. State color when ordering. We cannot match every factory color but this material is easily paintable.**

DOOR PANEL FOUNDATION

- 801666** Cardboard backing for door panels. 1953-64 K-body hardtop includes Hawk **\$80.00 pr.**
- 801667** Cardboard backing for rear of door panels. 1953-64 K-body hardtop includes Hawk **\$60.00 pr.**
- 802471** 1947-1952 Convertible **\$61.75 pr.**
- 802472** 1947-1952 4-Door Front **\$74.00 pr.**
- 802473** 1947-1952 4-Door Rear **\$74.00 pr.**
- 802474** 1949-1952 Land Cruiser 4-Door Front **\$61.75 pr.**
- 802475** 1950-1951 2-Door Sedan Door & Rear Quarter Board Set **\$135.50 set/4**
- 802476** 1951-1952 Land Cruiser 4-Door Rear **\$61.75 pr.**
- 802503** 1953-61 coupe rear quarter **\$66.00 pr.**
- 802504** 1953-61 coupe door **\$69.00 pr.**
- 802505** 1959-62 Lark Hardtop door **\$69.00 pr.**
- 802506** 1959-62 Lark Hardtop rear quarter **\$69.00 pr.**

HEADLINER CLIP

- 1326885** 1958-66 sedan & J-body hardtop except 1956 Sky & Golden Hawks, 1963-66 Avanti and 1963-66 Wagonaire with sliding roof. Truck: 1960-64 Champ **\$2.25 ea.**

AVANTI ROLL BAR COVER

Without Moon Roof 1963-65 Avanti



1347499 Roll bar cover retaining clip. Takes 6 **\$2.50 ea.**

- 800476R** New manufactured plastic cover looks identical to original but is firm rather than padded. Please specify color when ordering. Available in fawn, turquoise, elk, black and red **\$110.00 ea.**

REPLACEMENT WINDLACE



This woven cloth windlace closely resembles the original.

NOTE: Please state color when ordering and remember that dye lots vary sometimes significantly. We recommend requesting a sample. Call customer service at 317-462-3124.

- 801204R** **\$4.50 ft.**
- Note: An extra 1" of cloth or vinyl must be sewn on to replacement windlace for certain applications when extra depth is required to secure windlace tab.**

ORIGINAL STYLE WINDLACE

- Woven plastic windlace for 1960-66 Lark, Hawk, and Champ truck. Has 1" wire tab for proper installation & correct 3/4 diameter. **\$4.00 ft.**

- 801673** Red **\$4.00 ft.**
- 801810** Windlace, black vinyl. Truck: 1949-64 C-cab..... **\$3.25 ft.**

VINYL MATERIAL

- 800853** Blue, original vinyl. 48" wide. 1963-65, Lark or Hawk (some cleaning of material is required before install) **\$45.00 yd.**

DOOR ARM REST COVER UPHOLSTERY

- 800218-9** 1963-1964 Avanti door arm rest cover upholstery. Specify color when ordering. **\$92.00 pr.**

REAR QUARTER ARM REST COVER UPHOLSTERY

- 800220-1** 1963-1964 Avanti rear quarter arm rest cover upholstery. Specify color when ordering. **\$122.00 pr.**

Studebaker Gift Certificates

Always a Great Idea!
Available in any Amount!
No Expiration Date!

HEADLINER - CAR

Available in cloth or vinyl for most years and models.
Perforated white available for GT Hawks.

- 800363R** 1928-58 sedan. Vinyl **\$359.95 ea.**
- 801674R** 1928-58 sedan. Cloth **\$375.95 ea.**
- 802287** Vinyl. 1959-66 sedan and 1953-64 C & K car, including Hawk. **\$259.95 ea.**
- 802287CNVRSN** 1956 Golden Hawk conversion to bow-type headliner **\$406.95 ea.**
- 802288** Cloth. 1959-66 sedan and 1953-63 C & K car, including Hawk **\$375.95 ea.**
- 802289** Vinyl. 1954-62 station wagon & 1963-66 station wagon with fixed roof only **\$399.95 ea.**
- 802290** Cloth. 1954-62 station wagon & 1963-66 station wagon with fixed roof only **\$399.95 ea.**

Note: 1956 Golden Hawk headliner conversion available upon request.

Note: Some models require removal of the windshield & back glass for proper headliner installation. Check your shop manual for instructions for your car. Replacement windshield & rear glass seals are available on page 55.

Note: Please specify year, model & color when ordering. For specific matches send sample. Please allow 3 weeks for delivery. Headliners are made to order and are not returnable.

1963-83 AVANTI HEADLINER

- 800531** Headliner, without moon roof, front & rear. Looks identical to original but made of strong fiberglass that retains its shape and stays in place **\$195.00 set**

CONTROL KNOBS, HANDLES, & RELATED PARTS



- 291209X1** Upper wiper knob. 1950-53 car. Tan.....**\$15.20 ea.**
- 291209X2** Upper wiper knob. Late 1958 Scotsman with dash mounted switch. Black.....**\$15.20 ea.**
- 291209X3** Upper wiper knob. 1953 car. Gray.....**\$15.20 ea.**

Wiper knob. 1955 car with wraparound windshield.



- 310149** Type - A.....**\$12.95 ea.**
- 536781** Type - B.....**\$12.95 ea.**



- 287981X1** "W" knob for wiper control in 1947-48 car.....**\$25.00 ea.**

- 519124X1** "L" gold button. Goes on 522786 knob for headlights in 1947-48 car.....**\$9.50 ea.**

- 522782X1** "F" knob for fog light control in 1947-48 car.....**\$12.50 ea.**

- 522783X1** "A" knob for air control in 1947-48 car.....**\$10.00 ea.**

- 522785X1** Defroster switch plug 1947-48 Car (without defroster).....**\$15.00 ea.**

- 522786X1** Headlight knob (needs 519124X1 gold button to be complete.) 1947-48 car.....**\$12.50 ea.**

- 522805** Overdrive knob and cable. 1947-48 car.....**\$45.00 ea.**

- 525450X1** Headlight knob. 1949 car all models.....**\$26.95 ea.**



- 526162** Air.....**\$18.00 ea.**
- 526163** Instrument & Map.....**\$18.00 ea.**
- 526164** Defrost.....**\$18.00 ea.**



- 526226** Air. 1950 Champion.....**\$20.00 ea.**
- 526227** Defrost. 1950 Champion.....**\$20.00 ea.**
- 526230** Headlight. 1950 Champion.....**\$20.00 ea.**

- 530153** Heater. 1951 car, all models.....**\$15.00 ea.**



- 531717W** Headlight knob. 1952 car, all models.....**\$40.00 ea.**

- 531718W** Heater knob. 1952 car, all models.....**\$15.00 ea.**

- 531720W** Push start knob. 1952 car, all models.....**\$15.00 ea.**

- 534019** Control knob for remote control antenna 1953-66 Car.....**\$27.50 ea.**

- 1339270X1** Knob, fresh air intake. 1961-66 Lark.....**\$8.50 ea.**

- 1351089** handle, air vent control. 1963 Avanti. Chrome. Takes 2.....**\$22.00 ea.**

- 1351214W** handle, heater temperature control. 1963 Avanti. Chrome.....**\$20.00 ea.**

- 1351215W** handle, defroster control. 1963 Avanti. Chrome.....**\$20.00 ea.**

- 1539888** Black head lamp, wiper, or fan knob. 1956 sedan & wagon, 1959-61 Lark. Truck: 1957-64.....**\$8.50 ea.**

- 1540033** Black wiper knob. 1957-58 sedan & Hawk 1957-1962.....**\$12.50 ea.**

- 1540531** Knob for headlights or wipers. 1956 President sedan & wagon. Black with metallic gold center.....**\$8.50 ea.**

- 1543617** Chrome head lamp, wiper, fan. 1957-58 Packard. 1959-60 Lark Regal.....**\$16.00 ea.**

- 1549590** White headlight, wiper, fan. 1960 & 1962 Lark.....**\$8.50 ea.**

- 1554118** Black wiper knob. 1959 & 1961 Lark Deluxe. Truck- 1962-64 All. Includes set screw.....**\$12.50 ea.**

**Please call
(317) 462-3124 if you don't see the knob
you're looking for!**

- 1554974** White wiper knob. 1962 Lark. Includes set screw.....**\$12.50 ea.**

- 1560516W** "Heat", 1963-66 Lark, chrome.....**\$8.00 ea.**

- 1560517W** "Def", 1963-66 Lark, chrome.....**\$8.00 ea.**

KNOB ESCUTCHEONS

- 1547327** "Lights". 1959-62 Lark.....**\$7.00 ea.**
- 1552176** "Wiper". 1961-62 Lark.....**\$7.00 ea.**
- 1552177** "Fan". 1961-62 Lark.....**\$7.00 ea.**
- 1552178** Escutcheon, heater valve control. 1961-62 Lark.....**\$7.00 ea.**

- 1557358** Escutcheon. Avanti wiper knob.....**\$20.00 ea.**

TURN SIGNAL LEVERS & KNOBS

- 800838** Black knob. 1956-61 & 1966 all models.....**\$12.00 ea.**

- 800839** White knob. 1962-65 all models & 1963-70 Avanti w/o tilt wheel.....**\$12.00 ea.**

- 801241** Tan knob. 1950-52 all models.....**\$12.00 ea.**

- 535371** Lever, Loma Gray with tan knob. 1953-55 car. Truck: 1949-64 various models. See chassis manual to determine your application.....**\$30.00 ea.**

- 681729** Lever, chrome. Truck: 25 3E, 4E, various applications. Please see your chassis manual to determine application.....**\$26.00 ea.**

- 1550921** Lever, chrome with black knob, 1956-60 car.....**\$35.00 ea.**

- 1552456** Lever, chrome with black knob, 1961 and 1966 Lark. Truck: 1961-64 Champ.....**\$35.00 ea.**

- 1555280** Lever, chrome with white knob, 1962-65 car.....**\$35.00 ea.**

SCREW KITS

Assortment of special screws for inside and outside. Contains many hard to find sizes and most are stainless steel. Includes parking and tail lens screws. Very handy to have when working on your car and a nice replacement for rusty original screws.

- 15-025** 1962-64 Gran Turismo Hawk.....**\$32.00 ea.**

- 15-025A** 1953-55 hardtop (K-body) and 1956-58 Hawk hardtop.....**\$32.00 ea.**

- 15-025B** 1953-61 Hawk coupe.....**\$26.00 ea.**

- 15-026** Avanti.....**\$34.00 ea.**

- 15-027** 1955 car with curved windshield to 1966 sedan. Includes Lark.....**\$32.00 ea.**

GLOVE BOX LOCKS

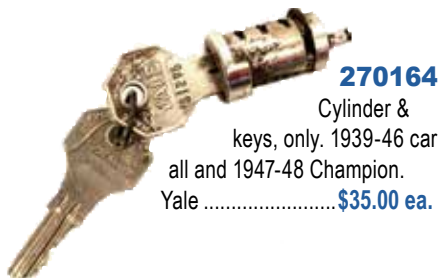

270164 Cylinder & keys, only. 1939-46 car all and 1947-48 Champion. Yale **\$35.00 ea.**

286124 Lock & housing. Includes cylinder and keys. 1947-48 Champion. Yale **\$65.00 ea.**

286681 Lock & housing. Includes cylinder & keys. 1947-48 Commander and 1947 Champion. Hurd **\$35.00 ea.**



290722 Lock & housing. Includes cylinder & keys. 1949 Champion. Yale **\$45.00 ea.**

290723 Lock & housing. Includes cylinder and keys. 1949-50 Commander & Land Cruiser. Will also fit Champion for these years. Hurd **\$40.00 ea.**

293770 Lock & housing. Includes cylinder and keys. 1951-52 Commander & Land Cruiser .. **\$40.00 ea.**

298082 Lock & housing. Includes cylinder and keys. 1953-54 all car, 1955 President & Land Cruiser. All without wraparound windshield including C & K. Hurd. **\$35.00 ea.**

298083 Lock & housing. Includes cylinder and keys. 1953-54 all car, 1955 President & Land Cruiser. All without wraparound windshield including C & K. Yale **\$40.00 ea.**

1353821 Lock & housing. Includes cylinder and keys. 1963 Lark **\$40.00 ea.**

1360846 Same as 1362033 except it uses a 2-groove key as opposed to the 3-groove keys used on 1362033 **\$35.00 ea.**

1362033 Lock & housing. Includes cylinder and keys. 1955 all with wraparound windshield. 1956-62 car except 1957-58 Scotsman. Also fits 1960-64 Hawk & 1960-64 truck **\$35.00 ea.**

GLOVE BOX LINERS



269087 1937-38 Commander, 1938 President **\$42.00 ea.**

GLOVE BOX KEYS

290635 1947-55 with Yale lock **\$8.00 pr.**

1343378 1960-63 all models including Avanti **\$8.00 pr.**



1360849 1964-66 all models including Avanti ... **\$8.00 pr.**



GLOVE BOX RELATED PARTS

298825 Lens, glove box light. 1953-58 car, 1959-66 most cars, 1963- Early Avanti II **\$22.50 ea.**



306746X1 Clip, glove box retainer. 1953-66 sedan. Includes Lark **\$3.00 ea.**



653415X61 Door, glove box. Truck: 3-R - 2E **\$47.50 ea.**

1351434 Lens, glove box light. 1963 Lark **\$15.00 ea.**



1654396 Knob, glove box, 1956-64 C-cab truck **\$4.75 ea.**



271302 1939-40 Champion **\$55.00 ea.**



284650 1947-49 Champion & Commander **\$44.85 ea**



291020 1950-52 Champion & 1951-52 Commander **\$40.55 ea.**



291035 1950 Commander **\$34.30 ea.**



298060 1953-55 car, all models except 1955 sedan with wraparound windshield. **\$36.75 ea.**



311417 1955 sedan with wraparound windshield **\$34.00 ea.**



648858 Truck: 1941-48 M-series **\$41.60 ea.**



1312246 1956-58 sedan **\$36.20 ea.**



1332574 1959-60 car, all. Truck: 1960-64 Champ **\$39.00 ea.**



1343314 1961-62 Lark **\$39.00 ea.**



1360042 1964-66 Lark **\$37.80 ea.**



1360043 1964-66 Sedan (RHC) **\$40.00 ea.**

GLOVE BOX BUMPERS

278986 1947-53 car all models. **\$1.50 ea.**

287427 1949-64 C-cab truck. Takes 4 **\$3.00 ea.**

287528 1946-64 C-cab truck. Takes 1 **\$4.00 ea.**



309343 1955-62 all models & 1956-64 Hawk & T-cab trucks .. **\$1.00 ea.**

1323102 1957-58 Packard **\$2.00 ea.**

ASHTRAYS



AC-1445 Rear ashtray kit. 1947-52 4-dr Custom & Deluxe. Also includes two screws....**\$45.00/kit**

652933 Dash mounted ashtray. Truck: 1949-64 C-cab.... **\$45.00 ea.**



652934 Slider assembly for 652933 ashtray. **\$25.00 ea.**

1312369 Slider assembly for dash mounted ashtray. 1956-60 sedan. Truck: 1960-64 Champ .. **\$20.00 ea.**

1312370 Dash mounted ashtray. 1959-60 sedan. Truck: 1960-64 Champ **\$45.00 ea.**



1339019 Dash mounted ashtray. 1961-62 Lark. Pictured **\$35.00 ea.**



1314879 Handle, rear plastic ashtray. 1956 4-dr sedan..... **\$18.00 ea.**



1314882X2 Faceplate, rear ashtray. Mounted on back of (nonfolding) front seat, 1956 4-dr sedan. **\$15.00 ea.**



1323384W Handle, rear chrome ashtray. 1957-58 Packard..... **\$25.00 ea.**

If you don't see the Ashtray accessory you need here, please call 317-462-3124. The item you may want might simply be available in a quantity too limited to list.

1333579 Rear ash collecting tray. Mounted on back of bench (nonfolding) front seat. 1959-60 Lark w/bench. **\$22.00 ea.**



1333592X1 Complete rear ashtray. Mounted on the back of bench (nonfolding) front seat. 1959-60 Lark..... **\$38.25 ea.**

1340324X1 Rear ashtray mounted on the back of bench (nonfolding) front seat, 1961-66 Lark **\$36.00 ea.**



1333595X1 Faceplate for rear ashtray mounted on the back of bench. (nonfolding) front seat 1959-60 Lark **\$15.00 ea.**



1333596W Handle. Mounted on ashtray located on the back of bench (nonfolding) front seat. 1959-66 car. Chrome **\$15.00 ea.**

1339022 Slider assembly for 1339019 ashtray **\$15.00 ea.**



1340326 Rear ash collecting tray. Mounted on back of bench (nonfolding) front seat. 1961-66 4 door **\$26.00 ea.**



1340327X1 Faceplate for rear ashtray. Mounted on the back of bench (nonfolding) front seat. 1961-66 Lark..... **\$15.00 ea.**

1340346 Retainer for rear ashtray 1340326 mounted on back of bench (nonfolding) front seat. 1961-66 Lark **\$20.00 ea.**



1347718W Retainer for 1347714W ashtray.... **\$20.70 ea.**



1352822 Front ash collection tray. 1963-66 Lark..... **\$32.50 ea.**



1355040 Heat shield. 1963-66 Lark. Fits above ashtray on dash and protects padded cover. Stainless **\$12.50 ea.**



1750144 Rear ashtray. 1974-85 Avanti **\$28.00 ea.**

24 Hour Shopping
www.studebaker-intl.com

CIGARETTE LIGHTER RELATED PARTS

G454176 Plug. Cigar or cigarette lighter. Chrome **\$2.50 ea.**



278416 Lighter fuse. All years & models. 6 volt or 12 volt. Also 1963-64 & early Avanti II **\$8.25 ea.**



802285 Black knob and element. 1956-61 car, all models..... **\$38.00 ea.**



802286 White knob and element. 1962-63 car, all models except Avanti..... **\$38.00 ea.**

FIREWALL LINERS

298747 1953-62 C & K includes Hawk.....	\$142.00 ea.	1347540 & 1347794 1963 -64 Avanti.....	\$89.95 pr.
800828 Truck: 1941-48 M-series.....	\$148.00 ea.	1347540X1 1966-80 Avanti.....	\$86.00 ea.
800829 Truck: 1949-64 C-cab.....	\$142.00 ea.	1354375 1963 Lark.....	\$145.95 ea.
801934 1950 car.....	\$142.00 ea.	1354395 1963-64 Hawk.....	\$125.00 ea.
801935 1951-52 car.....	\$142.00 ea.	1359044 1964 Lark.....	\$125.00 ea.
1324100 1953-58 sedan w/curved windshield.....	\$107.25 ea.	1361400 1965-66 Lark.....	\$125.00 ea.
1333385 1959-60 Lark. Truck: 1960 Champ.....	\$125.00 ea.	1655734 Truck: 1961-62 Champ.....	\$125.00 ea.
1340330 1961 Lark.....	\$125.00 ea.	1656376 Truck: 1963-64 Champ.....	\$125.00 ea.
1344340 1962 Lark.....	\$125.00 ea.		

1347794

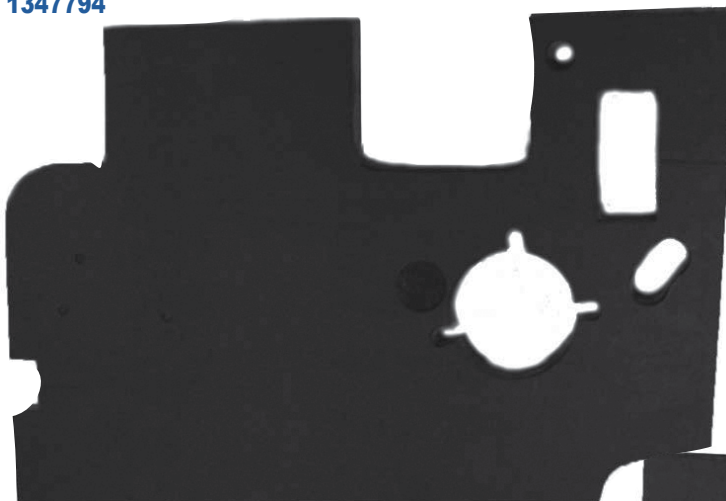

FIREWALL RETAINER CLIP

307029X11 Retainer clip, most models except Avanti..... \$3.00 ea.



1347540

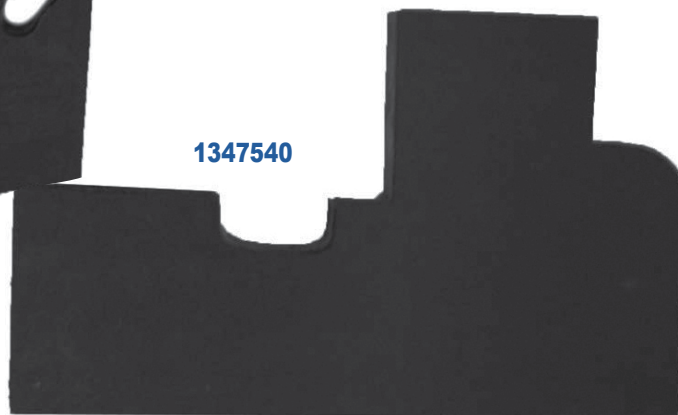

Note: All firewall liners are black; but, can easily be painted for those models with color.

*Can't find the part you're looking for?
Call & we'll be glad to look for a part just for you!*

(317) 462-3124

We welcome overseas customers!

MAP LIGHT LENS



291106 Lens for map light. 1950-52 car.....
.....\$16.00 ea.

COURTESY LENS



1321895 Interior light lens. 1958-66, all models & 1963-78 Avanti.....\$14.50 ea.

OVERHEAD SWITCH NAMEPLATES



1351119 1963 Avanti.....\$38.50 ea.
1358767 1964-83 Avanti.....\$38.50 ea.

DOOR & WINDOW SEAL, SPACER & ESCUTCHEONS

267313 Spring goes under door and window handles. 1947-66 2 door front, 1947-66 4 door front and rear.....**\$3.00 ea.**

272985 Escutcheon, 1940 Commander & President offwhite, plastic**\$10.00 ea.**

278943X1 Escutcheon. 1939-41 Champion. Truck: 1941-48 M-series. Ivory.....**\$13.85 ea.**

289290 Escutcheon. 1948 Champion Deluxe. Ivory.....**\$12.00 ea.**

289191X3 Escutcheon. 1950-52 Champion & Commander. Tan..... **\$12.00 ea.**

310844 Seal for door & window handles. 1953-66 car, all models. Truck: 1960-64 Champ..... **\$2.00 ea.**

652242 Spacer, door & window handle. Truck: 1949-64 C-cab..... **\$2.00 ea.**

1312647 Spacer. 1956-66 car, all models. Fits between door or window handle and escutcheon. Truck: 1960-64 Champ..... **\$2.00 ea.**

1319242 Escutcheon. 1958 car, all models. 1963-71 Avanti Aluminum.....**\$20.35 ea.**

1333574 Escutcheon. 1959-66 Lark & Hawk. Truck: 1960-64 Champ. These plastic escutcheons fit between the handles and the door panel..... **\$3.50 ea.**

Escutcheon. Avanti door lock on door panel. Chrome.

1350188W Right.....**\$30.00 ea.**
1350189W Left.....**\$30.00 ea.**

DOOR & WINDOW ESCUTCHEON KIT FOR 1959-66 LARK & 1959-64 HAWK



Kit includes: Enough Parts for 2 window handles and 2 door handles

- **1333574** 1959-66..... escutcheon (4)
- **1312647** 1959-60..... spacer (4)
- **1334393** 1961-66..... spacer (4)
- **310844** 1959-66..... seal (4)

Total of all parts if Purchased separately **\$26.00**

801566 1959-60 car. Special package Price**\$21.90/kit**
801566X1 1961-66 car & 1960-64 truck.

Special package Price**\$21.90/kit**

Note: For 4 door models order 2 kits.

INTERIOR DOOR HANDLES

271959W 1939-46 Champion. Truck: 1941-48 M-series. Chrome.....**\$79.95 ea.**

652203 Inside chrome door handle. 1949-64 C-cab truck.....**\$40.00 ea.**

G456326 Attaching screw**25¢ ea.**

1312640X1 Interior door handle. 1956-66 car and 1960-64 Champ truck.....**\$41.50 ea.**

1358711W Beautiful chrome finish, interior door handle. 1964-85 Avanti.....**\$89.95 ea.**

DOOR LOCK LEVERS

G156617 Screw for 1358712W or 1350414W ... **25¢ ea.**

1350414W Inside door lock lever. 1963 Avanti ... **\$36.00 ea.**

1350415W Escutcheon under 1350414W or 1358712W Avanti door lock lever**\$18.00 ea.**

1358712W Inside door lock lever, 1964 Avanti & some Avanti II models**\$19.20 ea.**

LOCK LEVERS

297803X6 Black. 1956-62 all models. 1956-64 Hawk. Truck: 1960-64 Champ**\$6.00 ea.**

DOOR & WINDOW HANDLE REMOVAL TOOL



800523 1956-66, all models. Goes underneath each handle to release clip for easy removal..... **\$5.95 ea.**

DOOR & WINDOW HANDLE CLIP

1312646 Inside door handle retaining clip. 1963-85 Avanti. Also used as a window crank handle clip for all 1956-66 models and 1963-1985 Avanti.....**30¢ ea.**

ANTI-RATTLE GROMMET

For door lock rod

304771 1953-66 car, all models. Truck: 1960-64 Champ**\$1.00 ea.**

PLEASE NOTE: Sometimes there is an additional shipping charge for items drop shipped in these kits (usually for headliners and carpet sets).

1941-48 M-SERIES TRUCK

194562 Brake & clutch pedal seals (2).....	\$5.00 ea.
271959W Chrome. Interior door handle. (2).....	\$79.95 ea.
278943X1 Door handle escutcheons (4).....	\$13.85 ea.
513536X1 Gas pedal boot.....	\$7.00 ea.
648667X1 Door panel clips (36).....	85¢ ea.
648858 Glove box insert.....	\$41.60 ea.
675269 Brake & clutch pedal pads (2).....	\$18.00 ea.
800822R Floor mat.....	\$269.95 ea.
800824R Headliner, kick and door panel kit, Tan.....	\$521.00/kit
Total of all parts included if purchased separately.....	\$1,131.45
Special Kit Price.....	\$1,075.00/kit
-10% quantity discount. See page 6.....	\$107.50
801567 Your cost.....	\$967.50/kit



1949-54 C-CAB TRUCK with column shift

287427 Glove box bumpers (4).....	\$3.00 ea.
287528 Glove box bumper. (1).....	\$4.00 ea.
513536X1 Gas pedal boot.....	\$7.00 ea.
515645X2 Shifter knob, Black.....	\$20.45 ea.
652203 Interior door handle (2).....	\$40.00 ea.
652204 Window crank handle (2).....	\$64.00 ea.
652242 Door & window handle spacer. (4).....	\$2.00 ea.
675269 Brake & clutch pedal pads (2).....	\$18.00 ea.
800823R Floor mat.....	\$218.40 ea.
800825R Headliner kit, complete. Standard colors are; tan, gray, off white, red, and black.....	\$362.00/kit
801535-801541 or 801982-801984 Seat Belts, special emblem, total length 72". Choice of color (2).....	\$39.20 ea.
Total of all parts included if purchased separately.....	\$1,074.25
Special Kit Price.....	\$1,022.00/kit
-10% quantity discount. See page 6.....	\$102.20
801569 Your cost.....	\$919.80/kit



Note: Additional shipping charges apply to drop shipped items in interior kits.

1962-64 GT HAWK

15-025 Screw kit.....	\$32.00/kit
304771 Door lock anti-rattle seal (2).....	\$1.00 ea.
310844 Door & window handle seals (6).....	\$2.00 ea.
513536X1 Gas pedal boot.....	\$7.00 ea.
535117 Gas pedal.....	\$25.25 ea.
800004, 800025-800030 Seat belts (4).....	\$35.85 ea.
800031 Original dash plaque.....	\$6.95 ea.
800264R Carpet.....	\$440.00/set
802287 Vinyl headliner.....	\$259.95 ea.
800832R Kick pads.....	\$39.95 pr.
800837R Rear shelf.....	\$38.95 ea.
801204R Replacement windlace.....	\$73.70/set
1312640X1 Inside door handle. (2).....	\$41.50 ea.
1312643X3 Window crank handle w/white knob (4).....	\$57.00 ea.
1334393 Door & window handle spacers (6).....	\$2.00 ea.
1333060-1W Chrome metal hinge covers.....	\$110.00 pr.
1333574 Door & window handle escutcheons (6).....	\$3.50 ea.
1337298 Sill plates.....	\$99.00 pr.
1339259X1 Interior chrome rearview mirror.....	\$71.75 ea.
1344444 Visor clips (2).....	\$3.50 ea.
1346528-9 Sunvisors.....	\$215.00 pr.
Replacement Upholstery Choice of color: 802510X4 Taupe.....	\$980.00 set
802510X1 Black.....	\$980.00 set
802510X2 Blue.....	\$980.00 set
802510X3 Green.....	\$980.00 set
802510X5 Red.....	\$980.00 set
802510X6 Tan.....	\$980.00 set
802510X7 Brown.....	\$980.00 set
Total of all parts included if purchased Separately.....	\$3,150.55
Special Kit Price.....	\$2,995.00
-15% quantity discount. See page 6.....	\$449.25
801571 Your cost.....	\$2,545.75/Kit



Note: For Windlace upgrade see page 38.

1955-59 C-CAB TRUCK with Column shift

287427 Glove box bumpers (4).....	\$3.00 ea.
287528 Glove box bumper.....	\$4.00 ea.
513536X1 Gas pedal boot.....	\$7.00 ea.
515645X2 Shifter knob, Black.....	\$20.45 ea.
652203 Interior door handle, (2).....	\$40.00 ea.
652204 Window crank handle (2).....	\$64.00 ea.
652242 Door & window spacers (4).....	\$2.00 ea.
675269 Brake & clutch pedal pads (2).....	\$18.00 ea.
680280 Gas pedal.....	\$32.50 ea.
800813-800819 or 801976-801978 72" Seat belts. (2). Choice of color.....	\$39.20 ea.
800823 Floor mat.....	\$218.40 ea.
800826R Headliner kit, complete. Standard colors are; tan, gray, off white, red, and black.....	\$362.00/kit
1655512 Upper dash cover.....	\$139.95 ea.
Total of all parts included if purchased separately.....	\$1,246.70
Special Kit Price.....	\$1,185.00/kit
-10% quantity discount. See page 6.....	\$118.50
801570 Your cost.....	\$1,066.50/kit



NOTE: For Windlace upgrade see page 38.



NOTE: Additional shipping charges apply to drop shipped items in interior kits.

1959-61 HAWK

15-025B Screw kit.....	\$26.00/kit	1312643X1 Window crank handle w/black knob. (2).....	\$39.00 ea.
304771 Door lock anti-rattle seal (2).....	\$1.00 ea.	1312647 Door & window spacers (6).....	\$2.00 ea.
310844 Handle seals (4).....	\$2.00 ea.	1319182-3 Sunvisors.....	\$215.00 pr.
800004, 800025-800030 Seat belts (4).....	\$35.85 ea.	1333060-1W Chrome metal hinge covers.....	\$110.00 pr.
800264R Carpet.....	\$440.00/set	1333574 Door & window handle escutcheons (4).....	\$3.50 ea.
802287 Headliner. Vinyl.....	\$259.95 ea.	1337298 Sill plates.....	\$99.00 pr.
800832R Kick pads.....	\$39.95 pr.	Total of all parts included if purchased separately.....	\$1,941.10
800835R Rear shelf.....	\$33.95 ea.	Special Kit Price.....	\$1,845.00/kit
801204R Replacement windlace.....	\$73.70/set	-15% quantity discount. See page 6.....	\$276.75
1312640X1 Inside door handle (2).....	\$41.50 ea.	801572 Your cost.....	\$1,568.25/kit

1959-1966 LARK 4-DR

1332574 Glove box liner (1959-60).....	\$39.00 ea.
1343314 Glove box liner (1961-62).....	\$39.00 ea.
1360042 Glove box liner (1964-66).....	\$37.80 ea.
1337295 Rear sill plates (1959-61).....	\$71.50 pr.
1353802 Rear sill plates (1963-66).....	\$99.00 pr.
15-027 Screw kit.....	\$32.00/kit
304771 Door lock anti-rattle seal (4).....	\$1.00 ea.
310844 Handle seals (8).....	\$2.00 ea.
800004, 800025-800030 Seat belts (4).....	\$35.85 ea.
800013 Dash plaque.....	\$6.00 ea.
800265R Carpet.....	\$391.00 ea.
802287 Headliner. Vinyl.....	\$259.95 ea.
800832R Kick pads.....	\$39.95 pr.
800836R Rear shelf.....	\$33.95 ea.
801204R Replacement windlace (38').....	\$152.00/38 ft.
1312640X1 Interior door handle. (4).....	\$41.50 ea.
1312643X1 window crank handle (4). 1959-61 & 1966 w/black knob.....	\$39.00 ea.
1312643X3 window crank handle (4). 1962-65 w/white knob.....	\$57.00 ea.
1312647 Door & window spacers (8).....	\$2.00 ea.
1319182-3 Sunvisors.....	\$215.00 pr.
1333574 Door & window handle escutcheons (8).....	\$3.50 ea.
1343782 1958-Early 66 front sill plates.....	\$99.00 pr.
1344444 Visor clips (2).....	\$3.50 ea.

Total of all parts included if purchased separately..... \$2,280.10

Special package price\$2,168.00/kit

-15% quantity discount. See page 6..... \$325.20

801573 Your cost.....\$1,842.80/kit

1959-1966 LARK 2-DR

1332574 Glove box liner (1959-60).....	\$39.00 ea.
1343314 Glove box liner (1961-62).....	\$36.00 ea.
1360042 Glove box liner (1964-66).....	\$34.75 ea.
15-027 Screw kit.....	\$32.00/kit
304771 Door lock anti-rattle seal (4).....	\$1.00 ea.
310844 Handle seals (8).....	\$2.00 ea.
800004, 800025-800030 Seat belts (4).....	\$35.85 ea.
800013 Dash plaque.....	\$6.00 ea.
800265R Carpet.....	\$391.00 ea.
802287 Headliner. Vinyl.....	\$259.95 ea.
800832R Kick pads.....	\$39.95 pr.
800836R Rear shelf.....	\$33.95 ea.
801204R Replacement windlace (38').....	\$152.00/38 ft.
1312640X1 Interior door handle. (4).....	\$41.50 ea.
1312643X1 window crank handle (4). 1959-61 & 1966 w/black knob.....	\$39.00 ea.
1312643X3 window crank handle (4). 1962-65 w/white knob.....	\$57.00 ea.
1312647 Door & window spacers (8).....	\$2.00 ea.
1319182-3 Sunvisors.....	\$215.00 pr.
1333574 Door & window handle escutcheons (8).....	\$3.50 ea.
1337293 Sill plates.....	\$99.00 pr.
1344444 Visor clips (2).....	\$3.50 ea.

Total of all parts included if purchased separately..... \$1,986.60

Special package price\$1,888.00/kit

-15% quantity discount. See page 6..... \$283.20

802296 Your cost.....\$1,604.80/kit



WINDOW CRANK HANDLES, KNOBS & RELATED PARTS

1312643 Knob, only. 1956-61 car all models, 1966 all models, Truck: 1960-64 Champ. Black **\$4.50 ea.**



1312643X3 Window crank handle with white knob. 1962-65 Lark & Hawk. 1963-64 Avanti & Early Avanti II. Will also substitute on other models with black knobs **\$57.00 ea.**



652204 Inside chrome window crank handle with black plastic knob. 1949-64 C- cab truck **\$64.00 ea.**

1954X1 Attaching screw **25¢ ea.**

1353706 Adapter, rear window crank to regulator. 1963-66 Wagonaire **\$22.00 ea.**



1312643X1 Window crank handle with black knob. 1956-61 car, all models. 1966 all models. Truck: 1960-64 Champ. Will also substitute on other models with white knobs **\$39.00 ea.**

WINDOW ROLLERS & CLIPS

281089 Washer. Window regulator arm to glass. 1947-64 most models except 1963-64 sedans and wagons **\$.50 ea.**

285030 Clip. Window regulator arm to glass. 1947-64 most models except 1963-64 sedans and wagons **\$1.50 ea.**



1350837 Roller & clip. 1963-66 Lark. 1963-85 Avanti. Takes 2 per door .. **\$3.00 ea.**



1350838 Retainer clip for 1350837 roller. Also 1963-66 station wagon tailgate **20¢ ea.**



4-DOOR ELECTRIC WINDOW REGULATORS

310124 Rear right door regulator. 1955-58 long wheelbase sedan with power windows **\$175.00 ea.**

310126 Rear right. door regulator. 1955-58 short wheel base sedan with power window **\$175.00 ea.**

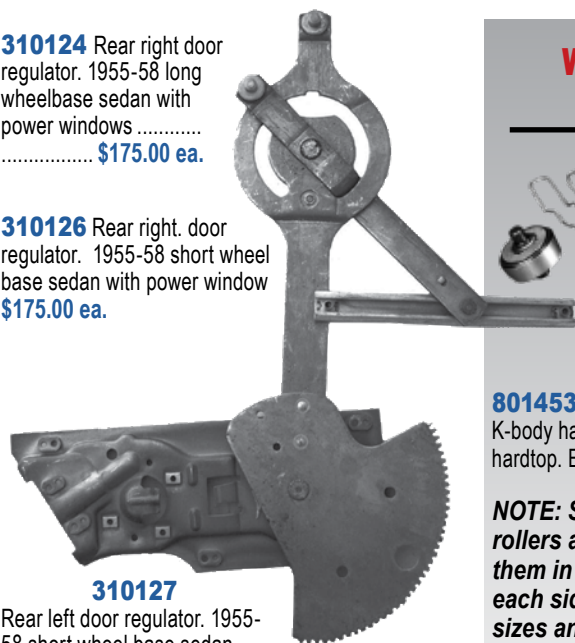

310127 Rear left door regulator. 1955-58 short wheel base sedan with power windows **\$175.00 ea.**

2-DOOR ELECTRIC WINDOW REGULATORS

310729 Left door regulator. 1955-58 K - body hardtop **\$175.00 ea.**

WINDOW ROLLER & CLIP KIT



801453 Roller & clip kit. 1953-64 K-body hardtop & 1947-52 convertible & hardtop. Enough for 2 doors **\$79.90 ea.**

NOTE: Side windows have 5 special rollers and 3 special clips to hold them in place. Of the 5 rollers on each side, there are 3 different sizes and of the 3 clips there are 2 different styles. This kit includes 10 rollers and 6 clips, enough for one car & all the rollers and clips are the correct size.

750077 Retainer clips only. Set of 6. Enough for 2 doors **\$10.50/set 6**

WINDOW REGULATORS

Right Door for 2-door or Right Front for 4-door

281096 Right. 1941 2-door & 1942-46 Commander & President **\$80.00 ea.**

265339 Right front. 1937 4-door **\$90.00 ea.**

270812 Right front. 1939-40 Champion **\$90.00 ea.**

273700 Right front. 1940 all except Champion **\$90.00 ea.**

284842 Right or Right front. 1947-48 all 2-door & 4-door cars except convertible **\$124.25 ea.**

284844 Right front. 1947-48 4-door sedan **\$70.00 ea.**

286660 Right front. 1947-48 Land Cruiser **\$80.00 ea.**

286748 Right. 1947-48 2-door convertible **\$80.00 ea.**

289790 Right or Right front. All 1949-52 2-door & 4-door except convertible **\$205.00 ea.**

289794 Right. 1949-52 2-door convertible **\$125.00 ea.**

289796 Right front. 1949-52 Land Cruiser **\$80.00 ea.**

307312 Right or Right front. 1953-55 2-door & 4-door sedan & wagon. 1956-57 F2 & W2 sedan **\$80.00 ea.**

307316* Right. 1953-55 C & K coupe & hardtop. NOS **\$210.00 ex.**

652580 1949-64 C-cab truck **\$100.00 ea.**

1314350 Right or Right front. 1956-61 2-door & 4-door sedan & wagon. 1956-58 coupe & K-body hardtop. Truck: 1960-61 pickup **\$90.00 ea.**

1327430 Right. 1959-61 hardtop & convertible **\$130.00 ea.**

1331716* Right. 1959-63 Hawk. Rebuilt exchange - the shaft is slightly shorter **\$210.00 ex.**

1343100 Right or Right front. 1962 sedan & wagon. Truck: 1962-64 **\$115.50 ea.**

****1343354*** Right. 1962-63 J-body hardtop or convertible. Rebuilt exchange **\$205.00 ex.**

1352602 Right front. 1963-66 sedan & wagon **\$120.00 ea.**

1360872* Right. 1964 Hawk. Rebuilt exchange - the shaft is slightly shorter **\$210.00 ex.**

****1360888*** Right. 1964 J-body hardtop or convertible. Rebuilt exchange **\$205.00 ex.**

***We must have your old regulators prior to shipping. Please send your order with your old regulators.**

****Please remove Idler before shipping core.**

DOOR WINDOW GUIDE STUD

274438 All 1941-64 trucks except Champ; All 1941-42 Commander & President; All 1941-46 Champions (4-door cars use 8, 2-door cars use 4). Rear quarter windows: 1953-58 K Body hardtops (4 per car) **\$5.95 ea.**

274439 Inner leather washer for above window guide stud, takes 2 per window **\$3.75 ea.**

280789 Spring washer for above application **\$2.50 ea.**

280821 Outer leather washer for above application **\$3.50 ea.**

WINDOW REGULATORS

Left Door for 2-door or Left Front for 4-door

*Must have your old regulators prior to shipping. Send your order with your old regulators.

**Please remove Idler before shipping core.



- 265340** Left front. 1937 4-door. **\$90.00 ea.**
- 266807** Left or Left front. 1938-39 2-door or 4-door car except Champion. **\$90.00 ea.**
- 270813** Left front. 1939-40 Champion **\$90.00 ea.**
- 273701** Left front. 1940 all except Champion **\$80.00 ea.**
- 281097** Left front. 1941 2-door & 1942-46 Commander & President. **\$80.00 ea.**
- 284843** Left or Left front. 1947-48 all 2-door & 4-door cars except convertibles. **\$124.25 ea.**
- 284845** Left front. 1947-48 4-door sedan. **\$70.00 ea.**
- 286661** Left front. 1947-48 Land Cruiser. **\$90.00 ea.**
- 286749** Left. 1947-48 2-door convertible. **\$90.00 ea.**
- 289791*** Left or Left front. All 1949-52 2-door & 4-door except convertible. Rebuilt exchange. **\$205.00 ex.**
- 289795** Left. 1949-52 2-door convertible. Rebuilt Exchange. **\$210.00 ex.**
- 289797** Left front. 1949-52 Land Cruiser. **\$90.00 ea.**
- 307313*** Left or Left front. 1953-55 2-door & 4-door sedan & wagon. 1956-57 F2 & W2 sedan. Rebuilt exchange. **\$205.00 ex.**
- 307317*** Left. 1953-55 coupe & hardtop. Rebuilt exchange. **\$305.00 ex.**
- 310123** Left front. All 1955-58. 4-door with power windows. **\$192.25 ea.**
- 652581** 1949-64 C-cab truck. **\$175.00 ea.**
- 1314351*** Left or Left front. 1956-61 2-door & 4-door sedan & wagon. 1956-58 coupes & K-body hardtop. Truck: 1960-61 truck. NOS. Rebuilt exchange. **\$150.00 ex.**
- 1327431*** Left. 1959-61 hardtop & convertible. Rebuilt exchange. **\$205.00 ex.**
- 1331717*** Left. 1959-63 Hawk. Rebuilt exchange -the shaft is slightly shorter. **\$210.00 ex.**
- 1343101** Left or Left front. 1962 sedan & wagon. Truck: 1962-64 Champ. **\$115.50 ea.**
- **1343355*** Left. 1962-63 J-body hardtop or convertible. Rebuilt exchange. **\$205.00 ex.**
- 1352603*** Left or Left front. 1963 2-door & 4-door sedan. Rebuilt exchange. **\$205.00 ex.**
- 1360427*** Left or Left front. 1964 2-door & 4-door sedan. Rebuilt exchange. **\$205.00 ex.**
- 1360873*** Left. 1964 Hawk. Rebuilt exchange -the shaft is slightly shorter. **\$210.00 ex.**
- **1360889*** Left. 1964 J-body hardtop or convertible. Rebuilt exchange. **\$205.00 ex.**
- 1361047*** Left or Left front. 1965-66 2-door & 4-door sedan. Rebuilt exchange. **\$210.00 ex.**

RIGHT REAR DOOR - WINDOW REGULATOR FOR A 4-DOOR CAR

- 263122** Right rear. 1936-37 4-door. **\$80.00 ea.**
- 266807** Right rear. 1938-39 4-door Except Champion. **\$90.00 ea.**
- 270822** Right rear. 1939-40 4-door Champion. **\$80.00 ea.**
- 281042** Right rear. 1941 4-door Champion. **\$90.00 ea.**
- 282124** Right rear. 1942 4-door Champion. **\$90.00 ea.**
- 286662** Right rear. 1947-48 Land Cruiser. **\$60.00 ea.**
- 289792** Right rear. 1949-52 4-door sedan. **\$60.00 ea.**
- 289798** Right rear. 1949-52 Land Cruiser. **\$124.25 ea.**
- 307320** Right rear. 1954-55 4-door sedan & 1956-57 W2 custom sedan. **\$112.75 ea.**
- 1314354** Right rear. 1956-61 W1-W4-W6-4-door sedan. Used as left rear regulator on 1956-61 long wheelbase sedan & 1962 long wheelbase sedan & Cruiser. **\$112.75 ea.**
- 1336260** Right rear. 1962 long wheelbase 4-door sedan except late models. Also 1960-62 wagon. **\$105.00 ea.**
- 1352600** Right rear. 1963 4-door. **\$120.00 ea.**
- 1358230** Right rear. 1964-66 4-door. **\$120.00 ea.**

LEFT REAR DOOR - WINDOW REGULATOR FOR A 4-DOOR CAR

- 263123** Left rear. 1936-37 4-door. **\$80.00 ea.**
- 270823** Left rear. 1939-40 4-door Champion. **\$90.00 ea.**
- 281043** Left rear. 1941 4-door Champion. **\$90.00 ea.**
- 282125** Left rear. 1942 4-door Champion. **\$90.00 ea.**
- 286663** Left rear. 1947-48 Land Cruiser. **\$124.25 ea.**
- 289793** Left rear. 1949-52 4-door sedan. **\$60.00 ea.**
- 289799** Left rear. 1949-52 Land Cruiser. **\$124.25 ea.**
- 307321** Left rear. 1954-55 4-door sedan & 1956-57 W-2 custom sedan. **\$113.00 ea.**
- 310125** Left rear. 1955-58 long wheelbase sedan with power windows. **\$175.00 ea.**
- 1314355** Left rear. 1956-61 W1, W4, W6, 4-door sedan. Also on 1956-61 long wheelbase sedan & late 1962 long wheelbase Y-1 & Cruiser. **\$105.00 ea.**
- 1336261** Left rear. 1962 long wheelbase 4-door sedan except late Y-1 models. Also 1960-62 wagon. **\$105.00 ea.**
- 1352601** Left rear. 1963 4-door. **\$120.00 ea.**
- 1358231** LR. 1964-66 4-door. **\$120.00 ea.**

RIGHT REAR QUARTER - WINDOW REGULATOR FOR A 2-DOOR CAR

- 263123** Right rear quarter. 1936-37 2-door. **\$80.00 ea.**
- 283378** Right rear quarter. 1939-46 2-door Champion. **\$80.00 ea.**
- 285484** Right rear quarter. 1947-52 all 2-door & sedan. **\$70.00 ea.**
- 296130** Right rear quarter. 1952 K-body hardtop. **\$95.00 ea.**
- 297814** Right rear quarter. 1953-55 2-door sedan & 1956-57 F-2 sedan. **\$112.75 ea.**
- 1314356** Right rear quarter. 1956-58 F4 & F6 2-door sedan. **\$112.75 ea.**
- 1327632** Right rear quarter. 1958 J-hardtop. **\$125.00 ea.**
- 1331508** Right rear quarter. 1959-66 2-door sedan. **\$112.75 ea.**
- 1336042** Right rear quarter. 1959-63 convertible. **\$125.00 ea.**
- 1337316** Right rear quarter. for 1959-60 Lark hardtop. **\$94.00 ea.**
- 1339776** Right rear quarter. 1962-63 Lark hardtop. **\$125.00 ea.**
- 1343150** Right rear quarter. 1961 Lark hardtop. **\$125.00 ea.**
- 1343760** Right rear quarter. 1962-63 Hawk. **\$125.00 ea.**
- 1360874** Right rear quarter. 1964 Daytona hardtop. **\$120.00 ea.**
- 1360876** Right rear quarter. 1964 convertible. **\$120.00 ea.**
- 1360878** Right rear quarter. 1964 Hawk. **\$120.00 ea.**

LEFT REAR QUARTER - WINDOW REGULATOR FOR A 2-DOOR CAR

- 263122** Left rear quarter. 1936-37 2-door. **\$80.00 ea.**
- 283379** Left rear quarter. 1939-44 2-door Champion. **\$80.00 ea.**
- 285485** Left rear quarter. 1947-52 all 2-door & sedan. **\$80.00 ea.**
- 296131** Left rear quarter. 1952 K-2 hardtop. **\$95.00 ea.**
- 297815** Left rear quarter. 1953-55 2-door sedan & 1956-57 F-2 sedan. **\$112.75 ea.**
- 1327633** Left rear quarter. 1958 J-body hardtop. **\$125.00 ea.**
- 1331509** Left rear quarter. 1959-66 2-door sedan. **\$112.75 ea.**
- 1336043** Left rear quarter. 1959-63 convertible. **\$125.00 ea.**
- 1337317** Left rear quarter. 1959-60 Lark hardtop. **\$90.00 ea.**
- 1339777** Left rear quarter. 1962-63 Lark hardtop. **\$125.00 ea.**
- 1343151** Left rear quarter. 1961 Lark hardtop. **\$125.00 ea.**
- 1343761** Left rear quarter. 1962-63 Hawk. **\$125.00 ea.**
- 1360875** Left rear quarter. 1964 Daytona hardtop. **\$120.00 ea.**
- 1360877** Left rear quarter. 1964 convertible. **\$120.00 ea.**
- 1360879** Left rear quarter. 1964 Hawk. **\$120.00 ea.**

DOOR GLASS UPPER CHROME FRAME

for Convertibles and Hardtops
(Frame Only)

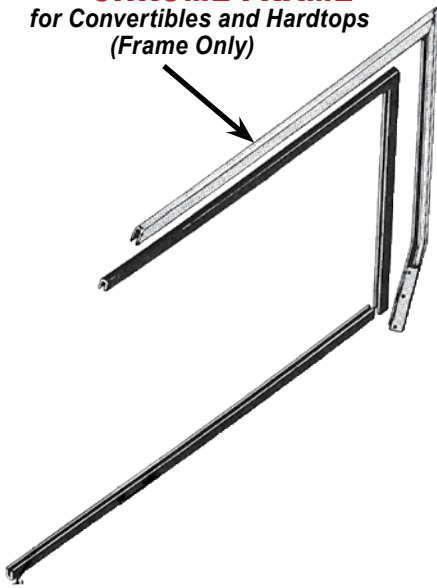

- 1343734** Right. 1962-64 G.T. Hawk. Does not include rollers **\$75.00 ea.**
- 1353688** Right. 1963-64 convertible **\$110.00 ea.**
- 1353689** Left. 1963-64 convertible **\$110.00 ea.**
- 1353694** Right. 1963 Daytona hardtop **\$110.00 ea.**
- 1353695** Left. 1963 Daytona hardtop **\$110.00 ea.**

FRONT DOOR VENT WINDOW OUTER FRAME

(Frame Only)

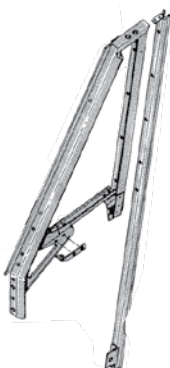

- 304478** Right. 1953-64 K-body hardtop **\$130.00 ea.**
- 304479** Left. 1953-64 K-body hardtop **\$143.00 ea.**
- 1323635** Left. 1957-62 taxi. Includes "U" channel **\$65.00 ea.**

WINDOW LIFT REPAIR CHANNEL FOR 1963-85 AVANTI

- 800140** Window lift channel. Repairs 1350734 and 1350735 channel. Must be welded in place **\$35.00 ea.**



FRONT DOOR GLASS

(Glass Only)

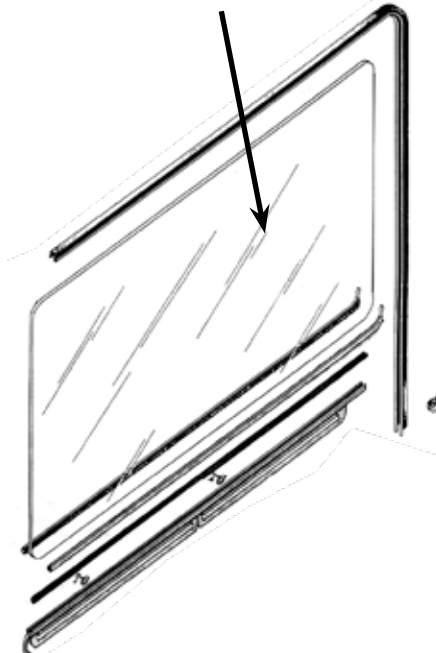

- 308590** Clear. 1955-58 4-door sedan with wraparound windshield & 1960-64 T-cab truck **\$45.00 ea.**
- 1322501** Tinted. 1959-62 4-door sedan **\$45.00 ea.**
- 1331208** Clear. 1959-62 J-body Lark hardtop **\$60.00 ea.**
- 1343741** Clear. 1962-64 G.T. Hawk **\$50.00 ea.**
- 1350724** Right, clear. 1963-89 Avanti **\$315.00 ea.**
- 1350725** Left, clear. 1963-89 Avanti **\$315.00 ea.**
- 1350726** Right, tinted. 1963-1989 Avanti **\$325.00 ea.**
- 1350727** Left, tinted. 1963-1989 Avanti **\$325.00 ea.**
- 1352633** Tinted. 1963 4-door sedan & 1963-66 station wagon. NOS **\$55.00 ea.**
- 1352634** Clear. 1963 2-door sedan .. **\$45.00 ea.**
- 1352635** Tinted. 1963 2-door sedan **\$55.00 ea.**
- *1353826** Clear. 1963 Daytona hardtop **\$70.00 ea.**
- *1353827** Tinted. 1963 Daytona hardtop **\$80.00 ea.**
- 1358038** Clear. 1964-66 2-door sedan. Limited availability. NOS **\$45.00 ea.**
- 1358039** Tinted. 1964-66 2-door sedan **\$55.00 ea.**
- *1358418** Clear. 1964 Daytona hardtop **\$60.00 ea.**

**Note: Also see "Main door windows" to the right.*

MAIN DOOR WINDOW

including Upper Frame and Lift Channel

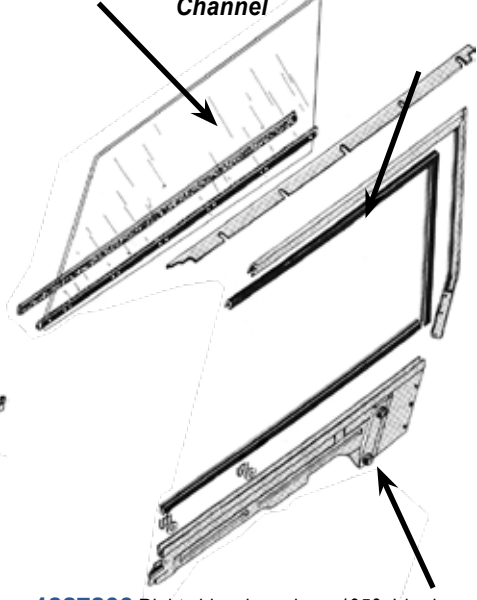

- 1327200** Right side, clear glass. 1958 J-body hardtop **\$225.00 ea.**
- 1332380** Right side, clear glass. 1959-62 hardtop Lark **\$225.00 ea.**
- 1332381** Left side, clear glass. 1959-62 hardtop Lark **\$225.00 ea.**
- 1336862** Right side, tinted glass. 1960-62 convertible **\$235.00 ea.**
- 1336863** Left side, tinted glass. 1960-62 convertible **\$235.00 ea.**
- 1343730** Right side, clear glass. 1962-64 G.T. Hawk **\$225.00 ea.**
- 1353680** Right side, clear glass. 1963 hardtop Daytona **\$260.00 ea.**
- 1353681** Left side, clear glass. 1963 hardtop Daytona **\$260.00 ea.**
- 1353682** Right side, tinted glass. 1963 hardtop Daytona **\$270.00 ea.**
- 1353683** Left side, tinted glass. 1963 hardtop Daytona **\$270.00 ea.**
- 1353684** Right side, clear glass. 1963-64 convertible **\$260.00 ea.**
- 1353685** Left side, clear glass. 1963-64 convertible **\$260.00 ea.**
- 1353686** Right side, tinted glass. 1963-64 convertible **\$270.00 ea.**
- 1353687** Left side, tinted glass. 1963-64 convertible **\$270.00 ea.**
- 1358400** Right side, clear glass. 1964 hardtop Daytona **\$260.00 ea.**
- 1358401** Left side, clear glass. 1964 hardtop Daytona **\$260.00 ea.**
- 1358402** Right side, tinted glass. 1964 hardtop Daytona **\$270.00 ea.**
- 1358403** Left side, tinted glass. 1964 hardtop Daytona **\$270.00 ea.**

SLIDING DOOR GLASS

(Glass Only)

- 1657615** 8E Postal Zip Van front sliding door glass **\$115.25 ea.**

FRONT DOOR VENT WINDOW GLASS (Glass Only)

- 297680** Clear. 1953-55 2 & 4-door sedan & station wagon without wraparound windshield. Limited availability..... **\$40.00 ea.**
- 310709** Tinted. 1955-58 sedan & station wagon with wraparound windshield. Limited availability..... **\$40.00 ea.**
- 1331204** 1959-62 convertible. Clear..... **\$40.00 ea.**
- 1350561** Left front, clear. 1963-89 Avanti..... **\$160.00 ea.**
- 1350562** Right front, tinted. 1963-89 Avanti..... **\$175.00 ea.**
- 1350563** Left front, tinted. 1963-89 Avanti..... **\$175.00 ea.**
- 1351654** Clear. 1963-66 station wagon & 1963 2 & 4-door sedan..... **\$32.50 ea.**
- 1351655** Tinted. 1963-66 station wagon & 1963 2 & 4-door sedan..... **\$32.50 ea.**
- 1351680** Clear. 1963-64 convertible, 1963 Daytona hardtop..... **\$40.00 ea.**
- 1356884** Clear. 1964-66 2 & 4-door sedan..... **\$40.00 ea.**
- 1356909** Tinted. 1964 Daytona hardtop, tinted..... **\$40.00 ea.**
- 1657673** Clear. Postal Zip Van..... **\$68.25 ea.**

FRONT DOOR VENT WINDOW & U-CHANNEL ASSEMBLY Complete with outer frame and all weatherseal rubber

- 310702** Right side, clear glass. 1955-62 sedan & station wagon. 1955's with curved windshield. Painted frame..... **\$224.50 ea.**
- 310703** Left side, clear glass. 1955-62 sedan & station wagon. 1955's with curved windshield. Painted frame..... **\$224.50 ea.**
- 1347000** Right side, clear glass. 1953-58 K-body & 1962-64 G.T Hawk ... **\$295.00 ea.**
- 1353330** Right side, clear glass. 1963 sedan & 1963-66 station wagons..... **\$195.00 ea.**
- 1353331** Left side, clear glass. 1963 sedan & 1963-66 station wagons..... **\$195.00 ea.**
- 1356900** Right side clear glass. 1964 Daytona hardtop..... **\$365.00 ea.**
- 1356901** Left side, clear glass. 1964 Daytona hardtop..... **\$365.00 ea.**

FRONT DOOR VENT WINDOW Includes Glass, Upper Pivot, When Applicable, Lower Pivots & Locking Handle

- 298912X1** Right side, clear glass. 1953-55 sedan & station wagon. 1955's without wraparound windshield. Painted frame .. **\$95.00 ea.**
- 298912X2** Right side, glass. 1953-55 sedan & station wagon. 1955's without wraparound windshield. Chrome frame..... **\$115.00 ea.**
- 298913X1** Left side, clear glass. 1953-55 sedan & station wagons. 1955's without wraparound windshield. Painted frame **\$95.00 ea.**
- 298913X2** Left side, clear glass. 1953-5 sedan & station wagon. 1955's without wraparound windshield. Chrome frame..... **\$115.00 ea.**
- 298915X1** Left side, tinted glass. 1953-55 sedan & station wagon without wraparound windshield. Black painted frame..... **\$95.00 ea.**
- 303370X1** Right side, clear glass. 1953-61 coupe. Painted frame..... **\$160.00 ea.**
- 303372X1** Right side, tinted glass. 1953-61 coupe. Painted frame. Limited availability..... **\$175.00 ea.**
- 310704X1** Right side, clear glass. 1955-62 sedan & station wagon, 1960-64 T-cab truck. Painted frame..... **\$95.00 ea.**
- 310705X1** Left side, clear glass. 1955-62 sedan & station wagon, 1960-64 T-cab truck. Painted frame..... **\$95.00 ea.**
- 310707X1** Left side, tinted glass. 1955-62 sedan & station wagon, 1960-64 T-cab truck. Painted frame..... **\$105.00 ea.**
- 1332400** Right side, clear glass. 1959-62 convertible & hardtop..... **\$140.00 ea.**
- 1332401** Left side, clear glass. 1959-62 convertible & hardtop..... **\$140.00 ea.**
- 1352655** Left side, clear glass. 1963 Daytona hardtop & 1963-64 convertible..... **\$140.00 ea.**
- 1353334** Right side, clear glass. 1963 2 & 4-door sedan & 1963-66 station wagon..... **\$95.00 ea.**
- 1353335** Left side, clear glass. 1963 2 & 4-door sedan & 1963-66 station wagon..... **\$95.00 ea.**
- 1353336** Right side, tinted glass. 1963 2 & 4-door sedan & 1963-66 station wagon..... **\$95.00 ea.**
- 1356880** Right side, clear glass. 1964-66 2 door & 4 door sedan..... **\$95.00 ea.**
- 1356904** Right side, clear glass. 1964 Daytona hardtop. Limited availability..... **\$140.00 ea.**

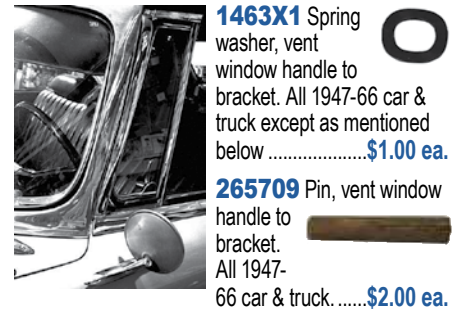

1463X1 Spring washer, vent window handle to bracket. All 1947-66 car & truck except as mentioned below..... **\$1.00 ea.**

265709 Pin, vent window handle to bracket. All 1947-66 car & truck..... **\$2.00 ea.**

265879W Rivet, top upper pivot bracket to top lower pivot bracket. All 1947-58 car except K-body hardtop & Haw..... **\$2.00 ea.**

268428 Screw, rear door vent window upper pivot. 1947-58 Land Cruiser & long wheelbase sedan..... **\$4.50 ea.**

Bracket for upper vent window pivot. All 1947-52 car except convertible & hardtop. Also fits 1949-64 C-cab truck.

268487 Right..... **\$12.00 ea.**

268488 Left..... **\$12.00 ea.**

Vent window handle & bracket. 1941-64 M-series & C-cab truck.

281910 Right..... **\$75.00 ea.**

281911 Left..... **\$75.00 ea.**

Vent window lower pivot. Early 1947 car except convertible.

284596 Right..... **\$12.00 ea.**

284597 Left..... **\$12.00 ea.**

Right rear door vent window lower pivot. 1947-52 Land Cruiser:

286291 Right.... **\$10.90 ea.**

286292 Left..... **\$10.90 ea.**

Handle. 1947-48 sedan, 1947-49 Convertible & all 1941-64 truck.

287974W Right..... **\$35.00 ea.**

287975W Left..... **\$35.00 ea.**

288584 Spring, lower vent window pivot. 1947-52 car..... **\$8.00 ea.**

- 288585** Nut, lower pivot 1947-52 \$1.00 ea.

288586 Washer, lower pivot 1947-52..... \$4.50 ea.
288588 Left front vent window lower pivot. Late 1947 thru 1952 closed cars.....\$12.00 ea.

Vent window handle, rear door on 1949-52 Land Cruiser or right front on 1949-52 convertible & Hawk & coupe 1953-64.



- 290296W** Right \$25.00 ea.
290297W Left..... \$25.00 ea.

290356 Handle. Vent window bracket & shaft. 1949-52 closed cars..... \$9.50 ea.

290661W Left upper pivot lower chrome bracket. Goes on window frame. Late 1949-52 convertible..... \$19.00 ea.

290662W Bracket, right vent window. Upper. Goes on outer frame. 1949-52 convertible & hardtop. Chrome..... \$19.00 ea.

Vent window lower pivot. 1951-52 convertible and hardtop. Also 1953-64 K - hardtop.



- 290688** Right \$26.50 ea.
290689 Left..... \$26.50 ea.

295796 Lower plastic pivot (without metal retainer) 1953-1964 K & J body hardtops..... \$12.00 ea.

298582 Rear vent window lower pivot, right or left. 1953-58 long wheelbase sedan & 1961 Cruiser \$12.50 ea.

Chrome bracket for pivot on upper vent window frame, right side on 1953-61 C-body coupe



- 298908W** Right..... \$13.25 ea.
298909W Left..... \$13.25 ea.

Vent window upper pivot. 1953-55 sedan without wraparound windshield & 1953-61 C-body coupe

- 298910** Right..... \$9.00 ea.
298911 Left..... \$9.00 ea.

Vent window lower pivot. 1953-55 sedan without wraparound windshield.

- 298920** Right .. \$12.00 ea.
298921 Left \$12.00 ea.

Vent window handle & bracket. 1953-61 coupe. Also used on rear door, vent window on 1961-62 Cruiser.



- 298922X2** Right..... \$60.00 ea.
298923X2 Left \$60.00 ea.

Vent window lower pivot. 1953-61 C-body coupe.

- 303366** Right..... \$12.00 ea.
303367 Left \$12.00 ea.

Upper door, upper pivots. 1953-64 K-body hardtop and Hawk. Used on outer vent window frame.

- 304000W** Right..... \$22.50 ea.
304001W Left \$22.50 ea.

VENT WINDOW HARDWARE

Upper bracket, vent window. 1953-64 K-body On vent window outer frame. Chrome.

- 304002W** Right..... \$22.50 ea.
304003W Left \$27.00 ea.
304294 Upper pivot screw. 1953-64 K-body, right or left. Used to install vent window frame. .. \$8.50 ea.

Vent window lower pivot. 1955-62 sedan & wagon. 1955 with wraparound windshield.

- 310718** Right..... \$12.50 ea.
310719 Left \$12.00 ea.

Upper pivot bracket, front vent window. 1955-62 sedan & wagon. 1955 with wrap around windshield.

- 310720W** Right..... \$14.50 ea.
310721W Left..... \$14.50 ea.

Upper pivot, vent window. 1955-62 sedan & wagon. 1955 with wrap-around windshield.

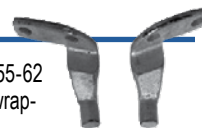

- 310740** Right \$8.50 ea.
310741 Left..... \$8.50 ea.



Vent window handle and bracket. 1958-64 hardtop & convertible, 1963-66 sedan & wagon.

- 1328470** Right..... \$42.00 ea.
1328471 Left..... \$42.00 ea.

Vent Window Hardware vent window handle. 1963-64 Avanti.

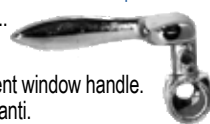

- 1328478W** Right \$32.00 ea.
1328479W Left..... \$32.00 ea.

1338866 Upper pivot screw. 1958-62 hardtop & convertible. Right or left side..... \$4.50 ea.

SLIDING REAR WINDOW KIT 1960-64 CHAMP TRUCK

All the parts necessary to convert your fixed rear window to a sliding one.

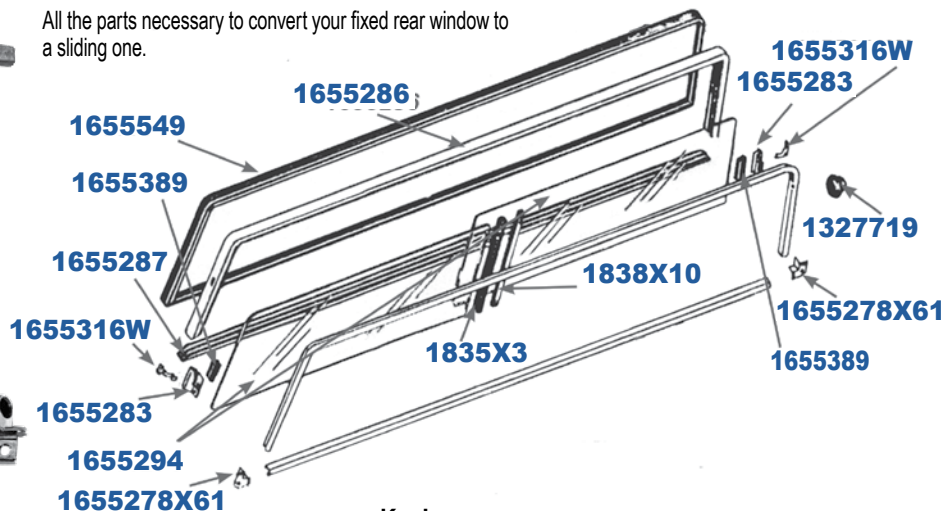

KIT INCLUDES:

- | | |
|---|--|
| 1655294 (2) Clear glass..... \$100.00 pr. | 1655283 (2) Handle \$12.00 ea. |
| 1655549 (1) Weatherseal | 1327719 (2) Bumper \$2.00 ea. |
| 1655286 (1) Run channel upper | 1655389 (2) Cushion..... \$3.00 ea. |
| 1655287 (1) Run channel lower \$190.00/ set | 1655316W (2) Catch \$10.00 ea. |
| 1838X3 (1) Chrome division channel. \$20.00 ea. | 1655278X61 (2) Corner moulding \$12.50 ea. |
| 1835X10 (1) Division seal..... \$8.00 ea. | |

Total of parts if purchased separately..... \$397.00

802297 Your Special Kit Price \$377.00 /kit

If you have questions or just need some clarification concerning what parts to order, please call our customer service department at (317) 462-3124 and someone will assist you.

REAR DOOR VENT WINDOWS, CHANNELS, & OUTER FRAME ASSEMBLIES

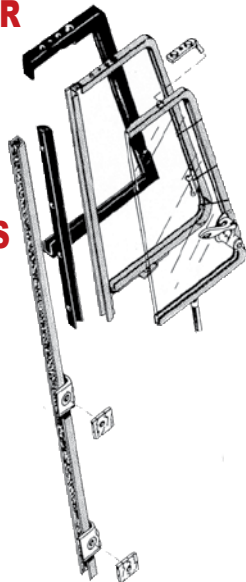

*Vent window only

- ***299182** Right rear, vent window. 1953-61 long wheelbase sedan. Clear glass **\$120.00 ea.**
- ***299183** Left rear, vent window. 1953-61 long wheelbase sedan. Clear glass **\$130.00 ea.**
- ***299184** Right rear, vent window. 1953-61 Land Cruiser, President Classic, & Cruiser. Tinted glass **\$145.00 ea.**
- ***1320701** Left rear, vent window. 1957-58 4-door station wagon. Clear glass **\$130.00 ea.**
- ***1342286** Right rear, vent window. 1962 Cruiser. Clear glass **\$130.00 ea.**
- ***1342287** Left rear, vent window. 1962 Cruiser. Clear glass **\$130.00 ea.**
- ***1342288** Left rear, vent window. 1962 Cruiser. Tinted glass **\$140.00 ea.**
- ***1351700** Right rear, vent window. 1963 Cruiser. Clear glass **\$120.00 ea.**
- ***1351701** Left rear, vent window. 1963 Cruiser. Clear glass **\$120.00 ea.**
- ***1351702** Right rear, vent window. 1963 Cruiser. Tinted glass **\$130.00 ea.**
- 1351703** Left rear, vent window assembly. Includes window, outer frame, and rubber. 1963 Cruiser. Tinted glass **\$260.00 ea.**
- 1351791** Left rear, outer frame & channel only, glass not included. 1963 Cruiser **\$130.00 ea.**
- 1352640** Right rear, vent window assembly. 1963 Cruiser. Clear glass **\$140.00 ea.**
- 1352641** Left rear, vent window assembly. 1963 Cruiser. Clear glass **\$140.00 ea.**
- 1356950** Right side, ventilator and outer frame assembly. Includes window, outer frame, and rubber. 1964-66 Cruiser. Clear glass **\$265.00 ea.**
- 1356951** Left side, ventilator and outer frame assembly. Includes window, outer frame, and rubber. 1964-66 Cruiser. Clear glass **\$265.00 ea.**
- 1356953** Left side, ventilator and outer frame assembly. Includes window, outer frame, and rubber. 1964-66 Cruiser. Tinted glass **\$265.00 ea.**

REAR VENT WINDOW GLASS (Glass only)

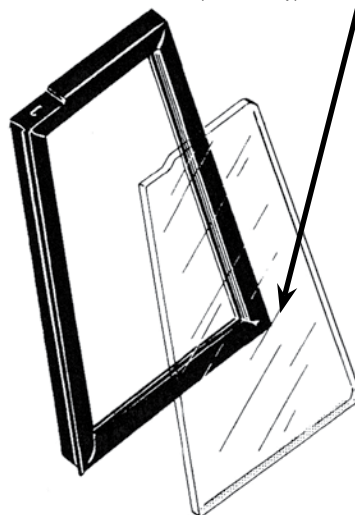

- 1339030** Clear glass. 1961 Cruiser. Limited availability **\$35.00 ea.**
- 1342298** Clear glass. 1962 Cruiser **\$35.00 ea.**
- 1343998** Clear glass. 1962 taxi. Limited availability **\$35.00 ea.**
- 1343999** Tinted glass. 1962 taxi. Limited availability **\$35.00 ea.**
- 1351710** Clear glass. 1963 Cruiser. Limited availability **\$35.00 ea.**
- 1351711** Tinted glass. 1963 Cruiser. Limited availability **\$35.00 ea.**
- 1353516** Clear glass. 1963 4-door sedan. For cars with stationary glass **\$35.00 ea.**
- 1353517** Tinted glass. 1963 4-door sedan. Limited availability **\$35.00 ea.**
- 1353518** Clear glass. 1963-66 station wagon **\$35.00 ea.**
- 1356959** Tinted glass. 1964-66 Cruiser. **\$35.00 ea.**

REAR SIDE GLASS

2-door sedan

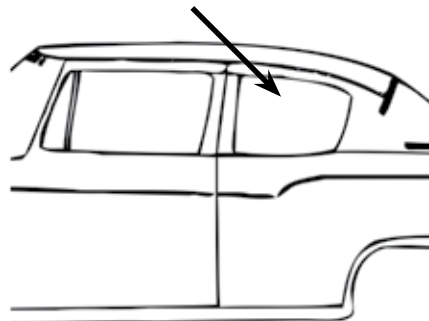

- 1331214** Clear. 1959-62 **\$45.00 ea.**
- 1331215** Tinted. 1959-62 **\$45.00 ea.**
- 1353380** Clear. 1963 **\$45.00 ea.**
- 1353381** Tinted. 1963. Limited availability **\$45.00 ea.**
- 1356649** Tinted. 1964-66 all. Limited availability .. **\$45.00 ea.**

REAR DOOR GLASS

4-door cars, glass only

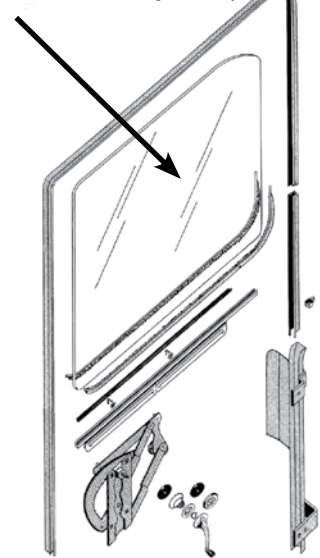

- 1320750** Clear. 1957-58 4 door station wagon. Limited availability **\$45.00 ea.**
- 1320751** Tinted. 1957-58 4 door station wagon. Limited availability **\$45.00 ea.**
- 1322506** Clear. 1959-60 4 door Lark. Limited availability **\$45.00 ea.**
- 1331212** Clear. 1959-61 long wheelbase car, 1962 Lark & Cruiser Y-8 long wheelbase **\$45.00 ea.**
- 1331213** Tinted. 1959-61 long base car, 1962 Lark & Cruiser Y-8 long wheelbase. **\$45.00 ea.**
- 1336290** Clear. 1960-62 station wagon **\$45.00 ea.**
- 1338774** Clear. 1961 Lark 4-door sedan. Limited availability **\$45.00 ea.**
- 1338775** Tinted. 1961 Lark 4-door sedan. Limited availability **\$45.00 ea.**
- ***1342452** Clear. 1962 Lark, long wheelbase **\$45.00 ea.**
- 1352636** Clear. 1963 sedan **\$45.00 ea.**
- 1352637** Tinted. 1963 sedan. (Limited availability) **\$45.00 ea.**
- 1352639** Tinted. 1963-66 station wagon **\$45.00 ea.**
- 1358212** Clear. 1964-66 4 door sedan. Limited availability **\$45.00 ea.**

* 1962 Y-4 Deluxe, Y-6 Regal
Note: Ask about any not listed.

1952 HARDTOP MOULDING

- 295945** Left rear quarter window outer moulding. Fits on driver's door next to rear quarter window. NOS **\$99.00 ea.**

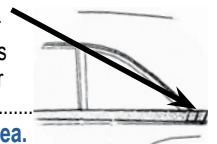

REAR QUARTER WINDOW GLASS

Hardtops, convertibles, C-body coupes & Avanti-glass only

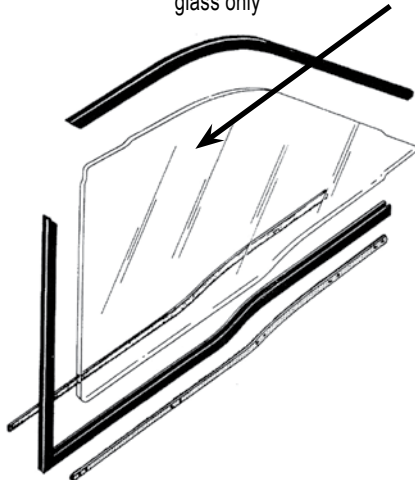

- 303047** Tinted. 1953-58 C-coupe **\$35.00 ea.**
- 1331216** Clear. 1959-61 C-body coupe **\$35.00 ea.**
- 1331217** Tinted. 1959-61 C-body coupe. Limited availability..... **\$35.00 ea.**
- 1331219** Tinted. 1959-60 J-body hardtop. Limited availability..... **\$35.00 ea.**
- 1336374** Clear. 1960-61 convertible. Limited availability..... **\$35.00 ea.**
- 1342844** Clear. 1962-63 J-body hardtop..... **\$35.00 ea.**
- 1342870** Clear. 1962-64 convertible. Limited availability..... **\$35.00 ea.**
- 1350700** Right rear, clear. 1963-89 Avanti..... **\$260.00 ea.**
- 1350702** Right rear, tinted. 1963-89 Avanti..... **\$260.00 ea.**
- 1350703** Left rear, tinted. 1963-89 Avanti..... **\$260.00 ea.**
- 1358464** Clear. 1964 Daytona hardtop. Limited availability..... **\$35.00 ea.**
- 1358465** Tinted. 1964 Daytona hardtop. Limited availability..... **\$35.00 ea.**

REAR QUARTER WINDOW & FRAME ASSEMBLIES

Hardtops, convertibles, C-body coupes & Avanti

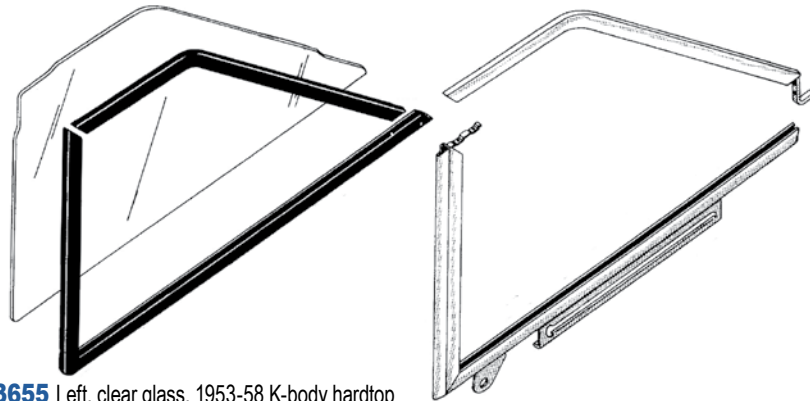

- 303655** Left, clear glass. 1953-58 K-body hardtop **\$160.00 ea.**
- 303658** Right, tinted glass. 1953-58 K-body hardtop..... **\$175.00 ea.**
- 303659** Left, tinted glass. 1953-58 K-body hardtop **\$175.00 ea.**
- 304642** Right, clear glass. 1953-61 C-body coupe. Black painted frame..... **\$160.00 ea.**
- 304643** Left, clear glass. 1953-61 C-body coupe. Black painted frame..... **\$160.00 ea.**
- 304646** Right, clear glass. 1953-61 C-body coupe. Chrome frame..... **\$175.00 ea.**
- 304647** Left, clear glass. 1953-61 C-body coupe. Chrome frame..... **\$175.00 ea.**
- 304649** Left, tinted glass. 1953-61 C-body coupe. Chrome frame..... **\$195.00 ea.**
- 1327050** Right, clear glass. 1958 J-body hardtop **\$175.00 ea.**
- 1327052** Right, tinted glass. 1958 J-body hardtop **\$195.00 ea.**
- 1327053** Left, tinted glass. 1958 J-body hardtop.. **\$195.00 ea.**
- 1332355** Left, clear glass. 1959-60 Lark hardtop . **\$175.00 ea.**
- 1332356** Right, tinted glass. 1959-60 Lark hardtop **\$195.00 ea.**
- 1336350** Right, clear glass. 1960-61 convertible.. **\$175.00 ea.**
- 1336351** Left, clear glass. 1960-61 convertible.... **\$175.00 ea.**
- 1338630** Right, clear glass. 1961 Lark hardtop..... **\$175.00 ea.**
- 1338631** Left, clear glass. 1961 Lark hardtop..... **\$175.00 ea.**
- 1338632** Right, tinted glass. 1961 Lark hardtop.... **\$195.00 ea.**
- 1338633** Left, tinted glass. 1961 Lark hardtop..... **\$195.00 ea.**
- 1342826** Right, clear glass. 1962-63 Lark & Daytona hardtop. **\$175.00 ea.**
- 1342827** Left, clear glass. 1962-63 Lark & Daytona hardtop **\$175.00 ea.**
- 1342829** Left side with tinted glass. 1962-63 Lark & Daytona hardtop. **\$195.00 ea.**
- 1342852** Right, clear glass. 1962-64 convertible.. **\$195.00 ea.**
- 1342853** Left, clear glass. 1962-64 convertible.... **\$195.00 ea.**
- 1343630** Right, clear glass. 1962-64 G.T. Hawk... **\$195.00 ea.**
- 1343631** Left, clear glass. 1962-64 G.T. Hawk..... **\$195.00 ea.**
- 1350680** Right, clear glass. 1963 Avanti..... **\$430.00 ea.**
- 1350682** Right, tinted glass. 1963 Avanti..... **\$500.00 ea.**
- 1350683** Left, tinted glass. 1963 Avanti..... **\$500.00 ea.**
- 1358450** Right, clear glass. 1964 Daytona hardtop **\$175.00 ea.**
- 1358451** Left, clear glass. 1964 Daytona hardtop **\$175.00 ea.**
- 1358452** Right, tinted glass. 1964 Daytona hardtop..... **\$195.00 ea.**
- 1358453** Left, tinted glass. 1964 Daytona hardtop. **\$195.00 ea.**
- 1358930** Right, clear glass. 1964 Avanti..... **\$430.00 ea.**

REAR QUARTER WINDOW SPRING



- 303662** Spring, rear quarter window pull-back. 1953-58 K-body hardtop. **\$12.50 ea.**

CHROME HINGE



- 1351068-9** Rear quarter window hinge. 1963-88 Avanti. Enough for one window. **\$18.00 pr.**

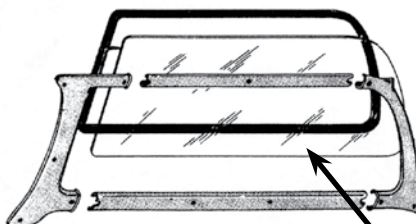

- 1322512** Rear side glass rear, right or left. 1959 all. Clear..... **\$60.00 ea.**
- 1336124** Rear side glass front. 1960-62 2-door station wagon. Clear. **\$60.00 ea.**
- 1336125** Rear side glass front. Tinted. 1960-62 2-door station wagon..... **\$60.00 ea.**

STATION WAGON REAR QUARTER GLASS - Glass only

- 1336184** Clear. 1960-62 4-door station wagon.... **\$90.00 ea.**
- 1336185** Rear side glass, tinted. 1960-62 4-door station wagon..... **\$95.00 ea.**
- 1353390** Clear. 1963-66 all..... **\$100.00 ea.**
- 1353391** Tinted. 1963-66 all..... **\$125.00 ea.**

Note: New rear quarter glass seals for station wagons.

AVANTI REAR QUARTER WINDOW PARTS

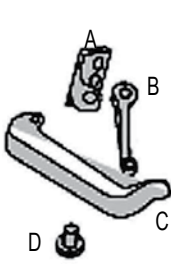

Rear quarter window parts before 1963 serial 4897.

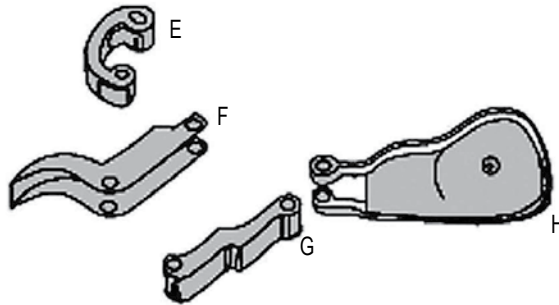

Rear quarter window parts after 1963 to 1987 serial 4897.

- | | | | |
|--|-------------|---|-------------|
| G454666 Pin, handle to link | 75¢ ea. | G454573 Pin, link to latch bracket | 75¢ ea. |
| (A) 1350464W Bracket, right latch handle. Brass | \$22.50 ea. | G9413436 Pin, handle to link | 75¢ ea. |
| (A) 1350465W Bracket, left latch handle. Brass | \$37.50 ea. | (E) 1358942W U-link, handle to frame | \$15.00 ea. |
| (B) 1350462W Link, handle to bracket | \$12.50 ea. | (F) 1358946W Handle, right latch..... | \$25.00 ea. |
| (C) 1350460W Handle, right latch..... | \$29.95 ea. | (F) 1358947W Handle, left latch..... | \$25.00 ea. |
| (C) 1350461W Handle, left latch..... | \$29.95 ea. | (G) 1358943W Link, handle to bracket..... | \$12.50 ea. |
| (D) 1350463 Screw, bracket to link | \$4.95 ea. | (H) 1358044 Escutcheon, right latch handle | \$30.00 ea. |
| | | (H) 1358045 Escutcheon, left latch handle | \$30.00 ea. |

STATION WAGON TAILGATE GLASS

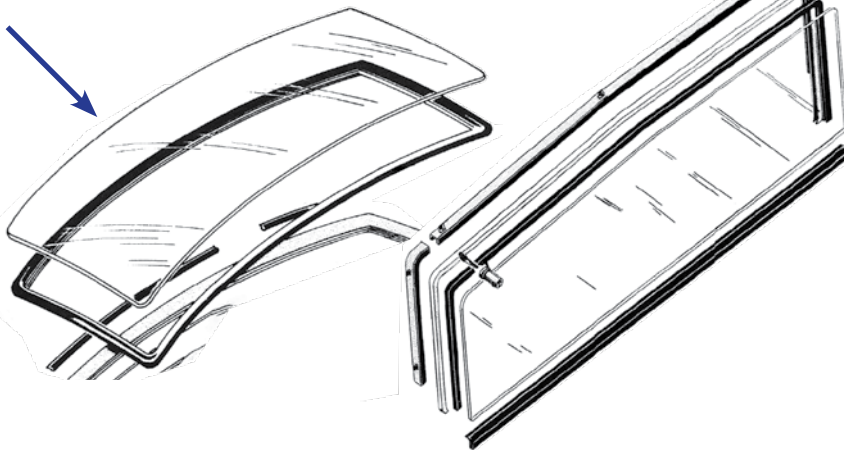

- | | | | |
|---|--------------|--|--------------|
| 305218 NOS. Clear. 1954-59 all | \$225.00 ea. | 1353346 Includes frame, clear. 1963-66 with sliding roof..... | \$375.00 ea. |
| 1336177 Tinted. 1960-61 all | \$245.00 ea. | 1353347 Includes frame, tinted. 1963-66, with sliding roof..... | \$395.00 ea. |
| 1336600 Upper tailgate assembly with clear glass & frame. 1960-61 all | \$425.00 ea. | 1355408 Clear. 1963-66, without sliding roof..... | \$235.00 ea. |
| 1336601 Upper tailgate assembly with tinted glass & frame. 1960-61 all | \$435.00 ea. | 1355409 Tinted. 1963-66, without sliding roof..... | \$245.00 ea. |
| 1343227 Tinted. 1962 | \$245.00 ea. | | |

WINDSHIELD WIPER BLADES



- 292387B** 10". 1947-52 car, all models. Truck: 1949-64 C-Cab. Original stainless type. . **\$19.95 ea.**
- 296915X2** 11". 1953-55 car, all models. Replacement non-glare..... **\$15.50 ea.**
- 296915X2B** Same as above except Original style Stainless
- 1314810B** 12". 1956-62 car all models, 1956-64 Hawk. Truck:1960-64 Champ. Original style Stainless. **\$19.95 ea.**
- 1351034X1** 15". 1963-91 Avanti. Non-glare. Metal
- 1351034B** Same as above except original stainless style
- 1657102** Zip Van

WINDSHIELD WIPER ARMS

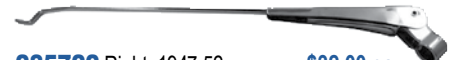

- 285722** Right. 1947-52 car..... **\$32.00 ea.**
- 285723** Left. 1947-52 car
- 292286X1** Right. 1953-1955 Cars
- 292287X1** Left. 1953-1955 Cars
- 652734** Right. 1954-64 C-cab truck
- 652735** Left. 1954-64 C-cab truck.....
- 1314802** Right. 1956-64 C & K. Includes Hawk
- 1314803** Left. 1956-64 C & K. Includes Hawk.....
- 1339050** Right. 1956-62 sedan. Includes Lark. Truck: 1960-64 Champ
- 1339051** Left. 1956-62 sedan. Includes Lark. Truck: 1960-64 Champ
- 1351033** 1963-91 Avanti. Polished Stainless.....
- 1362012** 1963-66 Lark. Brushed Stainless finish..
- 1657101** Zip Van

NOTE: We have some unidentified prewar wiper arms, please send in your old ones to match.

**Please call
(317) 462-3124
to inquire if you
need something
not listed.**

CAR BACK GLASS

Sedan & Hardtop

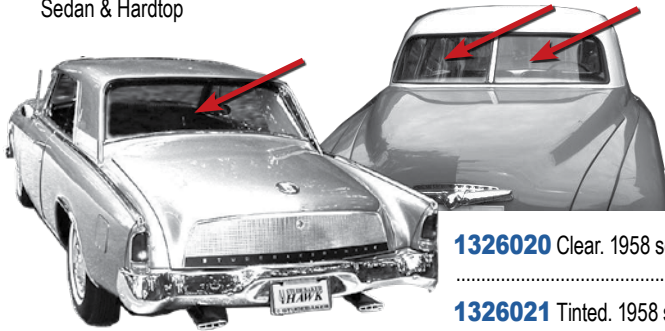

296062 Center, clear. 1952 hardtop.....**\$225.00 ea.**

296062X1 Center, tinted. 1952 hardtop.....**\$237.00 ea.**

1326020 Clear. 1958 sedan**\$350.00 ea.**

1326021 Tinted. 1958 sedan.....**\$375.00 ea.**

1338208 Clear. 1961 Lark Cruiser.....**\$350.00 ea.**

1338210 Clear. 1961 Lark except Cruiser**\$350.00 ea.**

1338211 Tinted. 1961 Lark except Cruiser**\$375.00 ea.**

1342590 Clear. 1962 Lark.....**\$350.00 ea.**

1343627 Clear. 1962-64 Hawk.....**\$350.00 ea.**

1343628 Tinted. 1962-64 Hawk.....**\$367.50 ea.**

1352320 Clear. 1963 Lark.....**\$295.00 ea.**

1352321 Tinted. 1963 Lark.....**\$315.00 ea.**

1356997 Clear. 1964-66 Lark.....**\$286.00 ea.**

1356998 Tinted. 1964-66 Lark.....**\$296.00 ea.**

284116 Right, clear. 1947-50 sedan and Land Cruiser.....**\$160.00 ea.**

284116X1 Right, tinted. 1947-50 sedan and Land Cruiser.....**\$163.30 ea.**

284117 Left, clear. 1947-50 sedan and Land Cruiser.....**\$160.00 ea.**

284117X1 Left, tinted. 1947-50 sedan and Land Cruiser.....**\$163.30 ea.**

293009 Clear. 1951-52 sedan.....**\$280.00 ea.**

293009X1 Tinted. 1951-52 sedan.....**\$295.00 ea.**

296060 Right, clear. 1952 hardtop**\$138.35 ea.**

296060X1 Right, tinted. 1952 hardtop.....**\$146.65 ea.**

296061 Left, clear. 1952 hardtop.....**\$138.35 ea.**

296061X1 Left, tinted. 1952 hardtop.....**\$146.65 ea.**

We have many windshield & back glass exterior & interior garnish mouldings. Inquire...

BACK GLASS REVEAL MOULDINGS

Stainless

1360810 Avanti upper right side moulding, after Serial #4892**\$25.00 ea.**

1360811 Avanti upper left side moulding, after Serial #4892**\$25.00 ea.**

TRUCK BACK GLASS



653702 Clear. 1955-64 C-cab**\$270.00 ea.**

653703 Tinted. 1955-64 C-cab**\$250.00 ea.**

1655290 Sliding rear glass with handle. Right, clear. 1960-64 T-cab**\$65.00 ea.**

1655291 Sliding rear glass with handle. Left, clear. 1960-64 T-cab.**\$65.00 ea.**

1655294 Sliding rear glass, clear, 1960-64 T-cab.**\$50.00 ea.**

1952 HARD-TOP BACK GLASS VERTICAL DIVIDER END CAPS

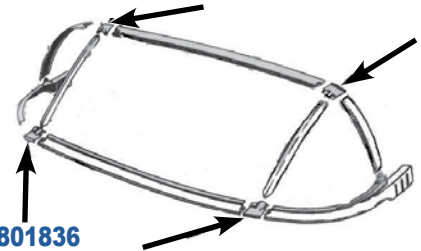

801836

Kit contains all four chrome caps at top and bottom of divider mouldings. Original NOS..... **\$75.00 set of 4**

WINDSHIELDS - TINTED OR CLEAR GLASS

284528 Clear. 1947-50 Car, all with 2-piece windshield.....**\$130.00 pr.**

284528X1 Tinted. 1947-50 Car, all with 2-piece windshield**\$135.00 pr.**

294387 Clear. 1947-52 cars all with 1-piece windshield.....**\$345.00 ea.**

296266 Tinted. 1947-52 cars all with 1-piece windshield.....**\$385.00 ea.**

297525 Clear. 1953-55 sedan & wagon with straight windshield**\$350.00 ea.**

297965 Tinted. 1953-55 sedan & wagon with straight windshield**\$355.00 ea.**

303151 Clear. All 1953-64 C & K. Includes Hawk, coupe, & hardtop..... **\$370.00 ea.**

303152 Tinted. All 1953-64 C & K. Includes Hawk, coupe, & hardtop..... **\$370.00 ea.**

308010 Clear. 1955 sedan & wagon with wrap around windshield and all 1956-58 sedan & wagon & 58 L&J bodies..... **\$443.00 ea.**

308011 Tinted. 1955 sedan & wagon with wrap around windshield and all 1956-58 sedan & wagon & 58 L&J bodies..... **\$468.00 ea.**

652078 Clear. 1949-53 2R Truck, 2-piece..... **\$130.00 pr.**

653230 Tinted. 1949-53 2R Truck, 2-piece.... **\$135.00 pr.**

653421 Clear. 1954-64 C-cab truck..... **\$322.00 ea.**

653422 Tinted. 1954-64 C-cab truck..... **\$327.00 ea.**

1331020 Clear. 1959-60 Lark. Truck: 1960-64 T-cab truck..... **\$468.00 ea.**

1331021 Tinted. 1959-60 Lark. Truck: 1960-64 T-cab truck..... **\$477.00 ea.**

1338022 Clear. 1961-62 Lark..... **\$415.00 ea.**

1338023 Tinted. 1961-62 Lark..... **\$442.00 ea.**

1351310 Tinted. 1963-89 Avanti..... **\$379.00 ea.**

1351311 Tinted with sunshade band. 1963-89 Avanti..... **\$379.00 ea.**

1352315 Clear. All 1963 Lark, 1964 convertible, & 1963-66 wagon..... **\$338.00 ea.**

1352316 Tinted. All 1963 Lark, 1964 convertible, & 1963-66 wagon..... **\$358.00 ea.**

NOTE: Please remember shipping rates will vary according to distance.

BACK GLASS MOULDING CLIPS



1350472 Moulding clip.

1963-85 Avanti**\$15.00 ea.**

1358695 Rear glass retaining clips, 1964-66 Lark. Takes 18.....**\$2.00 ea.**

AVANTI WINDSHIELD POST

Windshield post, stainless.

1350642 Right. 1963-89**\$75.00 ea.**

1350643 Left. 1963-89.....**\$75.00 ea.**



1358257 Joiner, drip rail to windshield post. 1964-66 Lark, all models except wagon..... **\$4.00 ea.**

WINDSHIELD WASHER PARTS

531892 Nozzle, 1947-55 Chrome NOS.....**\$42.00 ea.**



***FOR CORRECT CAP, STATE YEAR & MODEL OF VEHICLE**



1540398 Bag Bracket. 1956-58 sedan & 1956-64 C & K. Corrosion free stainless steel.....**\$22.00 ea.**



Note: Use With 1545092 Hanger & 1323655 Battery Bracket.



1540414 "T" fitting. 1956-61-all, 1962-64 Hawk. NOS.....**\$3.50 ea.**



1552798 Foot pump. For models with one hose outlet, including Avanti.....**\$65.00 ea.**



1558137 Foot pump, switch & cable. 1963-early '70's Avanti.....**\$90.00 ea.**

533756* Washer bag. 1953-60 all models & C & K 1961-62. Cap included.....**\$46.00 ea.**

533756X1* Washer bag. 1963-Early 70's Avanti. All models with valve screwed into cap. Cap included.....**\$46.00 ea.**

533761 Cap on water bag. For models without valve on cap.....**\$5.95 ea.**



535553 Bag Bracket. 1950-64 all models equipped with (1) 285758 or (2) 1312971P battery brackets..**\$25.00 ea.**

1540417 Nozzle. 1956 - 60 car, all models. 1961 - 64 Hawk. Truck: 1960 -64 Champ.....**\$18.50 ea.**



1545092 Hanger for washer bag. 1958 sedan & 1958-64 C & K.....**\$10.00 ea.**



Note: Use With 1323655 Battery Bracket.

1558140 Cap, on water bag. For models with valve on cap....**\$5.95 ea.**



1558968 Nozzle. 1963-66 Lark. Takes 2.....**\$15.50 ea.**



535554 Filter. Fits on bottom of pickup hose.....**\$4.50 ea.**



1552815 Valve. Fits on cap on top of washer bag. Fits some Lark 1961 and all 1962-66, 1963 -64 Hawk & Avanti ...**\$28.50 ea.**



1559267 Switch & cable assembly for electric washer. 1963-66 Lark & Hawk.....**\$35.00 ea.**



800581 Bag bracket. Replacement will work on most models.....**\$14.85 ea.**

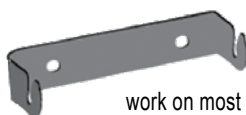

1552817 Nozzle. 1961-62 Lark. Takes 2.....**\$15.50 ea.**



1559268 Foot pump, switch & cable one hose outlet. 1963-66 Lark & 1963-64 Hawk.....**\$80.00 ea.**

WINDSHIELD WASHER HOSES



801692 Hose, 5/32".....**75¢ ft.**
801693 Hose, 1/4".....**75¢ ft.**
801786 Hose, 3/32".....**75¢ ft.**
801787 Hose, 1/8".....**75¢ ft.**
801850 Hose, 9/32".....**75¢ ft.**
802282 Hose, 7/64".....**75¢ ft.**



Restoring your car and knowing that you'll be needing lots of parts?

Perhaps, our Restorers' Package is what you need. This is how it works. **The Restorers' Package costs \$3,000.00 up front.** Then you can place large or small orders any time you want and receive a 15% discount on all parts that are not special order or rare new old stock. You can even pre-order parts for us to deliver to one of the car shows or swap meets that we attend, to save shipping charges. The only thing you can't do is use it to purchase parts at a swap meet.

186705 Crankshaft fan drive. 1936-48 Dictator & Commander & 1950 Commander. Truck: M16, 17 **\$45.00 ea.**

515113 Fan. 1942-48 Champion. Truck: M5, 15, 15A **\$24.00 ea.**

519450 Fan. 1947-48 Commander & 1950 Commander **\$30.00 ea.**

527257 Crankshaft pulley. 1951-52 Commander **\$25.00 ea.**

533890 Crankshaft fan drive. 1953-54 Commander. Truck: 2E, 7,12,13, 28, 38. 5E-8E, 7, 12, 13, 28, 40 **\$40.00 ea.**

533890 Crankshaft power steering drive. 1955-64 V-8. Truck: 3E-6E, 3, 28, 38. 7E-8E, 13, 28, 40 **\$40.00 ea.**

533892 Power steering pump. 1953-58 6-cylinder **\$20.00 ea.**

534296 Power steering pump. 1953-57 V-8 **\$51.50 ea.**



536739

Fan. 1956-64 V-8 except 1956 Golden Hawk, 1957-58 Packard & models with viscous fan. Truck: 5E-8E, 7, 12 **\$25.00 ea.**

675417 Fan. Truck: 2R - 2E 5, 10, 15, 3E, 1, 5, 10 **\$22.25 ea.**

680730 Crankshaft fan drive. Truck: 3R-E 7, 12, 13, 28, 38 **\$42.00 ea.**

1542755 Power steering pump. 1959 car. Truck: 3E-4E 13, 28, 38, 40 **\$46.00 ea.**

1546944 Fan. 1959-64 6-cylinder with heavy duty generator **\$26.80 ea.**

1546956 Crankshaft fan drive. 1959-64 6-cylinder with heavy duty generator and without air conditioning **\$46.00 ea.**

1549671 Crankshaft fan drive. 1961-64 6-cylinder with power steering and air conditioning **\$38.00 ea.**

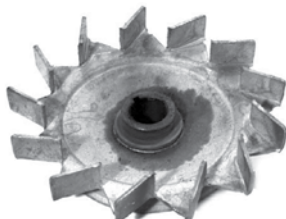

1550334 Crankshaft power steering drive. 1961-64 6-cylinder **\$20.00 ea.**

1550445 Crankshaft fan drive. 1961-64 6-cylinder with dual belt alternator **\$45.00 ea.**

1556482 Crankshaft pulley. 1963-64 Avanti. **\$195.00 ea.**

1558673 Crankshaft fan drive. 1963-64 V-8 with viscous fan **\$36.80 ea.**

1559664 Compressor & fan drive (on fan hub), 1963-64 6-cylinder **\$36.80 ea.**

1559665 Crankshaft fan drive. 1963-64 6-cylinder with viscous fan **\$48.00 ea.**

1560018 Fan. 1964 6-cylinder. Special order 1.11 to 1 fan rati **\$22.25 ea.**

1561252 Air conditioner idler pulley with bearing. 1959-60 Lark ... **\$52.00 ea.**

1563527 Power steering pump. 1965-66 V-8 **\$36.80 ea.**

1563540 Fan. 1965-66 6-cylinder **\$28.50 ea.**

1564776 Crankshaft power steering drive. 1965-66 V-8 less air conditioning **\$17.50 ea.**

1564822 Fan. 1965 V-8 without air conditioning **\$20.00 ea.**

1564823 Crankshaft fan drive. 1965-66 V-8 without air conditioning **\$18.00 ea.**

1565352 Fan drive, 1966 **\$32.50 ea.**

1565404 Crankshaft air conditioner drive. 1965-66 6-cylinder **\$54.50 ea.**

1565441 Fan drive. 1965 V-8 with air conditioning **\$24.50 ea.**

1688191 Crankshaft fan drive, export. Truck: 5E-8E 7, 12, 13, 28, 40 **\$24.50 ea.**

1692121 Crankshaft fan drive for truck with pilots. 5E 6, 11, 14, 16 **\$46.00 ea.**

1694605 Power steering pump. Truck: 7E-8E, 15, 25, 35, 45 **\$52.00 ea.**

CRANKSHAFT SPACERS

533278 Spacer, lower crankshaft pulley. 1961-64 V-8 ... **\$7.50 ea.**

534294 Spacer, lower crankshaft pulley. 1951 - 1964. 9/16", cars w/power steering **\$44.00 ea.**

1552738 Spacer, lower crankshaft pulley. 1961-64 V-8 **\$7.50 ea.**

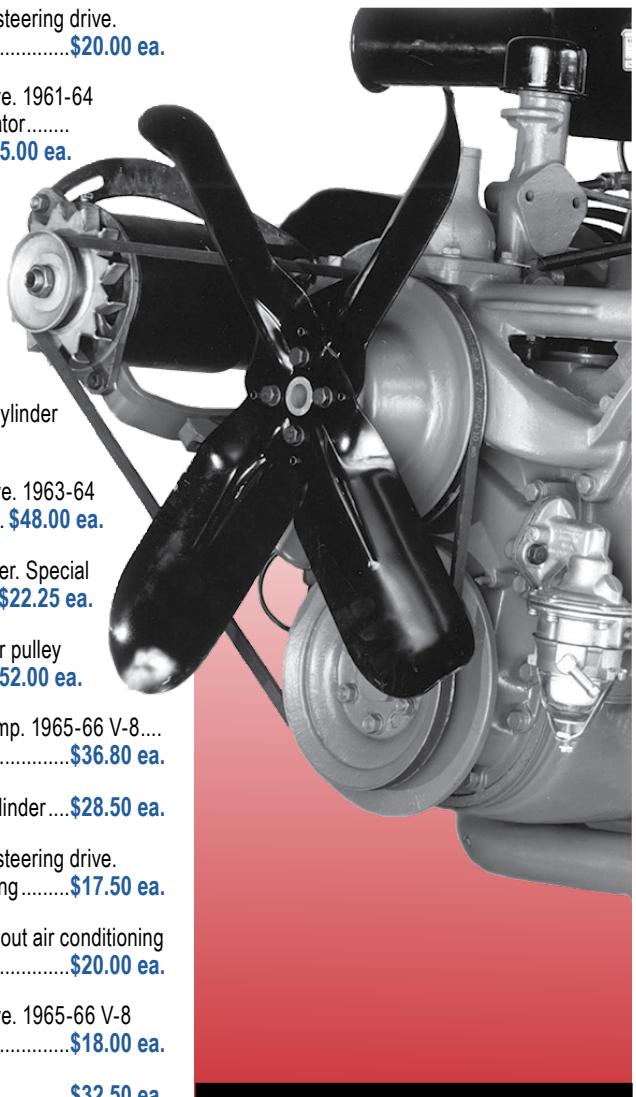

AIR CONDITIONER RELATED PULLEY PARTS

1551199 Bracket, idler pulley. 1961-64 6-cylinder **\$75.00 ea.**

1552400 Idler pulley, with bearing for air conditioner. 1961-64 all models including Avanti **\$30.00 ea.**

1552739 Bolt, lower pulley hub. 1961-64 V-8 **\$2.00 ea.**

1555981 Pulley, on fan hub. 1962 6-cylinder **\$36.80 ea.**

1565396 Bracket, idler pulley. 1965-66 6-cylinder **\$42.00 ea.**

WATER PUMP



1556483 Three groove without air conditioning. 1963-64 Avanti **\$75.00 ea.**

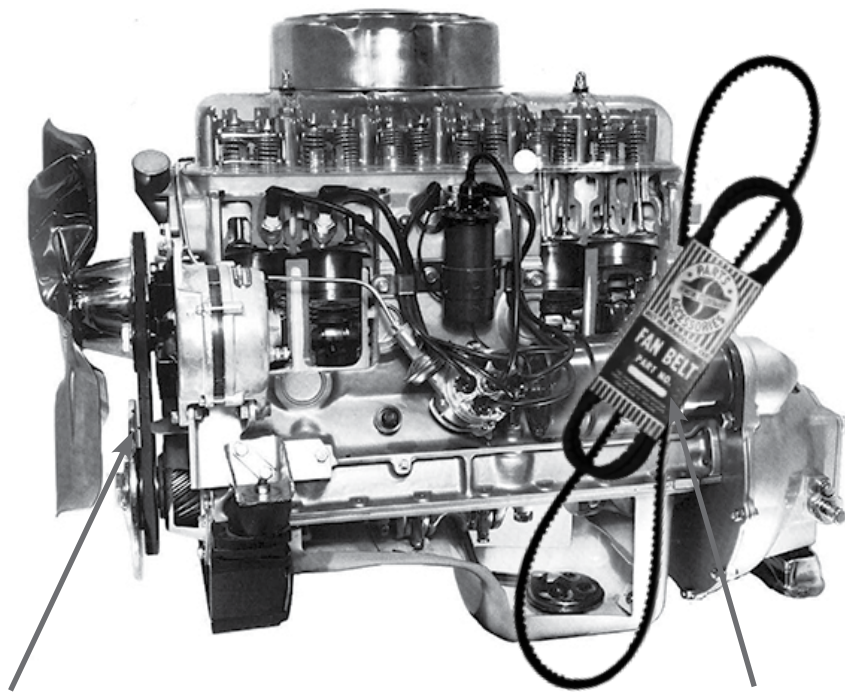

6-CYLINDER ENGINE BELTS

- 187844** 1936-42 Dictator, 1937-39 Coupe Express, 1938-42 President, Straight 8 **\$45.00 ea.**
- 196911** 1939-46 Champion. Truck: M5, M15, M15A & 2R-3E 1, 5, 10, 15..... **\$30.00 ea.**
- 518067** 1947-50 Commander **\$41.00 ea.**
- 518461** 1947-53 Champion Truck: M5, M15A **\$33.00 ea.**
- 529374** 1951-Eary 55 Truck: 7E-8E 5, 10 **\$32.00 ea.**
- 534853** 1954-63 Champion and Lark without air conditioning. Truck: 4E-8E 1,5,10 **\$22.85 ea.**
- 677266** Truck: 2R-4E 3,6,11,14,16,17 **\$35.00 ea.**
- 1548506** 1963-64 Lark with power steering and air conditioning **\$26.00 ea.**
- 1563073** 1964 without power steering and air conditioning. Truck: 8E 5,10 **\$25.00 ea.**

V-8 ENGINE BELTS

- 440448** 1956 Golden Hawk **\$28.00 ea.**
- 529374** 1951-Early 55 V-8, 1958 Packard Hawk, 1959-62 Lark V-8 w/air conditioning, 1961-62 Hawk w/air conditioning. Truck: 7E-8E 1, 5, 7, 10, 12 with air conditioning **\$32.00 ea.**
- 536762** Late 1955-58 V-8, 1957-58 Packard without A/C, 1963-64 Lark V-8 with A/C or S/C. Truck: 5E-6E 7, 12 **\$30.00 ea.**
- 684131** Truck: 3R-E: 7,12,13,28,38..... **\$27.15 ea.**
- 1546084** 1966 V-8 with 55 amp alternator..... **\$43.00 ea.**
- 1557585** 1963-64 Avanti. R-1, R-2 Avanti fan/ alternator **\$29.00 ea.**
- 1563072** 1959-64 Lark or Hawk without air conditioning. **\$27.00 ea.**
- 1565420** 1965-66 V-8 with air conditioning..... **\$29.00 ea.**
- 1685853** Truck: 2E - 4E: 7, 12, 13, 28, 38, 40 **\$29.00 ea.**
- 1694315** 1965-66 V-8 without air conditioning. **\$34.00 ea.**

SUPERCHARGER BELTS

- 1542751** 1957-58 Golden Hawk. 1957 Packard, 1958 Packard Hawk,1963-64 Lark or Hawk with jet thrust R-2 engine **\$57.00 ea.**
- 1555319** 1963-64 Avanti. Matched set of 2 belts **\$67.00 pr.**

POWER STEERING BELT

- 1548514** 1961-1964 6-cylinder car .. **\$33.00 ea.**
- 1691072** 4E-8E, 13 28 40 (w/Eaton pump)..... **\$28.00 ea.**

POWER STEERING PUMP BELTS

- 534266** 1953-58 6-cylinder **\$30.00 ea.**
- 534302** 1955-58 V-8, all models 1959 V-8 with Saginaw pump **\$28.50 ea.**
- 1540139** 1956 Golden Hawk..... **\$29.00 ea.**
- 1548509** 1960-61 V-8 Hawk **\$32.00 ea.**
- 1548513** 1959-64 V-8, all models & 1963-64 Avanti..... **\$32.00 ea.**
- 1557584** 1965-66 V-8 **\$25.00 ea.**

AIR CONDITIONING BELTS

- 1546084** 1959-64 V-8 Lark & Hawk. 1960 6-cylinder. Truck: 8E 5, 7 **\$43.00 ea.**
- 1546087** 1961-62 6-cylinder Lark **\$27.00 ea.**
- 1565406** 1965-66 all cars **\$42.00 ea.**
- 1694301** 1963-64 Avanti R-1 before #4973 **\$28.00 ea.**
- 1694306** 1964 Avanti R-1 after #4973..... **\$26.00 ea.**

Don't see what you need?

Please inquire at
(317) 462-3124



Picture: From Clarksville, Michigan, Mark Zickefoose' 1963 Avanti



PRE-WAR WINDSHIELD SEALS



- 1680X1** 1941-42 Commander & President with 1 piece windshields & with reveal moulding \$99.00 ea.
- 265488** 1937 car, all models, including Coupe Express \$99.00 ea.
- 266952** 1938-39 Commander, President & Coupe Express \$99.00 ea.
- 270965** 1939-40 Champion \$99.00 ea.
- 272358** 1940 Commander & President \$99.00 ea.
- 274191** 1941-46 Champion without reveal moulding \$99.00 ea.
- 274519** 1941-42 All models, except Champion, with 2 piece windshields and without reveal moulding \$99.00 ea.
- 276575** 1941-42 Commander & President with 2 piece windshields & reveal moulding \$99.00 ea.
- 282661** 1941-46 Champion with reveal moulding \$99.00 ea.
- 283600** 1941-42 Commander & President with 1 piece windshield & without reveal moulding \$99.00 ea.

POST-WAR WINDSHIELD SEALS

- 1680X2** 1947-52 with moulding and 1 piece windshield \$99.00 ea.



- 1763X1** 1947-52 with 1 piece windshield without moulding \$99.00 ea.
- 1942X1** 1953-54 sedan & 1955 sedan with straight windshield only \$99.00 ea.
- 1942X1** 1953-64 C & K bodies including Hawk \$99.00 ea.
- 1942X2** 1955-60 sedan, including 1955 with curved windshield. Truck: 1960-64 Champ \$99.00 ea.
- 284500** 1947-50 with 2 piece windshields & no moulding \$99.00 ea.
- 284869** 1947-50 with 2 piece windshields with moulding \$99.00 ea.
- 648736** 1941-48 M-series truck \$99.00 ea.
- 652100** 1949-53 C-cab truck with 2 piece windshields \$99.00 ea.
- 653462** 1954-64 C-cab truck \$99.00 ea.
- 1343119** 1961-62 Lark \$160.00 ea.
- 1350769** 1963-89 Avanti \$160.00 ea.
- 1358964-5** Rear quarter window seals \$150.00 pr.
- 1353355** 1963 Lark, all models, 1964 convertible and 1963-66 station wagon \$160.00 ea.
- 1356991** 1964-66 2 & 4-Door sedan, 1964 hardtop \$160.00 ea.

* Requires gluing ends.

PRE-WAR GLASS SEALS

- 1112XB** 1937 car, all models except coupe \$65.00 ea.
- 1590X1** 1939-40 Champion without reveal moulding \$99.00 ea.
- 1590X2** 1941-46 Champion without reveal moulding \$99.00 ea.
- 1590X3** 1941-42 Commander without reveal moulding \$99.00 ea.
- 1654X1** 1941-42 Commander & President with reveal moulding \$99.00 ea.
- 1654X2** 1942-46 Champion with reveal moulding.. \$99.00 ea.
- 265325** 1937 Business coupe \$80.00 ea.
- 266907** 1938-39 Commander & President \$140.00 ea.
- 272359** 1940 Commander & President \$99.00 ea.
- 801344** Most 1929-36 car. 1929 GJ, 1929-30 GL, FD, FE, FH, 1930 (53), 1930-31 (70), 1931 (90 except Q), 1930 F, 1932 (55) 1933 (56), 1932 (62) (71), 1933 (73, 82, 91, 92), 1934 A, 1935 (1A, 2A) 1934 B, C, 1935 (1B, 1C) 1936 3A, 4A \$9.00 ft.

POST-WAR REAR GLASS SEALS

- 1590X1** 1941-48 M-series trucks \$99.00 ea.
- 1590X4** 1949-54 C-cab truck * Requires gluing ends. \$99.00 ea.
- 2009X1** 1954-59 station wagon \$130.00 ea.
- 2030X1** 1955-64 C-cab truck \$99.00 ea.
- 2035X1** 1953-58 sedan 1953-61 C & K body including Hawk \$99.00 ea.
- 2035X4** 1959-60 Lark \$99.00 ea.
- 3167X1** 1962 Lark \$99.00 ea.
- 3260X1** 1963 - 1989 Avanti \$120.00 ea.
- 284501** 1947-50 2 & 4-door with 2 piece rear glass without reveal moulding \$170.00 pr.
- 284502** 1947-50 2 & 4-door with 2 piece rear glass with reveal moulding \$170.00 pr.
- 285636** 1947-51 Business coupe w/2 piece rear glass & without reveal moulding \$170.00 pr.
- 285637** 1947-52 Business coupe with 2 pc. rear glass with reveal moulding \$170.00 pr.
- 293026** 1951-52 & 4-door with 1 piece rear glass without reveal moulding \$99.00 ea.
- 293027** 1951-52 & 4-door with 1 piece reveal moulding \$99.00 ea.
- *770012** 1961 Lark \$70.00 ea.
- *770013X9** 1952 2-door hardtop \$150.00 ea.
- 800800** 1947-52 Starlight coupe complete kit, 4-pieces \$325.00/kit
- 1327397** 1958 hardtop except Hawk \$130.00 ea.
- 1343726** 1962-64 Hawk \$110.00 ea.
- 1353365** 1963 Lark \$160.00 ea.
- 1358001** 1964-66 Lark \$130.00 ea.
- 1358497** 1964 Challenger \$130.00 ea.
- 1655314** 1960-64 Champ truck with stationary rear glass \$105.00 ea.
- 1655549** 1960-64 Champ truck with sliding glass. \$120.00 ea.
- 1655549X1** 1960-64 Champ truck. Rear glass seal kit for models w/sliding glass. Includes rubber & channel. 3-pc. \$260.00/kit



INSTRUCTIONS for Installing Rubber
Use the following instructions as a guide to install rubber in your Studebaker.

APPLICATION

Upper door seal. 1947-62 sedan, including Larks. 1953-61 C-body coupe, including Hawks.

HOW TO INSTALL:

- 1).  Surface A. is glued to body or door with opening B. pointing away from door or body

APPLICATION

Lower door seal, 1947-66 all model car except Avanti.

HOW TO INSTALL:

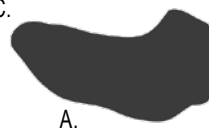
- 2).  Surface A. is on the bottom and C. points away from the car. A. & B. are glued to the body

APPLICATION

Avanti around door seal.

HOW TO INSTALL:

- 3).  Surface A. is on the bottom and C. points away from the door. A. & B. are glued to the door.

APPLICATION

Trunk seal 1936-55 sedan and 1953-64 C & K including Hawk.

HOW TO INSTALL:

- 4).  Surface A. is on the bottom and is glued into the channel with B. pointing away from the car.

APPLICATION

Trunk seal 1956-66 sedan, including Lark & Avanti.

HOW TO INSTALL:

- 5).  Surface A. is glued to the trunk lid with opening B. pointing toward the trunk lid.



COWL SEALS

- 1284XAE47** 1937 car, all models\$16.50 ea.
- 1284XAE66** Truck: 1941-48 M-series\$16.50 ea.
- 1284XAE84** 1941-46 Champion.....\$16.50 ea.
- 1284XAE84.5** 1939-40 car, all except Champion\$16.50 ea.
- 1284XAE88** 1941-42 car, all except Champion\$16.50 ea.
- 1284XAE88.5** 1938 car, all models\$16.50 ea.
- 1284XAE94** 1939-40 Champion\$16.50 ea.
- 1294X2** 1949-64 C-cab truck\$16.50 ea.
- 298965** 1947-52 cars, all. 1953-60 sedan. Truck: 1960-64 Champ. 1953-64 C & K\$16.50 ea.
- 3139X2** 1961-66 Lark\$16.50 ea.
- 3207X2** Hood to body. 1963-89 Avanti.\$16.50 ea.

NAIL SCREWS

- 1048X4** Adheres cowl seal to body, many models\$1.50 ea.

PRE-WAR UPPER & LOWER DOOR SEALS

- 800403X11** Upper. 1941-46 car, all models\$35.00 pr.
- 801359** Upper & Lower. 1938-40 car.\$50.00 pr.
- 801360** Upper. 1937 car. Note: some 37's might require more than the 72" pair\$25.00 pr.
- 801361** Lower. 1941-46 All models... \$15.00 pr.

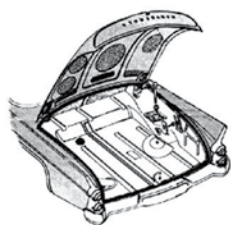

TRUNK LID SEALS

- 3177X3** Trunk rubber weatherseal. 1963-85 Avanti. \$40.00 ea.
- 800252** 1956-66 All models except C & K.

- Adheres to trunk lid.....\$40.00 ea.
- 800253** 1947-52 All models. 1953-55 sedan. Adheres to body.....\$40.00 ea.
- 801247** 1936-46 cars, all models.....\$40.00 ea.
- 1347074** 1953-64 C & K including Hawk. With spliced upper corners just like the original. Easily glues in place.....\$70.00 ea.

RUBBER ADHESIVE

- 800023** Install your new rubber with this fast-drying, strong adhesive. 5 oz. tube\$13.50 ea.

REAR QUARTER VENT WEATHERSEAL

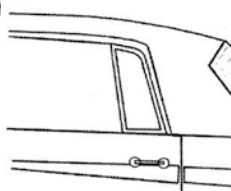

- 1592X1** 1939-40 Champion Business coupe & 1939-41 4-door Champion with stationary vent window\$110.00 pr.
- 1592X2** 1942-46 4-door Champion with stationary vent window\$110.00 pr.
- 1592X3** 1941-46 Champion Business coupe with stationary window\$110.00 pr.
- 303678-9** 1953-61 C-body coupe ..\$130.00 pr.
- 308943** Left. 1958 - 61 tax\$45.00 ea.
- 1343192-3** 1962 taxi.....\$90.00 pr.
- 1352644-5** 1963 Cruiser.....\$115.00 pr.
- 1352646-7** 1963 4-door sedan, all except Cruiser\$60.00 pr.
- 1352649** Left. 1963 - 66 station wagon\$45.00 ea.
- 1355806-7** 1964 - 66 4-door sedan all except Cruiser\$90.00 pr.
- 1356942** Right. 1964 - 66 Cruiser ...\$45.00 ea.
- 1358964-5** 1963-1983 Avanti\$150.00 pr.

REAR QUARTER WINDOW SEAL

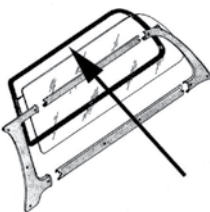

- 1320142** 1957-58 4-door wagon\$42.00 ea.
- 1337166** 1960-62 4-door wagon\$47.25 ea.

REAR QUARTER OUTER WEATHERSEAL

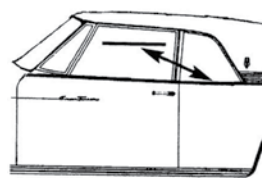

- 801100** 1962-64 GT Hawk & 1962-63 Lark hardtop. Includes clips.\$30.00 pr.
- 1358516-7** 1964 Daytona hardtop. Includes clips. NOS.. \$30.00 pr

AIR VENT SEALS

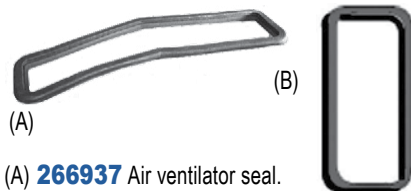

- (A) **266937** Air ventilator seal. 1936-40 Car. 1941-48 M-series truck. 1937-40 Coupe Express\$40.00 ea.
- (B) **274017** 1941-46 all models. Takes 2.....\$4.00 ea.
- (B) **284991** 1953-64 C & K including Hawk & 1947-57 sedan. Takes 2.....\$6.85 ea.
- 1338907** 1961-66 Lark. Takes 2.....\$3.50 ea.

AIR INTAKE VALVE REPAIR KITS

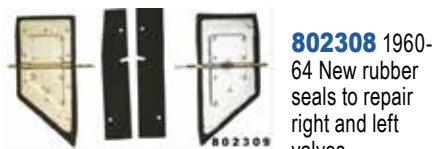

- 802308** 1960-64 New rubber seals to repair right and left valves.....\$12.00/kit
- 802309** 1960-64 New valves rubber seals and 2 access cover gaskets.....\$49.50/kit

AIR VENT SEAL KITS



- Contains enough gaskets for 1 car. Seal between body and fender. Includes lid seals.
- 800000** 1947-49 All models\$22.00/kit
- 800001** 1950-52 All models\$22.00/kit
- 800002** 1953-57 sedan & 1953-64 C & K including Hawk.....\$22.00/kit*
- 800524** 1963 Avanti. \$15.00/kit
- 800525** 1964-85 Avanti.....\$15.00/kit

WINDSHIELD CENTER BAR KITS

Each kit includes inner and outer seals and screws.

- 800032** 1941-48 M-series truck. Note: can be modified to fit some pre-war cars.....\$43.00 ea.
- 800033** 1949-64 C-cab truck.....\$43.00 ea.
- 800034** 1947-52 sedan\$43.00 ea.

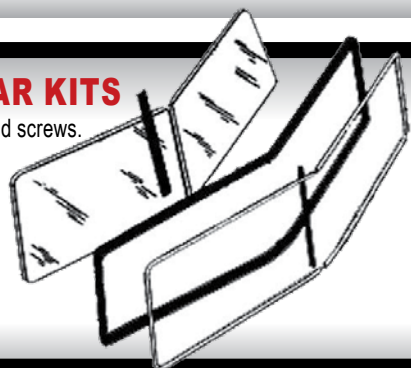

GLASS SETTING CHANNELS

Door window glass fits into this rubber.



1479 Front & rear vent window side glass. Most models 1950-70.....
.....\$1.50 ft.

1770X1 Upper door glass & sides. 1953-64 K-body hardtop including Hawk & 1947-52 convertible.....
.....\$14.00 ea.

1770X2 Rear quarter glass. 1953-58 K-body hardtop.....
.....\$14.00 ea.

1810X17 Fits bottom edge of glass, rear quarter window. 1947-52 convertible & 52 hardtop.....
.....\$10.00 ea.

1835X30 Fits bottom edge of glass. 1953-61 C-body coupe, 1947-66 2 & 4-door sedan & station wagons & 1960-64 Champ truck.....
.....\$10.00 ea.

1848X29 Fits bottom edge of door glass. 1947-52 convertible & '52 hardtop.....
.....\$12.00 ea.

1992X1 Fits bottom edge of door glass. 1953-64 K-body hardtop including Hawk 1959-64 Lark hardtop. 1960-64 convertible.....
.....\$10.50 ea.

FRONT WINDOW LINER

304181 Crimps to front edge of side glass on all 1953-64 K-body hardtop including Hawk. Fits into channel on edge of vent window allowing glass to roll up & down smoothly and stay in position rattle free.....
.....\$45.00 ea.

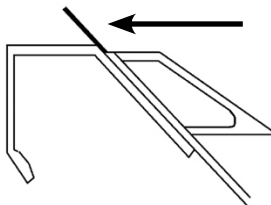

1963-66 WAGONAIRE SLIDING ROOF SEALS

1361471 Front & sides.....
.....\$65.00 ea.



1353898-9 Front corner seals.....
.....\$30.00 pr.

1351626-7 Rear corner seals.....
.....\$36.00 pr.

FENDER/BODY SHIMS

284937 Front. 1947-52, 1/8".....
.....\$12.00 ea.

285300 Rear. 1947-52, 4 door.....
.....\$6.00 ea.

291624 Front. 1947-52, 1/4".....
.....\$18.00 ea.

298340 Front. 1/8" 1953-64 C & K bodies including Hawk.....
.....\$12.00 ea.

299850 Rear. 1953-64 C & K bodies including Hawk.....
.....\$7.00 ea.

652622 Front. Truck: 1949-64 C-cab. 1/4".....
.....\$12.00 ea.

652624 Front. Truck: 1949-64 C-cab. 3/16".....
.....\$12.00 ea.

FRONT VENT WINDOW SEALS



278618-9 1941-46 all car; 1941-48 M-series truck.....
.....\$130.00 pr.

284594-5 1947-52 closed car.....
.....\$130.00 pr.

303392-3 1953-61 C-body coupe including Hawk.....
.....\$130.00 pr.

310736-7 1955 with wrap around windshield thru 1962 sedan, includes Lark.....
.....\$130.00 pr.

310736-7 1960-64 Champ truck.....
.....\$130.00 pr.

652578-9 1949-64 C-cab truck.....
.....\$130.00 pr.

1332310-1 1958 hardtop, 1959-62 hardtop & convertible.....
.....\$150.00 pr.

1347006-7 1953-64 K-body hardtop including Hawk.....
.....\$130.00 pr.

1352662-3 1963 Lark hardtop & 1963-64 convertible.....
.....\$130.00 pr.

1356924-5 1964 Lark hardtop.....
.....\$130.00 pr.

VENT WINDOW DIVISION SEALS

Rubber seal that vent window closes against.

310738 1955 (with curved windshield) to 1962. 2 & 4 door sedan. Truck: 1960-64 Champ. Rear door vent window: 1963-66 4-door.....
.....\$22.00 ea.

1320725 1958-63 hardtop (not Hawk) & convertible & 1964 convertible. Also 1964-66 2-door & 4-door sedan.....
.....\$22.00 ea.

1347005 1953-64 K-body hardtop, including Hawk.....
.....\$22.00 ea.

1356932 1964 Daytona hardtop.....
.....\$22.00 ea.

1356891 1964-66 sedan.....
.....\$22.00 ea.

"L" SHAPED LINER

Fits on forward edge of side glass and seals against front vent window glass.

800796 1939-40 Champion. 1947-52 2 & 4-door sedan, 1947-52 Land Cruiser.....
.....\$18.00 ea.

800797 1953-61 C-body coupe, including Hawk. Truck: 1949-64 C-cab. Includes rivets for installation.....
.....\$18.00 ea.

800798 1938-46 all car; & 1941-48 M-series trucks. Includes rivets for installation.....
.....\$18.00 ea.

801695 1947-48 Land Cruiser. Fits on rear glass vent window. Includes rivets for installation.....
.....\$18.00 ea.



**CALL & PLACE
YOUR ORDER TODAY!**

(317) 462-3124

VENT WINDOW STOP

304804 1953-64 K-body hardtop includes 801697. Rubber seal & chrome retainer.....
.....\$19.95 ea.

801697 1953-64 K-body hardtop. Rubber only.....
.....\$4.50 ea.

1328454 1958-64 J-body hardtop. Includes Lark, 1963-85 Avanti.....
.....\$15.00 ea.

VENT WINDOW EXTENSION SEALS

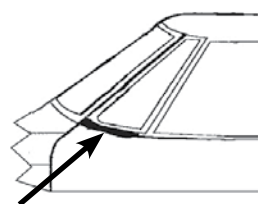

304068-9 1953-55 K-body hardtop.....
.....\$22.00 pr.

307546-7 1956-64 Hawk K-body hardtop.....
.....\$22.00 pr.

VENT WINDOW "U" CHANNEL

800806 Lower "U" channel 1947-52 2 & 4-door sedan, SLC, business coupe (closed car).....
.....\$18.00 ea.

800807 Lower "U" channel. 1953-61 C-body coupe.....
.....\$18.00 ea.

800851 1953-62 2 & 4-door sedan, includes Lark. Truck: 1960-64 Champ.....
.....\$31.25 ea.

800851X1 1963 Lark sedan, 1963-66 wagon.....
.....\$31.25 ea.

800851X2 1964-66 Lark sedan, front.....
.....\$31.25 ea.

800851X3 1953-62 Y-body, rear.....
.....\$31.25 ea.

800851X4 1963 4-dr car including station wagon, rear.....
.....\$31.25 ea.

800851X5 1964-66 4-dr car, rear.....
.....\$31.25 ea.

800852 1958-64 hardtop, except Hawk, & convertible, includes Lark.....
.....\$31.15 ea.

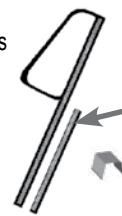

WINDOW "U" CHANNELS

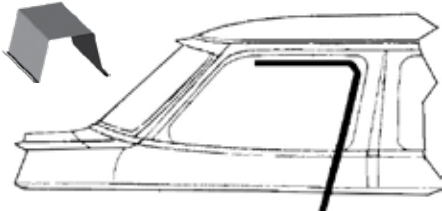

800504 U - Channel, fits around door glass on front door of late 1942 & all 1946 2-door & 4-door car. Also used on rear doors of late 1942 Land Cruiser. As well as all sedans & wagons through 1962 front doors & rear doors on all with rear door vent window. Final application, can be used on 1960-64 Champ truck. Comes in 5' lengths, enough for 1 door **\$39.75 ea.**

800504X8 U - Channel, fits around door glass on rear door of 1936-40 & late 42-46 4-door car except Land Cruiser. Fits rear quarter window on all 2 door sedan & rear door on any 4 -door car not equipped with a rear door vent window - All up to & includes 1962. Comes in 8 foot lengths. Enough for 1 door. **\$74.00 ea.**

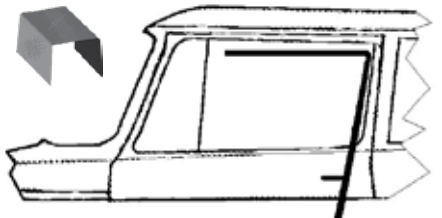

800505 Fits around front & rear door glass on 1963-66 Lark 2 & 4-door sedan & wagons. Comes in 5' length, enough for 1 door. **\$45.90 ea.***

800505X8 Rear quarter require longer 8' length. 2-dr sedan. **\$50.25 ea.***

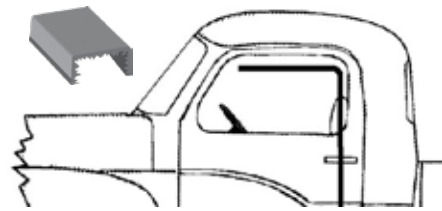

800506 Fits around door glass on M-series & C-cab truck. Comes in 5' length, enough for 1 door..... **\$25.45 ea.***

***Because Of Length, Window Runs And Channels Require Additional Shipping Charges.**

WINDOW RUN FELT STRIP

(Cat Whiskers)

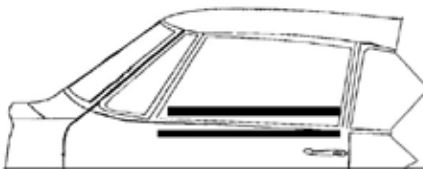

800507 1963 Avanti and most model car except 1963 - 66 Lark & most truck, use for front & rear, inner & outer windows. Comes 8 foot by 3/8" width. You can easily cut it to size..... **\$23.50 ea.**

801827 Felt window run attaches to inner door. Two 4 foot sections, enough for 2 doors. Extra wide for 1964 Avanti and later. **\$50.00 pr.**

801971 1963-66 Lark, both sedan & wagon. Comes in 8' length, 5/8" width..... **\$50.00 ea.**

Note: We Will Cut The 8 Foot Length In Half Or In Thirds At Customer Request For Easier Shipping.

Below: These window runs are pre-cut to size & ready to install.

800507X1 1941-48 M-series truck ... **\$35.00 set/4**

800507X2 1949-64 C-cab truck..... **\$45.00 set/4**

800507X3 1947-52 Starlight coupe.. **\$45.00 set/4**

800507X4 1947-52 2-door sedan..... **\$70.00 set/8**

800507X5 1947-52 4-door sedan **\$90.00 set/8**

800507X6 1953-62 2-door sedan **\$90.00 set/8**

800507X7 1953-62 4-door sedan **\$90.00 set/8**

800507X8 1954-60 2 dr. station wagon **\$45.00 set/4**

800507X9 1953-58 K-body hardtop. **\$55.00 set/8**

800507X10 1958 hardtop & 1959-62 hardtop & convertible. 1962 is 6-pieces..... **\$90.00 set/6**

800507X11 1953-61 C-body coupe. Front only, 1954-62 station wagon. 1960-64 Champ truck..... **\$45.00 set/4**

800507X12 1962-64 Hawk..... **\$55.00 set/6**

1963-66 Lark 2-door sedan. Front only .. **\$45.00 set/4**

800507X14 1963-66 Lark 4-door..... **\$90.00 set/8**

800507X15 1963-64 convertible..... **\$90.00 set/8**

800507X16 1963-64 hardtop. **\$70.00 set/6**

800507X17 1947-52 convertible..... **\$70.00 set/8**

800507X18 1947-52 Land Cruiser... **\$90.00 set/8**

1939-46 CHAMPION

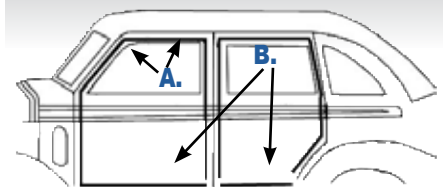

(A) **800403X11** Door seal, front or rear. 1941-46..... **\$35.00 pr.**

(B) **801361** Sill seal, front or rear. 1941-46..... **\$15.00 pr.**

(A & B) **801359** Upper & lower door. 1939-40. Takes 30 ft. per 2-door..... **\$50.00 pr.**

1284XAE94 Cowl seal, hood to body. 1939-40 **\$16.50 ea.**

1284XAE84 Cowl seal, hood to body. 1941-46 **\$16.50 ea.**

1590X1 Rear glass seal without moulding. 1939-40 **\$99.00 ea.**

1590X2 Rear glass seal without moulding. 1941-46..... **\$99.00 ea.**

1592X1 Rear quarter glass seal. Stationary. 1939-40 Business coupe **\$110.00 pr.**

1592X1 Rear quarter glass seal. 1939 41 4-Door **\$110.00 pr.**

1592X2 Rear quarter glass seal (Stationary). 1942-46 4-door..... **\$110.00 pr.**

1592X3 Rear quarter glass seal. Stationary. 1941-46 Business coupe **\$110.00 pr.**

1654X2 Rear glass seal with moulding. 1941-46 **\$99.00 ea.**

266937 Ventilator seal, on cowl. 1939-40..... **\$40.00 ea.**

270965 Windshield seal without moulding. 1939-40 **\$99.00 ea.**

272078 Gas filler grommet. 1939-4 .. **\$15.00 ea.**

274017 Air vent seal, on front fender. 1941-46. Takes 2. **\$4.00 ea.**

274191 Windshield seal without moulding. 1941-46..... **\$99.00 ea.**

274974 Hood bumpers (4). 1941-46 **85¢ ea.**

278618-9 Front vent window seal. 1941-46 **\$130.00 pr.**

282661 Windshield seal with moulding. 1942-46 **\$99.00 ea.**

800798 Vent window division seal. 1939-46. Includes rivets for installation. **\$18.00 ea.**

801247 1939-46 Trunk seal..... **\$40.00 ea.**

Please specify make and model of your car when ordering.

WINDOW RUN CLIPS

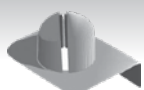

3235X1 Clip for 1963-66 Lark. sedan & wagon..... **85¢ ea.**



1624X1 All models with 1/4 inch hole **60¢ ea.**

1882X1 All models with 9/16 X 3/16 inch hole..... **75¢ ea.**



271475 "U" channel clip..... **\$3.00 ea.**

RUBBER SEALS FOR 1941-48 M-SERIES TRUCK

- (A) **800403X11** Around door seal.....\$35.00 pr.
- (B) **801412** Sill seal\$15.00 pr.
- 1284XAE66** Cowl seal\$16.50 ea.
- 1590X1** Rear glass seal.....\$99.00 ea.
- 278618-9** Front vent window seal.....\$130.00 pr.
- 648736** Windshield seal.....\$99.00 ea.
- 800032** Windshield center bar kit.....\$43.00 ea.
- 800798** Vent window division seal. Includes rivets for installation\$18.00 ea.
- 800507X1** Window run (cat whiskers).....\$35.00/set 4

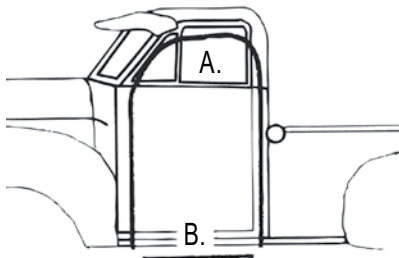

Kit contains all seals listed to the left including doors & glass.

KIT ALSO INCLUDES

- 20 **1624X1** window run clips
- 1 **266937** air ventilator seal
- 2 **271475** "U" channel clip
- 1 **272078** gas filler neck grommet
- 1 **649117** hood bumper kit
- 1 **800023** weatherstrip adhesive tube
- 2 **800506** window "U" channels

Total of all parts if Purchased separately\$667.35

Kit with windshield and back glass seals

Note: This kit includes 800032 Windshield Center Bar Kit.

800982R Special Kit Price\$600.00/kit

Kit without windshield and back glass seals. This kit does **not** include Windshield Center Bar Kit 800032.

Total of all parts if Purchased separately\$469.35

800982X1 Special Kit Price.....\$422.00/kit

NOTE : When ordering specify year and model of truck. No substitutions, deletions or returns of individual kit parts.

RUBBER SEALS FOR 1949-64 C-CAB TRUCK

- (A) **800403X11** Around door seal.....\$35.00 pr.
- (B) **800404X3** Sill seal\$15.00 pr.
- 1294X2** Cowl seal\$16.50 ea.
- 1590X4** Rear glass seal, 1949-54\$99.00 ea.
- 2030X1** Rear glass seal, 1955-64\$99.00 ea.
- 652100** Windshield seal. 1949-53. 2 piece\$99.00 ea.
- 652578-9** Front vent window seal.....\$130.00 pr.
- 653462** Windshield seal, 1954-64. 1 piece.....\$99.00 ea.
- 800507X2** Window run (cat whiskers).....\$45.00/set 4
- 800797** Vent window division seal. Includes rivets for installation\$18.00 ea.

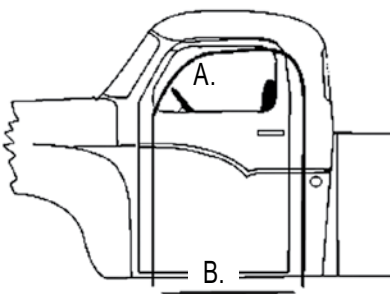

Kit contains all seals listed to the left including doors & glass.

KIT ALSO INCLUDES

- 30 **1624X1** window run clips
- 2 **271475** "U" channel clip
- 1 **272078** gas filler neck grommet
- 10 **274974** hood bumpers
- 2 **287528** hood bumpers (1949-55)
- 2 **289864** hood bumpers (1956-64)
- 1 **800023** weatherstrip adhesive tube
- 2 **800506** window "U" channels

Kit does not include 800033
See Page 60 Windshield Center bar kit.
Order separately if applicable.

Total of all parts if purchased separately\$595.90

Kit with windshield and back glass seals.

800983R Special Kit Price\$536.00/kit

Kit without windshield and back glass seals.

Total of all parts if Purchased separately\$397.90

800983X1 Special Kit Price.....\$358.00/kit

NOTE : When ordering specify year and model of truck. No substitutions, deletions or returns of individual kit parts.

RUBBER SEALS FOR 1947-EARLY 1948 CONVERTIBLE

- (A) **800400X3** Front of door seal \$10.00 pr.
- (B) **292266-7** Rear of door seal..... \$42.50 pr.
- (C) **800401X4** Sill seal..... \$18.00 pr.
- (D) **800799** Vertical seal & installation rivets for car without lower moulding \$30.00 pr.
- (E) **770151** Windshield post seal \$25.00 pr.
- (F) **770148** Seal for above door seal retainer. Enough for 1 side.....\$10.00 ea.
- (G) **770152** Windshield post moulding seal..... \$10.00 pr.
- (H) **770147** Above door seal. Takes 2..... \$25.00 ea.
- 1848X29** Lower glass setting channel front \$12.00 ea.
- 1680X2** Windshield seal \$99.00 ea.
- 1770X1** Upper glass setting rubber, door & rear quarter windows. Takes 4 \$14.00 ea.
- 1810X17** Lower glass setting channel rear. Takes 2 \$10.00 ea.
- 287334** Top header seal \$60.00 ea.

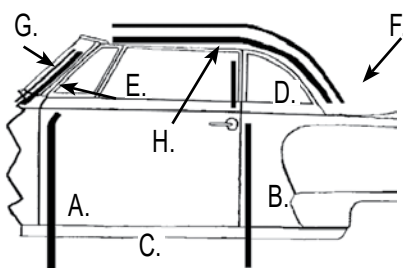

- 287427** Bumper. Top to windshield header. Takes 4. \$3.00 ea.
- 298965** Cowl seal \$16.50 ea.
- 800253** Trunk seal \$40.00 ea.
- 800507X17** Window run (cat whiskers)..... \$70.00/set 8

Note: Front Vent window seals are not available. Early 1948 convertibles have pointed vent windows and late 1948 convertibles have rounded.

Kit contains all applicable seals listed to the left including doors, glass & trunk.

KIT ALSO INCLUDES

- 50 **1624X1** window run clips
- 2 **261419** gas filler lid bumpers
- 10 **274974** hood bumpers
- 2 **284991** fresh air vent seals
- 2 **287528** hood bumpers
- 1 **800023** weatherstrip adhesive tube

Kit with windshield seal.

Total of all parts if purchased separately . \$690.70

801812

Special Kit Price\$621.00/kit

Kit without windshield seal.

Total of all parts if purchased separately ...\$591.70

801812X1

Special Kit Price\$532.00/kit

NOTE: When ordering specify year and model of car. No substitutions, deletions or returns of individual kit parts.

RUBBER SEALS FOR LATE 1948-1952 CONVERTIBLE

- (A) **800400X3** Front of door seal \$10.00 pr.
- (B) **292266-7** Rear of door seal..... \$42.50 pr.
- (C) **800401X4** Sill seal..... \$18.00 pr.
- (D) **800799** Vertical seal and installation rivets for convertible without lower moulding..... \$30.00 pr.
- (E) **770016** Windshield post seal \$25.00 pr.
- (F) **801257** Above door seal..... \$25.00 ea.
- (G) **770148** Seal for above door seal retainer. Enough for 1 side..... \$10.00 ea.
- (H) **801265** Windshield post moulding seal..... \$10.00 pr.
- 1848X29** Lower glass setting channel front..... \$12.00 ea.
- 1680X2** Windshield seal \$99.00 ea.
- 1770X1** Upper glass setting rubber, door & rear quarter windows. Takes 4 \$14.00 ea.
- 1810X17** Lower glass setting channel rear. Takes 2 \$10.00 ea.

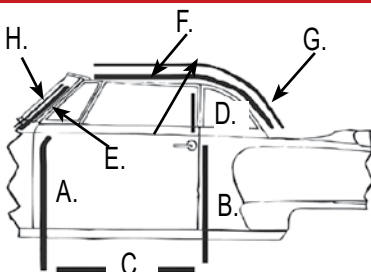

- 287334** Top header seal \$60.00 ea.
- 287427** Bumper. Top to windshield header. Takes 4 \$3.00 ea.
- 298965** Cowl seal \$16.50 ea.
- 800253** Trunk seal \$40.00 ea.
- 800507X17** Window run (cat whiskers)..... \$70.00/set 8

Note: Front Vent window seals are not available. Early 1948 convertibles have pointed vent windows and late 1948 convertibles have rounded.

Kit contains all applicable seals listed to the left including doors, glass & trunk.

KIT ALSO INCLUDES

- 50 **1624X1** window run clips
- 2 **261419** gas filler lid bumpers
- 10 **274974** hood bumpers
- 2 **284991** fresh air vent seals
- 2 **287528** hood bumpers (1948-49)
- 2 **289864** hood bumpers (1950-52)
- 1 **800023** weatherstrip adhesive tube

Kit with windshield seal.

Total of all parts if purchased separately ..\$691.20

800985R

Special Kit Price \$622.00/kit

Kit without windshield seal.

Total of all parts if purchased separately ..\$592.20

800985X1

Special Kit Price \$532.00/kit

NOTE: When ordering specify year and model of car. No substitutions, deletions or returns of individual kit parts.

RUBBER SEALS FOR 1947-52 4-DOOR SEDAN & LAND CRUISER

- (A - B) **800400X11** Around door seals, front or rear\$36.00 pr.
- (C) **800401X4** Sill seal, front or rear\$18.00 pr.
- 1624X1** Window run clips. Takes 40 60¢ ea.
- 1680X2** Windshield seal, (1 piece) for car with stainless moulding\$99.00 ea.
- 1763X1** Windshield seal, (1 piece) without stainless moulding\$99.00 ea.
- 1863X17** Lower vent "U" channel for 1947 & Early 48 sedan or Land Cruiser\$6.00 ea.
- 271475** "U" channel clip. Takes 4\$3.00 ea.
- 284500** Windshield seal. 2 pieces without stainless moulding.....\$99.00 ea.
- 284501** Rear glass seal, 1947-50 without stainless moulding. 2 piece\$170.00 ea.
- 284502** Rear glass seal. 1947-50 car with stainless moulding. 2 piece\$170.00 ea.

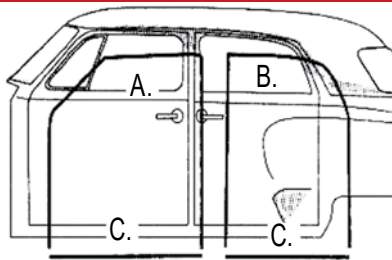

- 284594-5** Front vent window seal....\$130.00 pr.
- 284869** Windshield seal. 2 pieces for car with stainless moulding.....\$99.00 ea.
- 298965** Cowl seal\$16.50 ea.
- 293026** Rear glass seal. 1951-52. 1 piece for car without stainless moulding.....\$99.00 ea.
- 293027** Rear glass seal. 1951-52. 1 piece for cars with stainless moulding.....\$99.00 ea.

- 800253** Trunk seal\$40.00 ea.
- 800504** Front window "U" channel. Also rear on Land Cruiser\$39.75 ea.
- 800504X8** Rear window "U" channel except Land Cruiser\$74.00 ea.
- 800507X5** Window run (cat whiskers). 1947-52 4-door sedan\$90.00/set 8
- 800507X18** Window run. 1947-52 Land Cruiser\$90.00/set 8
- 800796** Front Vent window division seal\$18.00 ea.
- 800806** Lower vent "U" channels for Late 1948-52 car.....\$18.00 ea.

Note: Does not include rear vent division seals for Land Cruisers.

1947-48 Land Cruiser see page 61. Can order 801695 separately.

Kit contains all seals listed above for each model including doors, glass & trunk.

KIT ALSO INCLUDES

- 2 **261419** gas filler lid bumpers
- 10 **274974** hood bumpers
- 2 **284991** fresh air vent seals
- 2 **287528** hood bumpers (1947-49)
- 2 **289864** hood bumpers (1950-52)
- 1 **800023** weatherstrip adhesive tube

Kits do not include 800034 Windshield center bar kit. Those models requiring this seal order separately.

1947-50 4-DR. SEDAN & LAND CRUISER

Kit with windshield and back glass seals.
Total of all parts if purchased separately\$1,091.20

Special Kit Price.....\$982.00/kit
-10% quantity discount. See page 6.....\$98.20

800987R
Your Price.....\$883.80/kit

1947-50 4-DR. SEDAN & LAND CRUISER

Kit without windshield and back glass seals.
Total of all parts if purchased separately ...\$822.20

800987X1
Special Kit price.....\$739.00/kit



WWW.STUDEBAKER-INTL.COM

1951-52 4-DR. SEDAN & LAND CRUISER

Kit with windshield and back glass seals.
Total of all parts if purchased separately\$1,020.20

Special Kit Price.....\$918.00/kit
-10% quantity discount. See page 6.....\$91.80

801242R
Your Price.....\$826.20/kit

1951-52 4-DR. SEDAN & LAND CRUISER

Kit without windshield and back glass seals.
Total of all parts if purchased separately\$822.20

801242X1
Special Kit price.....\$739.00/kit

NOTE: When ordering specify year and model of car. No substitutions, deletions or returns of individual kit parts.

RUBBER SEALS FOR 1947-52 2-DOOR SEDAN

- (A) **800400X11** Around door seal \$36.00 pr.
- (B) **800401X4** Sill seal \$18.00 pr.
- 1624X1** Window run clips 60¢ ea.
- 1680X2** Windshield seal, 1 piece. 1951-52 with stainless moulding \$99.00 ea.
- 1763X1** Windshield seal, 1 piece. 1951-52 without stainless moulding \$99.00 ea.
- 1863X17** Lower vent "U" channel for 1947 & Early 1948 sedan \$6.00 ea.
- 271475** "U" channel clip. Takes 6 for 1947-Early 1948 car and 2 for all other years \$3.00 ea.
- 284500** Windshield seal. 1947-50. 2 pieces for car without stainless moulding \$99.00 ea.
- 284501** Rear glass seal, 1947-50 without stainless moulding. 2 pieces. \$170.00 ea.
- 284502** Rear glass seal, 1947-50 for car with stainless moulding. 2 pieces. \$170.00 ea.
- 284594-5** Front vent window seal.... \$130.00 pr.
- 284869** Windshield seal. 1947-50. 2 pieces for cars with stainless moulding \$99.00 ea.
- 298965** Cowl seal \$16.50 ea.

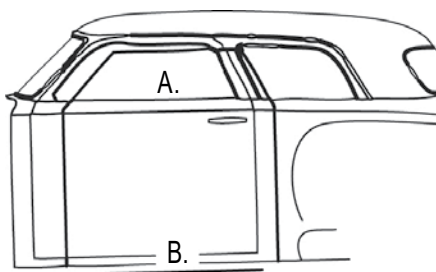

- 293026** Rear glass seal. 1951-52. 1 piece for car without stainless moulding \$99.00 ea.
- 293027** Rear glass seal. 1951-52. 1 piece for cars with stainless moulding \$99.00 ea.
- 800253** Trunk seal. \$40.00 ea.
- 800504** Window "U" channels \$39.75 ea.
- 800504X8** Window "U" channel, rear. \$74.00 ea.
- 800507X4** Window run (cat whiskers). 1947-52. \$60.00/set 8
- 800796** Vent window division seal \$18.00 ea.
- 800806** Lower vent "U" channels for Late 1948-52 car \$18.00 ea.

Kit contains all seals listed to the left including doors, glass, & cowl.

KIT ALSO INCLUDES

- 2 **261419** gas filler lid bumpers
- 10 **274974** hood bumpers
- 2 **284991** fresh air vent seals
- 2 **287528** hood bumpers (1947-49)
- 2 **289864** hood bumpers (1950-52)
- 1 **800023** weatherstrip adhesive tube

Kits do not include 800034 (Page 60)

Windshield center bar kit. Order separately for those models requiring these seals.

1947-50

Kit with windshield and back glass seals

Total of all parts if purchased separately ... \$987.20

Special Kit Price \$888.00/kit

-10% quantity discount. See page 6 \$88.80

800988R

Your Price \$799.20/kit

1947-50

Kit without windshield and back glass seals

Total of all parts if purchased separately ... \$718.20

800988X1

Special Kit price \$646.00/kit

1951-52

Kit with windshield and back glass seals

Total of all parts if purchased separately ... \$916.20

Special Kit Price \$824.00/kit

-10% quantity discount. See page 6 \$82.40

801244R

Your Price \$741.60/kit

1951-52

Kit without windshield and back glass seals

Total of all parts if purchased separately ... \$718.20

801244X1

Special Kit price \$646.00/kit

RUBBER SEALS FOR 1947-52 2-DOOR STARLIGHT COUPE

- (A) **800400X11** Around door seal \$36.00 pr.
- (B) **800401X4** Sill seal \$18.00 ea.
- 1624X1** Window run clips 60¢ ea.
- 1680X2** Windshield seal for car with stainless moulding \$99.00 ea.
- 1763X1** Windshield seal, without stainless moulding \$99.00 ea.
- 1863X17** Lower vent "U" channel for 1947 & Early 1948 \$6.00 ea.
- 271475** "U" channel clip. Takes 6 for 1947-Early 1948 car and 2 for all other years \$3.00 ea.
- 284594-5** Front vent window sea \$130.00 pr.
- 298965** Cowl seal \$16.50 ea.
- 800253** Trunk seal \$40.00 ea.
- 800504** Window "U" channel \$39.75 ea.

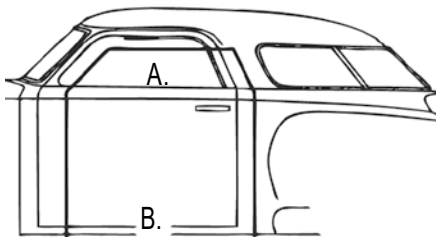

- 800507X3** Window run (cat whiskers) \$45.00/set 4
- 800796** Vent window division seal \$18.00 ea.
- 800800** Complete rear glass seal kit \$325.00/kit
- 800806** Lower vent "U" channels for Late 1948-52 car \$18.00 ea.

Kit contains all seals listed to the left including doors, glass, & cowl.

KIT ALSO INCLUDES

- 2 **261419** gas filler lid bumpers
- 10 **274974** hood bumpers
- 2 **284991** fresh air vent seals
- 2 **287528** hood bumpers (1947-49)
- 2 **289864** hood bumpers (1950-52)
- 1 **800023** weatherstrip adhesive tube

Kit with windshield and back glass seals

Total of all parts if purchased separately \$945.20

Special Kit Price \$850.00/kit

-10% quantity discount. See page 6 \$85.00

800989R **Your Price** \$765.00/kit

Kit without windshield and back glass seals

Total of all parts if purchased separately \$521.20

800989X1

Your Price \$469.00/kit

NOTE: When ordering specify year and model of car. No substitutions, deletions or returns of individual kit parts.

RUBBER SEALS FOR 1947-51 2-DOOR BUSINESS COUPE

- (A) **800400X11** Around door seal \$36.00 pr.
- (B) **800401X4** Sill seal..... \$18.00 pr.
- 1624X1** Window run clips 60¢ ea.
- 1680X2** Windshield seal. 1 piece for cars with stainless moulding \$99.00 ea.
- 1763X1** Windshield seal. 1 piece without stainless moulding..... \$99.00 ea.
- 1863X17** Lower vent "U" channel for 1947 & Early 48 \$6.00 ea.
- 271475** "U" channel clip. Takes 2 \$3.00 ea.
- 284500** Windshield seal. 2 pieces for car without stainless moulding \$99.00 ea.
- 284594-5** Front vent window seal.... \$130.00 pr.
- 284869** Windshield seal. 2 pieces for car with stainless moulding \$99.00 ea.
- 285636** Rear glass seal. 2 pieces for car without stainless moulding \$170.00 ea.
- 285637** Rear glass seal. 2 pieces for car with stainless moulding \$170.00 ea.
- 298965** Cowl seal \$16.50 ea.
- 800253** Trunk seal \$40.00 ea.

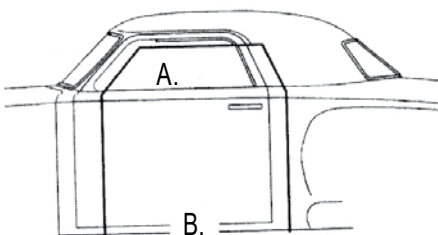

- 800504** Window "U" channels \$39.75 ea.
- 800507X3** Window run (cat whiskers)..... \$45.00/set 4
- 800796** Vent window division seal \$18.00 ea.
- 800806** Lower vent "U" channels for Late 1948-51 car \$18.00 ea.

Kit without windshield and back glass seals

Total of all parts if purchased separately ... \$515.20

- 801243X1**
- Special Kit Price \$463.00/kit**

Kit contains all seals listed to the left for each model including door, glass, trunk and cowl.

KIT ALSO INCLUDES

- 2 **261419** gas filler lid bumpers
- 10 **274974** hood bumpers
- 2 **284991** fresh air vent seals
- 2 **287528** hood bumpers (1947-49)
- 2 **289864** hood bumpers (1950-52)
- 1 **800023** weatherstrip adhesive tube

Note: Kits do not include 800034 (Page 60) Windshield center bar kit. Order separately

Kit with windshield and back glass seals.

Total of all parts if purchased separately ... \$784.20

- 801243R**
- Special Kit Price \$705.00/kit**

RUBBER SEALS FOR 1952 2-DOOR HARDTOP

- (A) **800400X3** Front of door seal. \$10.00 pr.
- (B) **292266-7** Rear of door seal..... \$42.50 pr.
- (C) **800401X4** Sill seal..... \$18.00 pr.
- (D) **800799** Vertical seal and installation rivets for car without lower moulding \$30.00 pr.
- (E) **770016** Windshield post seal \$25.00 pr.
- (F) **801257** Above door seal \$25.00 ea.
- (G) **770149** Seal for above door seal retainer. 5'. Enough for 1 side..... \$12.50 ea.
- (H) **770152** Windshield post moulding seal..... \$10.00 pr.
- 1680X2** Windshield seal \$99.00 ea.
- 1770X1** Upper glass setting rubber, door & rear quarter windows. Takes 4 \$14.00 ea.
- 1810X17** Lower glass setting channel, rear. Takes 2 \$10.00 ea.
- 1848X29** Lower glass setting channel, front. Takes 2 \$12.00 ea.
- 298965** Cowl seal \$16.50 ea.

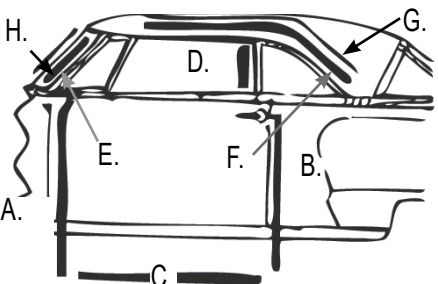

- 770011** Rear glass divider bars. Takes 4 \$10.00 ea.
- *770013X9** Rear glass seal. Corners must be mitered & glued..... \$150.00 ea.
- 800253** Trunk seal \$40.00 ea.
- 800507X17** Window run (cat whiskers) \$70.00/set 8

** Requires gluing ends.*

Note: Front Vent window seals are not available

Kit contains all seals listed to the left for each model including door, glass, trunk and cowl.

KIT ALSO INCLUDES

- 50 **1624X1** window run clips
- 2 **261419** gas filler lid bumpers
- 10 **274974** hood bumpers
- 2 **284991** fresh air vent seals
- 2 **289864** hood bumpers
- 1 **800023** weatherstrip adhesive tube

Kit with windshield seal & back glass seals.

Total of all parts if purchased separately ... \$805.70

- 800986R**
- Special Kit Price \$725.00/kit**

Kit without windshield seal & back glass seals.

Total of all parts if purchased separately ... \$556.70

- 800986RX1**
- Special Kit Price \$501.00/kit**

NOTE: When ordering specify year and model of car. No substitutions, deletions or returns of individual kit parts.

RUBBER SEALS FOR 1953-55 2-DOOR SEDAN (1955 WITH STRAIGHT WINDSHIELD ONLY)

- (A) **800400BX11** Around door seal. \$41.40 pr.
- (B) **800401X4** Sill seal. \$18.00 pr.
- 1942X1** Windshield seal. \$99.00 ea.
- 2035X1** Rear glass seal. \$99.00 ea.
- 298965** Cowl seal. \$16.50 ea.
- 800253** Trunk seal. \$40.00 ea.
- 800504** Front window "U" channel.... \$39.75 ea.
- 800504X8** Rear window "U" channel..... \$74.00 ea.
- 800507X6** Window run (cat whiskers)..... \$90.00/set 8

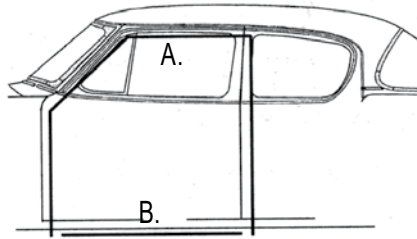

- 800851** Vent window "U" channels. \$31.25 ea.

Note: Front vent window seals are not available

Kit contains all seals listed to the left including door, glass, and cowl.

KIT ALSO INCLUDES

- 40 **1624X1** window run clips
- 2 **261419** gas filler lid bumpers
- 2 **271475** "U" channel clip
- 10 **274974** hood bumpers
- 2 **284991** fresh air vent seals
- 2 **289864** hood bumpers
- 1 **800023** weatherstrip adhesive tube

Kit with windshield and back glass seals.

Total of all parts if purchased separately\$816.20

800991R Special Kit Price \$734.00/kit

Kit without windshield and back glass seals.

Total of all parts if purchased separately\$596.20

800991X1 Special Kit Price..... \$536.00/kit

NOTE: When ordering specify year and model of car. No substitutions or deletions.

RUBBER SEALS FOR 1953-55 4-DOOR SEDAN (1955 WITH STRAIGHT WINDSHIELD ONLY)

- (A) **800400BX11** Around door seal, front \$41.40 pr.
- (B) **800400BX11** Around door seal, rear..... \$41.40 pr.
- (C) **800401X4** Sill seal, front or rear. \$18.00 pr.
- 1942X1** Windshield seal \$99.00 ea.
- 2035X1** Rear glass seal..... \$99.00 ea.
- 298965** Cowl seal. \$16.50 ea.
- 800253** Trunk seal. \$40.00 ea.
- 800504** Front window "U" channel.... \$39.75 ea.
- 800504X8** Rear window "U" channel..... \$74.00 ea.

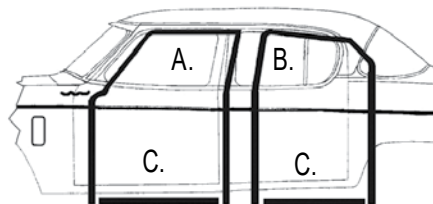

- 800507X7** Window run (cat whiskers). \$90.00/set 8
- 800851** Vent window "U" channels \$31.25 ea.

Note: Front vent window seals are not available.

Kit contains all seals listed to the left including door, glass, and trunk.

KIT ALSO INCLUDES

- 60 **1624X1** window run clips
- 2 **261419** gas filler lid bumpers
- 8 **271475** "U" channel clip
- 10 **274974** hood bumpers
- 2 **284991** fresh air vent seals
- 2 **289864** hood bumpers
- 1 **800023** weatherstrip adhesive tube

Kit with windshield and back glass seals.

Total of all parts if purchased separately ... \$985.10

Special Kit Price \$886.00/kit
-10% quantity discount. See page 6.....\$88.60

800990R
Your Price..... \$797.40/kit

Kit without windshield & back glass seals.

Total of all parts if purchased separately ... \$765.10

800990X1
Special Kit Price \$688.00/kit

NOTE: When ordering specify year, model and whether W or Y body. No substitutions, deletions or returns of individual kit parts.

RUBBER SEALS FOR 1954-55 2-DOOR STATION WAGON (1955 WITH STRAIGHT WINDSHIELD ONLY)

- (A) **800400BX11** Around door seal.....
.....\$41.40 pr.
- (B) **800401X4** Sill seal..... \$18.00 pr.
- 1942X1** Windshield seal..... \$99.00 ea.
- 2009X1** Rear glass seal..... \$130.00 ea.
- 298965** Cowl seal..... \$16.50 ea.
- 800504** Window "U" channels..... \$39.75 ea.
- 800507X19** Window run (cat whiskers).....
.....\$45.00/set 4

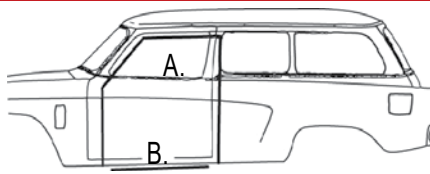

- 800851** Vent window "U" channels.....
.....\$31.25 ea.
- 802293** Tailgate, upper and sides & lower.....
.....\$15.00/kit

Kit contains all seals listed to the left including door, glass, and cowl.

KIT ALSO INCLUDES

- 30 **1624X1** window run clips
- 2 **261419** gas filler lid bumpers
- 2 **271475** "U" channel clip
- 10 **274974** hood bumpers
- 2 **284991** fresh air vent seals
- 2 **289864** hood bumpers
- 1 **800023** weatherstrip adhesive tube

Note: Most Tailgate seal and rear quarter window seals are not available.

NOTE: When ordering specify year and model of car. No substitutions, deletions or returns of individual kit parts.

Kit with windshield seal & rear glass seal.

Total of all parts if purchased separately..... \$594.20

801432R

Special Kit Price\$534.00/kit

Kit without windshield seal and rear glass seal.

Total of all parts if purchased separately..... \$354.20

801432X1

Special Kit Price\$318.00/kit

RUBBER SEALS FOR 1953-61 C-BODY COUPE

- (A) **800400X11** Around door seal, front.....
.....\$36.00 pr.
- (B) **304064** Rear quarter glass seal. Seal between glass and metal frame..... \$22.00 pr.
- (C) **303678-9** Rear quarter window seal. Thick seal surrounding window assembly.....
.....\$130.00 pr.
- (D) **800401X4** Sill seal..... \$18.00 pr.
- 1835X30** Lower glass setting channel.....
.....\$10.00 ea.
- 1942X1** Windshield seal..... \$99.00 ea.
- 2035X1** Rear glass seal..... \$99.00 ea.
- 298965** Cowl seal..... \$16.50 ea.
- 303392-3** Front vent window seal.....
.....\$130.00 pr.

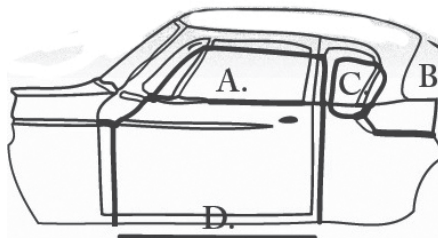

- 1347074** Trunk seal with spliced corners.....
.....\$70.00 ea.
- 800507X8** Window run (cat whiskers).....
.....\$45.00/set 4
- 800797** Vent window division seal. Includes rivets for installation..... \$18.00 ea.

KIT CONTAINS ALL SEALS LISTED TO THE LEFT FOR EACH MODEL INCLUDING DOOR, GLASS, TRUNK AND COWL.

KIT ALSO INCLUDES

- 30 **1624X1** window run clips
- 2 **261419** gas filler lid bumpers
- 2 **271475** "U" channel clip
- 5 **274974** bumper, rear gravel deflector (1953-1954)
- 12 **274974** hood bumpers
- 2 **284991** fresh air vent lid seals
- 5 **287427** bumper, rear gravel deflector (1955-1961)
- 2 **289864** hood bumpers (1953-55)
- 1 **800023** weatherstrip adhesive tube
- 2 **800504** window "U" channel
- 2 **800807** lower vent "U" channels
- 2 **1312038** hood bumpers (1956-61)

NOTE: When ordering specify year and model of car.

No substitutions, deletions or returns of individual kit parts.

Kit with windshield and back glass seal.

Total of all parts if purchased separately..... \$947.90

Special Kit Price\$853.00/kit

-10% quantity discount. See page 6.....\$85.30

800995R Your Price\$767.70/kit

Kit without windshield and back glass seal.

Total of all parts if purchased separately..... \$727.90

800995X1 Special Kit Price\$655.00/kit

RUBBER SEALS FOR 1953-58 K-BODY HARDTOP

- (A) **299824-5** Windshield post seal ... **\$24.00 pr.**
- (B) **303708-9** Vertical seal..... **\$20.00 pr.**
- (C) **303930-1** Rear of door seal..... **\$36.50 pr.**
- (D) **800401X4** Sill seal..... **\$18.00 pr.**
- (E) **303928-9** Front of door seal **\$36.50 pr.**
- (F) **1347014-5** Upper corner seal..... **\$30.00 pr.**
- (G) **770153** Under windshield post moulding seal to body. **\$10.00 pr.**
- (H) **770150** Above flipper seal to body..... **\$12.00 pr.**
- (I) **1992X1** Lower front, glass setting channel **\$10.50 ea.**
- (J) **304181** Liner, front window guide..... **\$45.00 ea.**
- 1770X1** Upper front, glass setting channel **\$14.00 ea.**
- 1770X2** Rear, glass setting channel..... **\$12.00 ea.**
- 1942X1** Windshield seal **\$99.00 ea.**
- 2035X1** Rear glass seal..... **\$99.00 ea.**

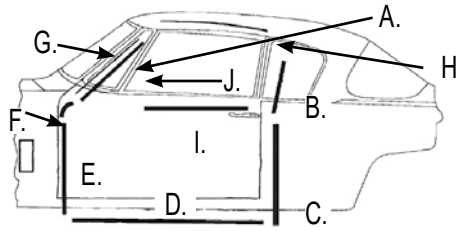

- 298965** Cowl seal **\$16.50 ea.**
- 304068-9** Front vent lower extension seal. 1953-55 **\$22.00 pr.**
- 307546-7** Front vent lower extension seal. 1956-58 **\$22.00 pr.**
- 800507X9** Window run (cat whiskers)..... **\$55.00/set 8**
- 801697** Seal, vent window stop. Takes 2 **\$4.50 ea.**
- 1347074** Trunk seal with spliced corners. **\$70.00 ea.**
- 1347005** Vent window division seal.. **\$22.00 ea.**
- 1347006-7** Front vent window seal. **\$130.00 pr.**

Kit contains all seals listed to the left for each model including doors, glass & cowl.

KIT ALSO INCLUDES MOST OF THE FOLLOWING:

- 40 **1624X1** window run clips
- 2 **261419** gas filler lid bumpers
- 12 **274974** hood bumpers
- 5 **274974** bumpers rear gravel deflector (1953-54)
- 2 **284991** fresh air vent lid seals
- 5 **287427** bumpers rear gravel deflector (1955-58)
- 2 **289864** hood bumpers (1953-55)
- 1 **800023** weatherstrip adhesive tube
- 2 **1312038** hood bumpers (1956-58)

Kit with windshield and back glass seal.

Total of all parts if purchased separately ... **\$995.10**

Special Kit Price **\$895.00/kit**
-10% quantity discount. See page 6..... **\$89.50**

800992R Your Price..... **\$805.50/kit**

Kit without windshield and back glass seal.

Total of all parts if purchased separately ... **\$775.10**

800992X1 Special Kit Price..... **\$697.00/kit**

NOTE: When ordering specify year and model of car. No substitutions, deletions or returns of individual kit parts.

RUBBER SEALS FOR 1958 2-DOOR HARDTOP

- (A) **800400X5** Front of door seal on body..... **\$16.00 pr.**
- (B) **800400X3** Rear of door seal on body **\$10.00 pr.**
- (C) **800401X4** Sill seal..... **\$18.00 pr.**
- (D) **1328454** Window stop. Takes 2..... **\$15.00 ea.**
- (E) **1331620-1** Vertical seal..... **\$20.00 pr.**
- (F) **1337344-5** Door corner seal. **\$22.00 pr.**
- 1942X2** Windshield seal **\$99.00 ea.**
- 298965** Cowl seal **\$16.50 ea.**
- 800252** Trunk seal **\$40.00 ea.**

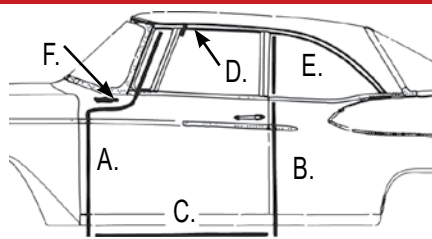

- 800507X10** Window run (cat whiskers) **\$90.00/set 6**
- 1320725** Vent window division seal..... **\$22.00 ea.**
- 1327397** Rear glass seal..... **\$130.00 ea.**
- 1332310-1** Front vent window seal..... **\$150.00 pr.**

Kit contains all seals listed to the left including door, glass, trunk and cowl.

KIT ALSO INCLUDES

- 40 **1882X1** window run clips
- 2 **261419** gas lid bumpers
- 12 **274974** hood bumpers
- 2 **289864** hood bumpers
- 1 **800023** weatherstrip adhesive tube
- 2 **800852** vent window "U" channels

NOTE: When ordering specify year and model of car. No substitutions, deletions or returns of individual kit parts.

Kit with windshield and back glass seals.

Total of all parts if purchased separately **\$819.00**

801445R Special Kit Price **\$737.00/kit**

Kit without windshield and back glass seals.

Total of all parts if purchased separately **\$579.00**

801445X1 Special Kit Price..... **\$521.00/kit**

RUBBER SEALS FOR 1955-58 2-DOOR STATION WAGON (1955 WITH WRAPAROUND WINDSHIELD ONLY)

- (A) **800400BX11** Around door seal...\$41.40 pr.
- (B) **800401X4** Sill seal\$18.00 pr.
- (C) **1337344-5** Door corner seal.....\$22.00 pr.
- 1624X1** Window run clips 60¢ ea.
- 1942X2** Windshield seal.\$99.00 ea.
- 2009X1** Rear tailgate glass seal \$130.00 ea.
- 271475** "U" channel clip. Takes 2 \$3.00 ea.
- 284991** Fresh air vent seal 1955-57 ...\$6.85 ea.
- 310736-7** Front vent window seal....\$130.00 pr.
- 310738** Vent window division seal\$22.00 ea.
- 298965** Cowl seal\$16.50 ea.

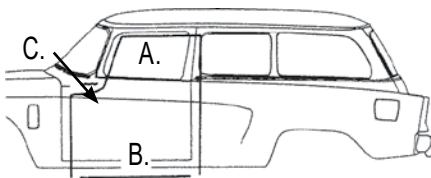

- 800504** Window "U" channel\$39.75 ea.
- 800507X19** Window run (cat whiskers).....\$45.00/set 4
- 800851** Vent window "U" channels\$31.25 ea.
- 802293** Tailgate, upper & sides & lower.....\$15.00/kit

Kit contains all seals listed to the left each model including door, glass, trunk and cowl.

KIT ALSO INCLUDES

- 2 **261419** gas filler lid bumpers
- 10 **274974** hood bumpers
- 2 **289864** hood bumpers
- 1 **800023** weatherstrip adhesive tube

NOTE: When ordering specify year and model of car. No substitutions, deletions or returns of individual kit parts.

Kit with windshield seal & rear glass seal.

- Total of all parts if purchased separately \$798.20
- 801433R Special Kit Price** **\$718.00/kit**

Kit without windshield seal and rear glass seal.

- Total of all parts if purchased separately \$558.20
- 801433X1 Special Kit Price**..... **\$502.00/kit**

RUBBER SEALS FOR 1957-58 4-DOOR STATION WAGON

- (A) **800400BX11** Around door seal, front\$41.40 pr.
- (B) **800400BX11** Around door seal, rear\$41.40 pr.
- (C) **800401X4** Sill seal, front or rear\$18.00 pr.
- (D) **1320142** Rear quarter window seal.....\$42.00 ea.
- (E) **1337344-5** Door corner seal\$22.00 pr.
- 1706X6** Rear door lower rear run. (2)\$15.00 ea.
- 1882X1** Window run clips 50¢ ea.
- 1942X2** Windshield seal\$99.00 ea.
- 2009X1** Rear glass seal.....\$130.00 ea.
- 271475** "U" channel clip. Takes 4 \$3.00 ea.
- 284991** Fresh air vent seal 1955-57\$6.85 ea.
- 298965** Cowl seal\$16.50 ea.
- 310736-7** Front vent window seal....\$130.00 pr.
- 310738** Vent window division seal\$22.00 ea.

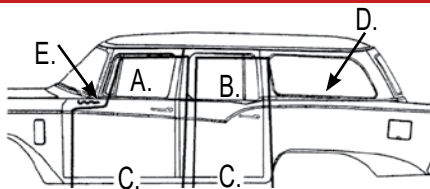

- 800504** Window "U" channel. Takes 4\$39.75 ea.
- 800507X7** Window run (cat whiskers).....\$90.00/set 8
- 800851** Vent window "U" channels\$31.25 ea.
- 802293** Tailgate, upper and sides & lower\$15.00/kit
- 1320718X** Rear door, rear window upper run with moulding (2).....\$30.00 ea.

Kit contains all seals listed to the left each model including door, glass, trunk and cowl.

KIT ALSO INCLUDES

- 2 **261419** gas filler lid bumpers
- 10 **274974** hood bumpers
- 2 **289864** hood bumpers
- 1 **800023** weatherstrip adhesive tube

NOTE: When ordering specify year and model of car. No substitutions, deletions or returns of individual kit parts.

Kit with windshield seal & rear glass seal.

- Total of all parts if purchased separately\$937.60
- Special Kit Price** **\$843.00/kit**
- 10% quantity discount. See page 6.....\$84.30
- 801434R Your Price**..... **\$758.70/kit**

Kit without windshield seal and rear glass seal.

- Total of all parts if purchased separately \$708.60
- 801434X1 Special Kit Price**..... **\$637.00/kit**

**RUBBER SEALS FOR 1955-58 2-DOOR SEDAN
(1955 WITH WRAPAROUND WINDSHIELD ONLY)**

- (A) **800400BX11** Around door seal . \$41.40 pr.
- (B) **800401X4** Sill seal \$18.00 pr.
- (C) **1337344-5** Door corner seal..... \$22.00 pr.
- 1624X1** Window run clips 60¢ ea.
- 1942X2** Windshield seal \$99.00 ea.
- 2035X1** Rear glass seal..... \$99.00 ea.
- 284991** Fresh air vent seal 1955-57 ... \$6.85 ea.
- 298965** Cowl seal \$16.50 ea.
- 310736-7** Front vent window seal... \$130.00 pr.
- 310738** Vent window division seal \$22.00 ea.
- 800252** Trunk seal. 1956-58 \$40.00 ea.
- 800253** Trunk seal. 1955..... \$40.00 ea.

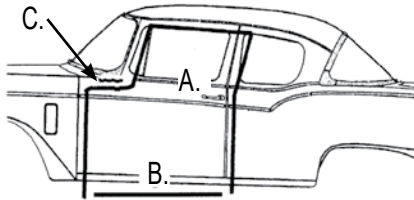

- 800504** Front window "U" channel.... \$39.75 ea.
- 800504X8** Rear window "U" channel..... \$74.00 ea.
- 800507X6** Window run (cat whiskers)..... \$90.00/set 8
- 800851** Vent window "U" channels ... \$31.25 ea.

Kit contains all seals listed to the left including door, glass, trunk and cowl.

KIT ALSO INCLUDES

- 2 **261419** gas filler lid bumpers
- 2 **271475** "U" channel clip
- 10 **274974** hood bumpers
- 2 **289864** hood bumpers
- 1 **800023** weatherstrip adhesive tube

NOTE: When ordering specify year and model of car. No substitutions, deletions or returns of individual kit parts.

Kit with windshield and back glass seals.	
Total of all parts if purchased separately	\$1,015.20
Special Kit Price	\$913.00/kit
-10% quantity discount. See page 6.....	\$91.30
800994R Your Price	\$821.70/kit
Kit without windshield and back glass seal.	
Total of all parts if purchased separately	\$806.20
800994X1 Special Kit Price	\$725.00/kit



**RUBBER SEALS FOR 1955-58 4-DOOR SEDAN
(1955 WITH WRAPAROUND WINDSHIELD ONLY)**

- (A) **800400BX11** Around door seal, front..... \$41.40 pr.
- (B) **800400BX11** Around door seal, rear..... \$41.40 pr.
- (C) **800401X4** Sill seal, front or rear \$18.00 pr.
- (D) **1337344-5** Door corner seal \$22.00 pr.
- 1624X1** Window run clips 60¢ ea.
- 1942X2** Windshield seal \$99.00 ea.
- 2035X1** Rear glass seal..... \$99.00 ea.
- 284991** Fresh air vent seal 1955-57 ... \$6.85 ea.
- 298965** Cowl seal \$16.50 ea.
- 310736-7** Front vent window seal... \$130.00 pr.
- 310738** Vent window division seal \$22.00 ea.
- 800252** Trunk seal. 1956-58 \$40.00 ea.
- 800253** Trunk seal. 1955..... \$40.00 ea.

Specify W or Y body when ordering.

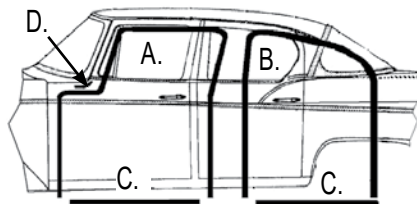

- 800504** Window "U" channel. Front .. \$39.75 ea.
- 800504X8** Rear window "U" channel..... \$74.00 ea.
- 800507X7** Window run (cat whiskers)..... \$90.00/set 8
- 800851** Vent window "U" channels ... \$31.25 ea.

Kit contains all seals listed to the left including door, glass, trunk and cowl.

KIT ALSO INCLUDES

- 2 **261419** gas filler lid bumpers
- 8 **271475** "U" channel clip
- 10 **274974** hood bumpers
- 2 **289864** hood bumpers
- 1 **800023** weatherstrip adhesive tube

Kit with windshield and back glass seals.	
Total of all parts if purchased separately	\$1,182.60
Special Kit Price	\$1,064.00/kit
-10% quantity discount. See page 6.....	\$106.40
800993R Your Price	\$957.60/kit

Kit without windshield & back glass seals.	
Total of all parts if purchased separately ...	\$973.60
Special Kit Price	\$876.00/kit
-10% quantity discount. See page 6.....	\$87.60
800993X1 Your Price	\$788.40/kit

NOTE: When ordering specify year and model of car. No substitutions, deletions or returns of individual kit parts.

RUBBER SEALS FOR 1959-60 LARK 2-DOOR SEDAN

- (A) **800400BX11** Around door seal \$41.40 pr.
- (B) **800401X4** Sill seal \$18.00 pr.
- (C) **1337344-5** Door corner seal \$22.00 pr.
- 1942X2** Windshield seal \$99.00 ea.
- 2035X4** Rear glass seal \$80.00 ea.
- 298965** Cowl seal \$16.50 ea.
- 310736-7** Front vent window seal.... \$130.00 pr.
- 310738** Vent window division seal \$22.00 ea.
- 800252** Trunk seal \$40.00 ea.

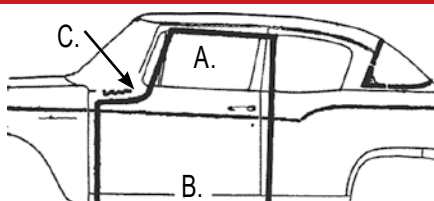

- 800504** Window "U" channel. Front .. \$39.75 ea.
- 800504X8** Window "U" channel. Rear \$74.00 ea.
- 800507X6** Window run (cat whiskers)..... \$90.00/set 8
- 800851** Vent window "U" channels \$31.25 ea.

Kit contains all seals listed to the left including door, glass, trunk and cowl.

KIT ALSO INCLUDES

- 40 **1624X1** window run clip
- 2 **261419** gas filler lid bumpers
- 2 **271475** "U" channel clip
- 1 **800023** weatherstrip adhesive tube
- 6 **1339574X1** hood bumpers
- 2 **1332093X2** hood bumpers

NOTE: When ordering specify year and model of car. No substitutions, deletions or returns of individual kit parts.

Kit with windshield and back glass seals.

Total of all parts if purchased separately	\$981.50
Special Kit Price	\$883.00 /kit
-10% quantity discount. See page 6.....	\$88.30
800997R Your Price	\$794.70/kit

Kit without windshield and back glass seals.

Total of all parts if purchased separately	\$783.50
800997X1 Special Kit Price	\$705.00/kit

RUBBER SEALS FOR 1959-60 LARK 4-DOOR SEDAN

- (A) **800400BX11** Around door seal, front \$41.40 pr.
- (B) **800400BX11** Around door seal, rear \$41.40 pr.
- (C) **800401X4** Sill seal, front or rear \$18.00 pr.
- (D) **1337344-5** Door corner seal \$22.00 pr.
- 1942X2** Windshield seal \$99.00 ea.
- 2035X4** Rear glass seal \$80.00 ea.
- 298965** Cowl seal \$16.50 ea.
- 310736-7** Front vent window seal.... \$130.00 pr.
- 310738** Vent window division seal \$22.00 ea.

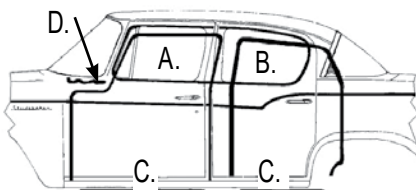

- 800252** Trunk seal \$40.00 ea.
- 800504** Front window "U" channel \$39.75 ea.
- 800504X8** Rear window "U" channel \$74.00 ea.
- 800507X7** Window run (cat whiskers)..... \$90.00/set 8
- 800851** Vent window "U" channel \$31.25 ea.

Kit contains all seals listed to the left for each model including door, glass, trunk and cowl.

KIT ALSO INCLUDES

- 40 **1624X1** window run clip
- 2 **261419** gas filler lid bumpers
- 8 **271475** "U" channel clip
- 1 **800023** weatherstrip adhesive tube
- 6 **1339574X1** hood bumpers
- 2 **1332093X2** hood bumpers

NOTE: When ordering specify year and model of car. No substitutions, deletions or returns of individual kit parts.

Kit with windshield and back glass seals.

Total of all parts if purchased separately	\$1,046.90
Special Kit Price	\$942.00 /kit
-10% quantity discount. See page 6.....	\$94.20
800996R Your Price	\$847.80/kit

Kit without windshield and back glass seals.

Total of all parts if purchased separately	\$848.90
Special Kit Price	\$764.00 /kit
-10% quantity discount. See page 6.....	\$76.40
800996X1 Your Price	\$687.60/kit

RUBBER SEALS FOR 1959-60 LARK 2-DOOR HARDTOP

- (A) **800400X5** Front of door seal on body.....\$16.00 pr.
- (B) **1331996-7** Rear of door seal on body\$86.00 pr.
- (C) **800401X4** Sill seal\$18.00 pr.
- (D) **1328454** Window stop. Takes 2.....\$15.00 ea.
- (E) **1331620-1** Vertical seal\$20.00 pr.
- (F) **1337344-5** Door corner seal\$22.00 pr.
- 1942X2** Windshield seal\$99.00 ea.
- 2035X4** Rear glass seal.....\$80.00 ea.
- 298965** Cowl seal\$16.50 ea.
- 800252** Trunk seal\$40.00 ea.

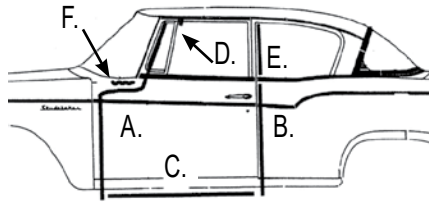

- 800507X10** Window run (cat whiskers).....\$90.00/set 6
- 1332310-1** Front vent window seal.....\$150.00 pr.
- 1320725** Vent window division seal.....\$22.00 ea.
- 1331926-7** Above door seal\$160.00 ea.

Kit contains all seals listed to the left including door, glass, & cowl.

KIT ALSO INCLUDES

- 40 **1882X1** window run clips
- 2 **261419** gas lid bumpers
- 1 **800023** weatherstrip adhesive tube
- 2 **800852** vent window "U" channels
- 6 **1339574X1** hood bumpers
- 2 **1332093X2** hood bumpers

Kit without windshield and back glass seals

- Total of all parts if purchased separately \$824.25
- 801001X1 Special Kit Price**.....\$741.00/kit

Kit with windshield and back glass seals.

- Total of all parts if purchased separately \$1,022.25

- Special Kit Price**\$920.00/kit
- 10% quantity discount. See page 6.....\$92.00

801001R

- Your Price**.....\$828.00/kit

NOTE: When ordering specify year and model of car. No substitutions, deletions or returns of individual kit parts.

RUBBER SEALS FOR 1960-62 LARK CONVERTIBLE

- (A) **800400X5** Front of door seal on body.....\$16.00 pr.
- (B) **1331996-7** Rear of door seal on body.....\$86.00 pr.
- (C) **800401X4** Sill seal\$18.00 pr.
- (D) **800362** Above door seal. 5'.....\$37.85 ea.
- (E) **1337060-1** Windshield post seal.....\$50.00 pr.
- (F) **1328454** Window stop. Takes 2.....\$15.00 ea.
- (G) **1331620-1** Vertical seal.....\$20.00 pr.
- (H) **1337344-5** Door corner seal.....\$22.00 pr.
- 1942X2** Windshield seal. 1960 only.....\$99.00 ea.
- 3112X2** Above windshield header front seal, 1960-64 convertibles.....\$22.00 ea.
- 3139X2** Cowl seal.1961-62.....\$16.50 ea.

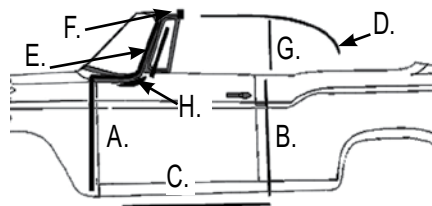

- 298965** Cowl seal. 1960\$16.50 ea.
- 800252** Trunk seal\$40.00 ea.
- 800507X10** Window run (cat whiskers).....\$90.00/set 6
- 1320725** Vent window division seal . \$22.00 ea.
- 1332310-1** Front vent window seal.....\$150.00 pr.
- 1339015** Above windshield moulded header seal. 1961-62 only\$75.00 ea.
- 1343119** Windshield seal 1961-62.....\$160.00 ea.

Kit contains all seals listed to the left including door, glass, trunk and cowl.

KIT ALSO INCLUDES

- 40 **1882X1** window run clips
- 2 **261419** gas lid bumpers (1960-61 only)
- 1 **800023** weatherstrip adhesive tube
- 2 **800852** vent window "U" channels
- 6 **1339574X1** hood bumpers
- 2 **1332093X2** hood bumpers

1960 Kit with windshield seal

- Total of all parts if purchased separately .. \$910.95

- Special Kit Price**\$819.00/kit
- 10% quantity discount. See page 6.....\$81.90

- 801002R Your Price**.....\$737.10/kit

1961-62 Kit with windshield seal

- Total of all parts if purchased separately \$1,066.95

- Special Kit Price**\$960.00/kit
- 10% quantity discount. See page 6.....\$96.00

- 801004R Your Price**.....\$864.00/kit

1961-62 Kit without windshield seal

- Total of all parts if purchased separately \$886.95

- Special Kit Price**\$798.00/kit
- 10% quantity discount. See page 6.....\$79.80

- 801004X1 Your Price**.....\$718.20/kit

1960 Kit without windshield seal

- Total of all parts if purchased separately ...\$811.95

- 801002X1 Special Kit Price**.....\$730.00/kit

RUBBER SEALS FOR 1959-60 2-DOOR STATION WAGON

- (A) **800400BX11** Around door seal.....\$41.40 pr.
- (B) **800401X4** Sill seal, front.....\$18.00 pr.
- (C) **1337344-5** Door corner seal.....\$22.00 pr.
- 1942X2** Windshield seal.....\$99.00 ea.
- 2009X1** Tailgate glass seal (1959 only).....\$130.00 ea.
- 298965** Cowl seal.....\$16.50 ea.
- 305682** Rear quarter window front run/sliding channel.....\$54.15 ea.
- 310736-7** Front vent window seal...\$130.00 pr.
- 310738** Vent window division seal...\$22.00 ea.

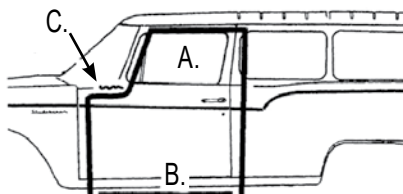

- 800504** Window "U" channel.....\$39.75 ea.
- 800507X11** Window run.....\$45.00/set 4
- 800851** Vent window "U" channels...\$31.25 ea.
- 802293** Tailgate, upper and sides & lower.....\$15.00/kit

Note: Back glass seal is not available for 1960 wagon.

Kit contains all seals listed to the left including door, glass, & cowl. Kit also includes (depending on model) most of the following.

KIT ALSO INCLUDES

- 20 **1624X1** window run clips
- 2 **271475** "U" channel clip
- 1 **305682** sliding channel
- 1 **800023** weatherstrip adhesive tube
- 6 **1339574X1** hood bumpers
- 2 **1332093X2** hood bumpers

1959 Kit with windshield and rear glass seal.

Total of all parts if purchased separately...\$855.30

Special Kit Price\$769.00/kit
-10% quantity discount. See page 6.....\$76.90

800998R Your Price.....\$692.10/kit

1960 Kit with windshield seal and back glass seal

Total of all parts if purchased separately.....\$723.80

801449R Special Kit Price\$651.00/kit

1960 Kit without windshield seal.

Total of all parts if purchased separately.....\$624.80

801449X1 Special Kit Price.....\$562.00/kit

1959 Kit with windshield seal.

Total of all parts if purchased separately...\$626.30

800998X1 Special Kit Price\$563.00/kit

RUBBER SEALS FOR 1960-62 LARK 4-DOOR STATION WAGON

- (A) **800400BX11** Around door seal, front.....\$41.40 pr.
- (B) **800400BX11** Around door seal, rear.....\$41.40 pr.
- (C) **800401X4** Sill seal, front or rear.....\$18.00 pr.
- (D) **1337166** Rear quarter window...\$47.25 ea.
- (E) **1337344-5** Door corner seal.....\$22.00 pr.
- 1942X2** Windshield seal 1960.....\$99.00 ea.
- 3139X2** Cowl seal, 1961-62.....\$16.50 ea.
- 298965** Cowl seal, 1960.....\$16.50 ea.
- 310736-7** Front vent window seal...\$130.00 pr.
- 310738** Vent window division seal...\$22.00 ea.
- 800504** Window "U" channel. Front..\$39.75 ea.

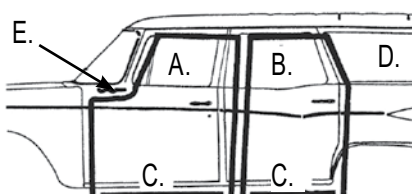

- 800504X8** Window "U" channel. Rear.....\$74.00 ea.
- 800507X7** Window run (cat whiskers).....\$90.00/set
- 800851** Vent window "U" channels...\$31.25 ea.
- 1343119** Windshield seal 1961-62..\$160.00 ea.
- 802293** Tailgate, upper and sides & lower.....\$15.00/kit

Kit contains all seals listed for each model including door, glass and cowl. Kit also includes (depending on model) most of the following.

KIT ALSO INCLUDES

- 40 **1624X1** window run clips
- 2 **261419** gas filler lid bumpers
- 4 **271475** "U" channel clip
- 1 **800023** weatherstrip adhesive tube
- 6 **1339574X1** hood bumpers
- 2 **1332093X2** hood bumpers

1960 Kit with windshield seal & rear glass seal

Total of all parts if purchased separately...\$903.90

Special Kit Price\$813.00/kit
-10% quantity discount. See pg. 6.....\$81.30

800999R Your Price.....\$731.700/kit

1961-62 Kit with windshield seal & tailgate seal kit

Total of all parts if purchased separately.....\$1,106.40

Special Kit Price\$995.00/kit
-10% quantity discount. See page 6.....\$99.50

801000R Your Price.....\$895.50/kit

1961-62 Kit without windshield seal & tailgate seal kit

Total of all parts if purchased separately..\$926.40

Special Kit Price\$833.00/kit
-10% quantity discount. See page 6.....\$83.30

801000X1 Your Price.....\$749.70/kit

1960 Kit without windshield seal & rear glass seal

Total of all parts if purchased separately...\$804.90

800999X1 Special Kit Price.....\$724.00/kit

RUBBER SEALS FOR 1961 LARK 2-DOOR HARDTOP

- (A) **800400X5** Front of door seal on body \$16.00 pr.
- (B) **1331996-7** Rear of door seal on body \$86.00 pr.
- (C) **800401X4** Sill seal \$18.00 pr.
- (D) **1328454** Window stop. Takes 2 \$15.00 ea.
- (E) **1331620-1** Vertical seal \$20.00 pr.
- (F) **1337344-5** Door corner seal \$22.00 pr.
- 3139X2** Cowl seal \$16.50 ea.
- *770012** Rear glass seal \$70.00 ea.
- 800252** Trunk seal \$40.00 ea.
- 800507X10** Window run (cat whiskers) \$90.00/set 6

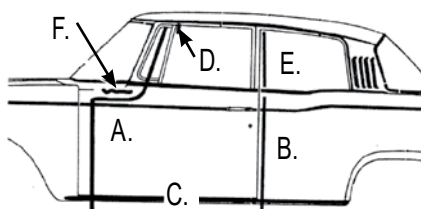

- 1320725** Vent window division seal \$22.00 ea.
- 1331926-7** Above door seal \$160.00 ea.
- 1332310-1** Front vent window seal \$150.00 pr.
- 1343119** Windshield seal \$160.00 ea.

**Required gluing ends.*

Kit without windshield and back glass seals.

- Total of all parts if purchased separately \$824.25
- 801003X1 Special Kit Price** \$741.00/kit

Kit contains all seals listed to the left including door, glass, trunk and cowl.

KIT ALSO INCLUDES

- 40 **1882X1** window run clips
- 2 **261419** gas lid bumpers
- 1 **800023** weatherstrip adhesive tube
- 2 **800852** vent window "U" channels
- 6 **1339574X1** hood bumpers
- 2 **1332093X2** hood bumpers

Kit with windshield and back glass seals.

- Total of all parts if purchased separately \$1,074.25

- Special Kit Price** \$966.00/kit
- 10% quantity discount. See page 6 \$96.60

801003R

Your Price \$869.40/kit

NOTE: When ordering specify year and model of car. No substitutions, deletions or returns of individual kit parts.

RUBBER SEALS FOR 1961 LARK 2-DOOR SEDAN

- (A) **800400BX11** Around door seal, front \$41.40 pr.
- (B) **800401X4** Sill seal \$18.00 pr.
- (C) **1337344-5** Door corner seal \$22.00 pr.
- 3139X2** Cowl seal \$16.50 ea.
- 310736-7** Front vent window seal \$130.00 pr.
- 310738** Vent window division seal \$22.00 ea.
- *770012** Rear glass seal \$70.00 ea.
- 800252** Trunk seal \$40.00 ea.
- 800504** Window "U" channel. Front .. \$39.75 ea.

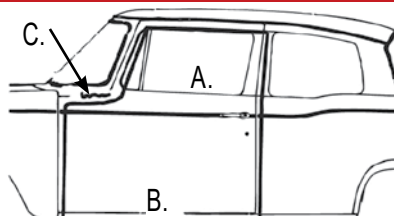

- 800504X8** Window "U" channel. Rear \$74.00 ea.
- 800507X6** Window run (cat whiskers) \$90.00/set 8
- 800851** Vent window "U" channels ... \$31.25 ea.
- 1343119** Windshield seal \$160.00 ea.

** Requires gluing ends.*

Kit without windshield and back glass seals.

- Total of all parts if purchased separately \$777.50
- 801468X1 Special Kit Price** \$699.00/kit

Kit contains all seals listed to the left including door, glass, trunk and cowl. Kit also includes most of the following.

KIT ALSO INCLUDES

- 30 **1624X1** window run clip
- 2 **261419** gas lid bumpers
- 2 **271475** "U" channel clip
- 1 **800023** weatherstrip adhesive tube
- 6 **1339574X1** hood bumpers
- 2 **1332093X2** hood bumpers

Kit with windshield and back glass seals.

- Total of all parts if purchased separately \$1,027.50

- Special Kit Price** \$924.00 /kit
- 10% quantity discount. See page 6 \$92.40

801468R

Your Price \$831.60/kit

NOTE: When ordering specify year and model of car. No substitutions, deletions or returns of individual kit parts.

RUBBER SEALS FOR 1961 LARK 4-DOOR SEDAN

- (A) **800400BX11** Around door seal, front \$41.40 pr.
- (B) **800400BX11** Around door seal, rear \$41.40 pr.
- (C) **800401X4** Sill seal, front or rear \$18.00 pr.
- (D) **1337344-5** Door corner seal \$22.00 pr.
- 3139X2** Cowl seal \$16.50 ea.
- 310736-7** Front vent window seal \$130.00 pr.
- 310738** Vent window division seal \$22.00 ea.
- *770012** Rear glass seal \$70.00 ea.
- 800252** Trunk seal \$40.00 ea.
- 800504** Front window "U" channel.... \$39.75 ea.

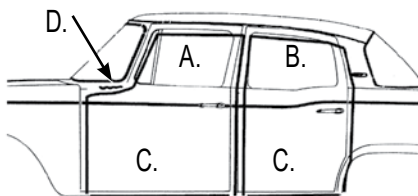

- 800504X8** Rear window "U" channel \$74.00 ea.
- 800507X7** Window run (cat whiskers) \$90.00/set 8
- 800851** Vent window "U" channel \$31.25 ea.
- 1343119** Windshield seal \$160.00 ea.

**Requires gluing ends.*

Kit without windshield and back glass seals.

Total of all parts if purchased separately	\$848.90
Special Kit Price	\$764.00 /kit
-10% quantity discount. See page 6	\$76.40
801469X1 Your Price	\$687.60/knit

Kit contains all seals listed to the left for each model including door, glass, trunk, and cowl.

KIT ALSO INCLUDES

- 40 **1624X1** window run clip
- 2 **261419** gas filler lid bumpers
- 4 **271475** "U" channel clip
- 1 **800023** weatherstrip adhesive tube
- 6 **1339574X1** hood bumpers
- 2 **1332093X2** hood bumpers

Kit with windshield and back glass seals.

Total of all parts if purchased separately	\$1,098.90
--	------------

Special Kit Price **\$989.00 /kit**

-10% quantity discount. See page 6 \$98.90

801469R
Your Price **\$890.10/knit**

NOTE: When ordering specify year and model of car. No substitutions, deletions or returns of individual kit parts.

RUBBER SEALS FOR 1961 CRUISER

- (A) **800400X11** Around door seal, front \$36.00 pr.
- (B) **800400X11** Around door seal, rear \$36.00 pr.
- (C) **800401X4** Sill seal, front or rear \$18.00 pr.
- (D) **1337344-5** Door corner seal \$22.00 pr.
- 3139X2** Cowl seal \$16.50 ea.
- 310736-7** Front vent window seal \$130.00 pr.
- 310738** Vent window division seal \$22.00 ea.
- *770012** Rear glass seal \$70.00 ea.
- 800252** Trunk seal \$40.00 ea.
- 800504** Window "U" channel. Takes 4 \$39.75 ea.

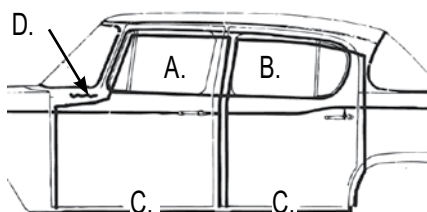

- 800507X7** Window run (cat whiskers) \$90.00/set 8
- 800851** Front vent window "U" channel. Takes 2 \$31.25 ea.
- 800851X3** Vent Window "U" channel. Rear \$31.25 ea.
- 1343119** Windshield seal. \$160.00 ea.

Kit without windshield and back glass.

Total of all parts if purchased separately	\$818.20
801413X1	
Special Kit Price	\$736.00/knit

Kit contains all seals listed to the left for each model including door, glass, trunk and cowl.

KIT ALSO INCLUDES

- 40 **1624X1** window run clip
- 2 **261419** gas filler lid bumpers
- 4 **271475** "U" channel clip
- 1 **800023** weatherstrip adhesive tube
- 6 **1339574X1** hood bumpers
- 2 **1332093X2** hood bumpers

Kit with windshield and back glass seals.

Total of all parts if purchased separately	\$1,068.20
--	------------

Special Kit Price **\$961.00/knit**

-10% quantity discount. See page 6 \$96.10

801413R
Your Price **\$864.90/knit**

NOTE: When ordering specify year and model of car. No substitutions, deletions or returns of individual kit parts.

RUBBER SEALS FOR 1962 LARK 2-DOOR SEDAN

- (A) **800400BX11** Around door seal.....\$41.40 pr.
- (B) **800401X4** Sill seal.....\$18.00 pr.
- (C) **1337344-5** Door corner seal.....\$22.00 pr.
- 3139X2** Cowl seal.....\$16.50 ea.
- 3167X1** Rear glass seal.....\$99.00 ea.
- 310736-7** Front vent window seal...\$130.00 pr.
- 310738** Vent window division seal.....\$22.00 ea.
- 800252** Trunk seal.....\$40.00 ea.
- 800504** Window "U" channel. Front.....\$39.75 ea.
- 800504X8** Window "U" channel. Rear.....\$74.00 ea.

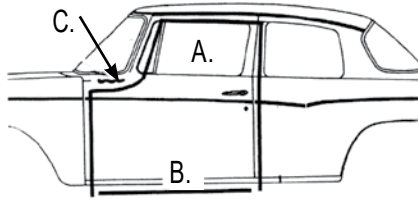

- 800507X6** Window run (cat whiskers).....\$90.00/set 8
- 800851** Vent window "U" channels.....\$31.25 ea.
- 1343119** Windshield seal.....\$160.00 ea.

Kit contains all seals listed to the left for each model including door, glass, trunk, and cowl.

KIT ALSO INCLUDES

- 30 **1624X1** window run clip
- 2 **271475** "U" channel clip
- 1 **800023** weatherstrip adhesive tube
- 6 **1339574X1** hood bumpers
- 2 **1332093X2** hood bumpers

Kit without windshield and back glass seals.

Total of all parts if purchased separately\$777.50

801471X1

Your Price.....\$699.00/kit

Kit with windshield and back glass seals.

Total of all parts if purchased separately\$1,056.50

Special Kit Price\$950.00/kit

-10% quantity discount. See page 6.....\$95.00

801471R

Your Price.....\$855.00/kit

NOTE: When ordering specify year and model of car. No substitutions, deletions or returns of individual kit parts.

RUBBER SEALS FOR 1962 LARK 4-DOOR SEDAN & CRUISER

- (A) **800400BX11** Around door seal, front.....\$41.40 pr.
- (B) **800400BX11** Around door seal, rear.....\$41.40 pr.
- (C) **800401X4** Sill seal, front or rear.....\$18.00 pr.
- (D) **1337344-5** Door corner seal.....\$22.00 pr.
- 3139X2** Cowl seal.....\$16.50 ea.
- 3167X1** Rear glass seal.....\$99.00 ea.
- 310736-7** Front vent window seal...\$130.00 ea.
- 310738** Vent window division seal.....\$22.00 ea.
- 800252** Trunk seal.....\$40.00 ea.
- 800504** Window "U" channel.....\$39.75 ea.
- 800504X8** Window "U" channel (except Cruiser).....\$74.00 ea.

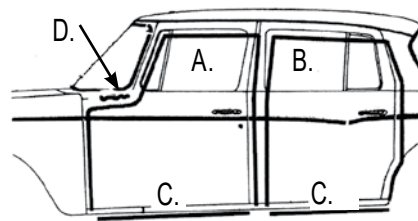

- 800507X7** Window run (cat whiskers).....\$90.00/set 8
- 800851** Vent window "U" channel (Includes 2).....\$31.25 ea.
- 1343119** Windshield seal.....\$160.00 ea.

Kit contains all seals listed to the left for each model including door, glass, trunk, and cowl.

KIT ALSO INCLUDES

- 40 **1624X1** window run clip
- 4 **271475** "U" channel clip
- 1 **800023** weatherstrip adhesive tube
- 6 **1339574X1** hood bumpers
- 2 **1332093X2** hood bumpers

Kit with windshield and back glass seals.

Total of all parts if purchased separately\$1,103.90

Special Kit Price\$993.00/kit

-10% quantity discount. See page 6.....\$99.30

801471R Your Price.....\$893.70/kit

Kit without windshield & back glass seals.

Total of all parts if purchased separately ...\$824.90

801472X1 Special Kit Price.....\$742.000/kit

NOTE: When ordering specify year and model of car. No substitutions, deletions or returns of individual kit parts.

RUBBER SEALS FOR 1962 LARK 2-DOOR HARDTOP

- (A) **800400X5** Front of door seal on body..... \$16.00 pr.
- (B) **1331996-7** Rear of door seal on body..... \$86.00 pr.
- (C) **800401X4** Sill seal..... \$18.00 pr.
- (D) **1328454** Window stop. Takes 2. \$15.00 ea.
- (E) **1331620-1** Vertical seal..... \$20.00 pr.
- (F) **1337344-5** Door corner seal..... \$22.00 pr.
- (G) **1331926-7** Above door seal..... \$160.00 pr.
- 3139X2** Cowl seal..... \$16.50 ea.
- 3167X1** Rear glass seal..... \$99.00 ea.
- 800252** Trunk seal..... \$40.00 ea.
- 800507X10** Window run (cat whiskers)..... \$90.00/set 6

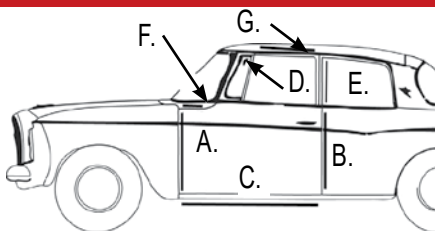

- 801100** Rear quarter outer seal..... \$30.00 pr.
- 1320725** Vent window division seal..... \$22.00 ea.
- 1332310-1** Front vent window seal..... \$150.00 pr.
- 1343119** Windshield seal..... \$160.00 ea.

Kit contains all seals listed to the left including door, glass, trunk and cowl.

KIT ALSO INCLUDES

- 40 **1882X1** window run clips
- 1 **800023** weatherstrip adhesive tube
- 2 **800852** vent window "U" channels
- 6 **1339574X1** hood bumpers
- 2 **1332093X2** hood bumpers

Kit with windshield and back glass seals.
 Total of all parts if purchased separately \$1,133.25
Special Kit Price \$1,019.00/kit
 -10% quantity discount. See page 6..... \$101.90
801470R Your Price \$917.10/kit

Kit without windshield & back glass seals.
 Total of all parts if purchased separately \$854.25
Special Kit Price \$768.00/kit
 -10% quantity discount. See page 6..... \$76.80
801470X1 Your Price \$691.20/kit

NOTE: When ordering specify year and model of car. No substitutions, deletions or returns of individual kit parts.

RUBBER SEALS FOR 1962-64 GRAN TURISMO HAWK

- (A) **1347012-3** Windshield post seal..... \$24.00 pr.
- (B) **1347010-1** Above door seal..... \$160.00 pr.
- (C) **1343342** Vertical seal..... \$20.00 pr.
- (D) **1347016-7** Rear of door seal with molded top..... \$100.00 pr.
- (E) **800401X4** Sill seal..... \$18.00 pr.
- (F) **303928-9** Front of door seal..... \$36.50 pr.
- (G) **1347014-5** Upper corner seal..... \$30.00 pr.
- (H) **770153** Under windshield post moulding seal..... \$10.00 pr.
- (I) **1992X1** Glass setting channels..... \$10.50 ea.
- (J) **304181** Liner, front window guide..... \$45.00 ea.
- 1770X1** Upper glass setting channel. Front..... \$14.00 ea.
- 1942X1** Windshield seal..... \$99.00 ea.
- 298965** Cowl seal..... \$16.50 ea.
- 307546-7** Vent window lower extension seal..... \$22.00 pr.
- 800507X12** Window run (cat whiskers)..... \$55.00/set 6

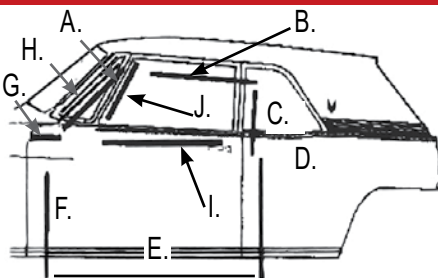

- 801100** Outer rear quarter window seal & clips .. \$30.00 pr.
- 801697** Seal, vent window stop. Takes 2. \$4.50 ea.
- 1343726** Rear glass seal..... \$99.00 ea.
- 1347005** Vent window division seal..... \$22.00 ea.
- 1347006-7** Front vent window seal..... \$130.00 pr.
- 1347074** Trunk seal with spliced upper corners..... \$70.00 ea.

Kit contains all seals listed to the left for each model including door, glass, trunk and cowl.

KIT ALSO INCLUDES

- 30 **1624X1** window run clips
- 8 **1882X1** window run clips
- 2 **261419** gas filler lid bumpers
- 12 **274974** hood bumpers
- 2 **284991** air vent lid seals
- 5 **287427** bumper, rear gravel deflector
- 1 **800023** weatherstrip adhesive tube
- 2 **1351407** hood bumpers

Kit with windshield and back glass seals.
 Total of all parts if purchased separately \$1,241.35
Special Kit Price \$1,117.00/kit
 -10% quantity discount. See page 6..... \$111.70
801008R Your Price..... \$1,005.30/kit

Kit without windshield & back glass seals.
 Total of all parts if purchased separately \$1,021.35
Special Kit Price \$919.00/kit
 -10% quantity discount. See page 6..... \$91.90
801008X1 Your Price \$827.10/kit

NOTE: When ordering specify year and model of car. No substitutions, deletions or returns of individual kit parts.

RUBBER SEALS FOR 1963 LARK 2-DOOR HARDTOP

- (A) **800405** Front of door seal on body..... \$40.00 pr.
- (B) **1331996-7** Rear of door seal on body..... \$86.00 pr.
- (C) **800401X4** Sill seal..... \$18.00 pr.
- (D) **1351746-7** Windshield post seal on door.... \$65.00 pr.
- (E) **1328454** Window stop. Takes 2..... \$15.00 ea.
- (F) **1331620-1** Vertical seal..... \$20.00 pr.
- 3139X2** Cowl seal..... \$16.50 ea.
- 800252** Trunk seal..... \$40.00 ea.
- 800507X16** Window run (cat whiskers)..... \$70.00/set 6
- 801100** Outer rear quarter window seal & clips.. \$30.00 pr.
- 1320725** Vent window division seal..... \$22.00 ea.

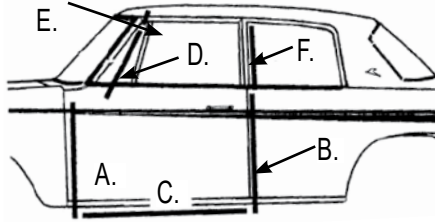

- 1339574X1** Hood bumpers. Takes 6..... \$1.50 ea.
- 1352662-3** Front vent window seal..... \$130.00 pr.
- 1353355** Windshield seal..... \$160.00 ea.
- 1353365** Rear glass seal..... \$160.00 ea.

Kit contains all seals listed to the left for each model including door, glass, trunk and cowl.

KIT ALSO INCLUDES

- 2 **800852** vent window "U" channels
- 30 **1882X1** window run clips
- 1 **800023** weatherstrip adhesive tube
- 2 **1332093X2** hood bumpers

Kit with windshield and back glass seals.

Total of all parts if purchased separately \$1,056.70
Special Kit Price **\$951.00/kit**
 -10% quantity discount. See page 6..... \$95.10

801005R

Your Price **\$855.90/kit**

Kit without windshield & back glass seals.

Total of all parts if purchased separately ... \$736.70

801005X1

Special Kit Price **\$663.00/kit**

NOTE: When ordering specify year and model of car. No substitutions, deletions or returns of individual kit parts.

RUBBER SEALS FOR 1963-66 4-DOOR STATION WAGON

Kit contains all seals listed below left for each model including door, glass and cowl.

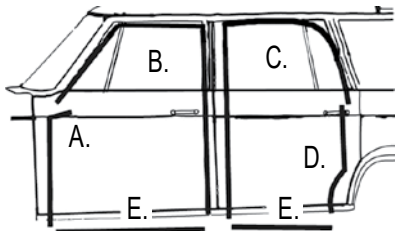

- (A) **800405** Front of door seal on body..... \$40.00 pr.
- (B) **1351730-1** Upper door & sides..... \$112.00 pr.
- (C) **1360350-1** Upper door seal, rear..... \$90.00 pr.
- (D) **1355352-3** Rear of door seal on body..... \$65.00 pr.
- (E) **800401X4** Sill seal, front or rear..... \$18.00 pr.
- 800507X14** Window run (cat whiskers)..... \$90.00/set 8
- 3139X2** Cowl seal..... \$16.50 ea.
- 1353355** Windshield seal..... \$160.00 ea.

For Vent Window Division Seal
See Page 61

KIT ALSO INCLUDES

- 20 **3235X1** window run clips
- 2 **1552311** hood bumper (1964-66)
- 1 **800023** weatherstrip adhesive tube
- 4 **800505** window "U" channel
- 2 **800851X1** vent window "U" channel
- 2 **800851X4** vt window "U" channel, rear
- 2 **1352974** tailgate bumper
- 6 **1339574X1** hood bumpers (all)
- 2 **1332093X2** hood bumpers. Takes 2 (1963 only)

Note: Tail gate seals, rear quarater window seal, rear glass seal & seals for sliding roof are not part of this kit. Inquire for availability & price at (317) 462-3124.

Kit with windshield seals.

Total of all parts if purchased separately \$978.30
Special Kit Price **\$880.00/kit**
 -10% quantity discount. See page 6..... \$88.00
801013R Your Price **\$792.00/kit**

Kit without windshield seals.

Total of all parts if purchased separately \$818.30
801013X1 Your Price **736.00/kit**

**For front vent window assemblies which include Weatherseals see page 50.
 For rear door vent window assemblies see page 52.**

NOTE: When ordering specify year and model of car. No substitutions, deletions or returns of individual kit parts.

RUBBER SEALS FOR 1963 4-DOOR SEDAN

- (A) **800405** Front of door seal on body.....
.....\$40.00 pr.
- (B) **1351730-1** Upper door & sides. \$112.00 pr.
- (C) **1360350-1** Upper door seal, rear.....
.....\$90.00 pr.
- (D) **1355352-3** Rear of door seal on body.....
.....\$65.00 pr.
- (E) **800401X4** Sill seal, front or rear.....
.....\$18.00 pr.
- 3139X2** Cowl seal..... \$16.50 ea.
- 800252** Trunk seal..... \$40.00 ea.
- 800505** Window "U" channels. Takes 4.....
.....\$45.90 ea.
- 800507X14** Window run (cat whiskers).....
.....\$90.00/set 8

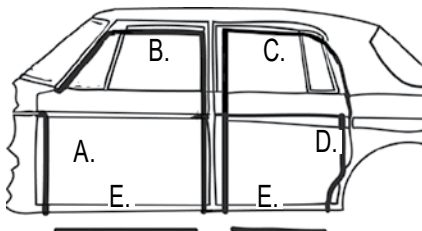

- 800851X1** Front vent window "U" channels.
Takes 2..... \$31.25 ea.
- 800851X4** Rear vent window "U" channels.
Takes 2..... \$31.25 ea.
- 1353355** Windshield seal..... \$160.00 ea.
- 1353365** Rear glass seal..... \$160.00 ea.

Kit contains all seals listed to the left including door, glass, cowl and trunk.

KIT ALSO INCLUDES

- 20 **3235X1** window run clips
- 1 **800023** weatherstrip adhesive tube
- 6 **1339574X1** hood bumpers
- 2 **1332093X2** hood bumpers

Kit with windshield and back glass seals.
Total of all parts if purchased separately \$1,174.80
..... \$1,174.80
Special Kit Price **\$1,057.00/kit**
-10% quantity discount. See page 6..... \$105.70
801009R Your Price..... **\$951.30/kit**

Kit without windshield & back glass seals.
Total of all parts if purchased separately \$854.80
..... \$854.80
Special Kit Price **\$769.00/kit**
-10% quantity discount. See page 6..... \$76.90
801009X1 Your Price **\$692.10/kit**

*For front vent window assemblies which include Weatherseals see page 50.
For rear door vent window assemblies see page 52.*

For Vent Window Division Seal See Page 61

NOTE: When ordering specify year and model of car. No substitutions, deletions or returns of individual kit parts.

RUBBER SEALS FOR 1963 2-DOOR SEDAN

- (A) **800405** Front of door seal on body.....
.....\$40.00 pr.
- (B) **1351742-3** Upper door & sides.....
.....\$105.00 pr.
- (C) **800401X4** Sill seal..... \$18.00 pr.
- (D) **1351744-5** Rear of door..... \$42.00 pr.
- 3139X2** Cowl seal..... \$16.50 ea.
- 800252** Trunk seal..... \$40.00 ea.
- 800505** Front window "U" channel.... \$45.90 ea.
- 800505X8** Rear window "U" channel.....
.....\$50.25 ea.
- 800507X13** Window run (cat whiskers) Front....
.....\$45.00/set 4

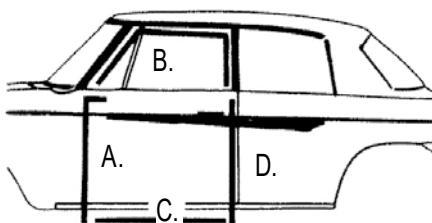

- 800851X1** Vent window "U" channels.....
.....\$31.25 ea.
- 1353355** Windshield seal..... \$160.00 ea.
- 1353365** Rear glass seal..... \$160.00 ea.

Kit contains all seals listed to the right including doors, glass, cowl and trunk.

KIT ALSO INCLUDES

- 20 **1624X1** window run clips
- 20 **3235X1** window run clips
- 1 **800023** weatherstrip adhesive tube
- 6 **1339574X1** hood bumpers
- 2 **1332093X2** hood bumpers

Kit with windshield and back glass seals.
Total of all parts if purchased separately ... \$941.90
Special Kit Price **\$847.00 /kit**
-10% quantity discount. See page 6..... \$84.70
801011R Your Price..... **\$762.30/kit**

Kit without windshield & back glass seals.
Total of all parts if purchased separately ... \$621.90
801011X1
Special Kit Price **\$559.00/kit**

For Vent Window Division Seal See Page 61.

Note: Vent Window seals are also available as part of the complete vent window assembly featured on page 61.

NOTE: When ordering specify year and model of car. No substitutions, deletions or returns of individual kit parts.

RUBBER SEALS FOR 1963-64 CONVERTIBLE

- (A) **800405** Front of door seal on body..... \$40.00 pr.
- (B) **1331996-7** Rear of door seal on body..... \$86.00 pr.
- (C) **800401X4** Sill seal..... \$18.00 pr.
- (D) **800362** Above door seal. 5' - enough for 1 side..... \$37.85 ea.
- (E) **1351746-7** Windshield post seal on door \$65.00 pr.
- (F) **1328454** Window stop. Takes 2.. \$15.00 ea.
- (G) **1331620-1** Vertical seal \$20.00 pr.
- 3112X2** Above windshield header front seal, 1960-64 convertibles..... \$22.00 ea.
- 3139X2** Cowl seal..... \$16.50 ea.
- 800252** Trunk seal..... \$40.00 ea.
- 1320725** Vent window division seal.. \$22.00 ea.
- 1339015** Above windshield moulded header seal..... \$75.00 ea.

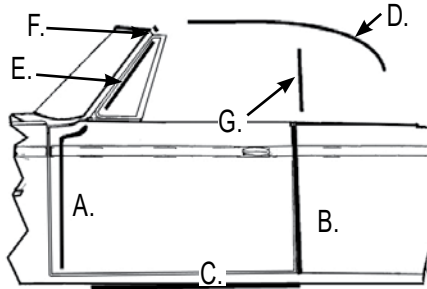

- 1339574X1** Hood bumpers. Takes 6..... \$1.50 ea.
- 1352662-3** Front vent window seal..... \$130.00 pr.
- 1353355** Windshield seal..... \$160.00 ea.
- 1552311** Hood bumpers. 1964 only. Takes 2..... \$3.75 ea.

Kit without windshield seal.

- Total of all parts if purchased separately \$901.90
- Special Kit Price** \$811.00/kit
- 10% quantity discount. See page 6..... \$81.10
- 801007X1 Your Price** \$729.90/kit

NOTE: When ordering specify year and model of car. No substitutions, deletions or returns of individual kit parts.

Kit contains all seals listed to the left for each model including door, glass, trunk and cowl.

KIT ALSO INCLUDES

- 30 **1882X1** window run clips
- 8 **800507X15** window run
- 2 **800852** vent window "U" channels
- 1 **800023** weatherstrip adhesive tube
- 2 **1332093x2** hood bumpers. 1963 only

Kit with windshield seal.

- Total of all parts if purchased separately \$1,061.90
- Special Kit Price** \$955.00/kit
- 10% quantity discount. See page 6..... \$95.50

801007R

Your Price..... \$859.50/kit

RUBBER SEALS FOR 1964 2-DOOR HARDTOP

- (A) **800405** Front of door seal on body..... \$40.00 pr.
- (B) **1331996-7** Rear of door seal on body..... \$86.00 pr.
- (C) **800401X4** Sill seal..... \$18.00 pr.
- (D) **1360130-1** Windshield post seal on door..... \$50.00 pr.
- (E) **1328454** Window stop. Takes 2.. \$15.00 ea.
- (F) **1331620-1** Vertical seal..... \$20.00 pr.
- 3139X2** Cowl seal..... \$16.50 ea.
- 800252** Trunk seal..... \$40.00 ea.
- 800507X16** Window run (cat whiskers)..... \$70.00/set 6
- 800852** vent window U-channels. (2)..... \$31.15 ea.
- 1358516-7** Outer rear quarter window seal & clips \$30.00 pr.
- 1339574X1** Hood bumpers. Takes 6..... \$1.50 ea.

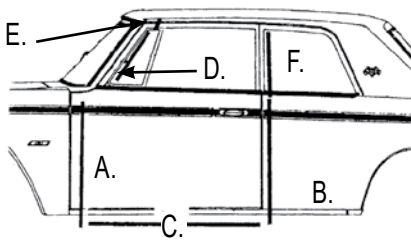

- 1356924-5** Front vent window seal..... \$130.00 pr.
- 1356932** Vent window division seal . \$22.00 ea.
- 1356991** Windshield seal..... \$160.00 ea.
- 1358001** Rear glass seal..... \$130.00 ea.

Above door seal
call for availability and price.

Kit contains all seals listed on the left & below for each model including door, glass, trunk and cowl.

KIT ALSO INCLUDES

- 30 **1882X1** window run clips
- 1 **800023** weatherstrip adhesive tube
- 2 **1552311** hood bumpers

Kit with windshield and back glass seals.

- Total of all parts if purchased separately \$999.25
- Special Kit Price** \$899.00/kit
- 10% quantity discount. See page 6..... \$89.90
- 801006R Your Price**..... \$809.10/kit

Kit without windshield & back glass seals.

- Total of all parts if purchased separately .. \$709.25
- 801006X1**
- Special Kit Price** \$638.00/kit

Note: Vent Window seals are also available as part of the complete vent window assembly featured on page 50.

NOTE: When ordering specify year and model of car. No substitutions, deletions or returns of individual kit parts.

RUBBER SEALS FOR 1964-66 2-DOOR SEDAN

- (A) **800405** Front of door seal on body.....
.....\$40.00 pr.
- (B) **1360134-5** Upper door & sides.....
.....\$150.00 pr.
- (C) **800401X4** Sill seal.....\$18.00 pr.
- (D) **1351744-5** Rear of door.....\$42.00 pr.
- 3139X2** Cowl seal.....\$16.50 ea.
- 800252** Trunk seal.....\$40.00 ea.
- 800505** Front window "U" channel....\$45.90 ea.
- 800505X8** Rear window "U" channel.....
.....\$50.25 ea.
- 800507X13** Front window run (cat whiskers).....
.....\$45.00/set 4

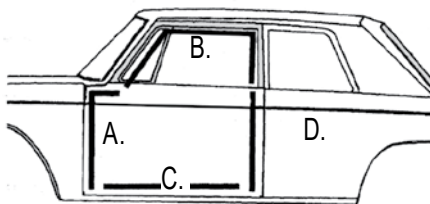

- 1339574X1** Hood bumpers. Takes 6.....
.....\$1.50 ea.
- 1356991** Windshield seal.....\$160.00 ea.
- 1358001** Rear glass seal.....\$130.00 ea.
- 1358497** Rear glass seal (1964 Challenger
without moulding).....\$130.00 ea.
- 1552311** Hood bumpers. Takes 2.....\$3.75 ea.

For Vent Window Division Seal See page 61.

NOTE: Front vent window seals are not available.

Kit without windshield and back glass seals.

- Total of all parts if purchased separately\$654.10
- 801012X1**
- Special Kit Price**\$588.00/kit

Kit contains all seals listed to the left for each model including door, glass, trunk and cowl.

KIT ALSO INCLUDES

- 20 **1624X1** window run clips
- 20 **3235X1** window run clips
- 1 **800023** weatherstrip adhesive tube
- 2 **800851X2** vent window "U" channel

Kit with windshield and back glass seals.

- Total of all parts if purchased separately\$944.10

- Special Kit Price**\$849.00/kit
- 10% quantity discount. See page 6.....\$84.90

- 801012R**
- Your Price**.....\$764.10/kit

NOTE: When ordering specify year and model of car. No substitutions, deletions or returns of individual kit parts.

RUBBER SEALS FOR 1964-66 LARK 4-DOOR SEDAN

- (A) **800405** Front of door seal on body.....
.....\$40.00 pr.
- (B) **1360132-3** Front upper door & sides.....
.....\$112.00 pr.
- (C) **1360350-1** Upper door seal, rear.....
.....\$90.00 pr.
- (D) **1355352-3** Rear of door seal on body.....
.....\$65.00 pr.
- (E) **800401X4** Sill seal, front or rear.....
.....\$18.00 pr.
- 3139X2** Cowl seal.....\$16.50 ea.
- 800252** Trunk seal.....\$40.00 ea.
- 800507X14** Window run (cat whiskers).....
.....\$90.00/set 8
- 1356991** Windshield seal.....\$160.00 ea.

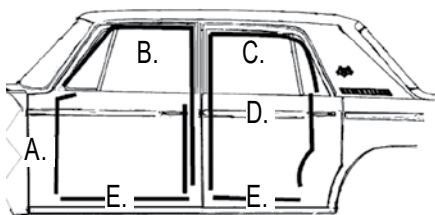

- 1358001** Rear glass seal.....\$130.00 ea.
- 1358497** Rear glass seal. 1964 Challenger
without moulding.....\$100.00 ea.
- 1339574X1** Hood bumpers. Takes 6.....\$1.50 ea.
- 1552311** Hood bumpers. Takes 2.....\$3.75 ea.

Kit without windshield & back glass seals.

- Total of all parts if purchased separately\$853.30
- Special Kit Price**\$767.00/kit
- 10% quantity discount. See page 6.....\$76.70
- 801010X1** **Your Price**.....\$690.30/kit

Kit contains all seals listed to the left for each model including door, glass, trunk and cowl.

KIT ALSO INCLUDES

- 1 **800023** weatherstrip adhesive tube
- 4 **800505** window "U" channels
- 2 **800851** vent window "U" channels
- 20 **3235X1** window run clips
- 2 **800851X5** vent window "U" channels, rear

Note: Front vent window seals are not available in this kit.

Kit with windshield and back glass seals.

- Total of all parts if purchased separately\$1,143.30

- Special Kit Price**\$1,028.00/kit
- 10% quantity discount. See page 6.....\$102.80

- 801010R**
- Your Price**.....\$925.20/kit

For Vent Window Division Seal See Page 61.

For rear door vent window assemblies including seals (Cruiser) and rear vent window seals (all) see page 52.

NOTE: When ordering specify year and model of car. No substitutions, deletions or returns of individual kit parts.

RUBBER SEALS FOR 1960-64 CHAMP TRUCK

- (A) **800400BX11** Around door seal..... \$41.40 pr.
- (B) **800401X4** Sill seal..... \$18.00 pr.
- (C) **1337344-5** Door corner seal..... \$22.00 pr.
- 1835X10** Rear glass vertical division seal.
- For models with sliding rear glass..... \$8.00 ea.
- 1942X2** Windshield seal..... \$99.00 ea.
- 298965** Hood to cowl seal..... \$16.50 ea.
- 310736-7** Front vent window seal..... \$130.00 pr.
- 310738** Vent window division seal... \$22.00 ea.
- 800507X11** Window run (cat whiskers)..... \$45.00/set 4
- 1655314** Rear glass seal with stationary glass... \$105.00 ea.

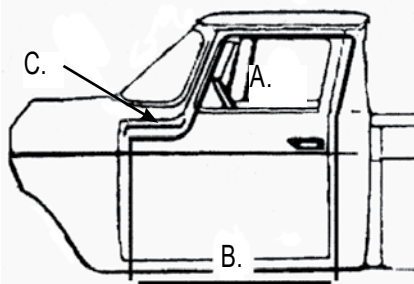

1655549X1 Rear glass seal kit for models with sliding glass. Includes rubber & channel. 3-pieces. \$260.00/kit

KIT CONTAINS ALL SEALS LISTED TO THE LEFT FOR EACH MODEL INCLUDING DOOR, GLASS, AND COWL.

KIT ALSO INCLUDES

- 20 **1624X1** window run clips
- 2 **271475** "U" channel clip
- 1 **272078** gas filler neck grommet
- 1 **800023** weatherstrip adhesive tube
- 2 **800504** window "U" channels
- 2 **800851** vent window "U" channels
- 6 **1339574X1** hood bumpers
- 2 **1332093X2** hood bumpers

1960-64 CHAMP TRUCK WITH SLIDING REAR GLASS

Includes Rear Glass Channel & Rubber Seal.

- Total of all parts if purchased separately \$898.50
- Special Kit Price** \$808.00/kit
- 10% quantity discount. See page 6 \$80.80
- 801121R Your Price**..... \$727.20/kit

1960-64 CHAMP TRUCK

(All) Kit without windshield and back glass rubber seals, or back glass channels

- Total of all parts if purchased separately \$539.50
- 801121X1 Special Kit Price**..... \$485.00/kit

1960-64 CHAMP TRUCK

Kit with stationary rear glass

- Total of all parts if purchased separately ... \$735.50
- 800984R Special Kit Price**..... \$661.00/kit

NOTE : When ordering specify year and model of truck. No substitutions or deletions.

RUBBER SEALS FOR 1963-83 (SOME 1985-89) AVANTI

COMPLETE KIT FOR 1963-83 AVANTI

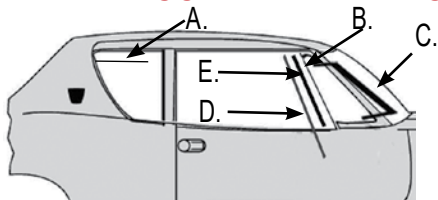

Kits Listed below contain Trunk, Cowl and all door and window seals including rear quarter window seals. Rear window and Windshield seals are only included in Kit 800688R

KIT ALSO INCLUDES

- (A) **3202X2** Above rear quarter horizontal seal... \$12.00 ea.
 - (B) **1328454** Window stop at top of front vent frame. 1963-89 Avanti..... \$15.00 ea.
 - (A) **1350538** Metal retainer strip for 3202X2..... \$15.00 ea.
 - (C) **1350564-5** Front vent window seal. 1963-89 Avanti \$130.00 pr.
 - (D) **1350572-3** Rigid "U" channel. Fits on edge of vent assembly and guides side glass rolling up & down \$145.00 pr.
 - (E) **1350577** Vent window division seal. 1963-89 Avanti \$25.00 ea.
 - 1358964-5** Rear quarter window seals. 1963-1983 Avanti..... \$150.00 pr.
 - 3177X3** Trunk seal. 1963-85 Avanti. \$40.00 ea.
 - 3207X2** Cowl seal. 1963-89 Avanti (Hood to body)..... \$15.00 ea.
 - 3260X1** Rear window seal. 1963-1989 Avanti \$120.00 ea.
 - 1350769** Windshield seal. 1963-89 Avanti..... \$160.00 ea.
- 3 **1552311** hood bumpers
 - 1 **800023** weatherstrip adhesive tube
 - 1 **1350997** gas lid bumper
 - 2 **1358964-5** rear quarter window seals
- Kit with windshield & back glass seals.**
- Total of all parts if purchased separately \$1,325.70
 - Special Kit Price** \$1,193.00/kit
 - 10% quantity discount. See page 6..... \$119.30
 - 800688R Your Price**..... \$1,073.70/kit
- Kit without windshield & back glass seals.**
- Total of all parts if purchased separately \$1,045.70
 - Special Kit Price** \$941.00/kit
 - 10% quantity discount. See page 6..... \$94.10
 - 800688X1 Your Price**..... \$846.90/kit
- NOTE: No substitutions, deletions or returns of individual kit parts.**

AVANTI DOOR

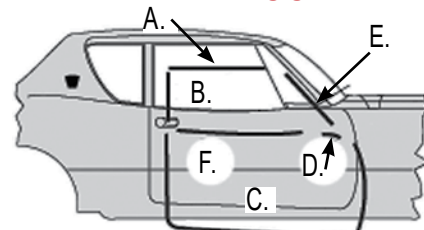

- (A) **1351334-5** Above door seal, 1963-83 Avanti \$160.00 pr.
- (B) **1350856-7** Rear upper door seal. 1963-83 Avanti \$60.00 pr.
- (C) **1350764-5** Around door seal. 1963-83 Avanti. New softer rubber..... \$48.00 pr.
- (D) **1350164-5** Door corner seal. 1963-83 Avanti \$24.00 pr.
- (E) **1360896-7** Front upper door seal on windshield post \$18.00 pr.
- (F) **1350963** Horizontal outer window seal. 1963-83 Avanti. \$24.00 ea.

SPECIAL DOOR SEAL KIT FOR 1963-83 AVANTI

Contains all seals listed A - F above.

- Total of all parts if purchased separately .. \$358.00
- 800542R Special Kit Price** \$322.00/kit

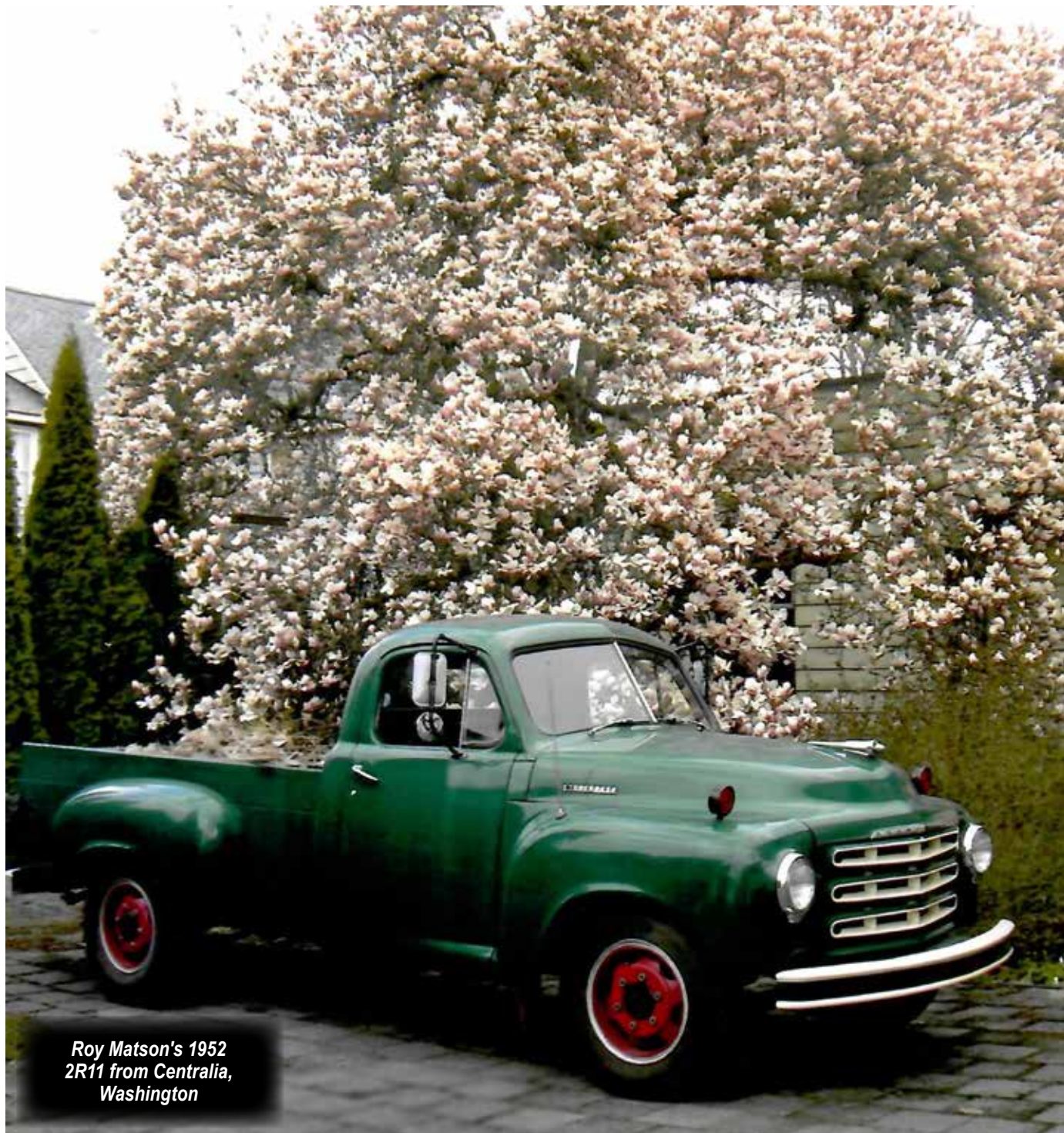

*Roy Matson's 1952
2R11 from Centralia,
Washington*

BODY SECTION GLOSSARY

How to identify the body style of your Studebaker.....	86	Emblem Kits	112-118
Convertible Top Parts	86-87	Brightworks Packages	118-128
Hood Related Parts	88-89	Supplemental Small Part Kits	128-130
Grilles & Grille Mouldings	89	Door	131-133
Bumpers & Related Parts	90-91	Trunk	133-134
Moulding Clip Kits.....	93-100	Station Wagon Tailgate Parts.....	135-137
Mouldings.....	100-112	Sheet Metal	138-146

LONG OR SHORT WHEELBASE 4-DOOR SEDAN



"W" Body
Short Wheelbase 4-dr. Sedan (SWB)

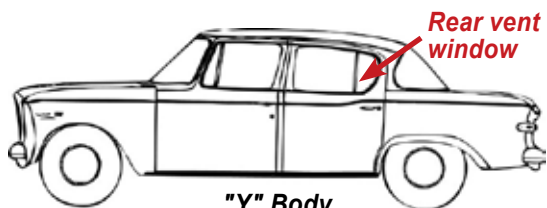

"Y" Body
Long Wheelbase 4-dr. Sedan (LWB)

The easiest way to tell whether it's a long (LWB) or a short (SWB) model is that the rear door on long wheelbase sedans contains their own vent window. This vent window opens on all but a few models. From 1947-54 all long wheelbase sedans are Land Cruiser models. All other 4-door models during these years are short wheelbase sedans and are Champion or Commander models. 1955 long wheelbase sedans

are called President State sedans. Short wheelbase 1955 sedans are designated as Champion, Commander or President models. 1956-57 long wheelbase sedans are called President Classic models and all 1958 Presidents are long wheelbase sedans. 1959-60 Lark sedans are all short wheelbase except for some taxis which were long wheelbase. 1961 Cruiser models used the long wheelbase and all other 1961 Larks were short wheelbase. 1962 Larks were all long wheelbase even though some models did not have the rear vent window. 1963-66 Larks were all long wheelbase.

B-Pillar



"F" Body

2-DOOR SEDAN

These have a post (B-pillar) separating the door glass from the rear quarter window glass and were available for all years.

Window flips outward for ventilation

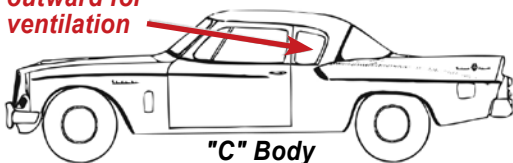

"C" Body

Stationary

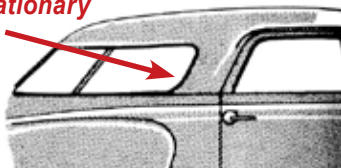

2-DOOR COUPE

These are similar to 2-door sedans except that the rear quarter windows do not roll down. The rear windows are either stationary or they flip outward for ventilation.



"J" Body



"K" Body

HARDTOP

Having a metal roof does not mean that your car is a hardtop. The easiest way to tell if your car is a hardtop is that it is a 2-door model and that there is no post (B-pillar) behind the front door and when both windows are rolled down, there is no pillar. The hardtop model was first introduced in 1952. From 1953-58 it was available as the "K-body" hardtop which remained available through 1958. In 1958 an additional hardtop was available designated the "J-body" hardtop and was available as a Studebaker Commander or President and also as a Packard. From 1959-64, the J-Body was the Lark. From 1962-64, the K-body hardtop was again available and named Gran Turismo Hawk.

CONVERTIBLE TOP MOTOR, PUMP & LIFT PARTS 1960-64

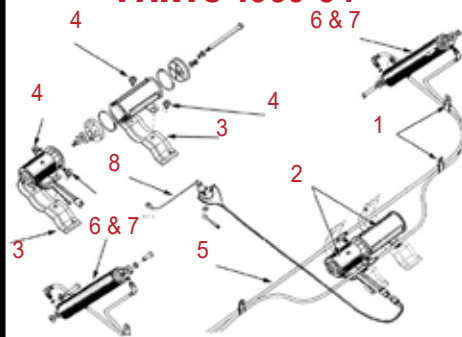

1. **533007** Retaining clip, hose to body. 1960-64.\$3.00 ea.
2. **1337080** Motor & pump assembly. 1960-64 ... \$485.00 ea.
3. **1338234** Bracket, motor & pump. 1961-64 \$21.50 ea.
4. **1336721** Mounting grommet, motor and pump to bracket. 1960-64 \$2.50 ea.
5. **1336798** Hose & fitting, cylinder & pump. 1960-64. Takes 2 \$78.95 ea.
6. **1337081** Lift cylinder. 1960 \$395.00 pr.
7. **1339014** Lift cylinder. 1961-64. \$395.00 pr.
8. **1339395** Cable, top switch to starter solenoid. 1961-64 \$8.50 ea.

NOS FOLDING TOP HINGES 1947-52 convertibles

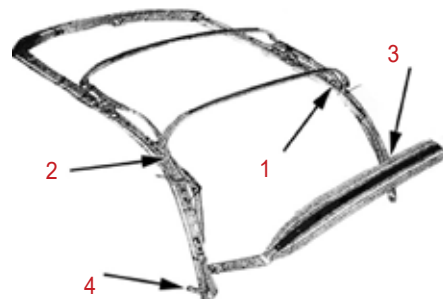

- #1 and #2 Hinge halves on diagram, right and left. 1947-49 cars all models.
- 287540P** Right, refer to diagram reference #1 \$125.00 ea.
- 287541P** Left, refer to diagram reference #2 \$125.00 ea.
- #1 and #2 Hinge halves, right and left. 1950-52 cars all models.
- 291508P** Right, refer to diagram reference #1..... \$125.00 ea.
- 291509P** Left, refer to diagram reference #2..... \$125.00 ea.
- #3 and #4 Hinge lower, right and left. 1950 -52 cars all models.
- 291504P** Right, refer to diagram reference #3..... \$125.00 ea.
- 291505P** Left, refer to diagram reference #4. \$125.00 ea.

CONVERTIBLE TOP MOTOR

- 291389** 1950 all models..... \$350.00 ea.
- 293459** Convertible top motor. 1951-52 car. Sold exchange only..... \$225.00 Ex.

FOR 1960-64 CARS

1. **1581X6W** Snap stud\$3.00 ea.
2. **3112X2** Above windshield front header seal, 1960-64 convertibles\$22.00 ea.
3. **307559** Bumper, folding top header. 1961-64. Not illustrated\$2.50 ea.
4. **800362** Above door seal. 5', enough for one side cut in 3-pieces. 1960-64\$37.85 ea.
5. **1334798** Drain w/screen, top well. 1960-64. Not illustrated\$5.00 ea.
6. **1334823** Pad, front & center bow. 1960-64\$15.00 ea.
7. **1334868** Rear window zipper. 1960-64\$15.50 ea.
8. **1336713P** Center bow assembly. 1960-64. Not illustrated\$75.00 ea.
9. **1336715P** Rear bow assembly, 1960-64\$95.00 ea.
9. **1336720** Arm, rear bow. 1960-64.\$22.50 ea.
10. **1336726** Right front rail w/hinge. 1960\$34.00 ea.
11. **1336727** Left front rail w/hinge. 1960\$40.00 ea.
12. **1336732** Right retainer, above door seal. 1960-64\$12.00 ea.
13. **1336733** Left retainer, above door seal. 1960-64\$13.25 ea.
14. **1336724** Right, retainer. 1960-61\$10.00 ea.
15. **1336740** Right operating link assembly. 1960-64\$60.00 ea.
16. **1336741** Left operating link assembly. 1960-64.\$60.00 ea.
17. **1336750** Right rear rail w/hinge. 1960-64\$140.00 ea.
18. **1336751** Left rear rail w/hinge. 1960-64\$140.00 ea.
19. **1336766** Right bracket, balance link pivot. 1960-64\$30.00 ea.
20. **1336767** Left bracket, balance link pivot. 1960-64\$30.00 ea.
21. **1336768** Right bracket, rear rail mounting. 1960-64\$40.00 ea.
22. **1336769** Left bracket, rear rail mounting. 1960-64\$40.00 ea.
23. **1336784** Screw to right side rail shoulder. 1960-64\$6.00 ea.
24. **1336785** Screw to left & center side rail shoulder. 1960-64\$6.00 ea.
25. **1336787** Pin, rear rail to bracket.\$4.50 ea.
26. **1336788** Nylon bushing, rear rail bracket pin. 1960-64\$2.50 ea.
27. **1336790** Nylon bushing, front side rail screw. 1960-64\$2.00 ea.
28. **1336796** Rivet, operating link shoulder. 1960-64\$5.00 ea.
30. **1336858** Rail with hinge, right center. 1960-64 ...\$40.00 ea.
31. **1336859** Rail with hinge, left center. 1960-64.\$40.00 ea.
32. **1336995W** Striker, top hold down clamp. 1960-64\$18.00 ea.
33. **1337069W** Hook, top hold down clamp. 1961-64. Cadmium plated - not chrome\$14.00 ea.
- 33A. **1337065** Clamp. 1960\$94.00 ea.

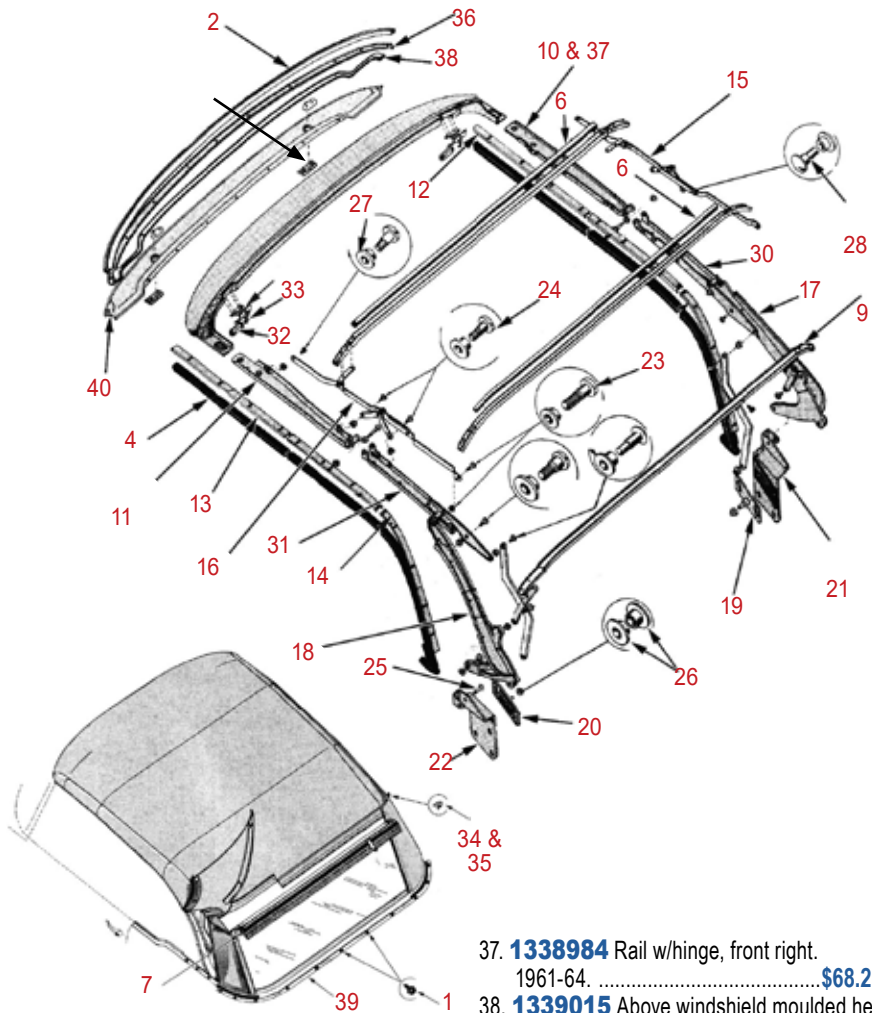

34. **1337170** Cap, right binding strip. 1960-64 ...\$2.00 ea.
35. **1337171** Cap. Left binding strip, 1960-64\$2.00 ea.
36. **1338778** Retainer, header front weatherstrip. 1961-64\$30.00 ea.
37. **1338984** Rail w/hinge, front right. 1961-64.\$68.25 ea.
38. **1339015** Above windshield moulded header seal, 1961-64\$75.00 ea.
39. **1339067** Moulding, deck lid upper panel. 1961.\$52.00 ea.
40. **1338475** Header, stainless steel cover. 1961-62\$75.00 ea.
40. **1353744** Moulding, above windshield header lower cover. 1963-64\$75.00 ea.

ROOF DRIP RAIL



- 303557** Roof drip rail stainless joiner. 1955-64 C&K and 1961-62 Lark\$7.50 ea.

VINYL ROOF COVERS

- 1359590X1** Black. 1964 Hawk. NOS\$217.25 ea.
- 1359590X2** White. 1964 Hawk. NOS\$217.25 ea.
- 1361134X1** Black. 1965-66 2-door. NOS\$195.00 ea.
- 1361134X2** White. 1965-66 2-door. NOS\$195.00 ea.
- 1361135X1** Black. 1965-66 4-door. NOS\$195.00 ea.
- 1361135X2** White. 1965-66 4-door. NOS\$195.00 ea.

CONVERTIBLE PUMP SEAL KIT



- 802040** 1960-64. Includes mounting grommets.\$20.00 ea.

HOOD BUMPERS

274974 1941-58 all cars. Takes 10. 1947 & later takes 10. 1953-58 C&K. Takes 12. 1959-64 Hawk. Takes 12. Truck: 1949-64 C-cab truck. Takes 10 **85¢ ea.**

287528 1947-49 car. 1949-55 truck. Takes 2 **\$4.00 ea.**

289864 Front. 1950-58 car, all models. Truck: 1956-64 C-cab. Takes 2 **\$3.00 ea.**

649117 4-piece set. All M-series Truck **\$12.00/set**

1312038 1956-62 Hawk. Takes 2 **\$3.50 ea.**

1332093X2 1959-63 Lark on nose panel **\$2.50 ea.**

1351407 Front. 1963-64 Hawk. Takes 2 **\$3.50 ea.**

1339574X1 1959-66 Lark. Truck: 1960-64 Champ. Takes 6 **\$1.50 ea.**

1552311 1964-66 Lark, front. Takes 2. Also 1963-89 Avanti. Takes 3 **\$3.75 ea.**

1352974 Tailgate bumper. 1963-66 station wagon. Takes 2 **\$2.50 ea.**

HOOD HINGES



298270-1 1953-55 sedan. 1955 with straight windshield only **\$36.00 pr.**

303068-9 Right and left, 1953-64 C & K **\$220.00 pr.**

1955 with curved windshield. 1956-58 sedan. 1959-60 Lark, Truck: 1960 - 64 Pickup

310298 Right **\$45.00 ea.**

310299 Left **\$45.00 ea.**

1338622 Right hinge. 1961-63 Lark **\$36.50 ea.**

1338623 Left hinge. 1961-63 Lark ... **\$36.50 ea.**

1356180 Right hinge. 1964-66 Lark. **\$36.50 ea.**

1356181 Left hinge. 1964-66 Lark ... **\$36.50 ea.**



1358934 Right. 1963-89 Avanti **\$75.00 ea.**

1358935 Left. 1963-89 Avanti **\$75.00 ea.**

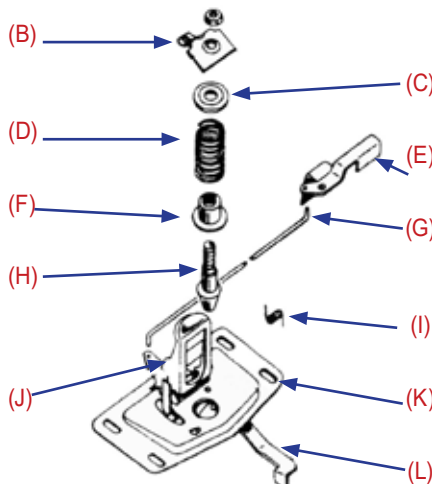

(B) **1314115** Catch, hood safety hook. 1956-64 Hawk **\$15.00 ea.**

(J) **1314995** Hook, hood safety catch. 1957-62 Hawk **\$16.50 ea.**

(D) **274906** Spring. 1941-42 Champion, Commander, and President. Plus 1954-55 car **\$10.00 ea.**

(F) **274907** Lower retainer. 1941-42 Champion, Commander, and President. Plus 1954-55 car **\$6.50 ea.**

(H) **284526** Dovetail. 1947-54 & 1959-66 car except C & K. Truck: 1960-64 Champ **\$45.00 ea.**

(C) **286105** Upper retainer. 1947-66 car. Truck: 1949-64 C-cab and 1960-64 Champ **\$4.95 ea.**

(F) **308747** Retainer for lower hood latch spring. 1955- early 57 car and 1957-64 C&K **\$8.50 ea.**

(D) **308748P** Spring. 1955 car, late 1957-58 sedan, & 1958 Packard Hawk **\$9.50 ea.**

(D) **652809P** Spring. 1947-52 & 1959-63 car. Truck: 1949-64 C-Cab & 1960-64 Champ **\$9.50 ea.**

(D) **1314833P** Spring. 1956 to early 1957 car. 1959-64 C & K **\$9.50 ea.**

(H) **1320899** Dovetail. 1957-58 car & 1959-64 C & K **\$16.00 ea.**

(G) **1312669** Rod. hood lock link. 1956-57 C&K **\$22.00 ea.**

(E) **1314152P** Lever with bracket. 1956-57 Hawk. Attaches to rod **\$18.00 ea.**

(L) **1314156** Attaches to Hood latch. 1956-57 C&K **\$18.00 ea.**

(L) **1320087** Lever. 1957 sedan **\$18.00 ea.**

(E) **1326671** Lever, attaches to rod. 1958-61 Hawk **\$20.00 ea.**

(L) **1327026** Lever. 1958 sedan **\$18.50 ea.**

(K) **299079** 1953-54 C & K car. **\$95.00 ea.**

(K) **652502** 1949-64 C-Cab **\$95.00 ea.**

(K) **1312960** 1956 sedan **\$95.00 ea.**

(K) **1326666** 1958-62 C & K-body car **\$140.00 ea.**

(K) **1327025** 1958 sedan **\$95.00 ea.**

(K) **1351370** 1963-64 Hawk **\$140.00 ea.**

HOOD SPRINGS



266584 1941-48 M-Series truck **\$9.50 ea.**

284505P Connects hinge to lower bracket. 1947-60, all models. 1961-64 Hawk. Truck: 1960-64 Champ. Takes 2. **\$9.95 ea.**

308907P Connects hinge to inner fender. 1953-58 all models. 1959-64 Hawk. Takes 2. **\$12.50 ea.**

652143 Connects hinge to inner fender. Truck: 1949-64 C-cab **\$12.50 ea.**

770530 Hood spring kit. All 4 springs for 1953-58 car, all models. 1959-64 Hawk. Includes two 284505P & two 308907P **\$42.50/set 4**

1353929 Return spring hood lock. 1963-66 Lark & 1963-85 Avanti **\$6.25 ea.**

HOOD RELEASE CABLES

Includes handles

293902X5 1959-60 Lark **\$45.00 ea.**

293902X6 Right hand drive, 1959-63 Lark **\$45.00 ea.**

293902X7 1961-63 Lark **\$45.00 ea.**

293902X12 1964-66 Lark **\$45.00 ea.**

HOOD SAFETY CATCHES

1332067 Hook, hood safety catch. 1959-60 Lark. Includes bracket **\$16.50 ea.**

1338242 Hood safety catch. 1961 Lark **\$15.00 ea.**

1338243 Hood safety catch with bracket. 1961-63 Lark **\$18.00 ea.**

1339708 Hood safety catch. 1962-63 Lark **\$12.00 ea.**

1356765 Hook, hood safety catch with bracket. 1964-66 Lark **\$26.00 ea.**

HOOD INSULATORS

NOTE: These fiberglass insulators are cut from original Studebaker patterns. They are glued to the underside of the hood and are intended to keep noise levels low.

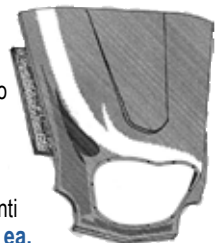

800201 Early 1963 Avanti short style **\$28.15 ea.**

800202 Full insulator. Late 1963 & Early Avanti II **\$35.00 ea.**

800260 1953-64 C & K car including Hawk. **\$31.25 ea.**

800261 1953-63 car, all models except C&K **\$31.25 ea.**

800262 1964-66 Lark **\$27.50 ea.**

800209 For a larger than original insulator we offer the same original type material 47"X54". Easily cut to fit the maximum amount of space under your hood **\$47.50 ea.**

1331828-9 1959-60 Lark. Truck: 1960-64 Champ. NOS **\$45.00 pr.**

1350775 Short style, 1963 Avanti. NOS **\$60.00 ea.**

1358675 1964-66 Lark. NOS **\$60.00 ea.**

HOOD PROP RODS

- 292141** Rod. 1951 car.....\$30.00 ea.
- 296403** Rod. 1952 car.....\$32.00 ea.
- 299754** Rod. 1953-54 C & K.....\$49.99 ea.
- 307954** Rod. 1955 C & K.....\$35.00 ea.
- 308469** Rod. 1955 sedan.....\$35.00 ea.
- 1314089** Rod. 1956-64 C & K.....\$40.00 ea.
- 1337064** Rod. late 1959-60 Lark. Truck:
1960-64 Champ.....\$25.00 ea.
- 1654135** Rod. Truck: 2E - 6E.....\$35.00 ea.

HOOD PROP RELATED PARTS



- 292143** 1951-54 all except C&K bodies, 1959-60 Lark, retainer clip.....\$4.25 ea.
- 299777** Hood prop retainer clip. 1947-60 car & 1959-64 Hawk.....\$4.00 ea.
- 1336807** Bolt. Secures hood prop to hood & inner fender. 1963 Avanti.....\$5.50 ea.
- 1358708** Bolt. Secures hood prop to hood & inner fender 1964-89 Avanti.....\$5.50 ea.

HOOD FILLERS

Painted moulding on each side of grille.

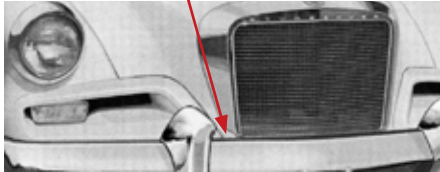

- 1343504** Hood filler, right. 1962 Hawk.....\$20.00 ea.
- 1343505** Hood filler, left. 1962 Hawk.....\$20.00 ea.

GRILLE & LAMP



- 1331840** Right. 1959 Lark. Truck: 1961-64 Champ. Chrome. Choice of clear or amber lens.....\$150.00 ea.
- 1331841** Left. 1959 Lark. Truck: 1961-64 Champ. Chrome. Choice of clear or amber lens.....\$150.00 ea.
- 1336216** Right. 1960 Lark. Truck: 1960 Champ. Chrome.....\$145.00 ea.
- 1336217** Left. 1960 Lark. Truck: 1960 Champ. Chrome.....\$150.00 ea.
- 1655326X1** Right. 1960 Champ truck. Painted. Pictured above.....\$95.00 ea.
- 1655327X1** Left. 1960 Champ truck. Painted.....\$95.00 ea.
- 1656350** Right. 1961-64 Champ truck Painted.....\$95.00 ea.
- 1656351** Left. 1961-64 Champ truck. Painted.....\$95.00 ea.

GRILLE RELATED ITEMS



- 3035X2** Seal, side grille to body. 1963-64 Hawk.....\$6.00 pr.

GRILLES

- 800298** 1971-83 Avanti.....\$324.99 ea.
- 1312844** Right Air scoop. 1956 sedan.....\$25.00 ea.
- 1320376** Center grille. All 1957 sedan & wagon except Scotsman.....\$195.00 ea.

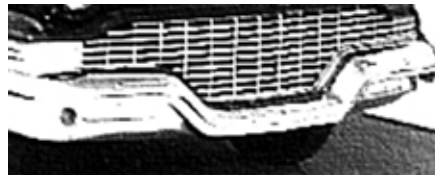
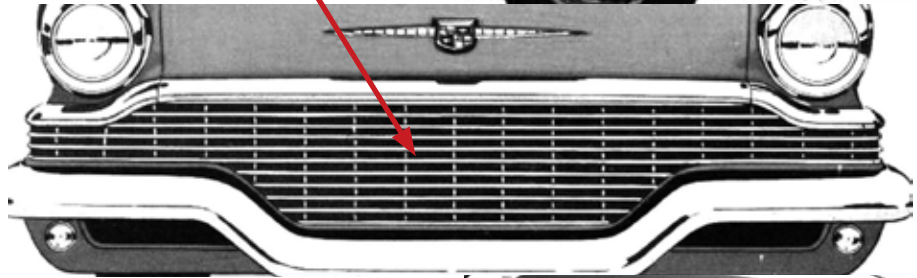

- 1320379** Left side grille. 1957 sedan & wagon.....\$115.00 ea.
- 1323486P** Right side grille. 1957-58 Scotsman.....\$65.00 ea.
- 1323487P** Left side grille. 1957-58 Scotsman.....\$65.00 ea.



- 1323125** Upper grille. 1957 Packard.....\$215.00 ea.
- 1326122** Center grille. 1958 Champion & Commander.....\$225.00 ea.
- 1327010** Right side grille. 1958 Champion & Commander.....\$76.50 ea.
- 1327011** Left side grille. 1958 Champion & Commander.....\$76.50 ea.



- 1327500P** Center grille. 1958 Scotsman sedan & station wagon.....\$150.00 ea.



- 1327543P** Grille. 1958 Packard Hawk.....\$185.00 ea.

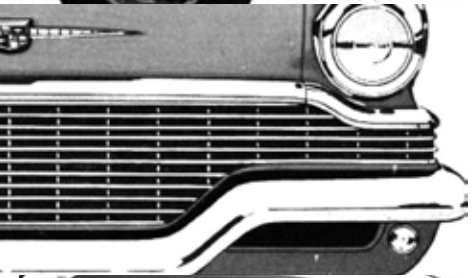

- 1336221W** Mesh. 1960 Lark. Will also substitute for 1959 Lark.....\$85.00 ea.
- **1338235W** Moulding. 1961 Lark.....\$60.00 ea.
- 1338246W** Mesh. 1961 Lark.....\$60.00 ea.
- 1342523W** Mesh. 1962 Lark.....\$75.00 ea.
- **1342524W** Moulding. 1962-63 Lark.....\$60.00 ea.

** Has scratches or other imperfections in chrome. Most blemishes are not noticeable when on the car, but for show quality, new plating is required.

- 1342524WX1** same as above except it's a re-plated NOS item.....\$295.00 ea.
- 1352704W** Mesh. 1963 Lark.....\$75.00 ea.

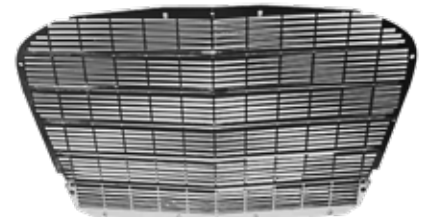

- 1353535W** Mesh. 1963 Hawk. Will fit 1962 & 1964 Hawks also.....\$85.00 ea.
- 1356106** Grille. 1964 Lark with single headlight.....\$95.00 ea.
- 1358783** Grille. 1963-70 Avanti.....\$299.95 ea.
- 1546227** Grille, lower section. 1958 Packard all models except Hawk.....\$120.00 ea.



- 1362106X1** Mesh. 1966 Commander (Takes 4).....\$45.00 ea.
- 1362106X2** Mesh. 1966 Daytona and Cruiser. Like picture except center slats are black with chrome frame. Takes 4.....\$50.00 ea.

1953-55 SEDAN & 1955-64 C & K (front)

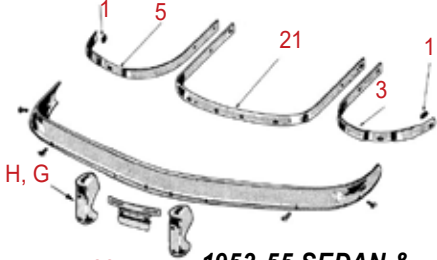

1953-55 SEDAN & 1955-64 C & K (rear)

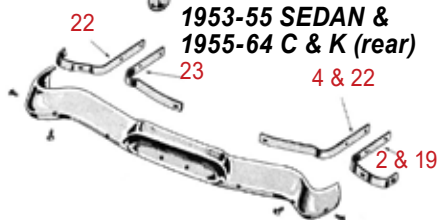

BUMPERS Front

- ***514661** 1942 Commander & President.....
..... **Call for price**
 - ***515021** 1942-46 Champion **Call for price**
 - ***525072** 1950 Commander & Land Cruiser.....
..... **Call for price**
 - ***1543503** Upper outer. All 1957 Packard.....
..... **Call for price**
 - ***1543504** Lower outer. All 1957 Packard.....
..... **Call for price**
 - B. ***1550725W** All 1961 Lark..... **\$300.00 ea.**
 - 1556190** Center 1963-85 Avanti with metal
bumpers..... **\$950.00 ea.**
 - 1556191** Right or left 1963-85 Avanti with metal
bumpers..... **\$675.00 ea.**
 - 1657064** Postal Zip Van **\$200.00 ea.**
 - 1692246P** 1960-64 T-cab pickup .. **\$150.00 ea.**
- OTHERS ARE AVAILABLE, PLEASE INQUIRE.

BUMPERS Rear

- ***1547820W** 1959-61 Lark station wagon.....
..... **\$300.00 ea.**
- D. ***1550726W** 1961 Lark except station wagon
..... **\$300.00 ea.**
- E. ***1560774W** 1964-66 Lark..... **\$300.00 ea.**
- 1556200** 1963-64 Avanti. Rear
bumper **\$1,550.00 ea.**

- E. **1560774X1** 1964-66 Lark. NOS with new
chrome plating. Nice!..... **\$445.00 ea.**
- OTHERS ARE AVAILABLE, PLEASE INQUIRE.

BUMPER BOLTS

- 527972** Rectangular head.
1947-66 most models. Stainless
head..... **\$8.25 ea.**
- 524972x1** With nut & washer..... **\$9.25/set**
- 1541696** Round head. 1956-64 many models.
Stainless head. Includes nut..... **\$2.50 ea.**

BUMPER EXTENSIONS

- 1539124-5W** 1956 Sedan bumper end.....
..... **\$145.00 pr.**



M&N

- 1555098-9W**
1962-63. Extension for
front or rear bumper.
..... **\$45.00 pr.**

1956 SEDAN (front)

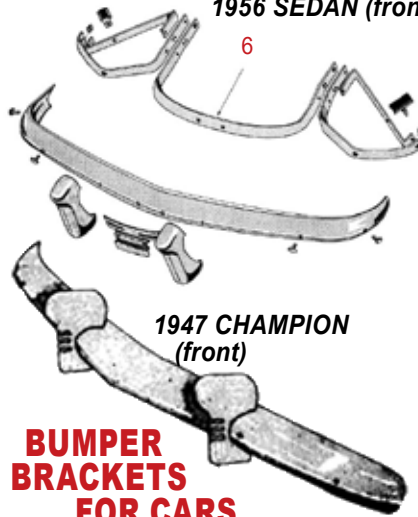

1947 CHAMPION (front)

BUMPER BRACKETS FOR CARS

- 1. **518494** Spacer..... **\$2.50 ea.**
- 3. **535971P** Front outer left. 1955 sedan.....
..... **\$65.00 ea.**
- 4. **536100P** Rear inner right. 1955-57 C & K.....
..... **\$55.00 ea.**
- 5. **536136P** Front outer right. 1955 C & K.....
..... **\$70.00 ea.**
- 6. **1539416P** Front, inner. 1956 sedan.....
..... **\$80.00 ea.**
- 7. **1541677P** Front left. 1957-58 sedan. Hardtop
..... **\$40.00 ea.**
- 8. **1541708P** Rear inner right. 1957 sedan &
1957 Packard station wagon..... **\$43.00 ea.**
- 9. **1541709P** Rear inner left. 1957 sedan &
1957 Packard station wagon..... **\$43.00 ea.**
- 10. **1541710P** Rear outer right. 1957 sedan &
1957 Packard station wagon..... **\$67.00 ea.**
- 11. **1541711P** Rear outer left. 1957 sedan &
1957 Packard station wagon..... **\$67.00 ea.**
- 12. **1544688P** Rear outer right. 1958 sedan &
1958 Packard station wagon..... **\$67.00 ea.**
- 13. **1547204P** Front right. 1959-60 Lark.....
..... **\$37.00 ea.**
- 14. **1547205P** Front left. 1959-60 Lark.....
..... **\$37.00 ea.**
- 15. **1547216P** Rear right. 1959-60 Lark.....
..... **\$37.00 ea.**
- 16. **1547218P** Front & rear. 1959-61 Lark.....
..... **\$27.00 ea.**
- 17. **1550692P** Front right. 1961 Lark.....
..... **\$37.00 ea.**
- 18. **1550693P** Front left. 1961 Lark.....
..... **\$37.00 ea.**
- 19. **1552860P** Rear outer right. 1962-64 Hawk..
..... **\$50.00 ea.**
- 20. **1552861P** Rear outer left. 1962-64 Hawk....
..... **\$50.00 ea.**
- 21. **1552870P** Front inner. 1959-64 Hawk.....
..... **\$100.00 ea.**
- 22. **1552886** Rear inner right. 1962-64 Hawk.....
..... **\$55.00 ea.**
- 23. **1552887** Rear inner left. 1962-64 Hawk.....
..... **\$55.00 ea.**
- 1554296** Front right. 1962-63 Lark.. **\$60.00 ea.**
- 24. **1554297P** Front left. 1962-63 Lark.....
..... **\$50.00 ea.**

1957-58 SEDAN (front)

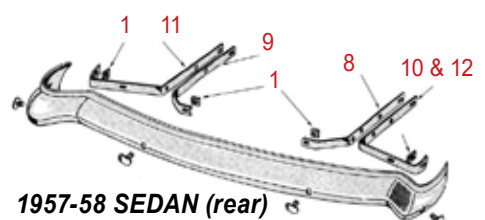
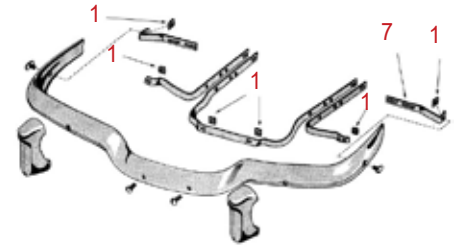

1957-58 SEDAN (rear)

- 25. **1554306P** Rear right. 1962-63 Lark.....
..... **\$37.00 ea.**
- 26. **1554307P** Rear left. 1962-63 Lark.....
..... **\$37.00 ea.**
- 27. **1555154P** Front & rear. 1962-66 Lark.....
..... **\$30.00 ea.**
- 28. **1560677P** Rear left. 1964-66 Lark.....
..... **\$37.00 ea.**
- 29. **1562340P** Front, left & right. 1964-66 Lark .
..... **\$50.00 ea.**

1959-61 LARK front

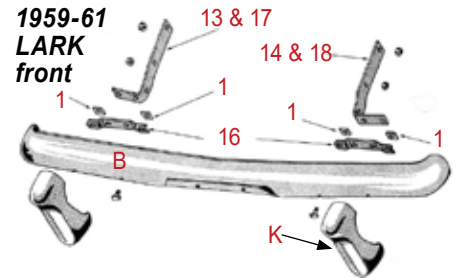

1959-61 LARK rear

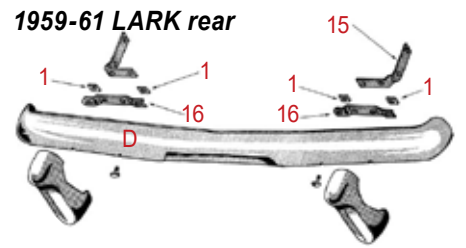

1964-66 LARK front

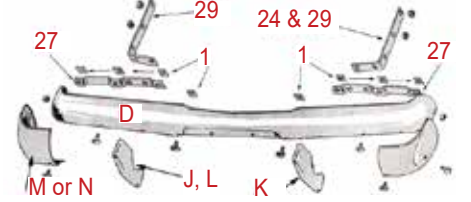

1964-66 LARK rear

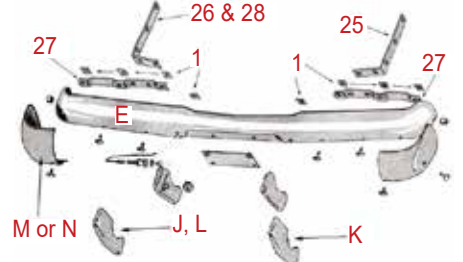

* Please Note: These bumpers are original chrome plating and are NOT considered show quality.

BUMPER BRACKETS FOR TRUCK

- 682738P** Front bumper bar brace to frame, left & right. 3E-6E 13, 14, 16, 17, 28, 38, 40. 7E-8E 13, 15, 25, 28, 35, 40, 45..... **\$30.00 ea.**
- 1692059P** Front gusset, bumper to frame. 5E-6E 5, 6, 7, 10, 11, 12. 7E 5, 7, 10, 12..... **\$17.50 ea.**
- 1692247P** Bracket, front bumper to frame, left & right.. 5E-6E 5, 6, 7, 10, 11, 12. 7E-8E 5, 7, 10, 12..... **\$14.00 ea.**
- 1693788** Rear right. 6E-8E 5, 7, 10, 12..... **\$27.00 ea.**
- 1693789** Rear left. 6E-8E 5, 7, 10, 12..... **\$27.00 ea.**
- 1694440** Front gusset, bumper to frame. 8E 5, 7, 10, 12..... **\$17.50 ea.**
- 1695368** Front right bumper to frame. 7E-8E 28, 35, 40, 45..... **\$21.00 ea.**
- 1695369** Front left bumper to frame. 7E-8E 28, 35, 40, 45..... **\$21.00 ea.**

TRUCK MODELS 5-6-7-10-11-12 front 3 & 7

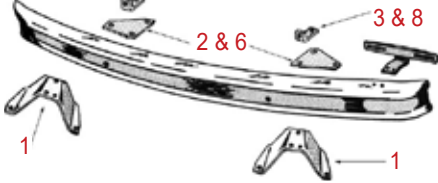

TRUCK MODELS 5-6-7-10-11-12 rear

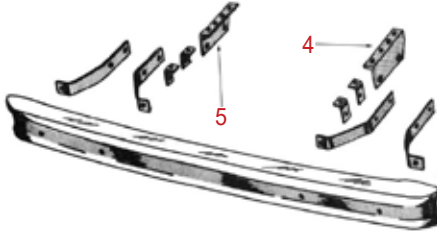

REAR BUMPER LICENSE PLATE GUARDS

- *532043W** All 1953-54 models & 1956 -57 station wagon..... **\$145.00 ea.**
- *1547812W** 1959-61 station wagon, license & guard assembly..... **\$125.00 ea.**
- *1554304W** 1962-63 car, license guards, right. Pictured..... **\$40.00 ea.**
- *1554305W** 1962-63 car, license guards, left. Pictured..... **\$40.00 ea.**
- *1562868W** 1964-66, all models, rear license guard right..... **\$40.00 ea.**
- *1562869W** 1964-66, all models, rear license guard left..... **\$40.00 ea.**



BUMPER BAR GROMMET

- 648258** 1936-40 All. Rear. 1941-48 Truck. Front. 1941-48 car..... **\$20.00 ea.**



BUMPER GUARDS

- AC-2855** Front bumper guard kit. 1957-58 all cars except Hawk. See opposite page, upper right corner..... **\$75.00 pr.**
 - K & L AC-3516** Front or rear bumper guard kit. 1962-66 car. Except C & K..... **\$80.00 pr.**
 - 524885** Right front or left rear. 1949-50 Commander..... **\$75.00 ea.**
 - G. 532032** Right front. All 1953 sedan..... **\$124.75 ea.**
 - G. 532033** Left front. All 1953 sedan..... **\$124.75 ea.**
 - H. 534720** Right front. All 1954..... **\$85.00 ea.**
 - 801835** Rear bumper guard set, all 1947 Champion and Commander models. Set contains one pair, 519029 and 519030..... **\$120.00 pr.**
 - I. 1539033W** Left front. 1956-64 Hawk..... **\$119.75 ea.**
 - 1539910-1W** 1956 Sedan rear bumper guard..... **\$145.00 pr.**
 - J. 1562580W** Right front or left rear. 1964-66 Lark. Also contained in AC-3516 kit..... **\$40.00 ea.**
 - K. 1554884W** Left front, right rear. 1962-66 Lark. Also contained in AC-3516 kit..... **\$40.00 ea.**
 - L. 1554885W** Right front, Left rear, 1962-63 Lark. Also contained in AC-3516 Kit..... **\$40.00 ea.**
- Other Bumper Guards are available. If you don't see what you need, please call (317) 462-3124 and inquire.*

FRONT BUMPER PARTS

1963-83 Avanti

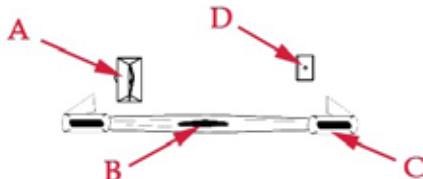

- (A) **1350045** Grommet, bumper bracket to body. 1963-85..... **\$22.00 ea.**
- (B) **1555923** Rubber cushion, center. 1963-83..... **\$55.00 ea.**
- (C) **1555924** Rubber cushion, end. 1963-83..... **\$40.00 ea.**
- (D) **1556198** Rubber shim, bumper end to body 1/8" 1963-83..... **\$3.00 ea.**
- (D) **1556199** Rubber shim, bumper end to body 1/4" 1963-83..... **\$3.00 ea.**

REAR BUMPER PARTS

1963-83 Avanti

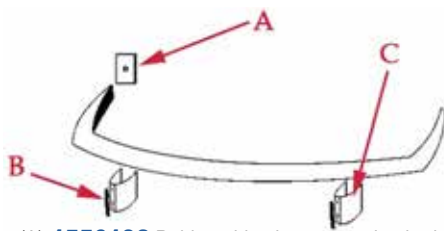

- (A) **1556198** Rubber shim, bumper end to body 1/8". 1963-83..... **\$3.00 ea.**
- (A) **1556199** Rubber shim, bumper end to body 1/4". 1963-83..... **\$3.00 ea.**
- (B) **1555925** Rubber cushion, vertical bumper. 1963-85..... **\$40.00 ea.**
- (C) **1556201** 1963-64 Avanti. Rear vertical bumperette..... **\$195.00 ea.**

LICENSE BRACKETS & RELATED PARTS

- 3183X1** Secures rear license bracket to body. 1963-85 Avanti..... **\$3.50 ea.**
- 256410** Rear bracket. Truck: 1937-64. All with narrow bed. 1937-39 Coupe Express..... **\$40.00 ea.**
- 293071P** Rear bracket. 1951-52 all..... **\$35.00 ea.**
- 801083** Front bracket. 1963-83 Avanti license plate bracket. Replaces center rubber pad..... **\$40.00 ea.**
- 1331803** Seals rear license plate to body. 1959-61 Lark. Takes 4..... **\$3.50 ea.**
- 1542713P** Front bracket. 1957 sedan..... **\$25.00 ea.**



- 1350230** Stainless rear bracket. 1963-83 Avanti..... **\$80.55 ea.**

1544815

- 1544815** Front bracket. 1950-56 all, 1957-64 C&K includes Hawk..... **\$45.00 ea.**

- 1546130** Front bracket. 1958 sedan & J - hardtop..... **\$25.00 ea.**

1554303

- 1554303** Front bracket. 1959-66 Lark. Rear. 1962-66 Lark..... **\$25.00 ea.**

1695407

- 1695407** Front bracket. Truck: Most Models..... **\$30.00 ea.**

FIREWALL GROMMETS

131026 1934-42 cars, headlight cables. 1947-49 Champ & Commander, parking lights, headlights, fog lights. 1951-52 car, headlights and horn to relay cable. 1953-54 car, parking lights. 1953-64 Hawk and coupe, headlights. 1955-57 car, headlights to fender apron. 1955 car, parking lights. Truck: 1941-48 M-Series. 1949-56, chassis harness, horns, taillights, headlights.....
.....\$4.00 ea.



195802 Main wiring harness. 1939-52 all models...\$6.10 ea.

195803 Retainer for 195802 and 523232 grommets.....\$12.50 ea.



293762 Heater cable, wiper motor, 1951-52 cars. Oil pressure line, 1953-54 cars. Hawk oil hose, 1953-64 cars. Horn cable, 1956-58 cars. Electric wiper cable, 1959-60 cars.....
.....\$3.50 ea.



523232 Speedometer shaft. 1947-51 car.\$7.50 ea.



532855 Head light cable to front fender. 1953-54 O/D cables to dash.....\$4.00 ea.

532857 Speedometer cable. 1953-58 car.....
..... use 1548474



532909 Main wiring harness. 1953-55 car, all models.\$8.00 ea.

1351088 Air duct cable, 1959-60 cars. Hood cable, 1959-60 cars. Heater cable, water control valve cable, 1959-61 cars. Hood release cable and various other single wire applications. 1959-66 car all models & 1963-85 Avanti.....\$3.00 ea.



1540836 Main wiring harness. 1956-66 car, all models. 1963-85 Avanti. Truck: 1960-64 Champ. Hood control cable, 1961 car.....
.....\$8.00 ea.

1548474 Speedometer cable. 1959-66 car, all models. Truck: 1960-64 Champ. Avanti 1963-85.....
.....\$8.00 ea.



I finally found the part I was searching for at Studebaker International!

Now I know to call them first!

317-462-3124

TRUCK HITCH



954301 Truck hitch, various years and models. Limited quantity available
.....\$99.95 ea.

DOOR VENT SHADES

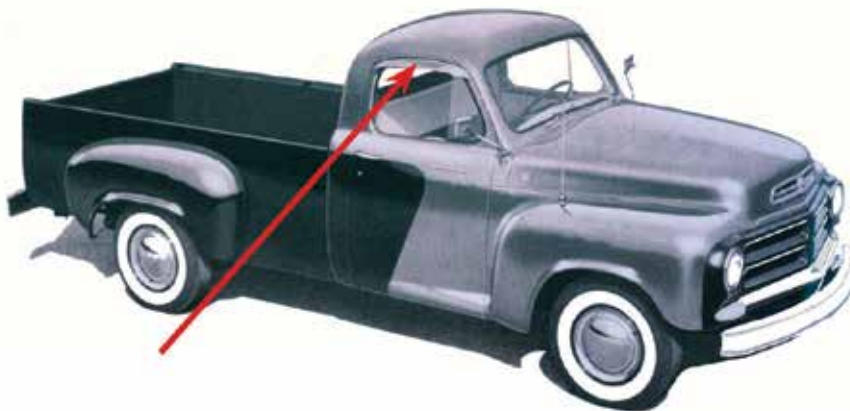

802344 For all 1949-64 C-cab trucks. Includes attaching screws and template for drilling mounting holes. Excellent quality, ready to paint.....\$125.00 pr.

CAR & TRUCK COVERS



Protect your car from the elements with this top quality car cover. Suitable for inside or outside use. Water resistant cotton poly blend. Custom fit, available for most years and models of Studebaker. Inquire

at 317-462-3124 if you don't see your model listed here. Specify year and model when ordering.

800185X2 1953-64. C & K includes Hawk.....\$412.50 ea.

800185X3 1959-66 Lark and all Avanti\$349.95 ea.

800185X4 1947-58 sedan.....\$412.50 ea.

COWL DRAIN TUBE & STRAP

1339718 Drain tube mounting strap.....
.....\$2.25 ea.



1352488 Cowl drain tube. 1963-66 Lark. Mounts on firewall. (Includes mounting strap).....\$35.00 ea.

DUMDUM SEALER

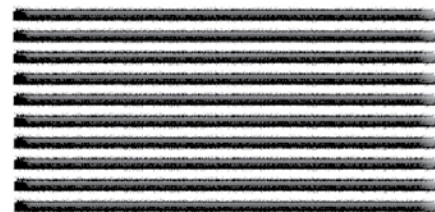

801920 Studebaker used lots of DumDum in their cars and trucks. It was used to seal body panels, fill holes in the firewall and floor pan, and seal around hoses passing through the firewall, etc. This is a 3M product that is black and has the texture of soft clay. It is very pliable and useful to seal any hole. One package includes 10 beads that are approximately one foot long and about 1/8" in diameter 4.0 oz.\$6.95 ea.

MOULDING CLIP KITS



Kits Save Money!

COWL DRAIN KIT

Kit includes:
 Drain chamber • Drain tube
 Hose coupling
 Hose clip • Mounting clips

1339709 1961-62 Lark.....**\$95.00 ea.**

INDIVIDUAL MOULDING CLIPS AND SCREWS

1093X54 T-head screw for inner fin Moulding. 1956-61 Hawk with fins..... **\$1.50 ea.**



1321146 Clip for chrome cowl Moulding. 1956-64 Hawk. Use with 295918 seal..... **\$3.50 ea.**



1458X12 Belt Moulding clip. 1957-61 Hawk. Takes 8..... **\$1.50 ea.**



296514G Clip. Top of door and rear quarter cast Moulding. All 1953 and early 1954 cars with snap-type clip on back of Moulding..... **\$2.00 ea.**



Studebaker Gift Certificates

Always a Great Idea!

Available in any Amount!

No Expiration Date!

1955 Champion or Commander 2-Door Sedan



307213 (14)**\$1.50 ea.**

Total of all parts listed if purchased separately.**\$21.00**

801859 Kit price.....**\$18.50 kit.**

1955 Champion or Commander 4-Door Sedan

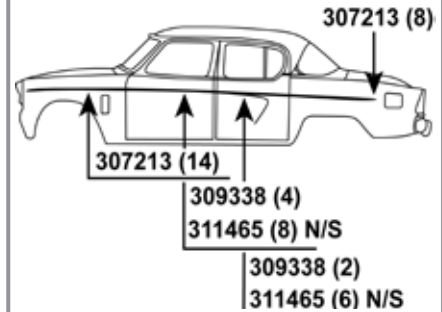

307213 (20)**\$1.50 ea.**

309338 (6)**\$2.50 ea.**

Total of all parts listed if purchased separately.**\$45.00**

801860 Kit price**\$40.00 kit.**

1955 Commander, President or President State 4-Door Sedan

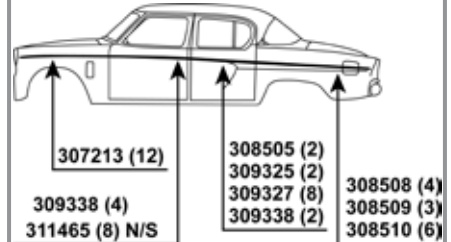

307213 (12)**\$1.50 ea.**

308505 (2)**\$2.00 ea.**

308508 (4)**\$3.00 ea.**

308509 (3)**\$2.00 ea.**

308510 (6)**\$3.50 ea.**

309325 (2)**\$6.00 ea.**

309327 (8)**\$2.50 ea.**

309338 (6)**\$2.50 ea.**

Total of all parts listed if purchased separately.**\$108.00**

801861 Kit price.....**\$98.00 kit.**

1955 Champion, Commander or President 2-Door Coupe

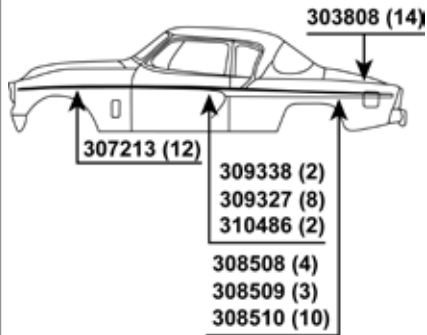

- 303808 (14)\$2.95 ea.
- 307213 (12)\$1.50 ea.
- 308508 (4)\$3.00 ea.
- 308509 (3)\$3.00 ea.
- 308510 (10)\$3.50 ea.
- 309327 (8)\$2.50 ea.
- 309338 (2)\$2.50 ea.
- 310486 (2)\$3.50 ea.

Total of all parts listed if purchased separately.\$147.30

801862 Kit price..... \$135.00 kit.

1955 Champion, Commander, President Hardtop or Speedster 2-Door

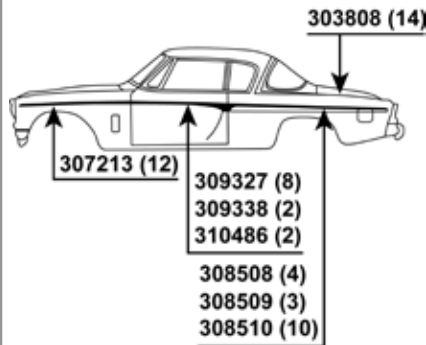

- 303808 (14)\$2.95 ea.
- 307213 (12)\$1.50 ea.
- 308508 (4)\$3.00 ea.
- 308509 (3)\$2.00 ea.
- 308510 (10)\$3.50 ea.
- 309327 (8)\$2.50 ea.
- 309338 (2)\$2.50 ea.
- 310486 (2)\$3.50 ea.

Total of all parts listed if purchased separately.\$147.30

801863 Kit price..... \$130.00 kit.

1956 President 2-Door Sedan

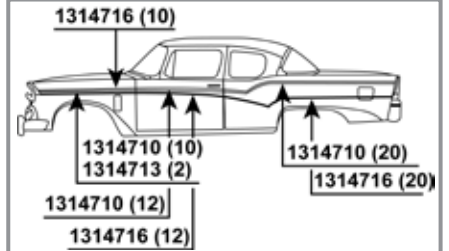

- 1314710 (42)\$2.25 ea.
- 1314713 (2)\$2.00 ea.
- 1314716 (42)\$2.00 ea.

Total of all parts listed if purchased separately.\$182.50

801866 Kit price..... \$155.00 kit.

1956 President, or President Classic 4-Door Sedan

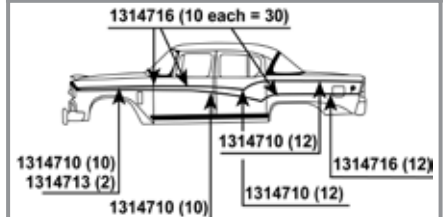

- 1314710 (44)\$2.25 ea.
- 1314713 (2)\$2.00 ea.
- 1314716 (42)\$2.00 ea.

Total of all parts listed if purchased separately.\$176.00

801867 Kit price..... \$158.00 kit.

1956 Champion or Commander 2-Door Sedan

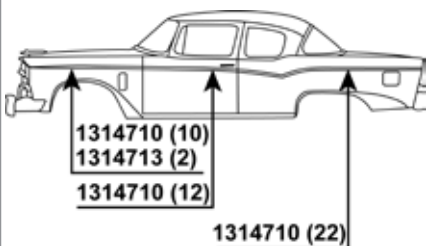

- 1314710 (44)\$2.25 ea.
- 1314713 (2)\$2.00 ea.

Total of all parts listed if purchased separately.\$92.00

801864 Kit price..... \$82.00 kit.

1956 Champion or Commander 4-Door Sedan

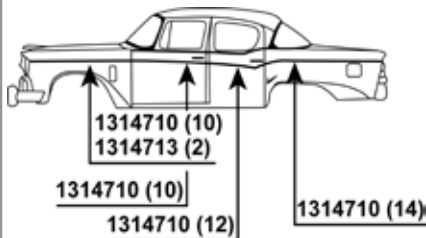

- 1314710 (46)\$2.25 ea.
- 1314713 (2)\$2.00 ea.

Total of all parts listed if purchased separately.\$96.00

801865 Kit price..... \$86.00 kit.

1956 Flight, Power or Sky Hawk

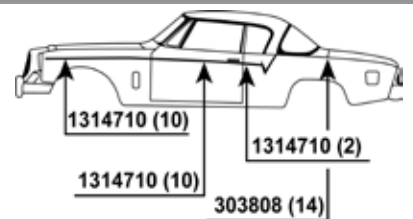

- 303808 (14)\$2.95 ea.
- 1314710 (22)\$2.25 ea.

Total of all parts listed if purchased separately.\$85.30

801868 Kit price..... \$76.00 kit.

1956 Golden Hawk

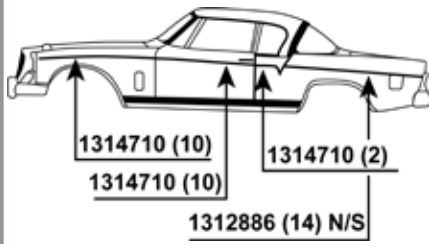

1314710 (22)\$2.25 ea.

Total of all parts listed if purchased separately.**\$44.00**

801869 Kit price**\$40.00 kit.**

**1957 President
2-Door Sedan**

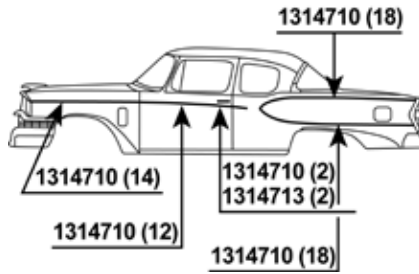

1314710 (62)\$2.25 ea.

1314713 (2)\$2.00 ea.

Total of all parts listed if purchased separately.**\$128.00**

801872 Kit price **\$115.00 kit.**

1957-58 Golden Hawk

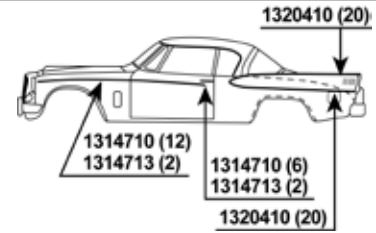

1314710 (18)\$2.25 ea.

1314713 (4)\$2.00 ea.

1320410 (40)\$2.00 ea.

Total of all parts listed if purchased separately.**\$124.00**

801875 Kit price **\$112.00 kit.**

**1957 Champion or
Commander
2-Door Sedan**

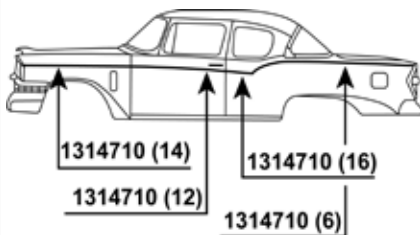

1314710 (48)\$2.25 ea.

Total of all parts listed if purchased separately.**\$96.00**

801870 Kit price **\$86.00 kit.**

**1957 President Classic
4-Door Sedan**

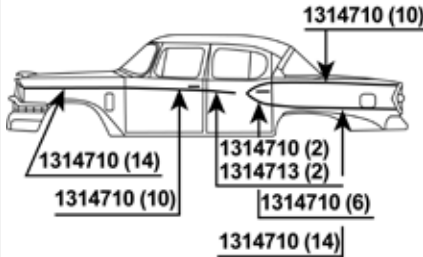

1314710 (56)\$2.25 ea.

1314713 (2)\$2.00 ea.

Total of all parts listed if purchased separately.**\$116.00**

801873 Kit price **\$104.00 kit.**

**1958 Champion
or Commander
2-Door Sedan**

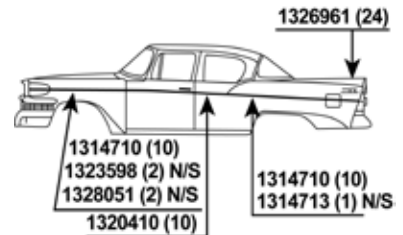

1314710 (30)\$2.25 ea.

1326961 (24)\$2.00 ea.

Total of all parts listed if purchased separately.**\$108.00**

801876 Kit price **\$97.00 kit.**

**1957 Champion or
Commander
4-Door Sedan**

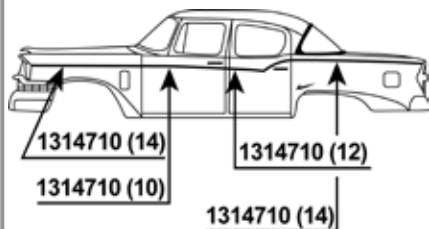

1314710 (50)\$2.25 ea.

Total of all parts listed if purchased separately.**\$100.00**

801871 Kit price **\$90.00 kit.**

**1957-58 Silver Hawk
2-Door Coupe**

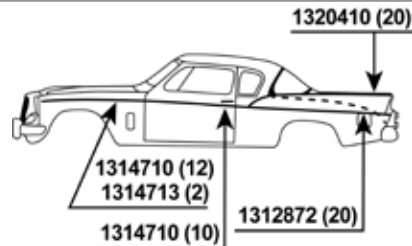

1312872 (20)\$2.00 ea.

1314710 (22)\$2.25 ea.

1314713 (2)\$2.00 ea.

1320410 (20)\$2.00 ea.

Total of all parts listed if purchased separately.**\$128.00**

801874 Kit price **\$115.00 kit.**

**1958 Champion or
Commander
4-Door Sedan**

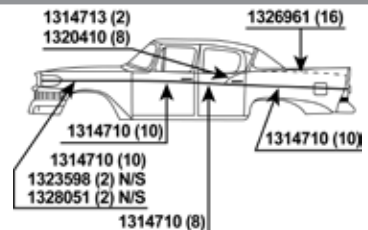

1314710 (38)\$2.25 ea.

1314713 (2)\$2.00 ea.

1320410 (8)\$2.00 ea.

1326961 (16)\$2.00 ea.

Total of all parts listed if purchased separately.**\$128.00**

801877 Kit price **\$115.00 kit.**

1958 Commander 2-Door Hardtop

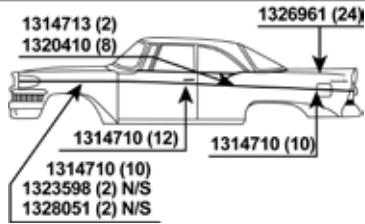

1314710 (32)\$2.25 ea.

1314713 (2)\$2.00 ea.

1320410 (8)\$2.00 ea.

1326961 (24)\$2.00 ea.

Total of all parts listed if purchased separately.\$132.00

801878 Kit price.....\$120.00 kit.

1959-60 Lark 2-Door Sedan

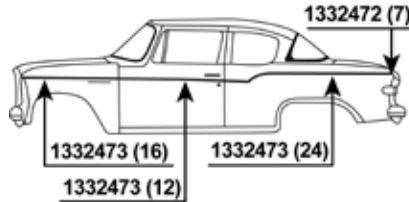

1332472 (7)\$2.25 ea.

1332473 (52)\$2.00 ea.

Total of all parts listed if purchased separately.\$119.75

801881 Kit price.....\$107.00 kit.

1959-60 Lark 2-Door Station Wagon

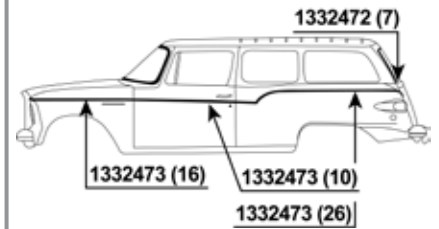

1332472 (7)\$2.25 ea.

1332473 (52)\$2.00 ea.

Total of all parts listed if purchased separately.\$119.00

801884 Kit price.....\$107.00 kit.

1958 President 4-Door Sedan

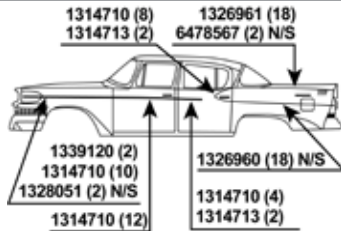

1314710 (32)\$2.25 ea.

1314713 (4)\$2.00 ea.

1339120 (2)\$2.00 ea.

1326961 (18)\$2.00 ea.

Total of all parts listed if purchased separately.\$112.00

801879 Kit price.....\$100.00 kit.

1959-60 Lark 4-Door Sedan

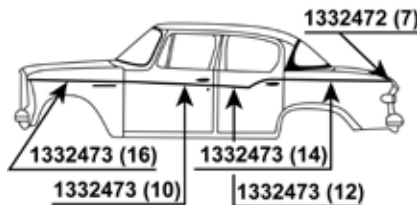

1332472 (7)\$2.25 ea.

1332473 (52)\$2.00 ea.

Total of all parts listed if purchased separately.\$119.75

801882 Kit price.....\$107.00 kit.

1959-60 Hawk 2-Door Coupe

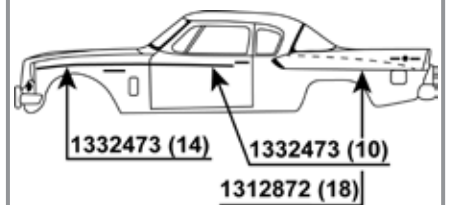

1312872 (18)\$2.00 ea.

1332473 (24)\$2.00 ea.

Total of all parts listed if purchased separately.\$88.50

801885 Kit price.....\$80.00 kit.

1958 President 2-Door Hardtop

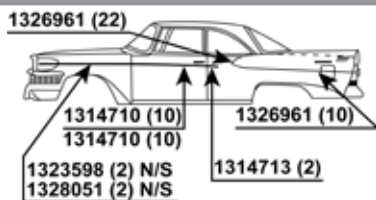

1314710 (22)\$2.25 ea.

1314713 (2)\$2.00 ea.

1326961 (32)\$2.00 ea.

Total of all parts listed if purchased separately.\$112.00

801880 Kit price.....\$100.00 kit.

1959-60 Lark 2-Door Hardtop

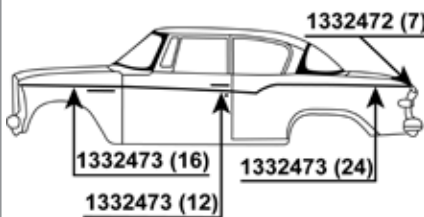

1332472 (7)\$2.25 ea.

1332473 (52)\$2.00 ea.

Total of all parts listed if purchased separately.\$119.75

801883 Kit price.....\$107.00 kit.

1960 Lark 4-Door Station Wagon

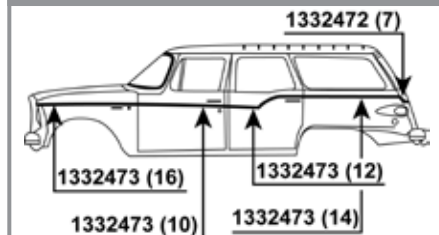

1332472 (7)\$2.25 ea.

1332473 (52)\$2.00 ea.

Total of all parts listed if purchased separately.\$119.95

801886 Kit price.....\$107.00 kit.

**1960 Lark
2-Door Convertible**

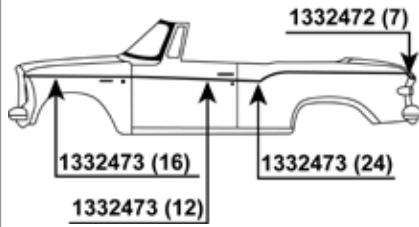

1332472 (7)\$2.25 ea.

1332473 (52)\$2.00 ea.

Total of all parts listed if purchased separately.**\$119.75**

801887 Kit price..... \$107.00 kit.

**1961 Lark
2-Door Hardtop**

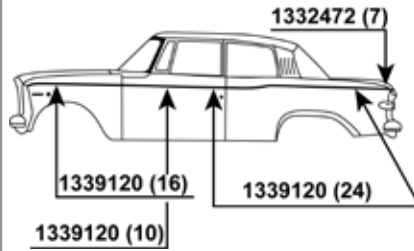

1332472 (7)\$2.25 ea.

1339120 (50)\$2.00 ea.

Total of all parts listed if purchased separately.**\$115.75**

801890 Kit price..... \$104.00 kit.

**1961 Lark
4-Door Station Wagon**

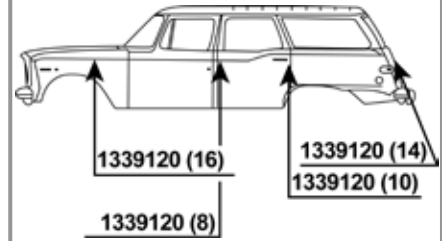

1339120 (48)\$2.00 ea.

Total of all parts listed if purchased separately.**\$96.00**

801893 Kit price..... \$86.00 kit.

**1961 Lark
2-Door Sedan**

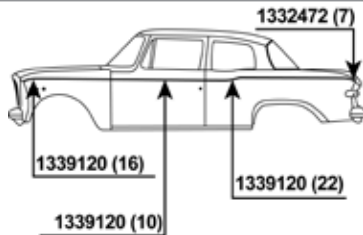

1332472 (7)\$2.25 ea.

1339120 (48)\$2.00 ea.

Total of all parts listed if purchased separately.**\$111.75**

801888 Kit price..... 100.00 kit.

**1961 Lark or Cuiser
4-Door Sedan**

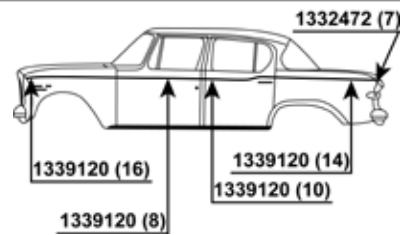

1332472 (7)\$2.25 ea.

1339120 (48)\$2.00 ea.

Total of all parts listed if purchased separately.**\$111.75**

801891 Kit price..... \$100.00 kit.

**1961 Lark
2-Door Convertible**

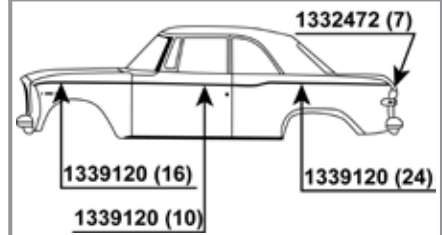

1332472 (7)\$2.25 ea.

1339120 (50)\$2.00 ea.

Total of all parts listed if purchased separately.**\$115.75**

801894 Kit price..... \$104.00 kit.

**1961 Lark
4-Door Sedan**

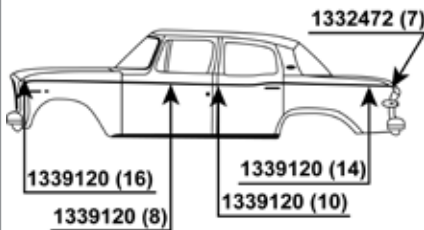

1332472 (7)\$2.25 ea.

1339120 (48)\$2.00 ea.

Total of all parts listed if purchased separately.**\$111.75**

801889 Kit price..... \$100.00 kit.

**1961 Lark
2-Door Station Wagon**

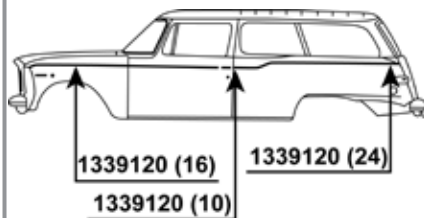

1339120 (50)\$2.00 ea.

Total of all parts listed if purchased separately.**\$100.00**

801892 Kit price..... \$90.00 kit.

**1961 Hawk
2-Door Coupe**

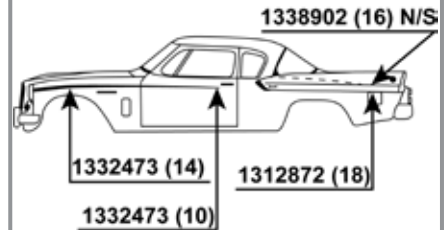

1312872 (18)\$2.00 ea.

1332473 (24)\$2.00 ea.

Total of all parts listed if purchased separately.**\$88.90**

801895 Kit price..... \$80.00 kit.

1962 Lark 2-Door Sedan

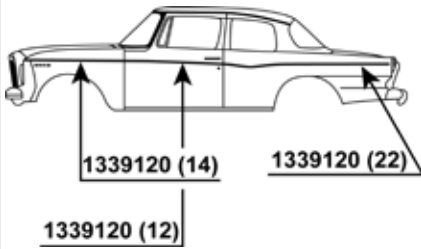

1339120 (48)\$2.00 ea.

Total of all parts listed if purchased separately.**\$96.00**

801896 Kit price.....**\$86.00 kit.**

1962 Lark 4-Door Station Wagon

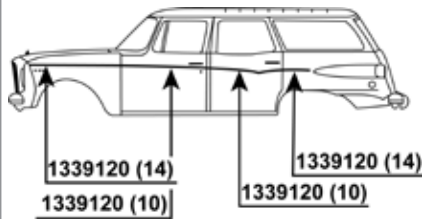

1339120 (48)\$2.00 ea.

Total of all parts listed if purchased separately.**\$96.00**

801899 Kit price.....**\$86.00 kit.**

1963 Lark 2-Door Sedan

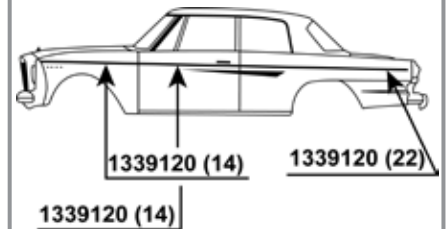

1339120 (50)\$2.00 ea.

Total of all parts listed if purchased separately.**\$100.00**

801902 Kit price.....**\$90.00 kit.**

1962 Lark or Cruiser 4-Door Sedan

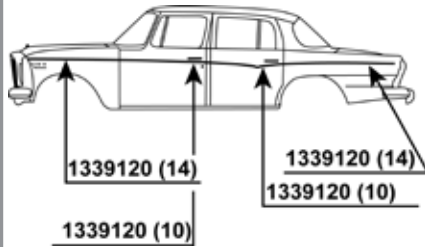

1339120 (48)\$2.00 ea.

Total of all parts listed if purchased separately.**\$96.00**

801897 Kit price.....**\$86.00 kit.**

1962 Lark 2-Door Convertible

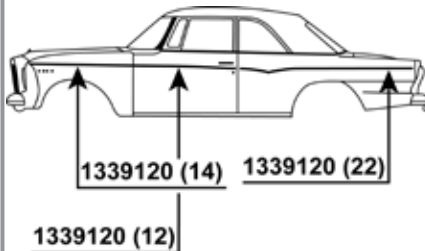

1339120 (48)\$2.00 ea.

Total of all parts listed if purchased separately.**\$96.00**

801900 Kit price.....**\$86.00 kit.**

1963 Lark or Cruiser 4-Door

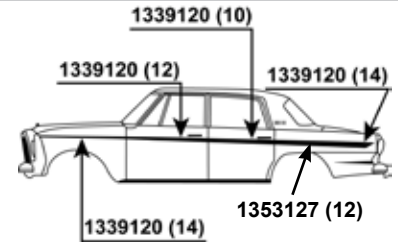

1339120 (50)\$2.00 ea.

1353127 (12)\$1.25 ea.

Total of all parts listed if purchased separately.**\$118.00**

801903 Kit price.....**\$106.00 kit.**

1962 Lark 2-Door Hardtop

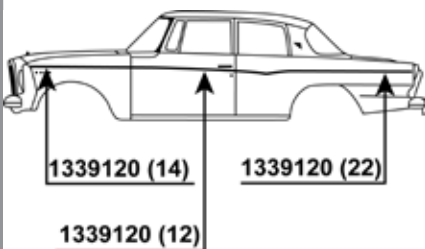

1339120 (48)\$2.00 ea.

Total of all parts listed if purchased separately.**\$96.00**

801898 Kit price.....**\$86.00 kit.**

1962-64 Gran Turismo Hawk

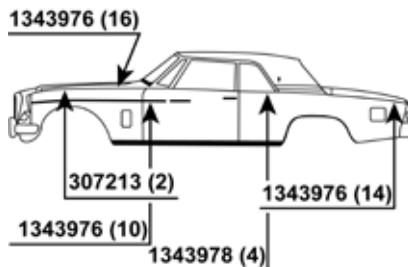

307213 (2)\$1.50 ea.

1343976 (36)\$2.00 ea.

1343978 (4)\$3.50 ea.

Total of all parts listed if purchased separately.**\$89.00**

801901 Kit price.....**\$80.00 kit.**

1963 Daytona 2-Door Hardtop

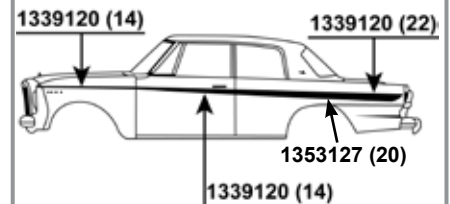

1339120 (50)\$2.00 ea.

1353127 (20)\$1.25 ea.

Total of all parts listed if purchased separately.**\$130.00**

801904 Kit price.....**\$117.00 kit.**

**1963 Lark
4-Door Station Wagon**

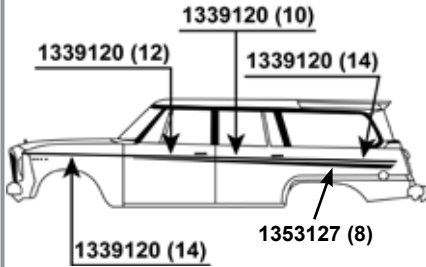

1339120 (50)\$2.00 ea.

1353127 (8)\$1.25 ea.

Total of all parts listed if purchased separately.\$112.00

801905 Kit price.....\$101.00 kit.

**1964-65 Commander
4-Door Sedan or
Station Wagon**

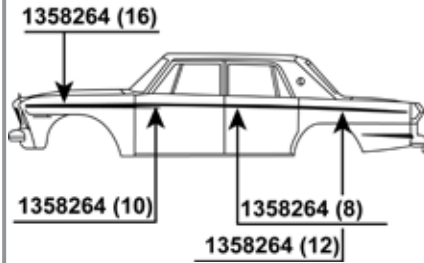

1358264 (46)\$2.00 ea.

Total of all parts listed if purchased separately.\$92.00

801908 Kit price.....\$83.00 kit.

**1964-65 Daytona
4-Door Station Wagon**

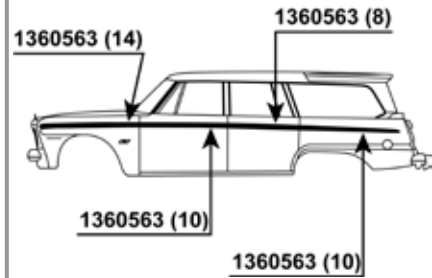

1360563 (42)\$2.50 ea.

Total of all parts listed if purchased separately.\$105.00

801911 Kit price.....\$94.00 kit.

**1963 Daytona
Convertibles**

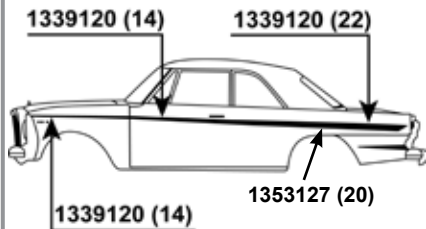

1339120 (50)\$2.00 ea.

1353127 (20)\$1.25 ea.

Total of all parts listed if purchased separately.\$130.00

801906 Kit price.....\$117.00 kit.

**1964-65 Daytona or Cruiser
4-Door Sedan**

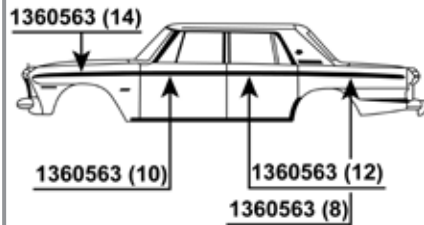

1360563 (44)\$2.50 ea.

Total of all parts listed if purchased separately.\$110.00

801909 Kit price.....\$99.00 kit.

**1964 Daytona
Convertible**

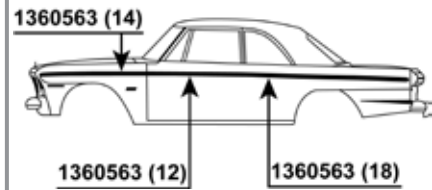

1360563 (44)\$2.50 ea.

Total of all parts listed if purchased separately.\$110.00

801912 Kit price.....\$99.00 kit.

**1964 Challenger or 1964-65
Commander
2-Door Sedan**

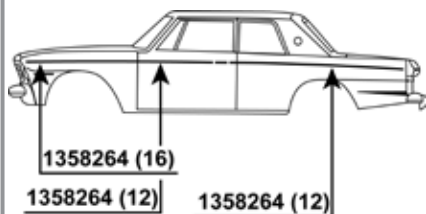

1358264 (40)\$2.00 ea.

Total of all parts listed if purchased separately.\$80.00

801907 Kit price.....\$72.00 kit.

**1964-65 Daytona
2-Door Hardtop**

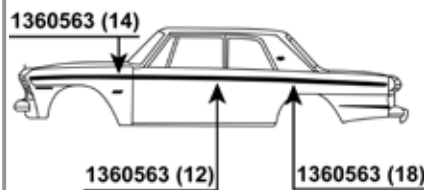

1360563 (44)\$2.50 ea.

Total of all parts listed if purchased separately.\$110.00

801910 Kit price.....\$99.00 kit.

**1966 Commander
2-Door**

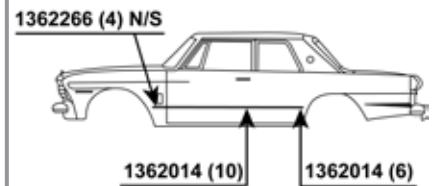

1362014 (16) Substitute 1358264.\$2.00 ea.

Total of all parts listed if purchased separately.\$32.00

801913 Kit price.....\$29.00 kit.

1966 Commander 4-Door and Station Wagon

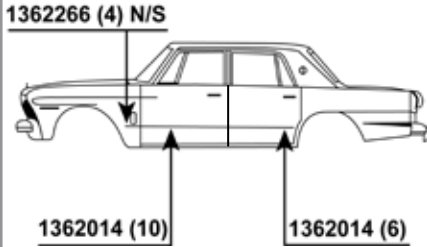

1362014 (16) Substitute 1358264.
.....\$2.00 ea.

Total of all parts listed if purchased separately.\$32.00

801914 Kit price \$29.00 kit.

1966 Daytona 2-Door

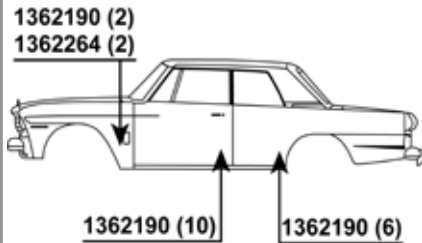

1362190 (18)\$1.50 ea.

1362264 (2)\$2.00 ea.

Total of all parts listed if purchased separately.\$41.00

801915 Kit price \$38.00 kit.

1966 Cruiser 4-Door

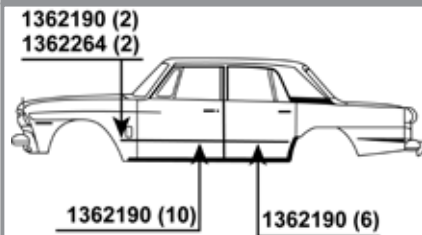

1362190 (18)\$1.50 ea.

1362264 (2)\$2.00 ea.

Total of all parts listed if purchased separately.\$41.00

801916 Kit price \$38.00 kit.

1957-64 Transtar

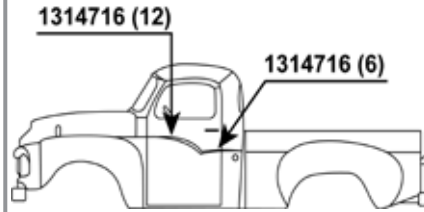

1314716 (18)\$2.00 ea.

Total of all parts listed if purchased separately.\$36.00

801917 Kit price.\$32.00 kit.

MOULDINGS

1953-54 Champion and Commander Deluxe and 1953 Champion and Commander Regal 2-Door Sedan (F3 & F5)



304784 Right side.....Call

304785 Left side Call

1953-54 Champion and Commander Deluxe and 1953 Champion and Commander Regal 4-Door Sedan (W3, W5, & Y5)



297912 Right side..... \$90.00 ea.

297913 Left side \$60.00 ea.

1954 Champion and Commander Regal 2-Door Sedan (F5)

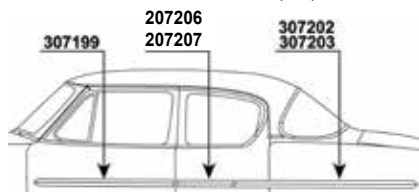

207206 Right side Call

207207 Left side..... Call

307199 Either side.....\$51.50 ea.

307202 Right side.....\$60.00 ea.

307203 Left side.....\$60.00 ea.

1954 Champion and Commander Deluxe Station Wagon (D3)

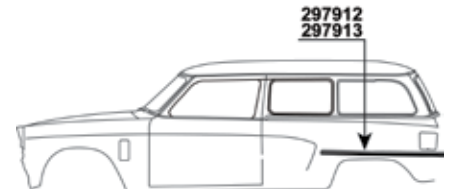

297912 Right side..... \$90.00 ea.

297913 Left side \$60.00 ea.

1954 Champion and Commander Regal 4-Door Sedan (W5)

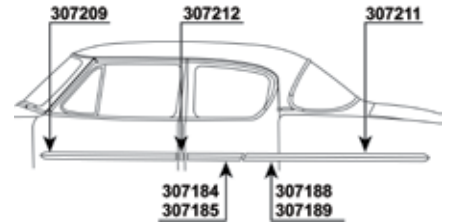

307184 Right side.....\$35.00 ea.

307185 Left side\$35.00 ea.

307188 Right side.....\$20.00 ea.

307189 Left side\$24.00 ea.

307209 Either side\$50.00 ea.

307211 Either side.....\$60.00 ea.

307212 Either side..... Call

1954 Land Cruiser 4-Door Sedan (Y5)

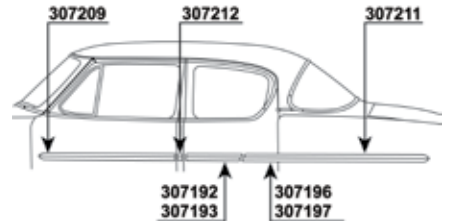

307192 Right side.....Call

307193 Left sideCall

307196 Right side.....Call

307197 Left side\$25.00 ea.

307209 Either side\$50.00 ea.

307211 Either side\$60.00 ea.

307212 Either side Call

1954 Champion and Commander Regal Station Wagon (D5)

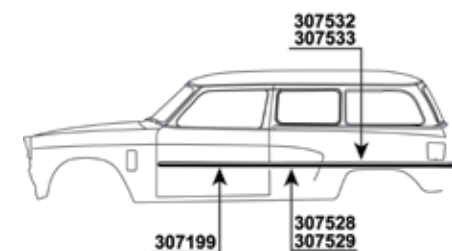

307199 Either side.....\$51.50 ea.

307528 Right side.....\$35.00 ea.

307529 Left side\$35.00 ea.

307532 Right side.....\$60.00 ea.

307533 Left side.....\$60.00 ea.

**1955 Champion Deluxe
2-Door Sedan (F3 & F4)**

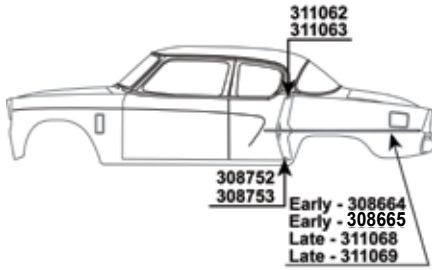

- 308664** Right side No stock
- 308665** Left side No stock
- 308752** Right side \$95.00 ea.
- 308753** Left side \$95.00 ea.
- 311062** Right side \$145.00 ea.
- 311063** Left side \$95.00 ea.
- 311068** Right side \$68.25 ea.
- 311069** Left side \$60.00 ea.

**1955 Champion Deluxe
4-Door Sedan (W3 & W4)**

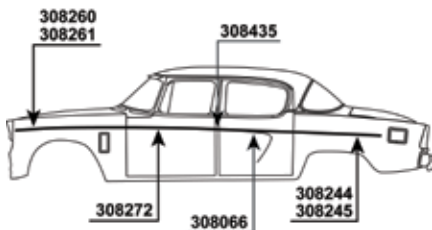

- 308066** Either side Call
- 308244** Right side \$110.00 ea.
- 308245** Left side \$52.00 ea.
- 308260** Right side \$75.00 ea.
- 308261** Left side \$110.00 ea.
- 308272** Either side \$50.00 ea.
- 308435** Either side Call

**1955 President State
4-Door Sedan (Y5 & Y6)**

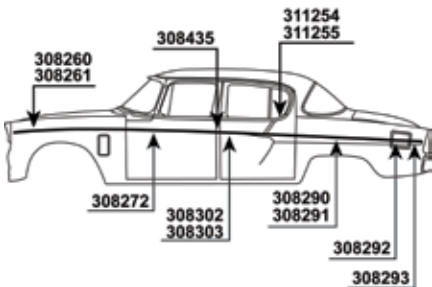

- 308260** Right side \$75.00 ea.
- 308261** Left side \$110.00 ea.
- 308272** Either side \$50.00 ea.
- 308290** Right side Call
- 308291** Left side \$95.00 ea.
- 308292** Left side \$26.50 ea.
- 308293** Left side \$26.50 ea.
- 308302** Right side \$45.00 ea.
- 308303** Left side \$68.25 ea.
- 308435** Either side Call
- 311254** Right side Call
- 311255** Left side Call

**1955 Champion Deluxe
4-Door Sedan (Y3 & Y4)**

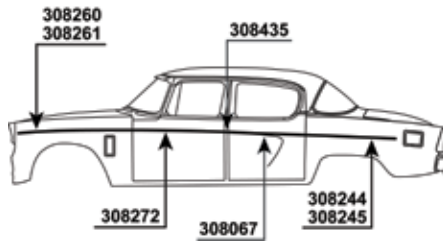

- 308067** Either side \$75.00 ea.
- 308244** Right side \$110.00 ea.
- 308245** Left side \$52.00 ea.
- 308260** Right side \$75.00 ea.
- 308261** Left side \$110.00 ea.
- 308272** Either side \$50.00 ea.
- 308435** Either side Call

**1955 Champion, Commander, President
Regal
4-Door Sedan (W5 & W6)**

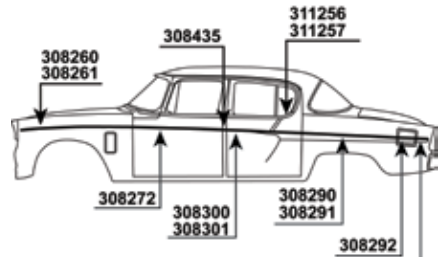

- 308260** Right side \$75.00 ea.
- 308261** Left side \$110.00 ea.
- 308272** Either side \$50.00 ea.
- 308290** Right side Call
- 308291** Left side \$95.00 ea.
- 308292** Left side \$26.50 ea.
- 308293** Left side \$26.50 ea.
- 308300** Right side \$45.00 ea.
- 308301** Left side \$68.25 ea.
- 308435** Either side Call
- 311256** Right side \$30.00 ea.
- 311257** Left side \$30.00 ea.

**1955 Conestoga Station Wagon
(D5, D6, D9, & D10)**

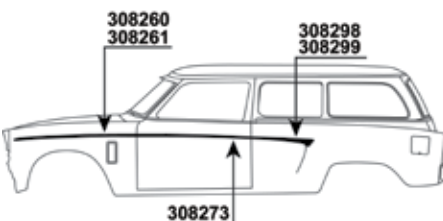

- 308260** Right side \$75.00 ea.
- 308261** Left side \$110.00 ea.
- 308273** Either side \$60.00 ea.
- 308298** Right side Call
- 308299** Left side \$51.50 ea.

**1955 Champion, Commander, President
2-Door Coupe & Hardtop (C3 & K3)**

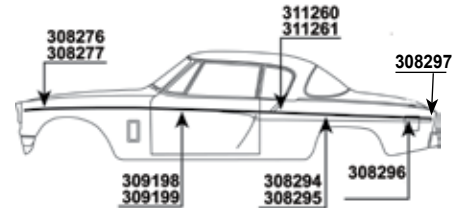

- 308276** Right side Call
- 308277** Left side \$95.00 ea.
- 308294** Right side No stock
- 308295** Left side \$110.00 ea.
- 308296** Left side \$26.50 ea.
- 308297** Left side \$26.50 ea.
- 309198** Right side \$110.00 ea.
- 309199** Left side \$110.00 ea.
- 311260** Right side \$42.00 ea.
- 311261** Left side \$42.00 ea.

**1955 President Speedster
2-Door Hardtop (K7)**

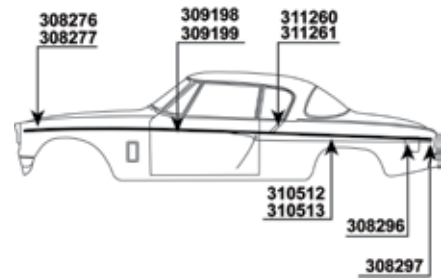

- 308276** Right side Call
- 308277** Left side \$95.00 ea.
- 308296** Left side \$26.50 ea.
- 308297** Left side \$26.50 ea.
- 309198** Right side \$110.00 ea.
- 309199** Left side \$110.00 ea.
- 310512** Right side Call
- 310513** Left side Call
- 311260** Right side \$42.00 ea.
- 311261** Left side \$42.00 ea.

**1956 Champion, Commander, Custom
2-Door Sedan (F2)**

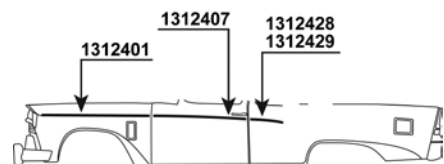

- 1312401** Either side \$95.00 ea.
- 1312407** Either side \$75.00 ea.
- 1312428** Right side \$45.00 ea.
- 1312429** Left side \$45.00 ea.

1956 Champion, Commander, Custom 4-Door Sedan (W2)

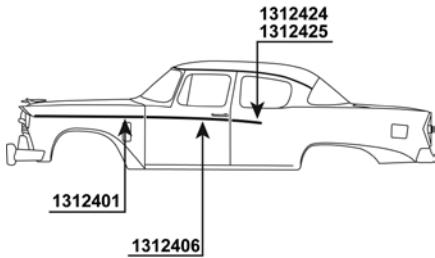

- 1312401** Either side \$95.00 ea.
- 1312406** Either side \$75.00 ea.
- 1312424** Right side Call
- 1312425** Left side \$45.00 ea.

1956 Champion, Commander, Deluxe 2-Door Sedan (F4)

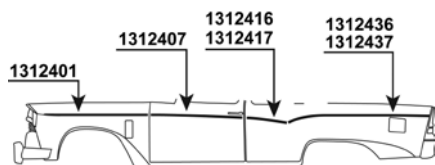

- 1312401** Either side \$95.00 ea.
- 1312407** Either side \$75.00 ea.
- 1312416** Right side \$35.00 ea.
- 1312417** Left side \$35.00 ea.
- 1312436** Right side \$60.00 ea.
- 1312437** Left side \$60.00 ea.

1956 Champion, Commander, Deluxe 4-Door Sedan (W4)

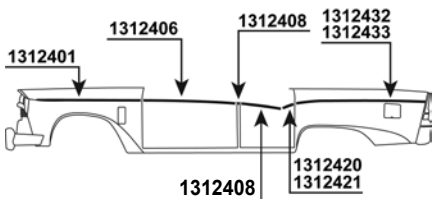

- 1312401** Either side \$95.00 ea.
- 1312406** Either side \$75.00 ea.
- 1312408** Either side \$20.00 ea.
- 1312412** Right side \$35.00 ea.
- 1312413** Left side \$35.00 ea.
- 1312420** Right side \$20.00 ea.
- 1312421** Left side \$18.00 ea.
- 1312432** Right side \$75.00 ea.
- 1312433** Left side \$75.00 ea.

- 1312406** Either side \$75.00 ea.
- 1312408** Either side \$20.00 ea.
- 1312401** Either side \$95.00 ea.
- 1312222** Right side \$85.00 ea.
- 1312223** Left side \$85.00 ea.
- 13124251** Either side \$75.00 ea.
- 13124256** Right side \$45.00 ea.
- 13124257** Left side \$45.00 ea.
- 13124258** Right side \$15.00 ea.
- 13124259** Left side Call
- 13124271** Right side \$75.00 ea.

1956 President 2-Door Sedan (F6)

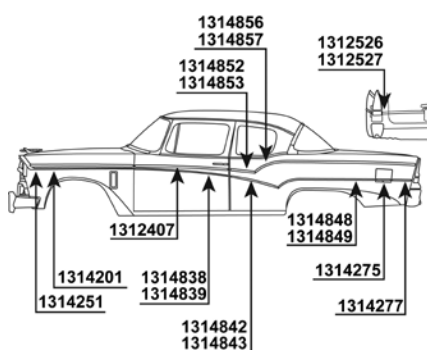

- 1312407** Either side \$75.00 ea.
- 1312526** Right side \$35.00 ea.
- 1312527** Left side No stock
- 1314201** Either side \$95.00 ea.
- 1314251** Either side \$75.00 ea.
- 1314275** Left side \$75.00 ea.
- 1314277** Left side \$18.00 ea.
- 1314838** Right side \$35.00 ea.
- 1314839** Left side Call
- 1314842** Right side \$45.00 ea.
- 1314843** Left side \$45.00 ea.
- 1314848** Right side \$75.00 ea.
- 1314849** Left side \$75.00 ea.
- 1314852** Right side \$35.00 ea.
- 1314853** Left side \$35.00 ea.
- 1314856** Right side \$45.00 ea.
- 1314857** Left side Call

1956 President 4-Door Sedan (W6)

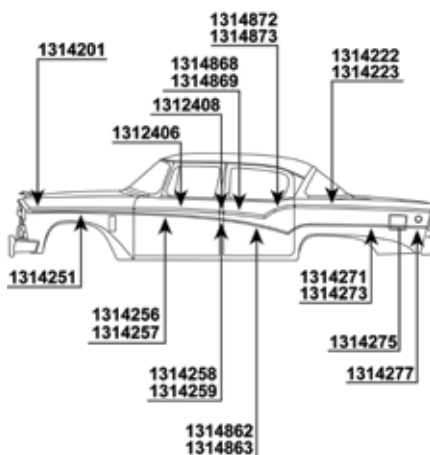

- 1314273** Left side \$75.00 ea.
- 1314275** Left side \$75.00 ea.
- 1314277** Left side \$18.00 ea.
- 1314862** Right side Call
- 1314863** Left side \$45.00 ea.
- 1314868** Right side \$30.00 ea.
- 1314869** Left side \$30.00 ea.
- 1314872** Right side \$35.00 ea.
- 1314873** Left side \$35.00 ea.

1956 President Classic 4-Door Sedan (Y6)

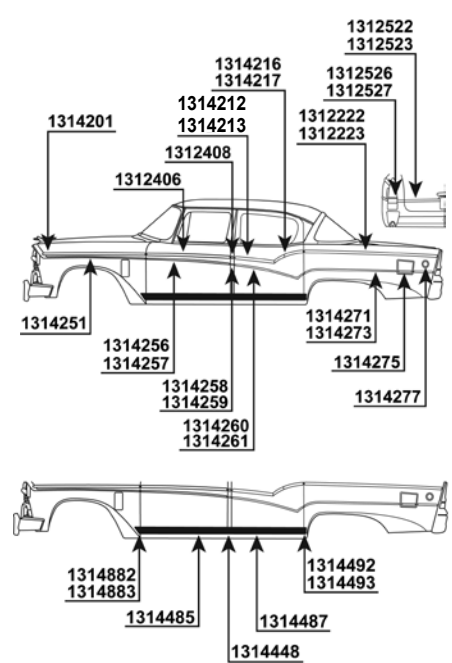

- 1312406** Either side \$75.00 ea.
- 1312408** Either side \$20.00 ea.
- 1312522** Right side \$35.00 ea.
- 1312523** Left side \$40.00 ea.
- 1312526** Right side \$35.00 ea.
- 1312527** Left side Call
- 1314201** Either side \$95.00 ea.
- 1314212** Right side \$45.00 ea.
- 1314213** Left side \$35.00 ea.
- 1314216** Right side \$45.00 ea.
- 1314217** Left side \$35.00 ea.
- 1314222** Right side \$85.00 ea.
- 1314223** Left side \$85.00 ea.
- 1314251** Either side \$75.00 ea.
- 1314256** Right side \$45.00 ea.
- 1314257** Left side \$45.00 ea.
- 1314258** Right side \$15.00 ea.
- 1314259** Left side Call
- 1314260** Right side Call
- 1314261** Left side \$75.00 ea.
- 1314271** Right side \$75.00 ea.
- 1314273** Left side \$75.00 ea.
- 1314275** Left side \$75.00 ea.
- 1314277** Left side \$18.00 ea.
- 1314485** Either side \$85.00 ea.
- 1314487** Either side Call
- 1314488** Either side \$20.00 ea.
- 1314492** Right side Call
- 1314493** Left side Call
- 1314882** Right side Call
- 1314883** Left side Call

1956 Pelham & Parkview Station Wagon (D4)

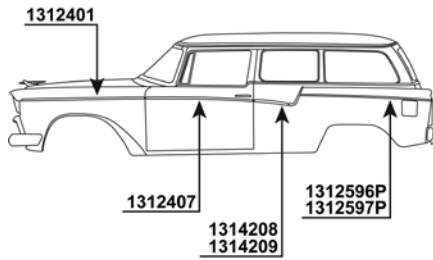

- 1312401** Either side \$95.00 ea.
- 1312407** Either side \$75.00 ea.
- 1312596P** Right painted bead Call
- 1312597P** Left, painted bead \$110.00 ea.
- 1314208** Right side \$45.00 ea.
- 1314209** Left side \$45.00 ea.

1956 Pinehurst Station Wagon (D6)

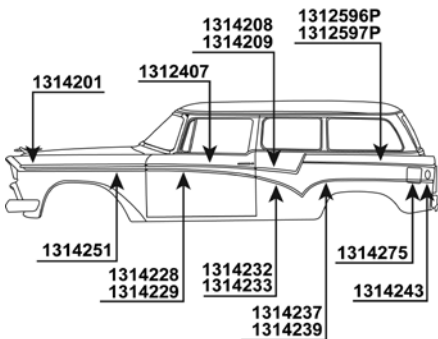

- 1312407** Either side \$75.00 ea.
- 1312596P** Right painted bead Call
- 1312597P** Left, painted bead \$110.00 ea.
- 1314201** Either side \$95.00 ea.
- 1314208** Right side \$45.00 ea.
- 1314209** Left side \$45.00 ea.
- 1314228** Right side \$60.00 ea.
- 1314229** Left side \$60.00 ea.
- 1314232** Right side \$45.00 ea.
- 1314233** Left side \$45.00 ea.
- 1314237** Right side Call
- 1314239** Left side \$75.00 ea.
- 1314243** Either side \$20.00 ea.
- 1314251** Either side \$75.00 ea.
- 1314275** Left side \$75.00 ea.

1956 Flight and Power Hawk (C3)

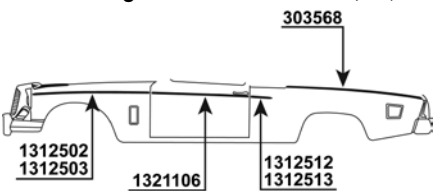

- 303568** Either side \$175.00 ea.
- 1312502** Right side \$110.00 ea.
- 1312503** Left side \$110.00 ea.
- 1312512** Right side \$45.00 ea.
- 1312513** Left side \$45.00 ea.
- 1321106** Either side \$95.00 ea.

1956 Sky Hawk (K7)

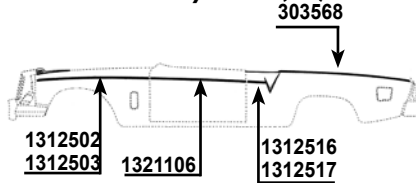

- 303568** Either side \$175.00 ea.
- 1312502** Right side \$110.00 ea.
- 1312503** Left side \$110.00 ea.
- 1312516** Right side \$35.00 ea.
- 1312517** Left side \$35.00 ea.
- 1321106** Either side \$95.00 ea.

1956 Golden Hawk (K7)

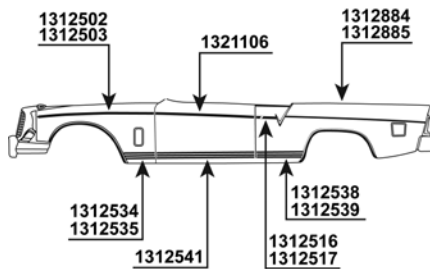

- 1312502** Right side \$110.00 ea.
- 1312503** Left side \$110.00 ea.
- 1312516** Right side \$35.00 ea.
- 1312517** Left side \$35.00 ea.
- 1312534** Right side Call
- 1312535** Left side Call
- 1312541** Either side Call
- 1312538** Right side \$70.00 ea.
- 1312539** Left side \$70.00 ea.
- 1312884** Right side Call
- 1312885** Left side Call
- 1321106** Either side \$95.00 ea.

1957 Champion and Commander Custom 2-Door Sedan (F2)

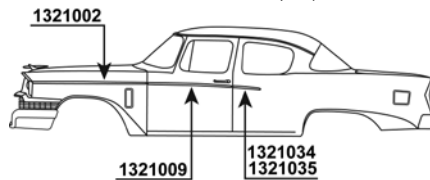

- 1321002** Either side \$95.00 ea.
- 1321009** Either side \$75.00 ea.
- 1323034** Right side \$35.00 ea.
- 1323035** Left side \$35.00 ea.

1957 Champion and Commander Custom 4-Door Sedan (W2)

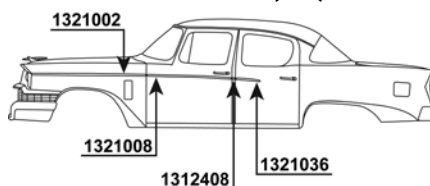

- 1312408** Either side \$20.00 ea.
- 1321002** Either side \$95.00 ea.
- 1321008** Either side \$60.00 ea.
- 1321036** Either side \$35.00 ea.

1957 Champion and Commander Deluxe 4-Door Sedan (W4)

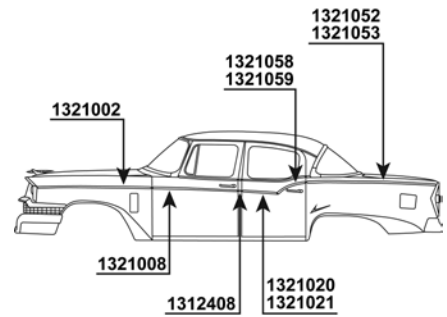

- 1312408** Either side \$20.00 ea.
- 1321002** Either side \$95.00 ea.
- 1321008** Either side \$60.00 ea.
- 1321020** Right side \$35.00 ea.
- 1321021** Left side \$35.00 ea.
- 1321052** Right side \$75.00 ea.
- 1321053** Left side \$75.00 ea.
- 1321058** Right side \$35.00 ea.
- 1321059** Left side \$35.00 ea.

1957 Champion and Commander Deluxe 2-Door Sedan (F4)

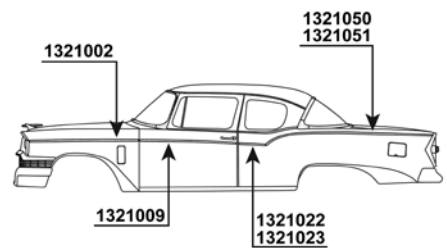

- 1321002** Either side \$95.00 ea.
- 1321009** Either side \$75.00 ea.
- 1321022** Right side \$35.00 ea.
- 1321023** Left side \$35.00 ea.
- 1321050** Right side \$110.00 ea.
- 1321051** Left side \$110.00 ea.

1957 President 2-Door Sedan (F6)

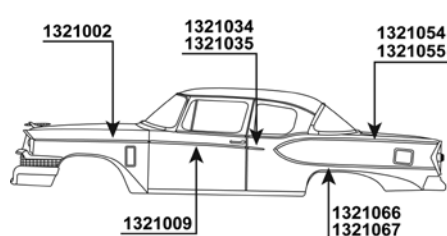

- 1321002** Either side \$95.00 ea.
- 1321009** Either side \$75.00 ea.
- 1321034** Right side \$35.00 ea.
- 1321035** Left side \$35.00 ea.
- 1321054** Right side \$120.00 ea.
- 1321055** Left side \$120.00 ea.
- 1321066** Right side \$95.00 ea.
- 1321067** Left side \$95.00 ea.

1957 President 4-Door Sedan (W6)

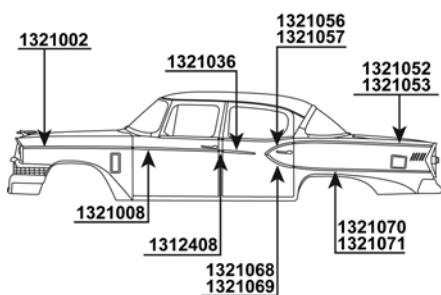

- 1312408** Either side \$20.00 ea.
- 1321002** Either side \$95.00 ea.
- 1321008** Either side \$60.00 ea.
- 1321034** Right side \$35.00 ea.
- 1321035** Left side \$35.00 ea.
- 1321036** Either side \$35.00 ea.
- 1321052** Right side \$75.00 ea.
- 1321053** Left side \$75.00 ea.
- 1321056** Right side \$35.00 ea.
- 1321057** Left side \$35.00 ea.
- 1321068** Right side \$35.00 ea.
- 1321069** Left side \$35.00 ea.
- 1321071** Left side \$75.00 ea.

1957 Pelham and Pinehurst 2-Door Station Wagon (D4, D7)

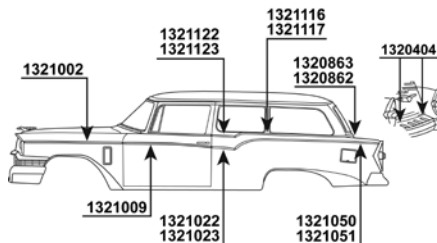

- 1320404** Rear. Takes 6 \$35.00 ea.
- 1320862** Right side Call
- 1320863** Left side Call
- 1321002** Either side \$95.00 ea.
- 1321009** Either side \$75.00 ea.
- 1321022** Right side \$35.00 ea.
- 1321023** Left side \$35.00 ea.
- 1321050** Right side \$110.00 ea.
- 1321051** Left side \$110.00 ea.
- 1321116** Right side Call
- 1321117** Left side Call
- 1321122** Right side Call
- 1321123** Left side Call

1957 Broadmoor 4-Door Station Wagon (P6)

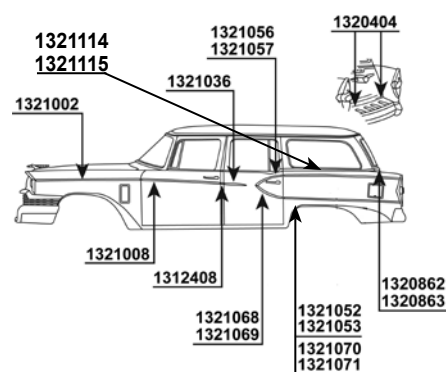

- 1312408** Either side \$20.00 ea.
- 1320404** Rear lower. Takes 6 \$35.00 ea.
- 1320862** Right side Call
- 1320863** Left side Call
- 1321002** Either side \$95.00 ea.
- 1321008** Either side \$60.00 ea.
- 1321036** Either side \$35.00 ea.
- 1321052** Right side \$75.00 ea.
- 1321053** Left side \$75.00 ea.
- 1321056** Right side \$35.00 ea.
- 1321057** Left side \$35.00 ea.
- 1321068** Right side \$35.00 ea.
- 1321069** Left side \$35.00 ea.
- 1321071** Left side \$75.00 ea.
- 1321114** Right side \$110.00 ea.
- 1321115** Left side Call

www.studebaker-intl.com
(317) 462-3124

1957 President 4-Door Sedan (Y6)

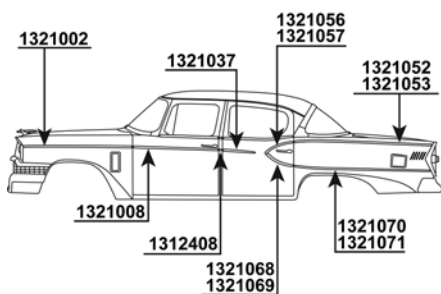

- 1312408** Either side \$20.00 ea.
- 1321002** Either side \$95.00 ea.
- 1321008** Either side \$60.00 ea.
- 1321037** Either side \$35.00 ea.
- 1321052** Right side \$75.00 ea.
- 1321053** Left side \$75.00 ea.
- 1321056** Right side \$35.00 ea.
- 1321057** Left side \$35.00 ea.
- 1321068** Right side \$35.00 ea.
- 1321069** Left side \$35.00 ea.
- 1321071** Left side \$75.00 ea.

1957 Parkview and Provincial 4-Door Station Wagon (P4)

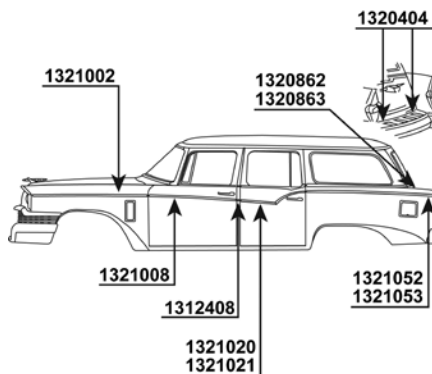

- 1312408** Either side \$20.00 ea.
- 1320404** Rear. Takes 6 \$35.00 ea.
- 1320862** Right side Call
- 1320863** Left side Call
- 1321002** Either side \$95.00 ea.
- 1321008** Either side \$60.00 ea.
- 1321020** Right side \$35.00 ea.
- 1321021** Left side \$35.00 ea.
- 1321052** Right side \$75.00 ea.
- 1321053** Left side \$75.00 ea.

1957 Packard 4-Door Sedan (57L-Y)

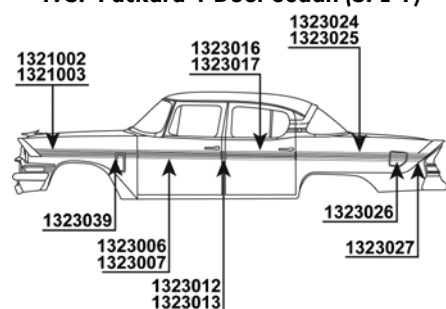

- 1323002** Right side \$95.00 ea.
- 1323003** Left side \$95.00 ea.
- 1323006** Right side \$95.00 ea.
- 1323007** Left side \$95.00 ea.
- 1323012** Left side \$35.00 ea.
- 1323013** Left side \$35.00 ea.
- 1323016** Right side \$65.00 ea.
- 1323017** Left side \$65.00 ea.
- 1323024** Right side \$110.00 ea.
- 1323025** Left side \$100.00 ea.
- 1323026** Gas filler door \$20.00 ea.
- 1323027** Left side \$38.25 ea.
- 1323039** Either side Call

1957-58 Silver Hawk (C3)

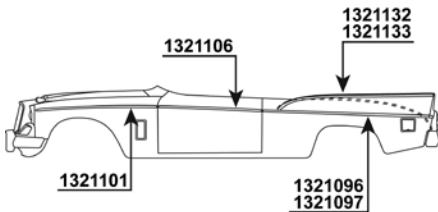

- 1321101** Either side..... **NO STOCK**
- 1321106** Either side..... **\$95.00 ea.**
- 1321096** Right side..... **Call**
- 1321097** Left side..... **\$175.00 ea.**
- 1321132** Right side..... **\$110.00 ea.**
- 1321133** Left side..... **\$110.00 ea.**

1957-58 Golden Hawk (K-7) 1958 Packard Hawk (58L-K9)

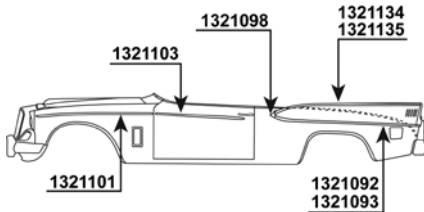

- 1321092** Right side..... **\$150.00 ea.**
- 1321093** Left side..... **\$150.00 ea.**
- 1321098** Either side..... **Call**
- 1321101** Either side..... **NO STOCK**
- 1321103** Either side..... **Call**
- 1321134** Right side..... **Call**
- 1321135** Left side..... **\$195.00 ea.**

1957 Packard 4-Door Station Wagon (57L-P)

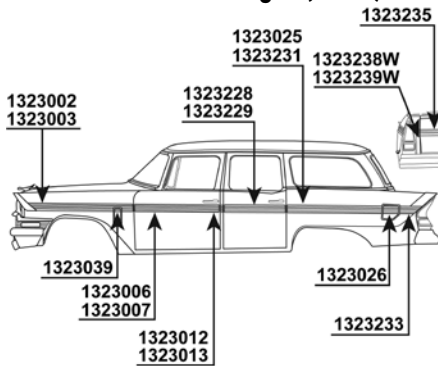

- 1323002** Right side..... **\$95.00 ea.**
- 1323003** Left side..... **\$95.00 ea.**
- 1323006** Right side..... **\$95.00 ea.**
- 1323007** Left side..... **\$95.00 ea.**
- 1323012** Right side..... **\$35.00 ea.**
- 1323013** Left side..... **\$35.00 ea.**
- 1323025** Left side..... **\$100.00 ea.**
- 1323026** Gas filler door..... **\$20.00 ea.**
- 1323039** Either side..... **Call**
- 1323228** Right side..... **\$75.00 ea.**
- 1323229** Left side..... **\$75.00 ea.**
- 1323231** Right side..... **Call**
- 1323233** Left side..... **Call**
- 1323235** Either side..... **Call**
- 1323238** Right side..... **Call**
- 1323239** Left side..... **Call**

1958 Champion and Commander Deluxe 2-Door Sedan (F4)

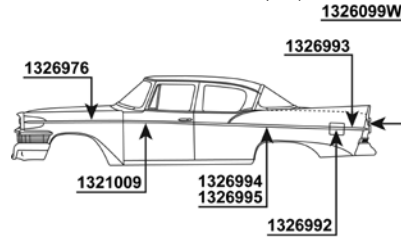

- 1321009** Either side..... **\$75.00 ea.**
- 1326099W** Either side..... **Call**
- 1326920** Right side..... **Call**
- 1326921** Left side..... **Call**
- 1326976** Either side..... **\$75.00 ea.**
- 1326992** Gas lid..... **\$25.00 ea.**
- 1326993** Left side..... **\$25.00 ea.**
- 1326994** Right side..... **\$125.00 ea.**
- 1326995** Left side..... **Call**

1958 Champion and Commander 4-Door Sedan (W4)

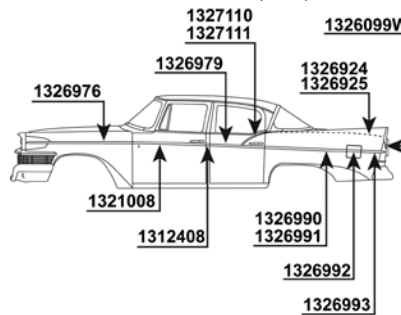

- 1312408** Either side..... **\$20.00 ea.**
- 1321008** Either side..... **\$60.00 ea.**
- 1326099W** Either side..... **Call**
- 1326924** Right side..... **\$60.00 ea.**
- 1326925** Left side..... **\$80.00 ea.**
- 1326976** Either side..... **\$75.00 ea.**
- 1326979** Either side..... **Call**
- 1326990** Right side..... **\$85.00 ea.**
- 1326991** Left side..... **\$26.50 ea.**
- 1326992** Gas lid..... **\$25.00 ea.**
- 1326993** Left side..... **\$25.00 ea.**
- 1327110** Right side..... **\$26.50 ea.**
- 1327111** Left side..... **\$26.50 ea.**

1958 President Classic 4-Door Sedan (Y6)

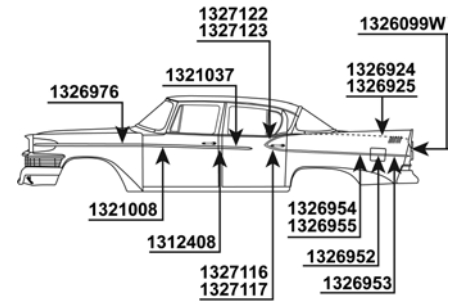

- 1312408** Either side..... **\$20.00 ea.**
- 1321008** Either side..... **\$60.00 ea.**
- 1321037** Either side..... **\$35.00 ea.**
- 1326099W** Either side..... **Call**
- 1326924** Right side..... **\$60.00 ea.**
- 1326925** Left side..... **\$80.00 ea.**
- 1326952** Left side..... **\$20.75 ea.**
- 1326953** Left side..... **\$25.00 ea.**
- 1326954** Right side..... **\$95.00 ea.**
- 1326976** Either side..... **\$75.00 ea.**
- 1326990** Right side..... **\$85.00 ea.**
- 1327116** Right side..... **\$18.00 ea.**
- 1327117** Left side..... **\$18.00 ea.**
- 1327122** Right side..... **\$18.00 ea.**
- 1327123** Left side..... **\$18.00 ea.**

1958 Commander Deluxe 2-Door Hardtop (58B-J4)

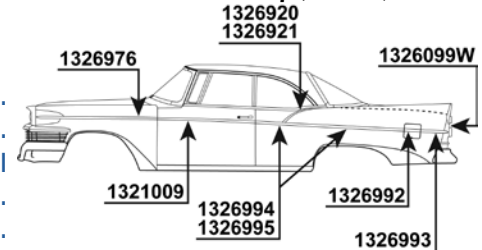

- 1321009** Either side..... **\$75.00 ea.**
- 1326099W** Either side..... **Call**
- 1326920** Right side..... **Call**
- 1326921** Left side..... **Call**
- 1326976** Either side..... **\$75.00 ea.**
- 1326992** Gas lid..... **\$25.00 ea.**
- 1326993** Left side..... **\$25.00 ea.**
- 1326994** Right side..... **\$125.00 ea.**
- 1326995** Left side..... **Call**

1958 President Regal (2-dr Hardtop (58H-J6)

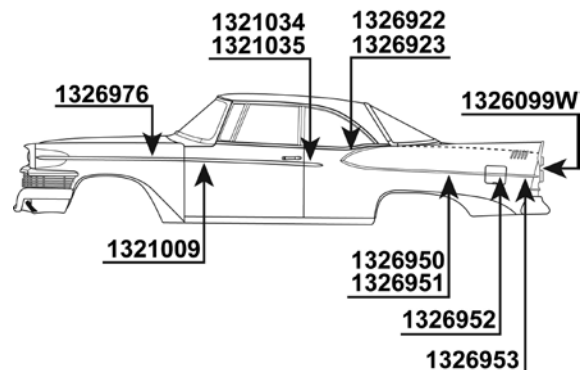

- 1321009** Either side..... **\$75.00 ea.**
- 1321034** Right side..... **\$35.00 ea.**
- 1321035** Left side..... **\$35.00 ea.**
- 1326099W** Either side..... **Call**
- 1326922** Right side..... **\$85.00 ea.**
- 1326923** Left side..... **\$85.00 ea.**
- 1326950** Right side..... **Call**
- 1326951** Left side..... **\$75.00 ea.**
- 1326952** Left side..... **\$20.75 ea.**
- 1326953** Left side..... **\$25.00 ea.**
- 1326976** Either side..... **\$75.00 ea.**

1958 Packard 4-Door Sedan (58L-Y)

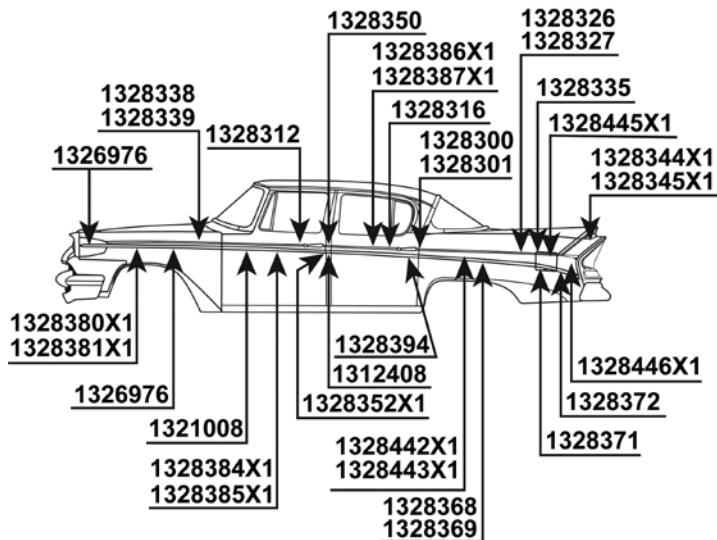

1312408 Either side	\$20.00 ea.	1328368 Right side	\$75.00 ea.
1321008 Either side	\$60.00 ea.	1328369 Left side	Call
1326976 Either side	\$75.00 ea.	1328371 Lower gas filler door	\$25.00 ea.
1328300 Right side	\$15.00 ea.	1328372 Left side	\$22.25 ea.
1328301 Left side	\$15.00 ea.	1328380X1 Either side	Call
1328312 Either side	Call	1328381X1 Either side	Call
1328316 Either side	\$45.00 ea.	1328384X1 Either side	Call
1328326 Right side	\$110.00 ea.	1328385X1 Either side	Call
1328327 Left side	\$95.00 ea.	1328386X1 Right side	Call
1328335 Upper glass lid	\$51.50 ea.	1328387X1 Right side	Call
1328338 Right side	Call	1328394 Either side	\$45.00 ea.
1328339 Left side	\$75.00 ea.	1328442X1 Right overlay	Call
1328344X1 Right overlay	\$65.00 ea.	1328443X1 Left overlay	Call
1328345X1 Left overlay	Call	1328445X1 Left side	Call
1328350 Either side	Call	1328446X1 Left side	Call
1328352X1 Either side	Call		

1958 Packard 2-Door Hardtop (58L-J8)

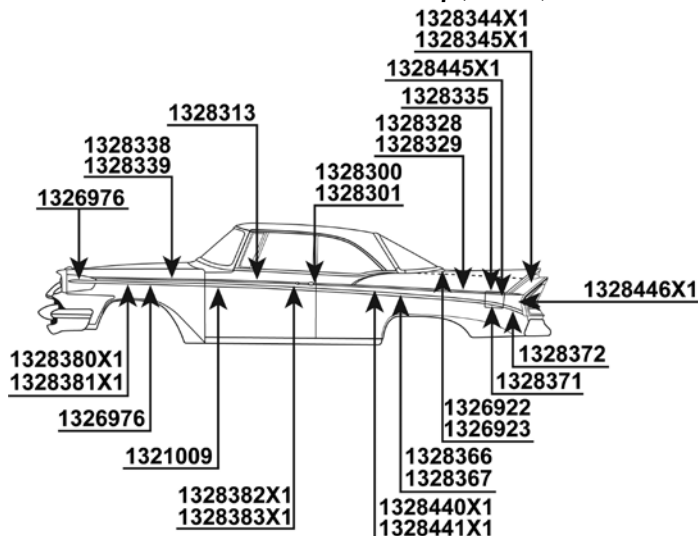

1321009 Either side	\$75.00 ea.	1328345X1 Either side	Call
1326922 Right side	\$85.00 ea.	1328366 Right side	\$80.00 ea.
1326923 Left side	\$85.00 ea.	1328367 Left side	Call
1326976 Either side	\$75.00 ea.	1328371 Lower gas filler door	\$25.00 ea.
1328300 Right side	\$15.00 ea.	1328372 Left side	\$22.25 ea.
1328301 Left side	\$15.00 ea.	1328380X1 Right side	Call
1328313 Either side	Call	1328381X1 Left side	Call
1328328 Right side	Call	1328382X1 Right side	Call
1328329 Left side	Call	1328383X1 Left side	Call
1328335 Upper gas lid	\$51.50 ea.	1328440X1 Right overlay	Call
1328338 Right side	Call	1328441X1 Left overlay	Call
1328339 Left side	\$75.00 ea.	1328445X1 Left side	Call
1328344X1 Right overlay	\$65.00 ea.	1328446X1 Left side	Call

1958 Provincial Station Wagon (P4)

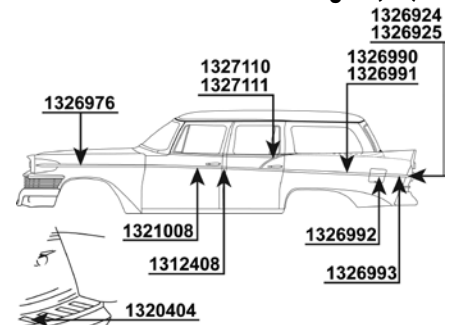

1312408 Either side	\$20.00 ea.	1326924 Right side	\$60.00 ea.
1320404 Rear	\$35.00 ea.	1326925 Left side	\$80.00 ea.
1321008 Either side	\$60.00 ea.	1326976 Either side	\$75.00 ea.
1326924 Right side	\$60.00 ea.	1326990 Right side	\$85.00 ea.
1326925 Left side	\$80.00 ea.	1326991 Left side	\$26.50 ea.
1326976 Either side	\$75.00 ea.	1326992 Gas lid	\$25.00 ea.
1326990 Right side	\$85.00 ea.	1326993 Left side	\$25.00 ea.
1326991 Left side	\$26.50 ea.	1327110 Right side	\$26.50 ea.
1326992 Gas lid	\$25.00 ea.	1327111 Left side	\$26.50 ea.
1326993 Left side	\$25.00 ea.		

1959 Lark 2-Door Sedan (F4) & 2-Door Hardtop (J6)

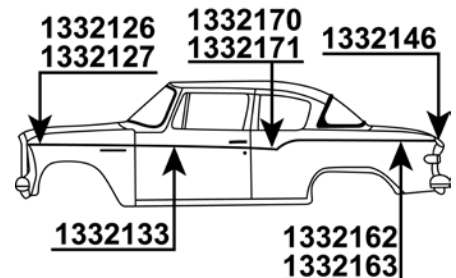

1332126 Right side	No Stock
1332127 Left side	\$75.00 ea.
1332133 Either side	\$35.00 ea.
1332146 Rear	\$60.00 ea.
1332162 Right side	\$60.00 ea.
1332163 Left side	\$60.00 ea.
1332170 Right side	\$25.00 ea.
1332171 Left side	\$25.00 ea.

1959 Lark 4-Door Sedan (W4 & W6)

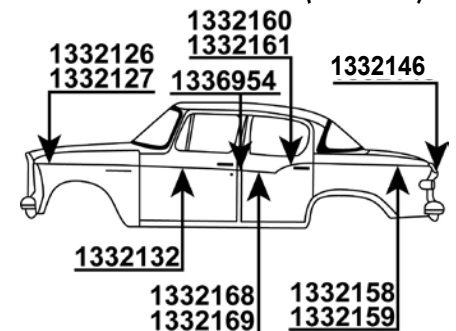

1332126 Right side	No Stock
1332127 Left side	\$75.00 ea.
1332132 Either side	\$65.00 ea.
1332146 Rear	\$60.00 ea.
1332158 Right side	\$45.00 ea.
1332159 Left side	\$45.00 ea.
1332160 Right side	\$18.00 ea.
1332161 Left side	\$18.00 ea.
1332168 Right side	\$13.25 ea.
1332169 Left side	\$13.25 ea.
1336954 Either side	\$10.25 ea.

1958 Packard Station Wagon (58L-P8)

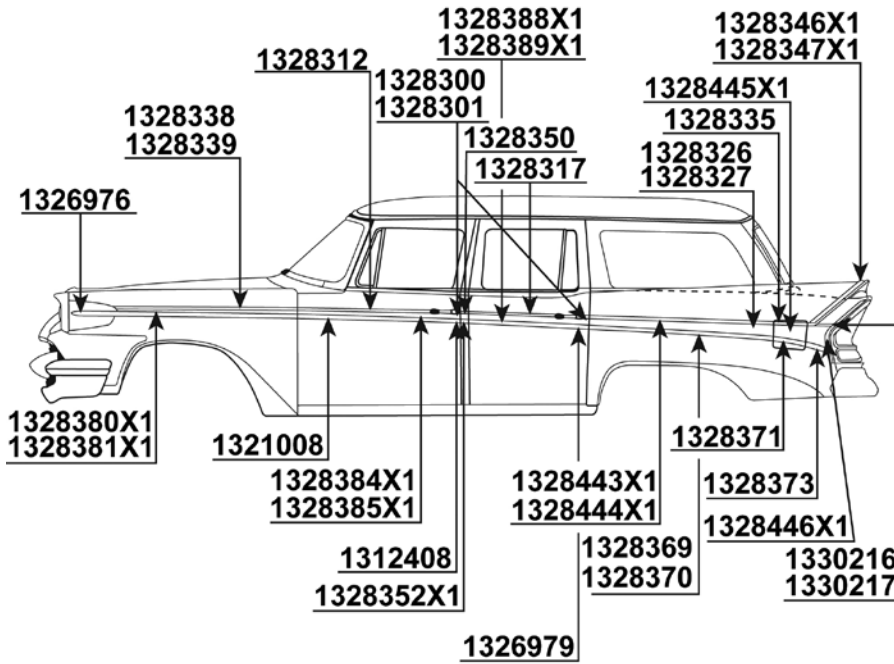

- | | |
|--|--|
| 1321008 Either side \$60.00 ea. | 1328369 Lower left Call |
| 1312408 Either side \$20.00 ea. | 1328370 Lower right \$110.00 ea. |
| 1326976 Either side \$75.00 ea. | 1328371 Lower gas filler door \$25.00 ea. |
| 1326979 Either side Call | 1328373 Left side \$35.00 ea. |
| 1328300 Right side \$15.00 ea. | 1328380X1 Right side Call |
| 1328301 Left side \$15.00 ea. | 1328381X1 Left side Call |
| 1328312 Either side Call | 1328384X1 Right side Call |
| 1328317 Either side Call | 1328385X1 Left side Call |
| 1328326 Right side \$110.00 ea. | 1328388X1 Right side Call |
| 1328327 Left side \$95.00 ea. | 1328389X1 Left side Call |
| 1328335 above gas lid \$51.50 ea. | 1328443X1 Left overlay Call |
| 1328338 Right side Call | 1328444X1 Left overlay Call |
| 1328339 Left side \$75.00 | 1328445X1 Left side Call |
| 1328346X1 Right overlay Call | 1328446X1 Left side Call |
| 1328347X1 Left overlay Call | 1330216 Right side Call |
| 1328350 Either side Call | 1330217 Left side Call |
| 1328352X1 Either side Call | |

1959 Lark 2-Door Wagon (D4 & D6)

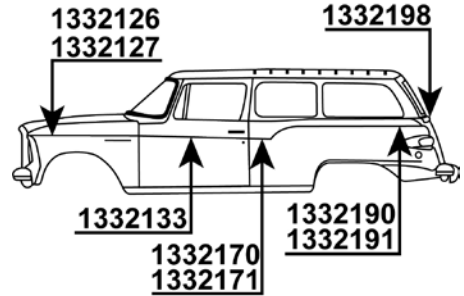

- | |
|--|
| 1332126 Right side No Stock |
| 1332127 Left side \$75.00 ea. |
| 1332133 Either side \$35.00 ea. |
| 1332170 Right side \$25.00 ea. |
| 1332171 Left side \$25.00 ea. |
| 1332190 Right side \$90.00 ea. |
| 1332191 Left side \$90.00 ea. |
| 1332198 Rear \$60.00 ea. |

1959-60 Hawk (C6)

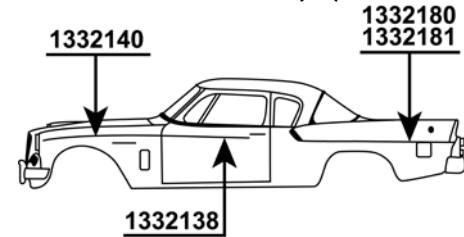

- | |
|---|
| 1332138 Either side \$110.00 ea. |
| 1332140 Either side \$110.00 ea. |
| 1332180 Right side Call |
| 1332181 Left side Call |

1960 Lark 2-Door Sedan, Hardtop, or Convertible

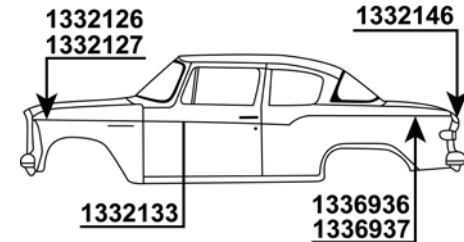

- | |
|--|
| 1332126 Right side No Stock |
| 1332127 Left side \$75.00 ea. |
| 1332133 Either side \$35.00 ea. |
| 1332146 Rear \$60.00 ea. |
| 1336936 Right side \$95.00 ea. |
| 1336937 Left side \$95.00 ea. |



ORDER ONLINE
at
WWW.STUDEBAKER-INTL.COM

1960 Lark 4-Door Sedan (W4 & W6)

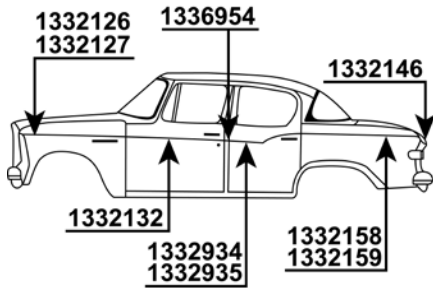

1332126 Right side	No Stock
1332127 Left side.....	\$75.00 ea.
1332132 Either side	\$65.00 ea.
1332146 Rear.....	\$60.00 ea.
1332158 Right side	\$45.00 ea.
1332159 Left side.....	\$45.00 ea.
1332934 Right side	\$65.00 ea.
1332935 Left side.....	\$50.00 ea.
1336954 Either side	\$10.25 ea.

1960 Lark 2-Door Wagon (D4 & D6)

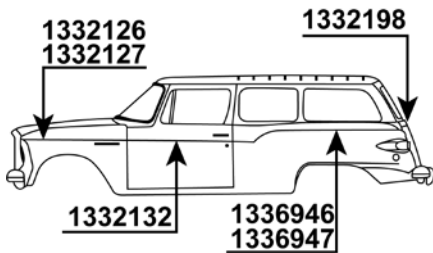

1332126 Right side	No Stock
1332127 Left side.....	\$75.00 ea.
1332133 Either side	\$35.00 ea.
1332198 Rear.....	\$60.00 ea.
1336946 Right side	\$95.00 ea.
1336947 Left side.....	\$95.00 ea.

1960 Lark 4-Door Wagon (P4 & P6)

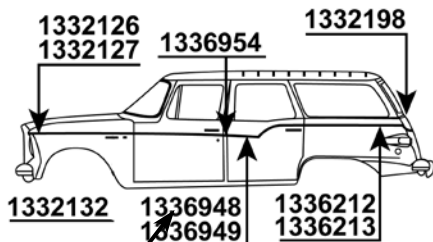

1332126 Right side	No Stock
1332127 Left side.....	\$75.00 ea.
1332132 Either side	\$65.00 ea.
1332198 Rear.....	\$60.00 ea.
1336212 Right side	\$75.00 ea.
1336213 Left side.....	\$75.00 ea.
1336948 Right side	\$75.00 ea.
1336949 Left side.....	\$75.00 ea.
1336954 Either side	\$10.25 ea.

1961 Lark 2-Door Sedan (F4), 2-Door Hardtop (J6), & Convertible (L6)

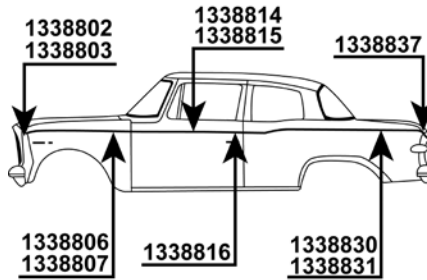

1338802 Right side	\$20.00 ea.
1338803 Left side.....	\$20.00 ea.
1338806 Right side	\$65.00 ea.
1338807 Left side.....	\$65.00 ea.
1338814 Right side	\$45.00 ea.
1338815 Left side.....	Call
1338816 Either side, behind the door handle.....	\$5.00 ea.
1338830 Right side	\$75.00 ea.
1338831 Left side.....	\$75.00 ea.
1338837 Left side.....	\$60.00 ea.

1961 Lark 4-Door Sedan (W4 & W6)

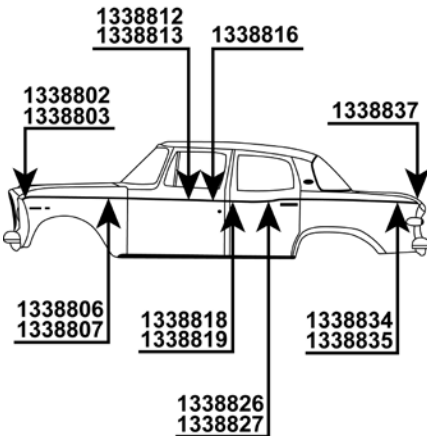

1338802 Right side	\$20.00 ea.
1338803 Left side.....	\$20.00 ea.
1338806 Right side	\$65.00 ea.
1338807 Left side.....	\$65.00 ea.
1338812 Right side	\$45.00 ea.
1338813 Left side.....	\$45.00 ea.
1338816 Either side, behind the door handle.....	\$5.00 ea.
1338818 Right side	\$4.00 ea.
1338819 Left side.....	\$13.25 ea.
1338826 Right side	\$45.00 ea.
1338827 Left side.....	\$65.00 ea.
1338834 Right side	\$45.00 ea.
1338835 Left side.....	\$45.00 ea.
1338837 Rear.....	\$60.00 ea.

1961 Lark Cruiser 4-Door Sedan (Y6)

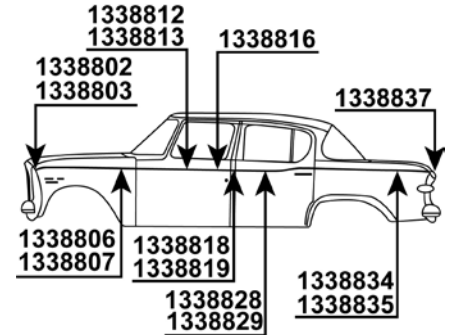

1338802 Right side	\$20.00 ea.
1338803 Left side.....	\$20.00 ea.
1338806 Right side	\$65.00 ea.
1338807 Left side.....	\$65.00 ea.
1338812 Right side	\$45.00 ea.
1338813 Left side.....	\$45.00 ea.
1338816 Either side, behind the door handle.....	\$5.00 ea.
1338818 Right side	\$4.00 ea.
1338819 Left side.....	\$13.25 ea.
1338828 Right side	\$45.00 ea.
1338829 Left side.....	\$45.00 ea.
1338834 Right side	\$45.00 ea.
1338835 Left side.....	\$45.00 ea.
1338837 Rear.....	\$60.00 ea.

(317) 462-3124

www.studebaker-intl.com

1961 Lark 2-Door Wagon (D4)

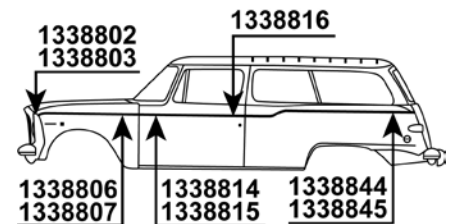

1338802 Right side	\$20.00 ea.
1338803 Left side.....	\$20.00 ea.
1338806 Right side	\$65.00 ea.
1338807 Left side.....	\$65.00 ea.
1338814 Right side	\$45.00 ea.
1338815 Left side.....	Call
1338816 Either side, behind the door handle.....	\$3.00 ea.
1338844 Right side.....	Call
1338845 Left side.....	Call

1961 Lark 4-Door Wagon (P4 & P6)

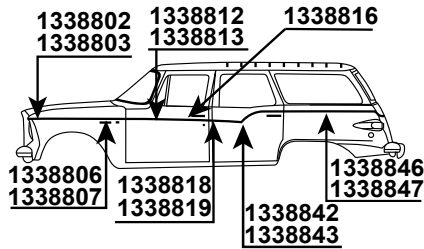

- 1338802** Right side \$20.00 ea.
- 1338803** Left side \$20.00 ea.
- 1338806** Right side \$65.00 ea.
- 1338807** Left side \$65.00 ea.
- 1338812** Right side \$45.00 ea.
- 1338813** Left side \$45.00 ea.
- 1338816** Either side, behind the door handle \$5.00 ea.
- 1338818** Right side \$4.00 ea.
- 1338819** Left side \$13.25 ea.
- 1338842** Right side \$45.00 ea.
- 1338843** Right side \$45.00 ea.
- 1338846** Right side \$60.00 ea.
- 1338847** Left side \$45.00 ea.

1961 Hawk 2-Door Coupe (C6)

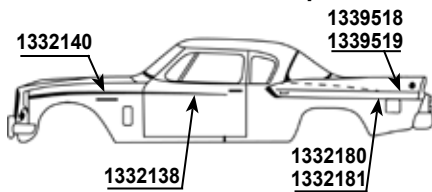

- 1332138** Either side \$110.00 ea.
- 1332140** Either side \$110.00 ea.
- 1332180** Right side Call
- 1332181** Left side Call
- 1339518** Right side \$100.00 ea.
- 1339519** Left side Call

1962 Lark 2-Door Sedan (F4), Regal 2-Door Hardtop (J6), & 2-Door Regal Convertible (L6)

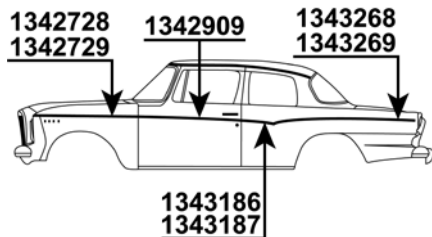

- 1342728** Right side \$75.00 ea.
- 1342729** Left side \$75.00 ea.
- 1342909** Either side \$45.00 ea.
- 1343186** Right side \$60.00 ea.
- 1343187** Left side \$30.00 ea.
- 1343268** Right side \$60.00 ea.
- 1343269** Left side \$60.00 ea.

1962 Lark & Cruiser 4-Door Sedan (Y4 & Y6)

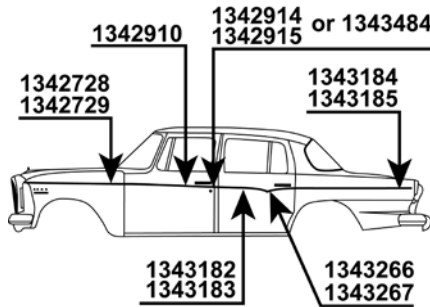

- 1342728** Right side \$75.00 ea.
- 1342729** Left side \$75.00 ea.
- 1342910** Either side \$45.00 ea.
- 1342914** Right side (early 1962) \$10.25 ea.
- 1342915** Left side (early 1962) \$10.25 ea.
- 1343182** Right side \$30.00 ea.
- 1343183** Left side \$30.00 ea.
- 1343184** Right side \$45.00 ea.
- 1343185** Left side \$45.00 ea.
- 1343266** Right side \$22.25 ea.
- 1343267** Left side Call
- 1343484** Either side (late 1962) \$10.25 ea.

Hours:
Our Studebaker International Stores are open Monday thru Friday from 8 am to 5 pm, Eastern Standard Time. Our telephone Ordering lines are open Monday through Friday 8 am - 6 pm (EST)

1962 Lark 4-Door Wagon (P4 & P6)

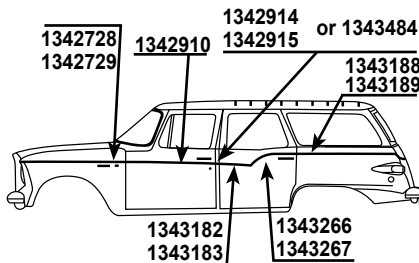

- 1342728** Right side \$75.00 ea.
- 1342729** Left side \$75.00 ea.
- 1342910** Either side \$45.00 ea.
- 1342914** Right side (early 1962) \$10.25 ea.
- 1342915** Left side (early 1962) \$10.25 ea.
- 1343182** Right side \$30.00 ea.
- 1343183** Left side \$30.00 ea.
- 1343188** Right side \$20.00 ea.
- 1343189** Left side \$30.00 ea.
- 1343266** Right side \$22.25 ea.
- 1343267** Left side Call
- 1343484** Either side (late 1962) \$10.25 ea.

1962 Lark Daytona 2-Door Hardtop (J8) & 2-Door Convertible (L8)

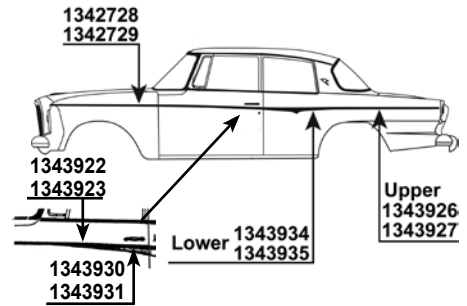

- 1342728** Right side \$75.00 ea.
- 1342729** Left side \$75.00 ea.
- 1343922** Right side No Stock
- 1343923** Left side \$45.00 ea.
- 1343926** Upper right \$110.00 ea.
- 1343927** Upper left \$75.00 ea.
- 1343930** Right side \$30.00 ea.
- 1343931** Left side \$30.00 ea.
- 1343934** Lower right Call
- 1343935** Lower left Call

Early 1962 GT Hawk (K6)

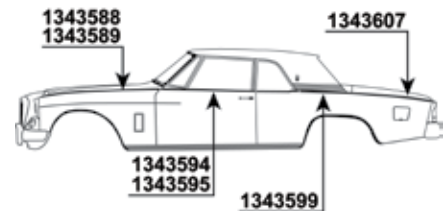

- 1343588** Right side Call
- 1343589** Left side Call
- 1343594** Right side \$60.00 ea.
- 1343595** Left side \$90.00 ea.
- 1343599** Either side \$40.00 ea.
- 1343607** Either side Call

Late 1962 GT Hawk (K6)

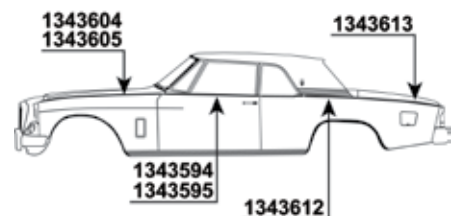

- 1343594** Right side \$60.00 ea.
- 1343595** Left side \$90.00 ea.
- 1343604** Right side Call
- 1343605** Left side \$110.00
- 1343612** Right side Call
- 1343613** Left side \$57.25 ea.

1963 Lark Regal 2-Door Sedan (F2 & F4)

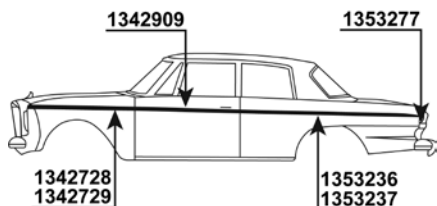

- 1342728** Right side \$75.00 ea.
- 1342729** Left side \$75.00 ea.
- 1342909** Either side \$45.00 ea.
- 1353236** Right side \$110.00 ea.
- 1353237** Left side \$75.00 ea.
- 1353277** Deck lid \$75.00 ea.

1963 Lark Regal 4-Door Sedan (Y4)

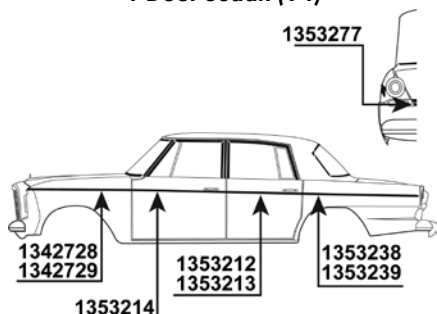

- 1342728** Right side \$75.00 ea.
- 1342729** Left side \$75.00 ea.
- 1353212** Right side \$45.00 ea.
- 1353213** Left side \$60.00 ea.
- 1353214** Either side \$45.00 ea.
- 1353238** Right side \$60.00 ea.
- 1353239** Left side \$60.00 ea.
- 1353277** Deck lid \$75.00 ea.

1963 Lark Custom 2-Door Sedan (F6)

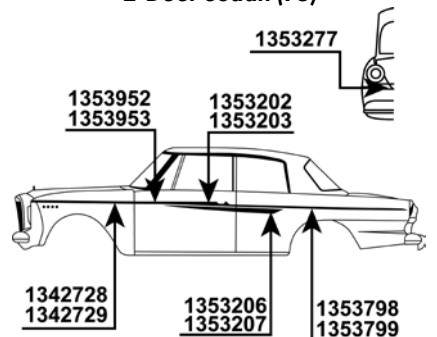

- 1342728** Right side \$75.00 ea.
- 1342729** Left side \$75.00 ea.
- 1353202** Right side \$150.00 ea.
- 1353203** Left side \$150.00 ea.
- 1353206** Right side \$45.00 ea.
- 1353207** Left side \$45.00 ea.
- 1353277** Deck lid \$75.00 ea.
- 1353798** Right side \$95.00 ea.
- 1353799** Left side \$110.00 ea.
- 1353952** Right side Call
- 1353953** Left side \$45.00 ea.

1963 Lark Custom 4-Door Sedan (Y6)

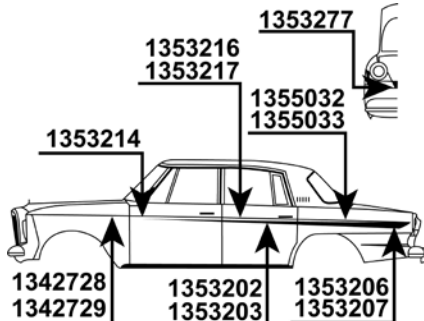

- 1342728** Right side \$75.00 ea.
- 1342729** Left side \$75.00 ea.
- 1353202** Right side \$150.00 ea.
- 1353203** Left side \$150.00 ea.
- 1353206** Right side \$45.00 ea.
- 1353207** Left side \$45.00 ea.
- 1353214** Either side \$45.00 ea.
- 1353216** Right side \$45.00 ea.
- 1353217** Left side \$45.00 ea.
- 1353277** Deck lid \$75.00 ea.
- 1355032** Right side \$64.00 ea.
- 1355033** Left side Call

1963 Cruiser 4-Door Sedan (Y8)

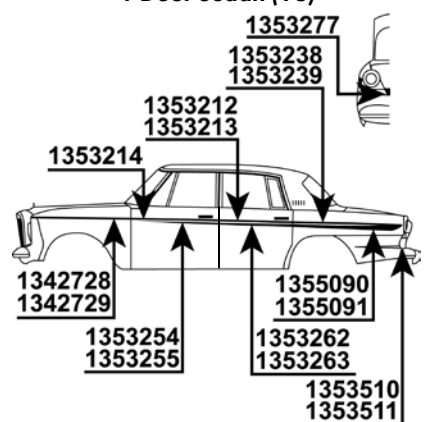

- 1342728** Right side \$75.00 ea.
- 1342729** Left side \$75.00 ea.
- 1353212** Right side \$45.00 ea.
- 1353213** Left side \$60.00 ea.
- 1353214** Either side \$45.00 ea.
- 1353238** Right side \$60.00 ea.
- 1353239** Left side \$60.00 ea.
- 1353254** Right side \$45.00 ea.
- 1353255** Left side Call
- 1353262** Right side \$45.00 ea.
- 1353263** Left side \$60.00 ea.
- 1353277** Deck lid \$75.00 ea.
- 1353510** Right side \$95.00 ea.
- 1353511** Left side Call
- 1355090** Right side \$75.00 ea.
- 1355091** Left side \$75.00 ea.

1963 Daytona 2-Door Hardtop (J8) & 2-Door Convertible (L8)

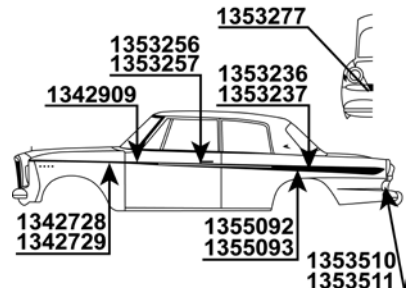

- 1342728** Right side \$75.00 ea.
- 1342729** Left side \$75.00 ea.
- 1342909** Either side \$45.00 ea.
- 1353236** Right side \$110.00 ea.
- 1353237** Left side \$75.00 ea.
- 1353256** Right side Call
- 1353257** Left side \$45.00 ea.
- 1353277** Deck lid \$75.00 ea.
- 1353510** Right side \$95.00 ea.
- 1353511** Left side Call
- 1355092** Right side Call
- 1355093** Left side Call

1963 Lark Regal 4-Door Wagon (P4)

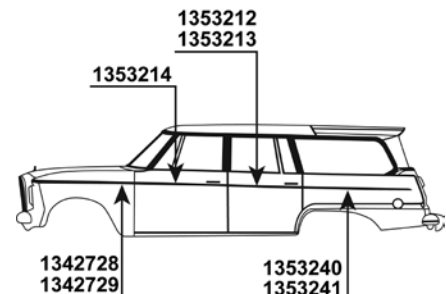

- 1342728** Right side \$75.00 ea.
- 1342729** Left side \$75.00 ea.
- 1353212** Right side \$45.00 ea.
- 1353213** Left side \$60.00 ea.
- 1353214** Either side \$45.00 ea.
- 1353240** Right side \$45.00 ea.
- 1353241** Left side \$45.00 ea.

1963 Daytona 4-Door Wagon (P8)

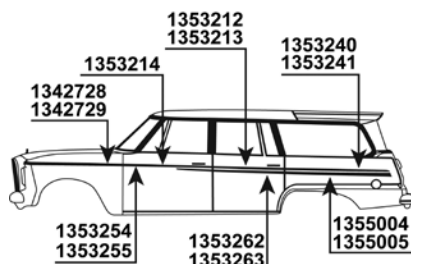

- 1342728** Right side \$75.00 ea.
- 1342729** Left side \$75.00 ea.
- 1353212** Right side \$45.00 ea.
- 1353213** Left side \$60.00 ea.
- 1353214** Either side \$45.00 ea.
- 1353240** Right side \$45.00 ea.
- 1353241** Left side \$45.00 ea.
- 1353254** Right side \$45.00 ea.
- 1353255** Left side Call
- 1353262** Right side \$45.00 ea.
- 1353263** Left side \$60.00 ea.
- 1355004** Right side \$60.00 ea.
- 1355005** Left side \$60.00 ea.

1964-65 Commander 2-Door Sedan (F4)

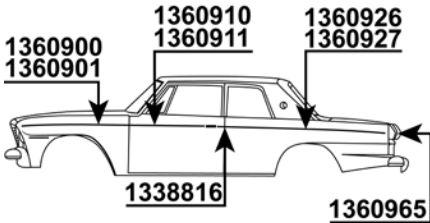

- 1338816** Either side \$5.00 ea.
- 1360900** Right side \$45.00 ea.
- 1360901** Left side \$45.00 ea.
- 1360910** Right side \$45.00 ea.
- 1360911** Left side \$45.00 ea.
- 1360926** Right side \$60.00 ea.
- 1360927** Left side \$60.00 ea.
- 1360965** Rear center Call

1964-65 Commander 4-Door Sedan (Y4)

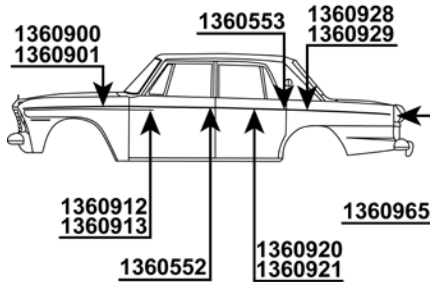

- 1360552** Either side \$7.25 ea.
- 1360553** Either side No Stock
- 1360900** Right side \$45.00 ea.
- 1360901** Left side \$45.00 ea.
- 1360912** Right side \$35.00 ea.
- 1360913** Left side \$35.00 ea.
- 1360920** Right side \$35.00 ea.
- 1360921** Left side \$35.00 ea.
- 1360928** Right side \$75.00 ea.
- 1360929** Left side \$60.00 ea.
- 1360965** Rear center Call

1964 Daytona 4-Door Sedan (Y8)

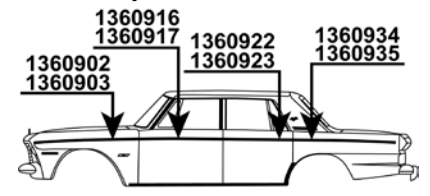

Rear Detail Illustration
 Note: 1360966, 1360965
 & 1360967 Fit All 1964
 Daytona Sedans

- 1360902** Right side Call
- 1360903** Left side Call

Note: 1360904 right and 1360905 left will substitute for 1360902 and 1360903. Will require stripping and repainting black.

- 1360916** Right side \$45.00 ea.
- 1360917** Left side \$45.00 ea.
- 1360922** Right side \$35.00 ea.
- 1360923** Left side \$35.00 ea.
- 1360934** Right side \$60.00 ea.
- 1360935** Left side \$45.00 ea.
- 1360965** Rear center Call
- 1360966** Upper \$40.00 ea.
- 1360967** Lower \$40.00 ea.

1964-65 Cruiser 4-Door Sedan (Y9)

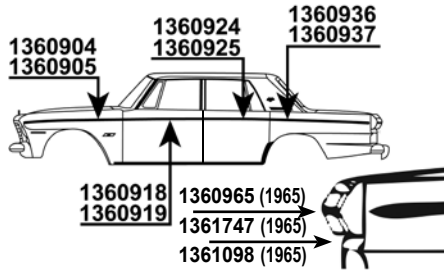

- 1358672** Trunk overlay without letters, 1964
 Cruiser (not shown) \$150.00 ea.
- 1360904** Right side \$75.00 ea.
- 1360905** Left side \$75.00 ea.
- 1360918** Right side \$45.00 ea.
- 1360919** Left side \$45.00 ea.
- 1360924** Right side Call
- 1360925** Left side Call
- 1360936** Right side \$60.00 ea.
- 1360937** Left side \$60.00 ea.
- 1360965** Rear center Call
- 1361098** Joiner \$5.00 ea.
- 1361747** Rear Call

1964 Daytona 2-Door Hardtop (J8) & Convertible (L8)

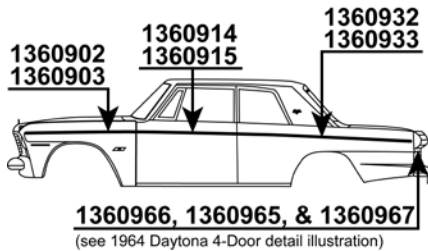

- 1360902** Right side Call
- 1360903** Left side Call
- Note: 1360904 right and 1360905 left will substitute for 1360902 and 1360903. Will require stripping and repainting black.
- 1360914** Right side \$75.00 ea.
- 1360915** Left side \$75.00 ea.
- 1360932** Right side \$85.00 ea.
- 1360933** Left side \$85.00 ea.
- 1360965** Rear center Call
- 1360966** Upper \$40.00 ea.
- 1360967** Lower \$40.00 ea.

1965 Daytona 4-Door Station Wagon

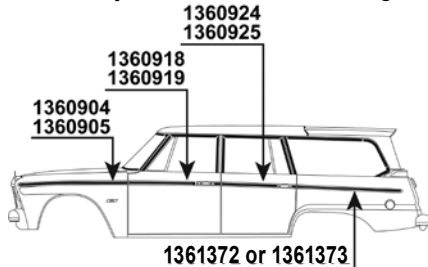

- 1360904** Right side \$75.00 ea.
- 1360905** Left side \$75.00 ea.
- 1360918** Right side \$45.00 ea.
- 1360919** Left side \$45.00 ea.
- 1360924** Right side Call
- 1360925** Left side Call
- 1361372** Right side \$75.00 ea.
- 1361373** Left side \$75.00 ea.

1964 Daytona 4-Door Wagon (P8)

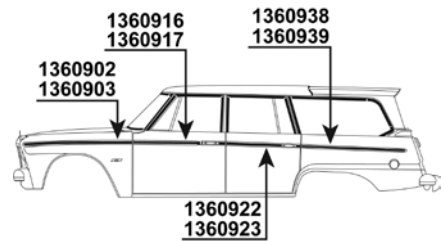

- 1360902** Right side Call
- 1360903** Left side Call
- Note: 1360904 right and 1360905 left will substitute for 1360902 and 1360903. Will require stripping and repainting black.
- 1360916** Right side \$45.00 ea.
- 1360917** Left side \$45.00 ea.
- 1360922** Right side \$35.00 ea.
- 1360923** Left side \$35.00 ea.
- 1360938** Right side \$45.00 ea.
- 1360939** Left side \$45.00 ea.

1964-65 Commander 4-Door Wagon (P4)

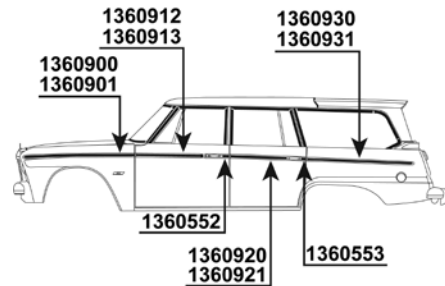

- 1360552** Either side \$7.25 ea.
- 1360553** Either side No Stock
- 1360900** Right side \$45.00 ea.
- 1360901** Left side \$45.00 ea.
- 1360912** Right side \$35.00 ea.
- 1360913** Left side \$35.00 ea.
- 1360920** Right side \$35.00 ea.
- 1360921** Left side \$35.00 ea.
- 1360930** Right side \$45.00 ea.
- 1360931** Right side \$45.00 ea.

1965 Daytona 2-Door Sedan (F8)

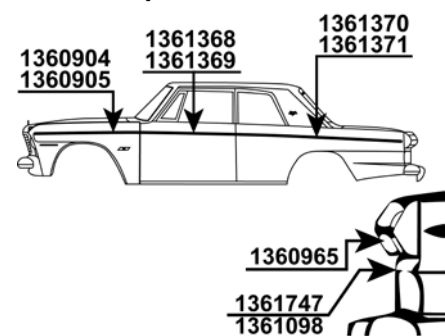

- 1360904** Right side \$75.00 ea.
- 1360905** Left side \$75.00 ea.
- 1360965** Rear center Call
- 1361098** Joiner \$5.00 ea.
- 1361368** Right side \$35.00 ea.
- 1361369** Right side \$35.00 ea.
- 1361370** Right side \$85.00 ea.
- 1361371** Left side \$85.00 ea.
- 1361747** Rear Call

1966 Commander 2-Door Sedan (F4)

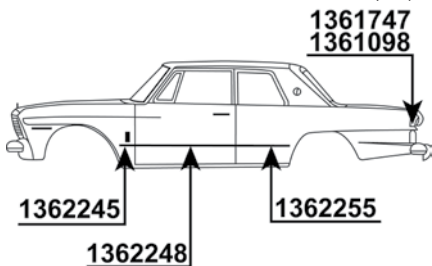

- 1361098** Joiner \$5.00 ea.
- 1361747** Lower, either side Call
- 1362245** Either side \$12.00 ea.
- 1362248** Either side \$45.00 ea.
- 1362255** Either side \$20.00 ea.

1966 Daytona 2-Door Sedan (F8)

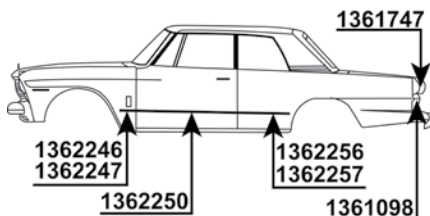

- 1361098** Joiner \$5.00 ea.
- 1361747** Lower, either side Call
- 1362246** Right side \$15.00 ea.
- 1362247** Left side \$20.75 ea.
- 1362250** Either side \$45.00 ea.
- 1362256** Right side \$25.00 ea.
- 1362257** Left side \$25.00 ea.

1966 Commander 4-Door Sedan & Station Wagon (Y4 & P8)

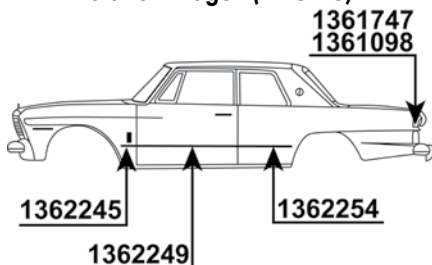

- 1361098** Joiner \$5.00 ea.
- 1361747** Lower, either side Call
- 1362245** Either side \$12.00 ea.
- 1362249** Either side \$45.00 ea.
- 1362254** Either side \$25.00 ea.

1966 Cruiser 4-Door Sedan (Y9)

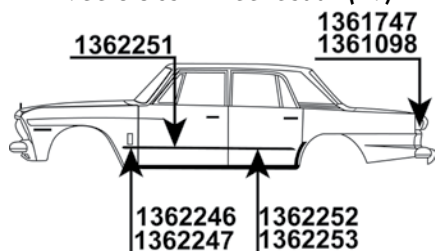

- 1361098** Joiner \$5.00 ea.
- 1361747** Lower, either side Call
- 1362246** Right side \$15.00 ea.
- 1362247** Left side \$20.75 ea.
- 1362251** Either side \$45.00 ea.
- 1362252** Right side \$25.00 ea.
- 1362253** Left side \$25.00 ea.

EMBLEM KITS

Early 1953 Champion C & K

297800WP "Studebaker" grille script.
.....\$50.00 ea.

297925V Trunk "S" emblem.
.....\$25.00 ea.

298675VP Paint-line Studebaker emblem (2).\$65.00 ea.

298746W Rear fender circled "S" emblem (2).\$40.00 ea.

303587V Hood "S" emblem (C & K).
.....\$25.00 ea.

306206WP "Champion" grille script.
.....\$50.00 ea.

Total of all parts listed if purchased separately.\$425.00

801814 Kit price\$399.00 kit.



**Early 1953
Commander C & K**

297800WP "Studebaker" grille script.
.....\$50.00 ea.

297926V Trunk "8" emblem.
.....\$25.00 ea.

298675VP Paint-line script (2).
.....\$65.00 ea.

299589W Trunk "Commander" script
.....\$40.00 ea.

303586WP Rear fender V-8 emblem (2).\$35.00 ea.

303588V Hood "8" emblem.
.....\$25.00 ea.

306207WP "Commander" grille script.
.....\$50.00 ea.

Total of all parts listed if purchased separately.\$450.00

801815 Kit price\$420.00 kit.



Tim Bergen's '50 Champion 2dr sedan with chauffeur, Sherman Oaks, CA

**Late 1953-1954
Champion C & K**

297800WP "Studebaker" grille script. \$50.00 ea.
298675VP Paint-line Studebaker script (2). \$65.00 ea.
298746W Rear fender circled "S" emblem (2). \$40.00 ea.
304823W "V" hood emblem. \$65.00 ea.
304825V "S" hood emblem. \$50.00 ea.
304829W Trunk "V" emblem. \$35.00 ea.
304830V Trunk "S" emblem. \$40.00 ea.
306206WP "Champion" grille script. \$50.00 ea.
Total of all parts listed if purchased separately. \$500.00
801135 Kit price..... \$470.00 kit.

**Late 1953-1954
Commander C & K**

297800WP "Studebaker" grille script. \$50.00 ea.	304829W Trunk "V" emblem. \$35.00 ea.
298675VP Paint-line script (2). \$65.00 ea.	304830V Trunk "S" emblem. \$40.00 ea.
299589W Trunk "Commander" script. \$40.00 ea.	306207WP "Commander" grille script. \$50.00 ea.
303586WP Rear fender V-8 emblem (2). \$35.00 ea.	1343241VP Trunk "8" emblem. \$35.00 ea.
304823W "V" hood emblem. \$65.00 ea.	304827VP Hood "8" emblem. \$65.00 ea.
Total of all parts listed if purchased separately. \$535.00	
801136 Kit price..... \$502.00 kit.	

1955 Speedster

297908 .Hood crest emblem insert. \$49.95	299444 Front fender plastic spear (2). \$25.00
304829W Deck lid "V" emblem. \$35.00	801675V "Speedster" script, Gold (2). \$50.00
1343241VP Deck lid "8" emblem. \$35.00	Total of all parts if purchased separately:\$269.95
801137 Special Kit Price \$253.00 kit.	

1956 Sky Hawk

800585 Plastic crest insert, trunk \$55.00 ea.	1312185W Hood ornament..... \$141.00 ea.
1314300W Studebaker script. Chrome. (2)..... \$35.00 ea.	1314307 Crest grille emblem..... \$85.00 ea.
1312439W Trunk lid emblem retainer \$45.00 ea.	1314765W Chrome "Hawk" script..... \$35.00 ea.
1314761W Chrome "Sky" script..... \$37.50 ea.	
Total of all parts if purchased separately. \$537.00	
801138 Kit price \$504.00 kit.	

**1956 Golden Hawk
(with chrome script)**

800585 Plastic crest insert, trunk. \$55.00	1314307 Crest grille emblem..... \$85.00 ea.
1312185W Hood ornament..... \$141.00 ea.	1314765W Chrome "Hawk" script. \$35.00 ea.
1312439W Trunk lid emblem retainer .. \$45.00 ea.	1314773W Chrome "Golden" script. \$34.95 ea.
1314300W Studebaker script, chrome (2). \$40.00 ea.	
Total of all parts if purchased separately..... \$534.45 ea.	
801139 Kit price \$502.00 kit.	

1956 Golden Hawk (with gold script)

800585 Plastic crest insert, trunk. \$55.00 ea.	1312185W Hood ornament. \$141.00 ea.
1312439W Trunk lid emblem retainer. \$45.00 ea.	1314307 Crest grille emblem. \$85.00 ea.
1314300V Gold "Studebaker" script (2). \$45.00 ea.	1314765V Gold "Hawk" script. \$40.00 ea.
1314773V Gold "Golden" script. \$34.95 ea.	Total of all parts listed if purchased separately. \$549.95
801139X1 Kit price \$516.00 kit.	

1957 Silver Hawk

1312185W Hood ornament. \$141.00 ea.	1314300W Studebaker script chrome (2). \$40.00 ea.
1314307 Crest grille emblem. \$85.00 ea.	1314765W "Hawk" script. \$35.00 ea.
1320940W "Silver" script. \$40.00 ea.	1320695 Crest trunk emblem. \$85.00 ea.
Total of all parts listed if purchased separately. \$524.50	
801140 Kit price \$493.00 kit.	

1957 Golden Hawk

1314300V Gold "Studebaker" script (2). \$45.00 ea.	800617W Fin louver (10). \$190.00 ea.
1314307 Crest grille emblem. \$85.00 ea.	1314765V Gold "Hawk" script. \$40.00 ea.
1314773V Gold "Golden" script. \$34.95 ea.	1320010V Hood "V" emblem. \$22.50 ea.
1320695 Crest trunk emblem. \$85.00 ea.	1320941V Gold bird emblem (2). \$22.00 ea.
1327014-5W Chrome roof Moulding. \$85.00 ea.	Total of all parts listed if purchased separately. \$676.45
801141 Kit price \$635.00 kit.	

1958 Silver Hawk

1312185W Hood ornament. \$141.00 ea.	1320695 Crest trunk emblem. \$85.00 ea.
1314300W Chrome "Studebaker" script (2). \$40.00 ea.	1320940W "Silver" script. \$40.00 ea.
1314765W "Hawk" script. \$35.00 ea.	1320941V Gold Bird emblem. \$22.00 ea.
Total of all parts listed if purchased separately. \$461.50	
801142 Total with 10% discount..... \$415.00 kit.	

1958 Golden Hawk

800617W Fin louver (10). \$190.00 ea.
1314765V Gold "Hawk" script. \$40.00 ea.
1320010V Hood "V" emblem. \$22.50 ea.
1320941V Gold bird emblem (3). \$22.00 ea.
1314300V Gold "Studebaker" script (2). \$45.00 ea.
1314773V Gold "Golden" script. \$34.95 ea.
1320695 Crest trunk emblem. \$85.00 ea.
1327014-5 Chrome roof Moulding. \$85.00 ea.
Total of all parts listed if purchased separately. \$613.45
801143 Kit price with 10% discount... \$576.00 kit.

1959 Silver Hawk

1312185W Hood ornament. \$141.00 ea.
1314300W "Studebaker" script. Chrome (2). \$40.00 ea.
1314765W "Hawk" script (2). \$35.00 ea.
1320430X10 "Studebaker" trunk letters. \$108.00 ea.
1320940W "Silver" script (2). \$40.00 ea.
1332218-9W Fin Moulding (2). \$75.00 ea.
1332238 Fin emblem (2). \$35.00 ea.
1332243 Grille emblem. Also 1959 wagon tailgate emblem \$40.00 ea.
Total of all parts listed if purchased separately. \$797.50
801144 Total with 10% discount..... \$749.00 kit.

1960-61 Hawk

1312185W Hood ornament. \$141.00 ea.	1314300W "Studebaker" script (2). \$40.00 ea.
1314765W "Hawk" script (2). \$35.00 ea.	1320430X10 "Studebaker" trunk letters. \$108.00 ea.
1332218-9W Fin Moulding (2). \$75.00 ea.	1337186 Grille emblem. \$40.00 ea.
1337188 Fin emblem (2). \$35.00 ea.	Total of all parts listed if purchased separately. \$717.50
801145 Total with 10% discount..... \$674.00 kit.	

1959 Lark VI

1314300W "Studebaker" script (3). \$40.00 ea.	1332235W "Lark" script (1). \$35.00 ea.
1332236W "VI" script. \$20.00 ea.	1332243 Grille emblem. Also 1959 wagon tailgate emblem. \$40.00 ea.
Total of all parts listed if purchased separately. \$215.00	
801146 Kit price \$202.00 kit.	

1959 Lark VIII

1314300W "Studebaker" script (3). \$40.00 ea.	1332235W "Lark" script (1). \$35.00 ea.
1332237W "VIII" script (1). \$25.00 ea.	1332243 Grille emblem. Also 1959 wagon tailgate emblem. \$40.00 ea.
Total of all parts listed if purchased separately. \$220.00	
801147 Kit price..... \$206.00 kit.	

1960 Lark VI

1314300W "Studebaker" script (1). \$40.00 ea.	1332235W "Lark" script (3). \$35.00 ea.
1332236W "VI" script (3). \$20.00 ea.	1336389WP Grille emblem. \$40.00 ea.
Total of all parts listed if purchased separately. \$245.00	
801148 Kit price \$230.00 kit.	

1960 Lark VIII

1314300W "Studebaker" script. \$40.00 ea.	1332235W "Lark" script (3). \$35.00 ea.
1336389WP Grille emblem. \$40.00 ea.	1332237W "VIII" script (3). \$25.00 ea.
Total of all parts listed if purchased separately. \$260.00	
801149 Kit price \$244.00 kit.	

1961 Lark VI

1314300W "Studebaker" script. \$40.00 ea.
1332235W "Lark" script (3). \$35.00 ea.
1332236W "VI" script (3). \$20.00 ea.
1338313W Grille emblem. \$40.00 ea.
Total of all parts listed if purchased separately. \$245.00
801150 Kit price \$230.00 kit.

1961 Lark VIII

1314300W "Studebaker" script. \$40.00 ea.
1332235W "Lark" script (3). \$35.00 ea.
1332237W "VIII" script (3). \$25.00 ea.
1338313W Grille emblem. \$40.00 ea.
Total of all parts listed if purchased separately. \$260.00
801151 Kit price..... \$244.00 kit.

1962 Lark 6-cylinder

304830V Deck lid "S" emblem, gold. \$40.00 ea.
1342775W Hood ornament. \$95.00 ea.
1343160X10 "Studebaker" trunk letters. \$108.00 ea.
1343230X8W "Lark" letters. \$70.00 ea.
1343240W Deck lid "V" emblem. \$35.00 ea.
1343246V Grille emblem. \$30.00 ea.
Total of all parts listed if purchased separately. \$383.00
801152 Kit price \$360.00 kit.

1962 Lark V-8

1342775W Hood ornament. \$95.00 ea.	1343160X10 "Studebaker" trunk letters. \$108.00 ea.
1343230X8 "Lark" letters. \$70.00 ea.	1343240W Deck lid "V" emblem. \$35.00 ea.
1343241VP Deck lid "8" emblem. \$35.00 ea.	1343246V Grille emblem. \$30.00 ea.
Total of all parts listed if purchased separately. \$283.00	
801153 Kit price \$266.00 kit.	

1963 Lark 6-cylinder

1342775W Hood ornament. \$95.00 ea.	1343160X10 "Studebaker" trunk letters. \$108.00 ea.
1343230X8 "Lark" letters. \$70.00 ea.	1353370W Deck lid emblem retainer ring. \$39.00 ea.
1353372 Deck lid plastic. \$40.00 ea.	1355042 Grille emblem. \$45.00 ea.
Total of all parts listed if purchased separately. \$302.00	
801154 Kit price \$283.00 kit.	

1963 GT Hawk

801857 Front spear assembly. \$175.00 pr.
1343546V Gold "Gran Turismo" script (2). \$45.00 ea.
1353371 Deck lid plastic insert. \$75.00 ea.
1353735V Gold door chevron (2). \$35.00 ea.
1320941V Gold bird emblem (2). \$22.00 ea.
1353370W Deck lid emblem retainer ring. \$39.00 ea.
1353530W Grille emblem. \$45.00 ea
Total of all parts listed if purchased separately. \$568.00 ea.
801158 Total with 10% discount..... \$533.00 kit.

1965 Cruiser

1358204W Fender emblem "8" (2). \$40.00 ea.
1358580W Hood ornament. \$65.00 ea.
1360490W "Studebaker" script. \$45.00 ea.
1360494W "Cruiser" script (3). \$30.00 ea.
Total of all parts listed if purchased separately. \$280.00
801155 Kit price \$263.00 kit.

1965 Daytona

1358204W Fender emblem "8" (2). \$40.00 ea.
1358580W Hood ornament. \$65.00 ea.
1360490W "Studebaker" script. \$45.00 ea.
1360493W "Daytona" script (3). \$35.00 ea.
Total of all parts listed if purchased separately. \$295.00
801156 Kit price \$277.00 kit.

1964 GT Hawk

801857 Front spear assembly. \$175.00 pr.
1353370W Deck lid emblem retainer ring. \$39.00 ea.
1353371 Deck lid plastic insert. \$75.00 ea.
1358580W Hood ornament. \$65.00 ea.
1360155W Chrome door chevron (2). \$35.00 ea.
1360160W Chrome "Gran Turismo" script (2). \$55.00 ea.
1360162W Chrome bird emblem (2). \$20.00 ea.
1360164W Grille emblem. 1964 Hawk. \$50.00 ea.
1360490W "Studebaker" script. \$45.00 ea.
1360495W "Hawk" script. \$30.00 ea.
Total of all parts listed if purchased separately. \$743.00
801159 Total with 10% discount..... \$698.00 kit.

1962 GT Hawk

1320941V Gold bird emblem (3). \$22.00 ea.	1343546V Gold "Gran Turismo" script (2). \$45.00 ea.
1343548W Trunk emblem retaining ring \$35.00 ea.	1343590 Front fender spear (2). \$20.00 ea.
1355125W Front spear Moulding (2). \$40.00 ea.	Total of all parts listed if purchased separately. \$311.00
801157 Kit price \$292.00 kit.	

1963 Avanti R-1

1314300W "Studebaker" script. \$40.00 ea.	1351167W Plastic insert (2), rear quarter. \$39.95 ea.
1351153W Chrome retainer (2), rear quarter. \$35.00 ea.	1351226W Hood ornament. \$125.00 ea.
1351155W "Avanti" script. \$40.00 ea.	1358747W Plastic hood insert. Please specify gold or chrome "S". \$49.00 ea.
Total of all parts listed if purchased separately. \$403.90	
801160R Total with 10% discount \$379.00 kit.	

1963 Avanti R-2

1314300W "Studebaker" script. \$40.00 ea.	1351155W "Avanti" script. \$40.00 ea.
1350498 "Supercharged" emblem (2). \$25.00 ea.	1351167W Plastic insert (2), rear quarter. \$39.95 ea.
1351153W Chrome retainer (2), rear quarter. \$35.00 ea.	1351226W Hood ornament. \$125.00 ea.
1358747W Plastic hood insert. Please specify gold or chrome "S". \$49.00 ea.	Total of all parts listed if purchased separately. \$453.90 ea.
801161R Kit price \$426.00 kit.	

1964 Avanti R-1

1314300W "Studebaker" script. \$40.00 ea.	1351153W Chrome retainer (2), rear quarter. \$35.00 ea.
1351155W "Avanti" script. \$40.00 ea.	1351167W Plastic insert (2), rear quarter. \$39.95 ea.
1351226W Hood ornament. \$125.00 ea.	1358747W Plastic hood insert. \$49.00 ea.
Total of all parts listed if purchased separately. \$403.90	
801162R Kit price \$379.00 kit.	

1964 Avanti R-2

1314300W "Studebaker" script. \$40.00 ea.	1351153W Chrome retainer (2), rear quarter. \$35.00 ea.
1351155W "Avanti" script. \$40.00 ea.	1351167W Plastic insert (2), rear quarter. \$39.95 ea.
1351226W Hood ornament. \$125.00 ea.	1358726W "Supercharged" emblem (2). \$40.00 ea.
1358747W Plastic hood insert. \$49.00 ea.	Total of all parts listed if purchased separately. \$483.90
801163R Kit price \$454.00 kit.	

1956 Flight Hawk

800585 Plastic crest insert, trunk. \$55.00 ea.
1312439W Trunk lid emblem retainer. \$45.00 ea.
1314307 Crest grille emblem. \$85.00 ea.
1314763W Chrome "Flight" script. \$45.00 ea.
1314765W Chrome "Hawk" script. \$35.00 ea.
1312185W Hood ornament. \$141.00 ea.
1314300W Studebaker script. Chrome. (2) \$40.00 ea.
Total of all parts listed if purchased separately. \$544.50 ea.
801435 Kit price \$511.00 kit.

1964 Daytona

1320133WP V-8 roof emblem (2). \$38.00 ea.
1320430X10 Studebaker trunk letters. \$108.00 ea.
1358204W Fender emblem "8" (2). \$40.00 ea.
1358580W Hood ornament. \$65.00 ea.
1360493W "Daytona" script (2). \$35.00 ea.
Total of all parts listed if purchased separately. \$403.00 ea.
801709 Kit price \$378.00 kit.

1956 Power Hawk

800585 Plastic crest insert, trunk.
.....**\$55.00 ea.**

1312185W Hood ornament.
.....**\$141.00 ea.**

1312439W Trunk lid emblem.
.....**\$45.00 ea.**

1314300W Studebaker script.
Chrome. (2).**\$40.00 ea.**

1314307 Crest grille emblem.
.....**\$85.00 ea.**

1314765W Chrome "Hawk" script.
.....**\$35.00 ea.**

1314774W Chrome "Power" script.
.....**\$47.50 ea.**

Total of all parts listed if purchased
separately.**\$552.00 ea.**

801436 Kit price**\$518.00 kit.**

1963 Lark V-8

1342775W Hood ornament.
.....**\$95.00 ea.**

1343230X8W "Lark" letters.
.....**\$70.00 ea.**

1355043 Grille emblem.
.....**\$45.00 ea.**

1343160X10 "Studebaker" trunk
letters.**\$108.00 ea.**

1353370W Deck lid emblem
retainer ring.**\$39.00 ea.**

1353373 Deck lid plastic.
.....**\$75.00 ea.**

Total of all parts listed if purchased
separately.**\$432.00 ea.**

801527 Kit price**\$406.00 kit.**

BRIGHTWORKS PACKAGES

1963 Avanti R-1

AC-3310 Outside mirrors (2).
.....**\$120.00 ea.**

AC-3339 Chrome exhaust tips (2).
.....**\$65.00 ea.**

1314300W "Studebaker" script.
.....**\$40.00 ea.**

1350534W H/L ring, right.
.....**\$149.95 ea.**

1351155W "Avanti" script.
.....**\$40.00 ea.**

1358747W Plastic hood insert.
.....**\$49.00 ea.**

1350397 H/L lens gasket (2).
.....**\$19.00 ea.**

1351033 Wiper arm, stainless (2).
.....**\$39.50 ea.**

1351167W Plastic insert (2), rear
quarter.**\$39.95 ea.**

800203 Well nut (2).**\$5.00 pr.**

1350533W H/L ring, left.
.....**\$149.95 ea.**

1351153W Chrome retainer (2),
rear quarter.**\$35.00 ea.**

1351226W Hood ornament.
.....**\$125.00 ea.**

Total of all parts listed if purchased separately
.....**\$1,200.80**

Special Kit Price**\$1,125.00**
-10% quantity discount. See page 6...**\$112.50**

801164R Your Price. Please specify
gold or chrome "S"**\$1,012.50 kit**

1964 Commander V-8

1320430X10 Studebaker trunk
letters.**\$108.00 ea.**

1358580W Hood ornament.
.....**\$65.00 ea.**

1360489W "Commander" script (2).
.....**\$55.00 ea.**

1358204W Fender emblem "8".
.....**\$40.00 ea.**

1360150W Roof emblem (2).
.....**\$30.00 ea.**

Total of all parts listed if purchased
separately.**\$383.00 ea.**

801710 Kit price**\$360.00 kit.**

1965 Commander V-8

1358204W Fender emblem "8" (2).
.....**\$40.00 ea.**

1360150W Roof emblem (2).
.....**\$30.00 ea.**

1360490W "Studebaker" script.
.....**\$45.00 ea.**

1358580W Hood ornament.
.....**\$65.00 ea.**

1360489W "Commander" script (3).
.....**\$30.00 ea.**

Total of all parts listed if purchased
separately.**\$355.00 ea.**

801711 Kit price**\$333.00 kit.**

RETURNING PARTS?

**Do not forget a copy of your
invoice with your return!**

There is a **\$5.00** "Invoice Search" fee
for items returned without an invoice.



1963 Avanti R-2

AC-3310 Outside mirrors (2). \$120.00 ea.	AC-3339 Chrome exhaust tips (2). \$65.00 ea.	800203 Well nut (2). \$5.00 pr.
1314300W "Studebaker" script. \$40.00 ea.	1350397 H/L lens gasket (2). \$19.00 ea.	1350498 "Supercharged" emblem (2). \$25.00 ea.
1350533W H/L ring, left. \$149.95 ea.	1350534W H/L ring, right. \$149.95 ea.	1351033 Wiper arm, stainless (2). \$39.50 ea.
1351153W Chrome retainer (2), rear quarter. 35.00 ea.	1351155W "Avanti" script. \$40.00 ea.	1351167W Plastic insert (2), rear quarter. 39.95 ea.
1351226W Hood ornament. \$125.00 ea.	1351167W Plastic insert (2), rear quarter. 39.95 ea.	1358747W Plastic hood insert. \$49.00 ea.
Total of all parts listed if purchased separately.....		\$1,250.80
Special Kit Price		\$1,175.00
-10% quantity discount.. See page 6.....		\$117.50
801165R Your Price. Please specify gold or chrome "S"		1,057.50 kit

1964 Avanti R-1

AC-3310 Outside mirrors (2). \$120.00 ea.	AC-3339 Chrome exhaust tips (2). \$65.00 ea.	800203 Well nut (2). \$5.00 pr.
1314300W "Studebaker" script. \$40.00 ea.	1351033 Wiper arm, stainless (2). \$39.50 ea.	1351153W Chrome retainer (2), rear quarter. \$35.00 ea.
1351155W "Avanti" script. \$40.00 ea.	1351167W Plastic insert (2), rear quarter. \$39.95 ea.	1351226W Hood ornament. \$125.00 ea.
1358720 P/L assembly (2). \$295.00 ea.	1358747W Plastic hood insert. \$49.00 ea.	1358787 H/L lens gasket (2). \$12.50 ea.
1358849W H/L ring (2). \$150.00 ea.	Total of all parts listed if purchased separately.....\$1,777.90	
Special Kit Price		\$1,670.00
-15% quantity discount.. See page 6.....		\$250.50
801166R Your Price. Please specify gold or chrome "S"		\$1,419.50 kit

1964 Avanti R-2

AC-3310 Outside mirrors (2). \$120.00 ea.	AC-3339 Chrome exhaust tips (2). \$65.00 ea.	1314300W "Studebaker" script. \$40.00 ea.
1351033 Wiper arm, stainless (2). \$39.50 ea.	1351153W Chrome retainer (2), rear quarter. \$35.00 ea.	1351155W "Avanti" script. \$40.00 ea.
800203 Well nut (2). \$5.00 pr.	1351167W Plastic insert (2), rear quarter. \$39.95 ea.	1351226W Hood ornament. \$125.00 ea.
1358720 P/L assembly (2). \$295.00 ea.	1358726W "Supercharged" emblem (2). \$40.00 ea.	1358747W Plastic hood insert. \$49.00 ea.
1358787 H/L lens gasket (2). \$12.50 ea.	1358849W H/L ring, (2). \$150.00 ea.	Total of all parts listed if purchased separately. \$1,857.90
Special Kit Price		\$1,745.00
-15% quantity discount.. See page 6.....		\$261.75
801167R Your Price. Please specify gold or chrome "S"		\$1,483.25 kit

1962 G T Hawk

AC-2704 Gas filler guard. \$39.95 ea.	AC-2840 Exhaust deflector. \$119.95 ea.	AC-2918 or AC-3310 Outside mirrors (2). \$120.00 ea.
29-015 Valve stem caps. \$5.95 set 4.	287693W Chrome nut wiper pivot (2). \$4.95 ea.	298300 Leather gasket, wiper pivot (2). \$3.50 ea.
298301W Escutcheon, wiper pivot. Chrome (2). \$18.00 ea.	524972X1 Oval bumper bolt with nut and washer (8). \$6.95 set.	1312088W Headlight rims (2). \$123.50 ea.
1314802 Stainless wiper arms. \$25.00 ea.	1314803 Stainless wiper arms. \$25.00 ea.	1314810B Stainless wiper blades (2). \$19.95 ea.
1320941V Gold bird emblem (3). \$22.00 ea.	1343546V Gold "Gran Turismo" script (2). \$45.00 ea.	1343548W Trunk emblem retaining ring \$35.00 ea.
1343590 Front plastic fender spear insert (2). \$20.00 ea.	1355125W Front spear Moulding. Chrome (2). \$40.00 ea.	1360980 Outer chrome door handles (2). \$65.00 ea.
1343706W Right rear fender Moulding insert. Chrome. \$55.00 ea.	1343707W Left rear fender Moulding insert. Chrome. \$55.00 ea.	1541696 Round head bumper bolts (4). \$2.50 ea.
Total of all parts listed if purchased separately..... \$1,559.65		
Special Kit Price \$1,465.00		
-10% quantity discount.. See page 6..... \$146.50		
801610 Your Price \$1,318.50 kit		

1963 G.T. Hawk

AC-2704 Gas filler guard. \$39.95 ea.	AC-2840 Exhaust deflector. \$119.95 ea.	AC-2918 or AC-3310 Outside mirrors (2). \$120.00 ea.
29-015 Valve stem caps. \$5.95 set 4.	287693W Chrome nut wiper pivot (2). \$4.95 ea.	298300 Leather gasket, wiper pivot (2). \$3.50 ea.
298301W Escutcheon, wiper pivot. Chrome (2). \$18.00 ea.	524972X1 Oval bumper bolt with nut and washer (8). \$6.95 set.	801857 Front spear assembly. \$175.00 pr.
1314810B Stainless wiper blades (2). \$19.95 ea.	1314802 Stainless wiper arms. \$25.00 ea.	1314803 Stainless wiper arms. \$25.00 ea.
1320941V Gold bird emblem (2). \$22.00 ea.	1343546V Gold "Gran Turismo" script (2). \$45.00 ea.	1353370W Deck lid emblem retainer ring. \$39.00 ea.
1353371 Deck lid plastic insert. \$75.00 ea.	1343706W Right rear fender Moulding insert. Chrome. \$55.00 ea.	1343707W Left rear fender Moulding insert. Chrome. \$55.00 ea.
1353530W Grille emblem. \$45.00 ea.	1353535W Center grille mesh. \$85.00 ea.	1353735V Gold door chevron (2). \$35.00 ea.
1360980 Outer chrome door handles (2). \$65.00 ea.	1541696 Round head bumper bolts (4). \$2.50 ea.	Total of all parts listed if purchased separately. \$1,706.65
Special Kit Price \$1,600.00		
-15% quantity discount.. See page 6..... \$240.00		
801611 Your Price \$1,360.00 kit		

1964 G.T Hawk

AC-2704 Gas filler guard.\$ 39.95 ea.	AC-2840 Exhaust deflectors (2).\$ 119.95 ea.	AC-2918 or AC-3310 Outside mirrors (2).\$ 120.00 ea.
29-015 Valve stem caps.\$ 5.95 set 4.	287693W Chrome nut wiper pivot (2).\$ 4.95 ea.	298300 Leather gasket, wiper pivot (2).\$ 3.50 ea.
298301W Escutcheon, wiper pivot. Chrome (2).\$ 18.00 ea.	524972X1 Oval bumper bolt with nut and washer (8).\$ 6.95 set.	801857 Front spear assembly.\$ 175.00 pr.
1314810B Stainless wiper blades (2).\$ 19.95 ea.	1314802 Stainless wiper arms.\$ 25.00 ea.	1314803 Stainless wiper arms.\$ 25.00 ea.
1343706W Right rear fender Moulding insert. Chrome.\$ 55.00 ea.	1343707W Left rear fender Moulding insert. Chrome.\$ 55.00 ea.	1353370W Deck lid emblem retainer ring.\$ 39.00 ea.
1353371 Deck lid plastic insert.\$ 75.00 ea.	1358580W Hood ornament.\$ 65.00 ea.	1360155W Chrome door chevron (2).\$ 35.00 ea.
1360160W Chrome "Gran Turismo" script (2).\$ 55.00 ea.	1360162W Chrome bird emblem (2).\$ 20.00 ea.	1360164W Grille emblem.\$ 50.00 ea.
1360490W "Studebaker" script.\$ 45.00 ea.	1360495W "Hawk" script.\$ 30.00 ea.	1360980 Outer chrome door handles (2).\$ 65.00 ea.
1541696 Round head bumper bolts (4).\$ 2.50 ea.	Total of all parts listed if purchased separately.....\$1,744.65	
	Special Kit Price \$ 1,635.00	
	-15% quantity discount.. See page 6..... \$245.25	
801612 Your Price		\$ 1,389.75 kit.

Early 1953 Champion C & K

AC-2704 Gas filler guard.\$ 39.95 ea.	AC-2340 or AC-2728 Outside mirrors (2)..... \$ 105.00 ea.
29-015 Valve stem caps.\$ 5.95/set 4.	296915X2B Stainless wiper blades (2).....\$ 19.95 ea.
287693W Chrome nut wiper pivot (2). ...\$ 4.95 ea.	298746W Rear fender circled "S" emblem (2).\$ 40.00 ea.
297925V Trunk "S" emblem \$ 25.00 ea.	297800WP "Studebaker" grille script.\$ 50.00 ea.
298300 Leather gasket, wiper pivot (2). \$ 3.50 ea.	298301W Escutcheon, wiper pivot, Chrome (2).\$ 18.00 ea.
298316 Outside door handle buttons (2).\$ 22.25 ea.	298319 Outside door handle spring (2).\$ 3.50 ea.
298675VP Paint-line Studebaker emblem (2).\$ 65.00 ea.	303587V Hood "S" emblem.\$ 25.00 ea.
306206WP "Champion" grille script.\$ 50.00 ea.	524972X1 Oval bumper bolt with nut and washer (8).....\$ 6.95 set.
1312088W Headlight rims (2).\$ 123.50 ea.	Total of all parts listed if purchased separately \$1,251.20
Special Kit Price \$ 1,185.00	
-10% quantity discount.. See page 6.....	\$118.50
801948 Your Price\$ 1,066.50 kit	

Late 1953 - All 54 Champion C & K

AC-2704 Gas filler guard.\$ 39.95 ea.	AC-2340 or AC-2728 Outside mirrors (2)..... \$ 105.00 ea.
29-015 Valve stem caps.\$ 5.95/set 4.	287693W Chrome nut wiper pivot (2). ...\$ 4.95 ea.
296915X2B Stainless wiper blades (2).....\$ 19.95 ea.	297800WP "Studebaker" grille script.\$ 50.00 ea.
298300 Leather gasket, wiper pivot (2). ...\$ 3.50 ea.	298301W Escutcheon, wiper pivot, Chrome (2).\$ 18.00 ea.
298316 Outside door handle buttons (2).....\$ 22.25 ea.	298319 Outside door handle spring (2).\$ 3.50 ea.
298675VP Paint-line Studebaker emblem (2).\$ 65.00 ea.	298746W Rear fender circled "S" emblem (2).\$ 40.00 ea.
304823W Hood "V" emblem.\$ 65.00 ea.	304829W Trunk "V" emblem.\$ 35.00 ea.
304830V Trunk "S" emblem.\$ 40.00 ea.	306206WP "Champion" grille script.\$ 50.00 ea.
524972X1 Oval bumper bolt with nut and washer (8).\$ 6.95 set.	1312088W Headlight rims (2).\$ 123.50 ea.
Total of all parts listed if purchased separately.....\$1,276.20	
Special Kit Price \$ 1,210.00	
-10% quantity discount.. See page 6..... \$121.00	
801949 Your Price\$ 1,089.00 kit	

Early 1953 Commander C & K

AC-2340 or AC-2728 Outside mirrors (2).**\$105.00 ea.**

287693W Chrome nut wiper pivot.**\$4.95 set 4.**

297800WP "Studebaker" grille script.....**\$50.00 ea.**

297926V Trunk "8" emblem**\$25.00 ea.**

298301W Escutcheon, wiper pivot, Chrome (2)**\$18.00 ea.**

298319 Outside Door Handle buttons (2).....**\$3.50 ea.**

299589W Trunk "Commander" script **\$40.00 ea.**

303588V Hood "8" emblem.**\$25.00 ea.**

524972X1 Oval bumper bolt with nut & washer (8).**\$6.95 set.**

AC-2704 Gas filler guard.**\$39.95 ea.**

29-015 Valve stem caps.**\$5.95 set 4**

296915X2B Stainless wiper blades (2)**\$19.95 ea.**

298300 Leather gasket, wiper pivot (2)**\$3.50 ea.**

298316 Outside Door Handle buttons (2) **\$22.25 ea.**

298675VP Paintline Studebaker emblem (2) **\$65.00 ea.**

303586WP Rear fender "V-8" emblem (2).....**\$35.00 ea.**

306207WP "Commander" grille script.**\$50.00 ea.**

1312088W Headlight rims (2).**\$123.50 ea.**

Total of all parts listed if purchased separately \$1,276.20

Special Kit Price**\$1,210.00**
-10% quantity discount.. See page 6.....
.....**\$121.00**

801950 Your Price.....**\$1,089.00 kit**

Late 1953-54 Champion C & K

AC-2704 Gas filler guard.**\$39.95 ea.**

29-015 Valve stem caps.**\$5.95/set 4.**

296915X2B Stainless wiper blades (2).**\$19.95 ea.**

298300 Leather gasket, wiper pivot (2) **\$3.50 ea.**

298316 Outside door handle buttons (2).**\$22.25 ea.**

298675VP Paint-line Studebaker emblem (2).**\$22.25 ea.**

304823W Hood "V" emblem.**\$65.00 ea.**

304827VP Trunk "S" emblem.**\$65.00 ea.**

524972X1 Oval bumper bolt with nut and washer (8).**\$6.95 set.**

1343241VP Trunk "8" emblem.**\$35.00 ea.**

Special Kit Price**\$1,340.00**
-10% quantity discount.. See page 6.....**\$134.00**

801951 Your Price.....**\$1,206.00 kit**

AC-2340 or AC-2728 Outside mirrors (2).**\$105.00 ea.**

287693W Chrome nut wiper pivot (2).**\$4.95 ea.**

297800WP "Studebaker" grille script.**\$50.00 ea.**

298301W Escutcheon, wiper pivot, Chrome (2).**\$18.00 ea.**

298319 Outside door handle spring (2) **\$3.50 ea.**

299589W Trunk "Commander" script.**\$40.00 ea.**

304829W Trunk "V" emblem.**\$35.00 ea.**

306207WP "Commander" grille script.....**\$50.00 ea.**

1312088W Headlight rims (2).**\$123.50 ea.**

Total of all parts listed if purchased separately \$1,413.20

1955 Champion C & K

AC-2704 Gas filler guard.**\$39.95 ea.**

29-015 Valve stem caps.**\$5.95 set 4.**

296915X2B Stainless wiper blades (2).**\$19.95 ea.**

298301W Escutcheon, wiper pivot. Chrome (2).**\$18.00 ea.**

298319 Outside door handle spring (2).**\$3.50 ea.**

304830V Trunk "S" emblem.**\$40.00 ea.**

524972X1 Oval bumper bolt with nut and washer (8).**\$6.95 set.**

Total of all parts listed if purchased separately \$1,423.20

Special Kit Price **\$1,350.00**
-10% quantity discount.. See page 6.....**\$135.00**

801952 Your Price..... **\$1,215.00 kit**

AC-2340 or AC-2728 Outside mirrors (2).**\$105.00 ea.**

287693W Chrome nut wiper pivot (2).**\$4.95 ea.**

298300 Leather gasket, wiper pivot (2).**\$3.50 ea.**

298316 Outside door handle buttons (2).**\$22.25 ea.**

304829W Trunk "V" emblem.**\$35.00 ea.**

1312088W Headlight rims (2).**\$123.50 ea.**

1955 Commander C & K

AC-2340 or AC-2728 Outside mirrors (2).**\$105.00 ea.**

287693W Chrome nut wiper pivot (2).**\$4.95 ea.**

298300 Leather gasket, wiper pivot (2).**\$3.50 ea.**

298316 Outside door handle buttons (2).**\$22.25 ea.**

299444 Front fender ornament plastic insert (2).**\$25.00 ea.**

304829W Trunk "V" emblem.**\$35.00 ea.**

308910W "Commander" rear fender script (2).**\$35.00 ea.**

1312088W Headlight rims (2).**\$123.50 ea.**

AC-2704 Gas filler guard.**\$39.95 ea.**

29-015 Valve stem caps.**\$5.95 set 4.**

296915X2B Stainless wiper blades (2).**\$19.95 ea.**

298301W Escutcheon, wiper pivot. Chrome (2).**\$18.00 ea.**

298319 Outside door handle spring (2)**\$3.50 ea.**

299589W Trunk "Commander" script.**\$40.00 ea.**

524972X1 Oval bumper bolt with nut and washer (8).**\$6.95 set.**

1343241VP Trunk "8" emblem.**\$35.00 ea.**

Total of all parts listed if purchased separately with 1 exhaust..... \$1,476.20
Special Kit Price**\$1,400.00**
-10% quantity discount.. See page 6 ...\$140.00

801953 Your Price w/1 exhaust.....**\$1,260.00 kit**

Total of all parts listed if purchased separately with 2 exhausts..... \$1,576.15
Special Kit Price**\$1,495.00**
-10% quantity discount.. See page 6 ...\$149.50

801953X1 Your Price w/2 exhausts..**\$1,345.50 kit**

1955 President C & K

AC-2704 Gas filler guard.**\$39.95 ea.**

29-015 Valve stem caps.**\$5.95 set 4.**

296915X2B Stainless wiper blades (2).**\$19.95 ea.**

298300 Leather gasket, wiper pivot (2).**\$3.50 ea.**

298316 Outside door handle buttons (2).**\$22.25 ea.**

304829W Trunk "V" emblem.**\$35.00 ea.**

308911V "President" script for rear fenders (2).**\$40.00 ea.**

1312088W Headlight rims (2).**\$123.50 ea.**

AC-2340 or AC-2728 Outside mirrors (2).**\$105.00 ea.**

287693W Chrome nut wiper pivot (2).**\$4.95 ea.**

299444 Front fender ornament plastic insert (2).**\$25.00 ea.**

298301W Escutcheon, wiper pivot. Chrome (2).**\$18.00 ea.**

298319 Outside door handle spring (2).**\$3.50 ea.**

304829W Trunk "V" emblem.**\$35.00 ea.**

524972X1 Oval bumper bolt with nut and washer (8).**\$6.95 set.**

1343241VP Trunk "8" emblem.**\$35.00 ea.**

Total of all parts listed if purchased separately with 1 exhaust..... \$1,498.20
Special Kit Price**\$1,420.00**
-10% quantity discount.. See page 6..... \$142.00

801954 Your Price w/1 exhaust.....**\$1,278.00 kit**

Total of all parts listed if purchased separately with 2 exhausts \$1,598.15
Special Kit Price**\$1,515.00**
-15% quantity discount.. See page 6..... \$227.25

801954X1 Your Price w/2 exhausts**\$1,287.75 kit**

1955 Speedster K

AC-2704 Gas filler guard.....**\$45.00 ea.**

29-015 Valve stem caps.**\$5.95 set 4.**

296915X2B Stainless wiper blades (2).**\$19.95 ea.**

298300 Leather gasket, wiper pivot (2).**\$3.50 ea.**

298316 Outside door handle buttons (2).**\$22.25 ea.**

299444 Front fender ornament plastic insert (2).**\$25.00 ea.**

801675V "Speedster" script (2).**\$50.00 ea.**

1343241VP Trunk "8" emblem.**\$35.00 ea.**

Total of all parts listed if purchased separately..... \$1,688.10
Special Kit Price**\$1,600.00**
-15% quantity discount.. See page 6..... \$240.00

801955 Your Price.....**\$1,360.00 kit**

AC-2340 or AC-2728 Outside mirrors (2)**\$105.00 ea.**

287693W Chrome nut wiper pivot (2).**\$4.95 ea.**

297908 Hood crest emblem insert.**\$49.95 ea.**

298301W Escutcheon, wiper pivot. Chrome (2).**\$18.00 ea.**

298319 Outside door handle spring (2)**\$3.50 ea.**

304829W Trunk "V" emblem.**\$35.00 ea.**

524972X1 Oval bumper bolt with nut and washer (8).....**\$6.95 set.**

1312088W Headlight rims (2).**\$123.50 ea.**

1956 Flight Hawk

Single Exhaust

Includes all parts in basic kit plus:

1314763W "Flight" script.
.....\$45.00 ea.

1314300W "Studebaker" script (2).
.....\$40.00 ea.

1314765W "Hawk" script.
.....\$35.00 ea.

Total of all parts listed if purchased separately...\$1,899.75

Special Kit Price\$1,785.00

-15% quantity discount.. See page 6..\$267.75

801956 Your Price.....\$1,517.25 kit

1956 Power Hawk

Single Exhaust

Includes all parts in basic kit plus:

1314300W "Studebaker" script (2).
.....\$40.00 ea.

1314774W "Power" script. N.O.S.
.....\$47.50 ea.

1314765W "Hawk" script.
.....\$35.00 ea.

Total of all parts listed if purchased separately...\$1,894.25

Special Kit Price\$1,780.00

-15% quantity discount.. See page 6. \$267.00

801957 Your Price.....\$1,513.00 kit

1956 Sky Hawk

Single Exhaust

Includes all parts in basic kit plus:

1314765W "Hawk" script.
.....\$35.00 ea.

1314300W "Studebaker" script (2).
.....\$40.00 ea.

1314761W "Sky" script.
.....\$37.50 ea.

Total of all parts listed if purchased separately...\$1,884.25

Special Kit Price\$1,770.00

-15% quantity discount.. See page 6. \$265.50

801958 Your Price.....\$1,504.50 kit

1956 Golden Hawk

(Chrome Script/Dual Exhaust)

Includes all parts in basic kit plus:

AC-2754 Exhaust deflector. **1314765W** "Hawk" script.
.....\$85.00 ea.\$35.00 ea.

1314300W "Studebaker" script (2). **1314773W** "Golden" script.
.....\$40.00 ea.\$34.95 ea.

Total of all parts listed if purchased separately. ...\$1,274.85

801959 Total with 10% discount.....\$1,256.00 kit

1956 Golden Hawk (Gold Script/Dual Exhaust)

Includes all parts in basic kit plus:

AC-2754 Exhaust deflector. **1314773V** "Golden" script.
.....\$85.00 ea.\$34.95 ea.

1314300V Gold "Studebaker" script (2). **1314765V** "Hawk" script.
.....\$45.00 ea.\$40.00 ea.

Total of all parts listed if purchased separately\$1,509.70

Special Kit Price\$1,415.00

-10% quantity discount.. See page 6.....\$141.50

801960 Your Price.....\$1,273.50 kit

1957 Silver Hawk

Single Exhaust

AC-2704 Gas filler guard.
.....\$39.95 ea.

29-015 Valve stem caps.
.....\$5.95 set 4.

298301W Escutcheon, wiper pivot.
Chrome (2).\$18.00 ea.

524972X1 Oval bumper bolt with nut
and washer (8).\$6.95 set.

1314300W "Studebaker" script (2).
.....\$40.00 ea.

1314802 Stainless wiper arm.
.....\$25.00 ea.

1320695 Crest trunk emblem.
.....\$85.00 ea.

AC-2728 Outside mirrors (2).
.....\$105.00 ea.

287693W Chrome nut wiper pivot (2).
.....\$4.95 ea.

298316 Outside door handle
buttons (2).\$22.25 ea.

1312088W Headlight rims (2).
.....\$123.50 ea.

1314307 Crest grille emblem.
.....\$85.00 ea.

1314803 Stainless wiper arm.
.....\$25.00 ea.

1320940W "Silver" script.
.....\$40.00 ea.

AC-2840 Exhaust deflector.
.....\$119.95 ea.

298300 Leather gasket, wiper pivot (2).
.....\$3.50 ea.

298319 Outside door handle spring (2).
.....\$3.50 ea.

1312185W Hood ornament.
.....\$141.00 ea.

1314765W "Hawk" script.
.....\$35.00 ea.

1314810B Stainless wiper blades (2).
.....\$19.95 ea.

1541696 Round head bumper bolts (4).
.....\$2.50 ea.

Total of all parts listed if purchased separately.....\$1,436.70

Special Kit Price\$1,350.00

-10% quantity discount.. See page 6.....\$135.00

801961 Your Price.....\$1,215.00 kit

1957 Golden Hawk

AC-2704 Gas filler guard.\$39.95 ea.	AC-2728 Outside mirrors (2).\$105.00 ea.	AC-2840 Exhaust deflector.\$119.95 ea.
29-015 Valve stem caps.\$5.95 set 4.	287693W Chrome nut wiper pivot (2).\$4.95 ea.	298300 Leather gasket, wiper pivot (2).\$3.50 ea.
298301W Escutcheon, wiper pivot. Chrome (2).\$18.00 ea.	298316 Outside door handle buttons (2).\$22.25 ea.	298319 Outside door handle spring (2).\$3.50 ea.
524972X1 Oval bumper bolt with nut and washer (8).\$6.95 set.	800617W Fin louvers (10).\$190.00 set	1312088W Headlight rims (2).\$123.50 ea.
1314300V Gold "Studebaker" script (2).\$45.00 ea.	1314307 Crest grille emblem.\$85.00 ea.	1314765V "Hawk" script.\$40.00 ea.
1314802 Stainless wiper arm.\$25.00 ea.	1314773V "Golden" script.\$34.95 ea.	1314810B Stainless wiper blades (2).\$19.95 ea.
1314803 Stainless wiper arm.\$25.00 ea.	1320695 Crest trunk emblem.\$85.00 ea.	1320010V Hood "V" emblem.\$22.50 ea.
1320941V Gold bird emblem (2).\$22.00 ea.	1327014-5 Chrome roof Moulding.\$85.00 pr.	1541696 Round head bumper bolts (4).\$2.50 ea.
Total of all parts listed if purchased separately.....		\$1,706.60
Special Kit Price		\$1,600.00
-15% quantity discount.. See page 6.....		\$240.00
801962 Your Price		\$1,360.00 kit

1958 Silver Hawk

AC-2704 Gas filler guard.\$39.95 ea.	287693W Chrome nut wiper pivot (2).\$4.95 ea.	298319 Outside door handle spring (2).\$3.50 ea.
AC-2728 Outside mirrors (2).\$105.00 ea.	298300 Leather gasket, wiper pivot (2).\$3.50 ea.	524972X1 Oval bumper bolt with nut and washer (8).\$6.95 set.
AC-2840 Exhaust deflector.\$119.95 ea.	298301W Escutcheon, wiper pivot. Chrome (2).\$18.00 ea.	1312088W Headlight rims (2).\$123.50 ea.
29-015 Valve stem caps.\$5.95 set 4.	298316 Outside door handle buttons (2).22.25 ea.	1312185W Hood ornament.\$141.00 ea.
1314802 Stainless wiper arm.\$25.00 ea.	1314765W "Hawk" script.\$35.00 ea.	1314300W "Studebaker" script.\$40.00 ea.
1314803 Stainless wiper arm.\$25.00 ea.	1314810B Stainless wiper blades (2).\$19.95 ea.	1320695 Crest trunk emblem.\$85.00 ea.
1320940W "Silver" script.\$40.00 ea.	1320941V Gold bird emblem (3).\$22.00 ea.	1541696 Round head bumper bolts (4).\$2.50 ea.
Total of all parts listed if purchased separately.....		\$1,460.70
Special Kit Price		\$1,370.00
-10% quantity discount.. See page 6.....		\$137.00
801963 Your Price		\$1,233.00 kit

1958 Golden Hawk

AC-2704 Gas filler guard.\$39.95 ea.	AC-2840 Exhaust deflector (2).\$119.95 ea.	AC-2340 or AC-2728 Outside mirrors (2).\$105.00 ea.
29-015 Valve stem caps.\$5.95 set 4.	287693W Chrome nut wiper pivot (2).\$4.95 ea.	298300 Leather gasket, wiper pivot (2).\$3.50 ea.
298301W Escutcheon, wiper pivot. Chrome (2).\$18.00 ea.	298316 Outside door handle buttons (2).\$22.25 ea.	298319 Outside door handle spring (2).\$3.50 ea.
524972X1 Oval bumper bolt with nut and washer (8).\$6.95 set.	800617W Fin louvers (10).\$190.00 set.	1312088W Headlight rims (2).\$123.53 ea.
1314300V Gold "Studebaker" script (2).\$45.00 ea.	1314765V "Hawk" script.\$40.00 ea.	1314773V "Golden" script.\$34.95 ea.
1314802 Stainless wiper arm.\$25.00 ea.	1314810B Stainless wiper blades (2).\$19.95 ea.	1314803 Stainless wiper arm.\$25.00 ea.
1320010V Hood "V" emblem.\$22.50 ea.	1320695 Crest trunk emblem.\$85.00 ea.	1327014-5 Chrome roof Mouldings.\$85.00 pr.
1320941V Gold bird emblem (3).\$22.00 ea.	1541696 Round head bumper bolts (4).\$2.50 ea.	Total of all parts listed if purchased separately\$1,643.60
Special Kit Price		\$1,540.00
-15% quantity discount.. See page 6.....		\$231.00
801964 Your Price		\$1,309.00 kit.

1959 Silver Hawk

AC-2704 Gas filler guard.\$39.95 ea.	AC-2840 Exhaust deflector.\$119.95 ea.	AC-2918 Outside mirrors (2).\$105.00 ea.
AC-2840 Exhaust deflector.\$119.95 ea.	29-015 Valve stem caps.\$5.95 set 4.	287693W Chrome nut wiper pivot (2).\$4.95 ea.
298300 Leather gasket, wiper pivot (2).\$3.50 ea.	298301W Escutcheon, wiper pivot. Chrome (2).\$18.00 ea.	298316 Outside door handle buttons (2).\$22.25 ea.
298319 Outside door handle spring (2).\$3.50 ea.	524972X1 Oval bumper bolt with nut and washer (8).\$6.95 set.	1312088W Headlight rims (2).\$123.50 ea.
1312185W Hood ornament.\$141.00 ea.	1314300W "Studebaker" script (2).\$40.00 ea.	1541696 Round head bumper bolts (4).\$2.50 ea.
1314765W "Hawk" script (2).\$35.00 ea.	1314803 Stainless wiper arm.\$25.00 ea.	1314802 Stainless wiper arm.\$25.00 ea.
1314810B Stainless wiper blades (2).\$19.95 ea.	1320430X10 "Studebaker" trunk letters.\$108.00 set.	1320940W "Silver" script (2).\$40.00 ea.
1332218-9W Fin Moulding (2).\$75.00 set.	1332238 Fin emblem (2).\$35.00 ea.	1332243 Grille emblem. Also 1959 wagon tailgate emblem \$40.00 ea.
Total of all parts listed if purchased separately.....		\$1,667.70
Special Kit Price		\$1,565.00
-15% quantity discount.. See page 6.....		\$234.75
801965 Your Price		\$1,330.25 kit

**1960 Hawk
Single Exhaust**

AC-2704 Gas filler guard. \$39.95 ea.	AC-2840 Exhaust deflector. \$119.95 ea.	AC-2918 Outside mirrors (2). \$105.00 ea.
29-015 Valve stem caps. \$5.95 set 4.	287693W Chrome nut wiper pivot (2). \$4.95 ea.	298300 Leather gasket, wiper pivot (2). \$3.50 ea.
298301W Escutcheon, wiper pivot. Chrome (2). \$18.00 ea.	298316 Outside door handle buttons (2). \$22.25 ea.	298319 Outside door handle spring (2). \$3.50 ea.
524972X1 Oval bumper bolt with nut and washer (8). \$6.95 set.	1312088W Headlight rims (2). \$123.50 ea.	1312185W Hood ornament. \$141.00 ea.
1314300W "Studebaker" script (2). \$40.00 ea.	1314765W "Hawk" script (2). \$35.00 ea.	1314802 Stainless wiper arm. \$25.00 ea.
1314803 Stainless wiper arm. \$25.00 ea.	1320430X10 "Studebaker" trunk letters. \$108.00 set.	1332218-9W Fin Moulding (2). \$75.00 set.
1337188 Fin emblem (2). \$35.00 ea.	1541696 Round head bumper bolts (4). \$2.50 ea.	1337186 Grille emblem. \$35.00 ea.
1314810B Stainless wiper blades (2). \$19.95 ea.	Total of all parts listed if purchased separately..... \$1,627.70	
	Special Kit Price \$1,530.00	
	-15% quantity discount.. See page 6.....\$229.50	
801966 Your Price		\$1,300.50 kit

**1961 Hawk
Single Exhaust**

AC-2704 Gas filler guard. \$39.95 ea.	AC-2840 Exhaust deflector. \$119.95 ea.	29-015 Valve stem caps. \$5.95 set 4.
AC-2918 Outside mirrors (2). \$105.00 ea.	287693W Chrome nut wiper pivot (2). \$4.95 ea.	298300 Leather gasket, wiper pivot (2). \$3.50 ea.
298301W Escutcheon, wiper pivot. Chrome (2). \$18.00 ea.	524972X1 Oval bumper bolt with nut and washer (8). \$6.95 set.	1312088W Headlight rims (2). \$123.50 ea.
1312185W Hood ornament. \$141.00 ea.	1314300W "Studebaker" script (2). \$40.00 ea.	1314765W "Hawk" script (2). \$35.00 ea.
1314802 Stainless wiper arms. \$25.00 ea.	1320430X10 "Studebaker" trunk letters. \$108.00 set.	1314810B Stainless wiper blades (2). \$19.95 ea.
1314803 Stainless wiper arms. \$25.00 ea.	1332218-9W Fin Moulding (2). \$75.00 ea.	1337186 Grille emblem. \$40.00 ea.
1337188 Fin emblem (2). \$35.00 ea.	1360980 Outside door handles (2). \$65.00 ea.	1541696 Round head bumper bolts (4). \$2.50 ea.
Total of all parts listed if purchased separately..... \$1,706.200		
Special Kit Price \$1,600.00		
-15% quantity discount.. See page 6.....\$240.00		
801967 Your Price		\$1,360.00 kit.

1956 Hawk All Models (Basic Kit)

AC-2704 Gas filler guard.\$39.94 ea.	298316 Outside door handle buttons (2).\$22.25 ea.	1312439W Trunk emblem retainer.\$45.00 ea.
AC-2754 Exhaust deflector.\$85.00 ea.	298319 Outside door handle spring (2).\$3.50 ea.	1314307 Crest grille emblem.\$85.00 ea.
AC-2728 Outside mirrors (2).\$105.00 ea.	524972X1 Oval bumper bolt with nut and washer (8).\$6.95 set.	1314802 Stainless wiper arm.\$25.00 ea.
29-015 Valve stem caps.\$5.95 set 4.	800585 Plastic insert, trunk.\$55.00 ea.	1314803 Stainless wiper arm.\$25.00 ea.
287693W Chrome nut wiper pivot (2).\$4.95 ea.	1312088W Headlight rims (2).\$123.50 ea.	1314810B Stainless wiper blades (2).\$19.95 ea.
298300 Leather gasket, wiper pivot (2).\$3.50 ea.	1312185W Hood ornament.\$141.00 ea.	1541696 Round head bumper bolts (4).\$2.50 ea.
298301W Escutcheon, wiper pivot. Chrome (2).\$18.00 ea.	Total of all parts listed if purchased separately\$1,259.75 Special Kit Price\$1,180.00 -10% quantity discount.. See page 6.....\$118.00	
801923 Your Price\$1,062.00 kit		

SUPPLEMENTAL SMALL PARTS KITS

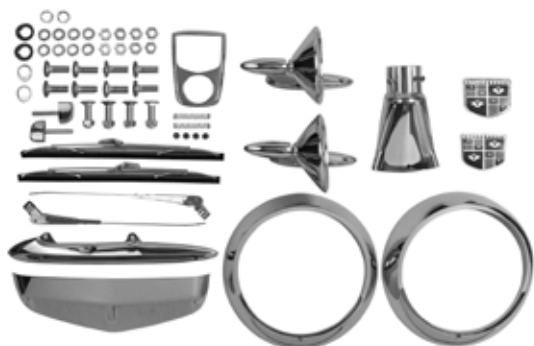

801923 depicted.

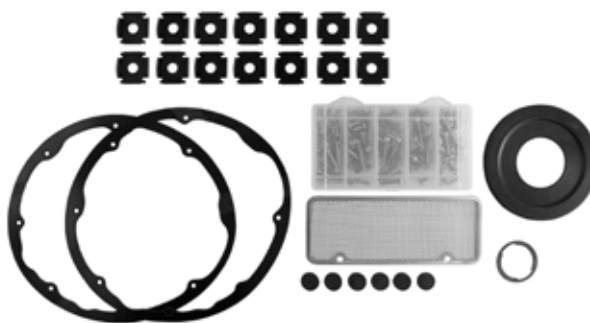

801985 depicted.

1953 Coupe & Hardtop

1048X4 Nail screws, cowl seal to body (2).\$1.50 ea.	295918 Seals, cowl Moulding studs (6).\$1.00 ea.	298340 Front fender to body seals (2).\$15.70 ea.
15-025A Screw kit, K-body hardtop. OR 15-025B Screw kit, C-body coupe.\$22.00 ea.	801614 Lens kit, includes parking tail light, license and related gaskets.\$185.00 ea.	303808 Clip, rear fender top Moulding (14).\$2.95 ea.
285968 Headlight gaskets, body to fender (2).\$6.00 ea.	286647 Grommet, gas tank filler neck.\$15.00 ea.	299850 Rear fender to body seals (2).\$7.00 ea.
297881 Gasket, trunk lock housing.\$2.00 ea.	285005P Screen, right front fender vent door outer.\$22.00 ea.	Total of all parts listed if purchased separately.\$365.10
801985 Kit price\$345.00 kit		

1954 Coupe & Hardtop

15-025A Screw kit, K-body hardtop. OR	801615 Lens kit. Includes parking lens, tail light lens, license lamp assembly and all related gaskets.
15-025B Screw kit, C-body coupe. \$22.00 ea. \$230.00 ea.
285005P Screen, right front fender vent door outer. \$22.00 ea.	285968 Headlight gaskets, body to fender (2). \$6.00 ea.
286647 Grommet, gas filler neck. \$15.00 ea.	297881 Gasket, trunk lock housing. \$2.00 ea.
298340 Front fender to body seals (2). \$15.70 ea.	299850 Rear fender to body seals (2). \$7.00 ea.
1048X4 Nail screws, cowl seal to body (2). \$1.50 ea.	295918 Seals, cowl Moulding studs (6). \$1.00 ea.
303808 Clip, rear fender top Moulding (14). \$2.95 ea.	Total of all parts listed if purchased separately. \$410.10
801986 Kit price \$385.00 kit.	

1955 Coupe & Hardtop

15-025A Screw kit, K-body hardtop. OR	1048X4 Nail screws, cowl seal to body (2). \$1.50 ea.
15-025B Screw kit, C-body coupe. \$22.00 ea.	
285005P Screen, right front fender vent door outer. \$22.00 ea.	285968 Headlight gaskets, body to fender (2). \$6.00 ea.
286647 Grommet, gas filler neck. \$15.00 ea.	297881 Gasket, trunk lock housing. \$2.00 ea.
298340 Front fender to body seals (2). \$15.70 ea.	299850 Rear fender to body seals (2). \$7.00 ea.
801616 Lens kit. Includes gaskets. \$162.00 ea.	Total of all parts listed if purchased separately. \$342.10
801987 Kit price \$320.00 kit	

1956 Golden Hawk

15-025A Screw kit, K-body hardtop. \$22.00 ea.	1048X4 Nail screws, cowl seal to body (2). \$1.50 ea.
1093X54 T-bolt, inner rear fin Moulding (24). \$1.50 ea.	285005P Screen, right front fender air vent door outer. \$22.00 ea.
285968 Headlight gaskets, body to fender (2). \$6.00 ea.	297881 Gasket, trunk lock housing. \$2.00 ea.
298340 Front fender to body seals (2). \$15.70 ea.	299850 Rear fender to body seals (2). \$7.00 ea.
801617 Lens kit (includes gaskets). \$160.00 ea.	Total of all parts listed if purchased separately. \$328.80
801988 Kit price \$310.00 kit	

1957-58 Silver Hawk

15-025B Screw kit, C-body coupe. \$22.00 ea.
1093X54 T-bolt, inner rear fin Moulding (24). \$1.50 ea.
285968 Headlight gaskets, body to fender (2). \$6.00 ea.
299850 Rear fender to body seals (2). \$7.00 ea.
1321155 Gasket, trunk lock housing. \$1.25 ea.
1048X4 Nail screws, cowl seal to body (2). \$1.50 ea.
285005P Screen, right front fender air vent door outer. \$22.00 ea.
298340 Front fender to body seals (2). \$15.70 ea.
801618 Lens kit. Includes gaskets. \$160.00 ea.
Total of all parts listed if purchased separately. \$301.05
801989 Kit price \$285.00 kit

1957-58 Golden Hawk

15-025A Screw kit, K-body hardtop. \$32.00 ea.
1093X54 T-bolt, inner rear fin Moulding (24). \$1.50 ea.
285968 Headlight gaskets, body to fender (2). \$6.00 ea.
298340 Front fender to body seals (2). \$15.70 ea.
801618 Lens kit. Includes gaskets. \$160.00 ea.
1337107X20 Clip kit, (20), wheel well opening Moulding. \$59.00 ea.
1048X4 Nail screws, cowl seal to body (2). \$1.50 ea.
285005P Screen, right front fender air vent door outer. \$22.00 ea.
295918 Seals, cowl Moulding studs (6). \$1.00 ea.
299850 Rear fender to body seals (2). \$7.00 ea.
1321155 Gasket, trunk lock housing. \$1.25 ea.
Total of all parts listed if purchased separately. \$453.05
801990 Kit price \$430.00 kit

1959-61 Hawk

15-025B Screw kit, C-body coupe. \$22.00 ea.	1048X4 Nail screws, cowl seal to body (2). \$1.50 ea.
1093X54 T-bolt, inner rear fin Moulding (30). \$1.25 ea.	285005P Screen, right front fender air vent door outer. \$22.00 ea.
285968 Headlight gaskets, body to fender (2). \$6.00 ea.	295918 Seals, cowl Moulding studs (6). \$1.00 ea.
298340 Front fender to body seals (2). \$12.00 ea.	299850 Rear fender to body seals (2). \$6.50 ea.
801619 Lens kit. Includes gaskets. \$220.00 kit.	1321155 Gasket, trunk lock housing. \$1.25 ea.
1337107X20 Clip kit (20), wheel well opening Moulding. ... \$119.00 ea.	Total of all parts listed if purchased separately. \$477.05
801991 Kit price \$450.00 kit	

1962 G.T. Hawk

15-025 Screw kit. \$28.00 ea.	295918 Seals, cowl Moulding studs (6). \$1.00 ea.
1048X4 Nail screws, cowl seal to body (2). \$1.50 ea.	298340 Front fender to body seals (2). \$12.00 ea.
3096X7 Gasket set (4-pieces). Tail light body to fender. \$8.00 set.	299850 Rear fender to body seals (2). \$6.50 ea.
285005P Screen, right front fender air vent door outer. \$22.00 ea.	801620 Lens kit. Includes gaskets. \$145.00 kit.
285968 Headlight gaskets, body to fender (2). \$6.00 ea.	1337107X20 Clip kit, (20), wheel well opening Moulding. ... \$59.00 ea.
1321155 Gasket, trunk lock housing. \$1.25 ea.	Total of all parts listed if purchased separately. \$416.05
801992 Kit price \$395.00 kit	

Early 1963 G.T. Hawk

15-025 Screw kit. \$28.00 ea.	298340 Front fender to body seals (2). \$12.00 ea.
1048X4 Nail screws, cowl seal to body (2). \$1.50 ea.	299850 Rear fender to body seals (2). \$6.50 ea.
3096X7 Gasket set (4-pieces). Taillight body to fender. ... \$8.00 ea.	801621 Lens kit (includes gaskets). \$175.00 kit.
285005P Screen, right front fender air vent door outer. \$22.00 ea.	1321155 Gasket, trunk lock housing. \$1.25 ea.
285968 Headlight gaskets, body to fender (2). \$6.00 ea.	1337107X20 Clip kit, (20), wheel well opening Moulding. ... \$59.00 ea.
295918 Seals, cowl Moulding studs (6). \$1.00 ea.	Total of all parts listed if purchased separately \$446.05
801993 Kit price \$420.00 kit	

Late 1963 G.T. Hawk

15-025 Screw kit. \$28.00 ea.
1048X4 Nail screws, cowl seal to body (2). \$1.50 ea.
3096X7 Gasket set (4-pieces). Taillight body to fender. \$8.00 ea.
285005P Screen, right front fender air vent door outer. \$22.00 ea.
285968 Headlight gaskets, body to fender (2). \$6.00 ea.
295918 Seals, cowl Moulding studs (4). \$1.00 ea.
298340 Front fender to body seals (2). \$12.00 ea.
299850 Rear fender to body seals (2). \$6.50 ea.
801622 Lens kit. Includes gaskets. \$190.00 kit.
1321155 Gasket, trunk lock housing. \$1.25 ea.
1337107X20 Clip kit (20), wheel well opening Mouldings. \$119.00 ea.
Total of all parts listed if purchased separately. \$461.05
801994 Kit price \$435.00 kit

1964 Hawk

Same as 1963 G.T. Hawk except
exchange 801622 for:

801623 Lens kit. Includes gaskets. \$190.00 kit.
3035X2 Side grille to body gasket. \$6.00 pr.
3305X3 Headlight rim to fender gasket (2). \$6.50 ea.
Total of all parts listed if purchased separately. \$480.05
801995 Kit price \$455.00 kit

**Don't see what
you need?
Please inquire
at
(317) 462-3124**

DOOR HINGES

- 297702** Right. Front upper. 1953-54 sedan and wagon. 1955's without curved windshield **\$40.00 ea.**
- 297703** Left. Front upper. 1953-54 sedan and wagon. 1955's without curved windshield **\$40.00 ea.**
- 298350** Right front lower. 1953-54 sedan and wagon, 1955 without wraparound windshield **\$42.00 ea.**
- 298351** Left front lower. 1953-54 sedan and wagon, 1955 without wraparound windshield **\$42.00 ea.**
- 298352** Right rear upper. 1953-62 car, all models **\$48.00 ea.**
- 298353** Left rear upper, 1953-62 car, all models **\$48.00 ea.**
- 298354** Right rear lower. 1953-62 car, all models **\$40.00 ea.**
- 298355** Left rear lower. 1953-62 car, all models **\$35.00 ea.**
- 303201** Left front upper. 1953-61 C&K bodies.... **\$135.00 ea.**
- 308168** Right front upper or lower. 1955 car, all with wrap-around windshield. All 1956-66 sedan, wagon, Lark 1960-64 T-Cab truck **\$55.00 ea.**
- 308169** Left front upper or lower. 1955, all with wrap-around windshield. All 1956-66 sedan, wagon, Lark. Truck; 1960-64 T-Cab **\$55.00 ea.**
- 652404** Right front upper. Truck: 1949-64 C-Cab **\$80.00 ea.**
- 652405** Left front upper. Truck: 1949-64 C-Cab **\$80.00 ea.**
- 1352300** Right rear lower, all 1963-66 car, all models **\$45.00 ea.**
- 1352301** Left rear lower. 1963-66 car, all models **\$45.00 ea.**
- 1353160** Right rear upper. 1963-66 car, all models **\$40.00 ea.**
- 1353161** Left rear upper. 1963-66 car, all models **\$40.00 ea.**

PRE-WAR EXTERIOR DOOR HANDLES

Call for availability and price.

ABOVE DOOR FLIPPERS

306000 Flipper actuator pad. 1953-58 hardtop. Includes Hawk. 1958 J-body hardtop **\$12.00 pr.**

801263 6 piece spring set for above door flippers on all 1953-58 K-body hardtop, Golden Hawk, Speedster, and Packard Hawk.. **\$30.00 ea.**

1327882-3 Right and left flipper assembly 1958 J-body hardtop **\$275.00 pr.**

DOOR LATCH SCREW

G157277 Door latch stainless steel retaining screw **50¢ ea.**



DOOR LATCHES

Note: On rebuilt exchanges, we must have your old latch first. Also, please remove remote opener link before sending in your old latch core. A **\$5.00** fee will be charged if we have to remove it.

- 265164** Right front. 1936-46 car, all models. Truck: 1941-48 M-Series. 1949-64 C-Cab. N.O.S. **\$150.00 ex.**
- 265165X** Left side (driver's door). C-Cab trucks 1957-64. Rebuilt exch. **\$150.00 ex.**
- 265166** Left rear. 1936-46 car, all models. N.O.S. **\$75.00 ea.**
- 265167** Left front. 1936-46 car, all models. Truck: 1941-48 M-Series. 1949-56 C-cab. Right rear, 1936-46 car, all models. N.O.S. **\$90.00 ea.**
- 284798** Right rear. 1947-50 car, all 4-door. N.O.S. **\$50.00 ea.**
- 284799** Left rear. 1947-50 car, all 4-door N.O.S. **\$65.00 ea.**
- 287186** Right front. 1947-48 car, all models. N.O.S. **\$95.00 ea.**
- 287187** Left front. 1947-48 car, all models. N.O.S. **\$80.00 ea.**
- 293830** Right rear. 1951 car, all 4-door. N.O.S. **\$50.00 ea.**
- 293831** Left rear. 1951 car, all 4-door. N.O.S. **\$68.25 ea.**
- 296794** Right front. 1949-52 car, all models. N.O.S. **\$70.00 ea.**
- 296795** Left front. 1949-52 car, all models. N.O.S. **\$85.00 ea.**
- 296796** Right rear door. 1952 car, all models. N.O.S. **\$60.00 ea.**
- 296797** Left rear door. 1952 car, all models. N.O.S. **\$59.00 ea.**
- 306280** Right front. 1953-55 sedan. N.O.S. **\$70.00 ea.**
- 306281** Left front. 1953-66 sedan, hardtop, convertible and station wagon. Rebuilt exchange. **\$155.00 ex.**
- 306282** Right rear. 1953-55 sedan. N.O.S. **\$50.00 ea.**

- 306283** Left rear. 1953-55 sedan. N.O.S. **\$50.00 ea.**
- 306332** Right. 1953-55 and 1958-64 C & K. N.O.S. **\$95.00 ea.**
- 306333** Left. 1953-55 and 1958-64 C & K. N.O.S. **\$95.00 ea.**
- 1312260** Right. 1956-57 Hawk. N.O.S. **\$80.00 ea.**
- 1312261** Left. 1956-57 Hawk. Rebuilt exchange. **\$155.00 ea.**
- 1312262** Right front. 1956-57 sedan. N.O.S. **\$80.00 ea.**
- 1312264** Right rear. 1956-57 sedan. N.O.S. **\$59.00 ea.**
- 1312265** Left rear. 1956-57 sedan. N.O.S. **\$59.00 ea.**
- 1323506** Right front. 1958-63 sedan includes Lark. Truck: 1960-64 Camp. Rebuilt exchange or use 306280. **\$155.00 ea.**
- 1323508** Right. 1958-63 Hawk. Rebuilt exchange or use 306332 **\$155.00 ea.**
- 1323509** Left. 1958-63 Hawk. Rebuilt exchange or use 306333. **\$155.00 ea.**
- 1323528** Right rear. 1958-63 sedan (includes Lark). N.O.S. **\$59.00 ea.**
- 1323529** Left rear. 1958-63 sedan includes Lark. N.O.S. **\$50.00 ea.**
- 1351774** Right. 1964 Hawk. Rebuilt exchange or use 306332. **\$155.00 ea.**
- 1351778** Right rear. 1964-66 Lark. N.O.S. **\$59.00 ea.**
- 1351779** Left rear. 1964-66 Lark. N.O.S. **\$59.00 ea.**

DOOR/BODY PLUG

G125619 Body plug, most models. Attaches to door post to cover fender bolts. 1.5 inch diameter. Nickle plated. **\$2.00 ea.**



EXTERIOR DOOR HANDLES & RELATED PARTS

286869 1947-52 car. Handle spring. Use to restore your old handle **\$4.50 ea.**

298316 Push button (chrome) door handle. 1953-66 all models **\$22.25 ea.**



298319 1953-66 spring for push button on door handles **\$3.50 ea.**

298974 1953-60 cars, all models. Truck: 1960. Used Chrome plated **\$75.00 ea.**



1360980 1961-66 car, all models. Truck: 1961-64 Champ (will also work on 1953-60 cars, all models) (NOS, may have slight shelf wear) **\$65.00 ea.**

1750235 Avanti outside door handle gasket, standard on later models, a good addition on earlier Avanti **\$4.00 ea.**



Note: Many other door handles in stock. Please inquire.

DOOR CHECK



- 297644** Rear door check, 1947-62 all models.....
.....\$20.00 ea.
- 1327195** Pin, 1947-66 all models\$2.50 ea.
- 297642** 53-64 C&K, 53-54 Sedan front, 55 Sedan w/straight windshield\$22.50 ea.
- 653096** 55 sedan w/curved windshield, 56-66 sedan front, 49-64 truck\$22.50 ea.

DOOR REMOTES



- 271322** Left front or right rear remote, 1939-46 Champion 2-door and 4-door except some late 1942 cars. Also use on 1941-48 M-Series truck.....\$32.00 ea.
- 271323** Right front or left rear remote, 1939-46 Champion 2-door and 4-door except some late 1942 cars. Also use on 1941-48 M-Series truck\$32.00 ea.
- 284686** Right front, 1947-48 Champion and Commander or right rear, 1947-52 Champion and Commander.\$30.00 ea.
- 284687** Left front. 1947-48 Champion and Commander or left rear, 1947-52 Champion and Commander.\$35.00 ea.
- 296728** Right or left front. 1949-52 Champion and Commander.\$39.00 ea.
- 297938** Right, 1953-55 all models\$27.50 ea.
- 297939** Left, 1953-55 all models\$27.50 ea.
- 652537** Right remote, 1949-64 C-cab truck.\$35.00 ea.
- 652538** Left remote, 1949-64 C-cab truck.....\$35.00 ea.
- 1314346** Right, 1956-66 all models\$27.50 ea.
- 1314347X1** Spring, left side, 1956-66 all models.\$27.50 ea.
- 1351350** Right, rear door locking control. 1963-66 4-door station wagon.\$19.00 ea.
- 1351351** Left, rear door locking control. 1963-66 4-door station wagon.\$19.00 ea.

DOOR HINGE PARTS

- 2046X7** Door hinge screw for most years and model car. Includes washer. 1/4 inch\$1.80 ea.
- 1350427** Avanti hinge spring\$5.00 ea. 
- 1350430** Avanti hinge bushing (brass) need 8 per car.\$4.00 ea. 
- 1352309** Rear hinge spring, 1963-66 4-door\$4.75 ea.

DOOR HINGE PINS



- 271149** 1939-46 Champion 4-door front upper; 4-door, rear upper and lower, 2-door upper. 1940-42 Commander and President 4-door rear door upper and lower, 2-door, upper. 1941-48 M-Series truck; upper. 1947-52 4-door front lower; rear upper and lower, 2-door lower. 1953-54 sedan and 1955 sedan without wrap-around windshield 4-door front lower; rear door upper and lower. Late 1955-62 4-door, rear upper and lower. 1953-64 C & K, includes Hawk, lower.....\$12.00 ea.



- 284506** 1947-52 4-door front upper; 2-door upper. 1953-54 and 1955 4-door sedan without wrap-around windshield front upper. 1955 4-door with wrap-around windshield and 1956-66 2-door and 4-door front lower. 1953-58 2-door sedan upper and lower. 1953-64 C & K (includes Hawk) upper. 1959-66 Lark 2-door and 4-door front upper and lower.\$12.00 ea.

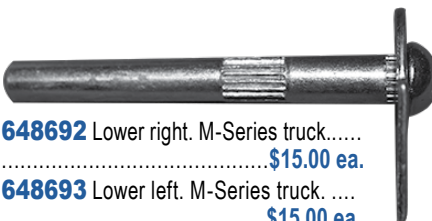

- 648692** Lower right. M-Series truck.....\$15.00 ea.
- 648693** Lower left. M-Series truck.\$15.00 ea.



- 652522** Truck: 1949-64 C-cab. Takes 4\$10.00 ea.

CHILD SAFETY LOCK SET

Note: Prevents door from opening from inside.

- 1350423** Avanti hinge pin.\$9.25 ea.



- AC-1822** For 2 rear doors on 1947-52. NOS.....\$24.00 ea.
- AC-2426** For 2 rear doors on 1953-55. NOS\$34.00 ea.
- AC-3456** For 2 rear door on 1963-66. NOS.....\$15.50 ea.
- SP-50079** For 2 rear doors on 1956-62 4-door car. NOS\$12.50 ea.

DOOR STRIKER PLATE PARTS

- 284212** Striker retainer plate. 1936-55 all models. Truck: 1941-48 M-Series. 1949-64 C-cab.....\$14.50 ea.

- 266180** Striker plate shim 1/16 inch thick. For 306240 or 306241 striker plates\$3.50 ea.

- 306240** Right. 1936-55 car, all models. Truck: 1941-48 M-Series. 1949-64 C-cab.....\$45.00 ea.



- 306241** Left. 1936-55 car, all models. Truck: 1941-48 M-Series. 1949-64 C-cab.\$45.00 ea.

- 1314902** Right. 1956-66 car, all models. Truck: 1960-64 Champ.....\$45.00 ea.



- 1314903** Left. 1956-66 car, all models. Truck: 1960-64 Champ.....\$45.00 ea.

- 1322514** Striker retainer plate. 1958-66 all models except Avanti.\$12.50 ea.

- 1322516** Spacer door striker 5/16 inch. 1958-66 all models except Avanti.....\$3.00 ea.



- G156112** Screw 7/8 inch. 1936-55 car, all models. 1956-66 car, all models. Takes 2 per door. Truck: 1941-48 M-Series. 1949-64 C-cab 1960-64 Champ. Cars take 2 per door, Trucks take 4 per door50¢ ea.

- G156145** Screw, 1 1/2 inch. 1956-66 car, all models. Truck: 1960-64 Champ. Takes 1 per door35¢ ea.

DOOR LOCK RETAINER CLIPS

- 271237** Door lock retainer clips. 1939-62 with Yale locks\$3.00 ea.



- 271441** Door lock retainer clips. 1939-62 cars. 1941-48 M-Series & 1949-54 Trucks all with Hurd locks. 1963-66 All except Avanti.....\$3.00 ea.

LOCKS

Ignition & Door Locks Matched Sets



Ignition lock, 2 outside door locks and 4 keys. All locks are keyed the same.

1558200 1963-66 Lark..... **\$149.95 set**

1558202 1963-64 Hawk..... **\$149.95 set**

Ignition lock, 1 outside door locks and 2 keys. All locks are keyed the same.

DOOR LOCKS

Note: (Includes keys and 1 lock unless otherwise stated.)

Post-war Early Style (1947-62)

287499 1947-48 car all models. Hurd..... **\$80.00 ea.**

287499X (2) Matched sets for 1947-48 car all models. Hurd..... **\$145.00/set of 2**

289336 (2) 1949-52 Champion. Yale..... **\$80.00 ea.**

289337 (2) 1949-52 Commander & Land Cruiser. Hurd..... **\$80.00 ea.**

299845 1953-61 sedan & wagon, 1959-61 Lark. 1960-61 truck (T-Cab)..... **\$80.00 ea.**

299845X (2) Matched sets for 1953-61 sedan & wagon, 1959-61 Lark. 1960-61 truck (T-Cab)..... **\$145.00/set of 2**

308790 1955 President long wheel base 4-door sedan. Yale..... **\$80.00 ea.**

308791 1955 President long wheel base 4-door sedan. Hurd..... **\$80.00 ea.**

653745 Truck: 1955-62 C-Cab Truck & will fit 1949-54..... **\$85.00 ea.**

653745X (2) Matched sets for Truck: 1955-62 C-Cab Truck & will fit 1949-54..... **\$145.00 set of 2**

1323042 1957 Packard..... **\$80.00 ea.**

1343377 1962 Lark. Truck: 1962 truck (T-Cab)..... **\$80.00 ea.**

Postal Zip Van

1657107 Lock cylinder, less keys for rear roll-up door on all 8E Zip Van Postal Delivery vehicles..... **\$15.00 ea.**

1657110 Lock cylinder, use keys for sliding door on all 8E Zip Van Postal Delivery vehicles..... **\$15.00 ea.**

DOOR LOCK SEALS

1321155 Seal, door lock. 1947-66 car, all models except 1958 Packard Hawk..... **\$1.25 ea.**



IGNITION & DOOR KEYS

525810 1947-59 models with Yale lock. Same key should operate both ignition & doors..... **\$8.00 pr.**



525931 1947-60 models with Hurd lock. Same key should operate both ignition & doors..... **\$8.00 pr.**

Note: This key is easily identified because the shaft is quite short.

1555550 1960-63 all models including Avanti. Same key should operate both ignition & doors..... **\$8.00 pr.**



1561741 1964-66 all models & 1964-70 Avanti. Same key should operate both ignition and doors..... **\$8.00 pr.**

801542 Deluxe ignition & door key blank for all models 1947-63 with Yale locks. Beautiful gold finish with crest logo..... **\$7.95 ea.**



801543 Deluxe ignition & door key blank for all models 1947-60 with Hurd locks. Hurd keys have a very small shaft. Beautiful gold finish with crest logo..... **\$7.95 ea.**



1963-66 STYLE DOOR LOCKS & DOOR LOCK SETS

Note: Type without external Key-Slot cover.

Note: *Will also fit 1953-62 sedans, station wagon, Lark, & 1960-61 truck.

Note: **Will also fit 1953-62 C & K Bodies (Hardtops, Hawks, Coupes).

1352164 1963-66 4-dr Lark. Truck: 1963-64 truck..... **\$80.00 ea.**

***1352164X2** (2) matched locks for 1963 4-door Lark. Truck: 1963-64 truck..... **\$135.00 pr.**

***1352169** 1963-66 2-door Lark.. **\$80.00 ea.**

***1352169X2** (2) Matched set for 1963-66 2-door Lark..... **\$135.00 ea.**

1963-64 C-CAB TRUCKS

****1352168** 1963-64 Hawk..... **\$80.00 ea.**

****1352168X2** (2) Matching sets for 1963-64 Hawk..... **\$149.95 pr.**

1656312 8E C-cab trucks..... **\$80.00 ea.**

TRUNK LOCK HOUSINGS (HOUSING ONLY)

307590 1953-55 all..... **\$96.00 ea.**



1312352 1956 Hawk.... **\$105.00 ea.**

1312357 1956 sedan..... **\$96.00 pr.**

1321150 1957-58 all and 1957-64 Hawk..... **\$45.00 ea.**

1331670 1959-60 Lark..... **\$35.00 ea.**

1338256 1961 Lark..... **\$40.00 ea.**



1343046 1962-63 Lark..... **\$45.00 ea.**

TRUNK LOCK HOUSINGS

Note: 1358549 and 1362038 are interchangeable.

Note: With cylinders and key.

1358549 1964-early 66 car except station wagon. Takes 2 groove keys..... **\$70.00 ea.**

1362038 Late 1966 car. Takes 3-groove keys..... **\$70.00 ea.**

TRUNK LOCK CYLINDERS WITH KEYS (DOES NOT INCLUDE HOUSING)

265595 1936-42 car and 1946-50 car with Yale equipment..... **\$30.00 ea.**

293608 1951-63 car all models & 1964 Hawk. Yale. Includes 2 keys..... **\$50.00 ea.**

287039 1947-50 car with Hurd equipment... **\$18.50 ea.**

TRUNK LOCK SEALS

297881 Seal. 1953-56 car, all models and 1958 Packard Hawk... **\$2.00 ea.**



1321155 Seal. 1957-66 car, all models! except 58 Packard Hawk..... **\$1.25 ea.**

TRUNK LOCK RETAINER CLIPS

- 297880** Trunk. 1953-56 all models, and 1958 Packard Hawk..... **\$3.00 ea.**
- 1332039** Trunk. 1957-63 all models **\$3.00 ea.**

TRUNK LOCK TO LATCH "LINK"



- 1321156** 1957-64 Hawk..... **\$4.75 ea.**

TRUNK KEYS

Note: These keys can also be used for glove boxes.

- 290635** 1947-55 with Yale lock.. **\$8.00 pr.**



- 1343378** 1960-63 all models including Avanti..... **\$8.00 pr.**

- 1360849** 1964-66 all models including Avanti. **\$8.00 pr.**



TRUNK LOCK ASSEMBLY

- 293076** 1951-52 Champion and Commander..... **\$65.00 ea.**
- 307630** 1953-55 car **\$70.00 ea.**
- 1314494** 1959-61 Lark **\$50.00 ea.**
- 1314495** 1957-58 all models except Packard Hawk. 1959-64 Hawk. **\$70.00 ea.**



TRUNK HINGE SPRING



- Note: "*" Means springs are included.*
- 298989** Hinge spring, 1953-55 sedan **\$18.00 ea.**
- 311401** Hinge spring, 1953-64 C & K includes Hawk (Takes 4) **\$12.00 ea.**
- 1312118P** 1956-59 sedan and Lark. Takes 2 **\$18.00 ea.**
- 1350800** Avanti trunk lid springs, 1963-85 Takes 4 **\$6.50 ea.**

STATION WAGON TAILGATE LOCK CYLINDERS (WITH KEYS)



- 293608** 1954-61 except 1954 Commander (Yale) (Includes 2 keys)..... **\$50.00 ea.**
- 1353600** 1963 with manual windup rear window. Cylinder & keys **\$40.00 ea.**
- 1353601** 1963 with electric windup rear window. Cylinder & keys **\$40.00 ea.**
- 1353823** Tailgate & glove box lock kit. 1963 with manual rear window..... **\$50.00 ea.**
- 1353824** Tailgate & glove box lock kit. 1963 with electric rear window..... **\$50.00 ea.**
- 1360577** Tailgate & glove box lock kit. 1964-66 with manual rear window **\$50.00 ea.**
- 1360578** Tailgate & glove box lock kit. 1964-66 with electric rear window..... **\$50.00 ea.**
- 1360837** 1964-66 with manual rear window. **\$45.00 ea.**
- 1360838** 1964-66 with electric rear window **\$40.00 ea.**

TRUNK HANDLES & RELEASE LEVERS

- 284977W** Chrome handle, part with lock cylinder hole, not complete assembly. 1947-49 Champion with Yale lock..... **\$40.00 ea.**
- 287038W** Chrome handle, part with lock cylinder hole, not complete assembly. 1947 Champion & 1947-49 Commander with Hurd .. **\$48.00 ea.**
- 289872W** Chrome handle, part with lock cylinder hole, not complete assembly. 1950 Champion with Yale lock..... **\$40.00 ea.**
- 289873W** Chrome handle. 1950 Commander with Hurd lock **\$40.00 ea.**
- 293065P** Release lever. 1951 Champion & Commander..... **\$24.00 ea.**
- 296457** Release lever. 1952 Champion and Commander..... **\$24.00 ea.**

- 1351170** Avanti trunk release handle.... **\$22.50 ea.**



TRUNK HINGES

- *274292** 1941-46 all car models **\$150.00 pr.**
- *298976** Right. 1953-55 sedan..... **\$55.00 ea.**
- *298977** Left. 1953-55 sedan **\$55.00 ea.**
- *1316122** Right. 1956-58 sedan and J-Body hardtop. **\$51.50 ea.**
- *1316123** Left. 1956-58 sedan and J-Body hardtop **\$51.50 ea.**
- *1331636** Right. 1959 Lark **\$50.00 ea.**
- *1331637** Left. 1959 Lark **\$50.00 ea.**
- *1336880** Right. 1960 Lark **\$50.00 ea.**
- *1336881** Left. 1960 Lark **\$50.00 ea.**
- *1338426** Right. 1961 Lark **\$50.00 ea.**
- *1338427** Left. 1961 Lark **\$50.00 ea.**
- *1342484** Right. 1962-63 Lark **\$50.00 ea.**
- *1342485** Left. 1962-63 Lark **\$50.00 ea.**
- *1360890** Right. 1964-66 Lark..... **\$50.00 ea.**
- *1360891** Left. 1964-66 Lark **\$50.00 ea.**



Is time running out on your Renovation?

Give us a call!

TRUNK HANDLE SEALS



- 287019** 1947-49 Champion and Commander **\$10.00 ea.**
- 289827** 1950 Champion & Commander..... **\$10.00 ea.**
- 293392** 1951 Champion & Commander. **\$10.00 ea.**

TRUNK LID STRIKERS

- 1356975** 1964-66 Lark **\$9.50 ea.**



TRUNK RELEASE CABLE

- 1351014** All Avanti with internal manual release cable. Does not include handle..... **\$95.00 ea.**

1954-59 STATION WAGON TAILGATE PARTS

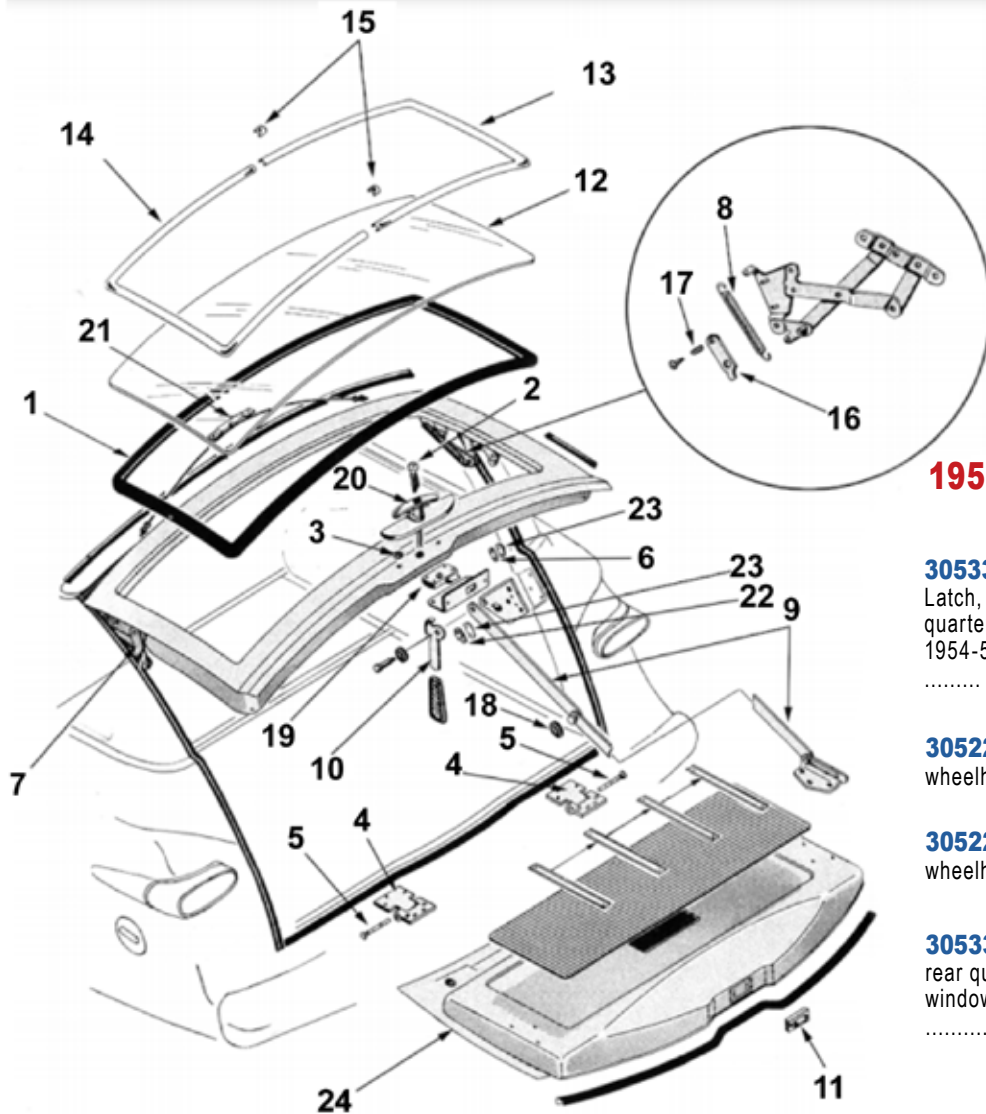

- | | |
|--|---|
| 1.) 2009X1 Rear glass seal. 1954-59.....
.....\$130.00 ea. | 10.) 305188 Right handle. 1954-59 (Includes
grip).....\$15.00 ea. |
| 2.) 293608 Lock & key. 1954-59\$50.00 ea. | 10.) 305189 Left handle. 1954-59.....
.....\$15.00 ea. |
| 3.) 295918 Seal, outer lock release handle
1954-59.....\$1.00 ea. | 11.) 305206 Striker, on lower tailgate. 1954-59..
.....\$10.00 ea. |
| 4.) 305100 Hinge. 1954-59.....\$45.00 ea. | 12.) 305218 NOS. Rear glass. 1954-59.....
.....\$225.00 ea. |
| 5.) 305101 Hinge pin. 1954-59.....\$7.25 ea. | 13.) 305350 Moulding, right window reveal
1954-59.....\$35.00 ea. |
| 6.) 305139 Rubber bumper tailgate side. 1954-
55.....\$4.25 ea. | 14.) 305351 Moulding, left window reveal 1954-
59.....\$35.00 ea. |
| 6.) 1314620 Rubber bumper tailgate side.
1956-59.....\$4.50 ea. | 15.) 305358 Clip, window reveal Moulding
1954-59.....\$4.50 ea. |
| 7.) 305162 Hinge, right upper tailgate. 1954-59.
.....\$48.50 ea. | 16.) 305406 Locking arm, upper hinge 1954-59
.....\$4.50 ea. |
| 7.) 305163 Hinge, left upper tailgate. 1954-59...
.....\$48.50 ea. | 17.) 305409 Spring, arm tension. 1954-59.....
.....\$2.50 ea. |
| 8.) 305173 Spring, upper hinge.....\$8.50 ea. | 18.) 305411 Anti-rattle grommet. 1954-59.....
.....\$2.50 ea. |
| 9.) 305176 Right lower tailgate support. 1954-
59.....\$51.50 ea. | 19.) 305453 Latch, upper to lower tailgate 1954-
59.....\$36.00 ea. |
| 9.) 305177 Left lower tailgate support. 1954-59
.....\$51.50 ea. | |

- | |
|---|
| 20.) 305662 Upper tailgate release
handle 1954-59.....\$51.50 ea. |
| 21.) 305842 Stabilizer, upper tailgate.
1954-59.....\$36.00 ea. |
| 22.) 1314620 Rubber bumper, lower
side 1959.....\$4.50 ea. |
| 23.) 1314621 Shim. 1959.....
.....\$1.00 ea. |

1954-59 STATION WAGON RELATED PARTS

- 305330**
Latch, rear
quarter window.
1954-59.....
.....\$22.25 ea.



- 305220** Retainer, right rear seat back to
wheelhouse panel. 1954-59.....\$15.00 ea.

- 305221** Retainer, left rear seat back to
wheelhouse panel. 1954-59.....\$18.00 ea.

- 305335** Handle,
rear quarter
window. 1954-59
.....\$18.00 ea.



STATION WAGON TAILGATE PARTS, 1960-62 LARK

- | |
|---|
| 1.) 305100 Hinge, lower tailgate. 1960-62.....
.....\$45.00 ea. |
| 2.) 305101 Hinge pin, lower tailgate. 1960-62...
.....\$7.25 ea. |
| 3.) 305411 Anti-rattle grommet, lower support
arm. 1960-62.....\$2.50 ea. |
| 4.) 1314620 Rubber bumper, tailgate side pillar.
1960-62.....\$4.50 ea. |
| 5.) 1334473 Lower tailgate skid strip. 1960.....
.....\$12.00 ea. |
| 5.) 1338724 Lower tailgate skid strip. 1961-62..
.....\$12.00 ea. |
| 6.) 1336170 Right lower tailgate support. 1960.
.....\$35.00 ea. |

STATION WAGON TAILGATE PARTS, 1960-62 LARK

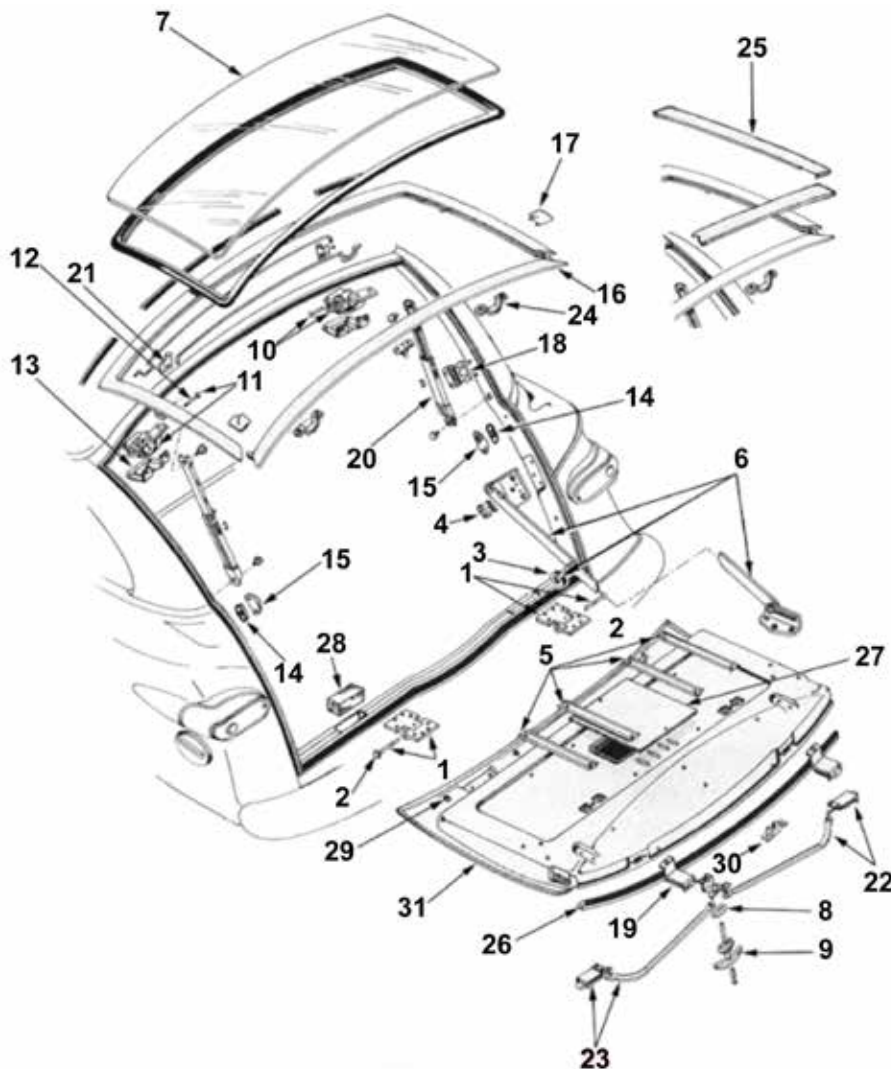

- 6.) **1336171** Left lower tailgate support. 1960-62.....**\$35.00 ea.**
- 6.) **1338370** Right lower tailgate support. 1961-62.....**\$35.00 ea.**
- 6.) **1338371** Left lower tailgate support. 1961-62.....**\$35.00 ea.**
- 7.) **1336177** Glass, upper tailgate (tinted). 1960-61.....**\$245.00 ea.**
- 7.) **1343227** Glass, upper tailgate (tinted). 1962.....**\$245.00 ea.**
- 8.) **1336245** Gasket, lower release handle. 1960-62.....**\$2.00 ea.**
- 9.) **1336248** Chrome handle, lower tailgate release. 1960-62.....**\$45.00 ea.**

- 10.) **1336390** Hinge, right upper tailgate. 1960-62.....**\$45.00 ea.**
- 11.) **1336391** Hinge, left upper tailgate. 1960-62.....**\$45.00 ea.**
- 12.) **1336396** Hinge pin. 1960-62.....**\$6.00 ea.**
- 13.) **1336399P** Left hinge cover. 1960-62.....**\$10.50 ea.**
- 14.) **1336422** Shim, pillar striker, 1/16 inch. 1960-62.....**\$2.50 ea.**
- 15.) **1336437** Tailgate striker on pillar. 1960-62.....**\$10.25 ea.**
- 16.) **1336606P** Frame, lower tailgate. 1960.....**\$90.00 ea.**

- 17.) **1336610P** Cover, lower frame joint (painted). 1960-62.....**\$10.00 ea.**
- 18.) **1336669** Shim for side bumper. 1960-62.....**\$1.00 ea.**
- 19.) **1336686** Latch, lower to upper tailgate. 1960-62.....**\$18.00 ea.**
- 20.) **1336800** Support, right upper tailgate 1960-62.....**\$38.50 ea.**
- 21.) **1336983** Bracket, anchors left torsion bar. 1960-62.....**\$5.00 ea.**
- 22.) **1337172** Right latch & link, tailgate to pillar. 1960-62.....**\$30.00 ea.**
- 23.) **1337173** Left latch & link, tailgate to pillar. 1960-62.....**\$30.00 ea.**
- 24.) **1337319** Tailgate striker, on upper tailgate 1960-62.....**\$12.00 ea.**
- 25.) **1337340** Right side cover tailgate frame. 1960-62.....**\$18.00 ea.**
- 26.) **1337350** Weatherstrip, lower to upper tailgate. 1960-62.....**\$30.00 ea.**
- 27.) **1338708P** Cover, tailgate opening. 1961-62.....**\$10.00 ea.**
- 28.) **1338965** Seal, hinge pocket. 1961-62.....**\$2.50 ea.**
- 29.) **1339790X1** Rubber bumper, tailgate to spare wheel. 1962.....**\$2.50 ea.**
- 1340086** Retainer, right rear seat back to wheelhouse panel. 1960-62.....**\$15.00 ea.**
- 1340087** Retainer, left rear seat back to wheelhouse panel. 1960-62.....**\$15.00 ea.**
- 30.) **1343170** Dovetail, lower tailgate. 1962.....**\$31.00 ea.**
- 30.) **1357726** Lower tailgate assembly. 1961-62.....**\$350.00 ea.**
- 1336807** Screw, upper tailgate. 1960-62 station wagon. Takes 4.....**\$5.50 ea.**
- 1336668** Rubber bumper, lower tailgate side, 1960-62.....**\$7.25 ea.**

Note: # Symbol indicates limited availability on a NOS piece.) Denotes parts book illustration number.

STATION WAGON TAILGATE PARTS, 1963-66 LARK

- 2.) **289864** Rubber bumper, tailgate support arm. 1963-66 **\$3.00 ea.**
- 3.) **1336422** Shim, pillar striker, 1/16". 1963-66. **\$2.50 ea.**
- 4.) **1351263** Motor, tailgate window lift. 1963-66..... **\$295.00 ea.**
- 5.) **1352229** Latch, tailgate to pillar. 1963-66... .. **\$22.50 ea.**
- 6.) **1352460** Switch, tailgate window up/down (on dash) 1963-66..... **\$51.50 ea.**
- 6.) **1360535** "Up-down" escutcheon, electric rear window on dash. 1964-66..... **\$5.00 ea.**
- 7.) **1352546** Bracket, torsion rod anchor. 1963-66..... **\$10.00 ea.**
- 8.) **1352831** Bracket, torsion rod. 1963-66 **\$10.00 ea.**
- 9.) **1353291** Lower tailgate support. 1963-66 .. **\$15.50 ea.**
- 9.) **1352528** Bolt, support to tailgate. 1963-66. **\$3.50 ea.**
- 9.) **1352529** Bolt, support pillar. 1963-66..... **\$3.50 ea.**
- 10.) **1353346** Tailgate glass & frame, clear. 1963-66 with sliding roof..... **\$375.00 ea.**
- 10.) **1353347** Tailgate glass & frame, tinted. 1963-66 with sliding roof..... **\$395.00 ea.**
- 10.) **1355408** Tailgate glass, clear. 1963-66 without sliding roof **\$235.00 ea.**
- 10.) **1355409** Tailgate glass, tinted. 1963-66 with sliding roof **\$245.00 ea.**
- 11.) **1353353** Frame only, upper & sides, tailgate glass. 1963-66..... **\$95.00 ea.**
- 16.) **1353700** Chrome control & handle assembly. 1963-66 wagon with manual lift **\$95.00 ea.**
- 16.) **1353900** Chrome control & handle assembly. 1963-66 station wagon with electrically operated rear glass **\$95.00 ea.**
- 17.) **1353706** Adapter, tailgate window regulator control. 1963-66 wagon with manual lift **\$22.00 ea.**
- 18.) **1353740** Retainer, tailgate pawl spring. 1963-66 wagon with manual lift **\$3.00 ea.**
- 19.) **1353747** Gasket, control & handle assembly to tailgate. 1963-66..... **\$4.00 ea.**
- 20.) **1353823** Lock kit, tailgate and glove box. 1963 wagon with manual lift..... **\$50.00 ea.**
- 20.) **1360577** Lock kit, tailgate & glove box. 1964-66 wagon with manual lift ... **\$50.00 ea.**

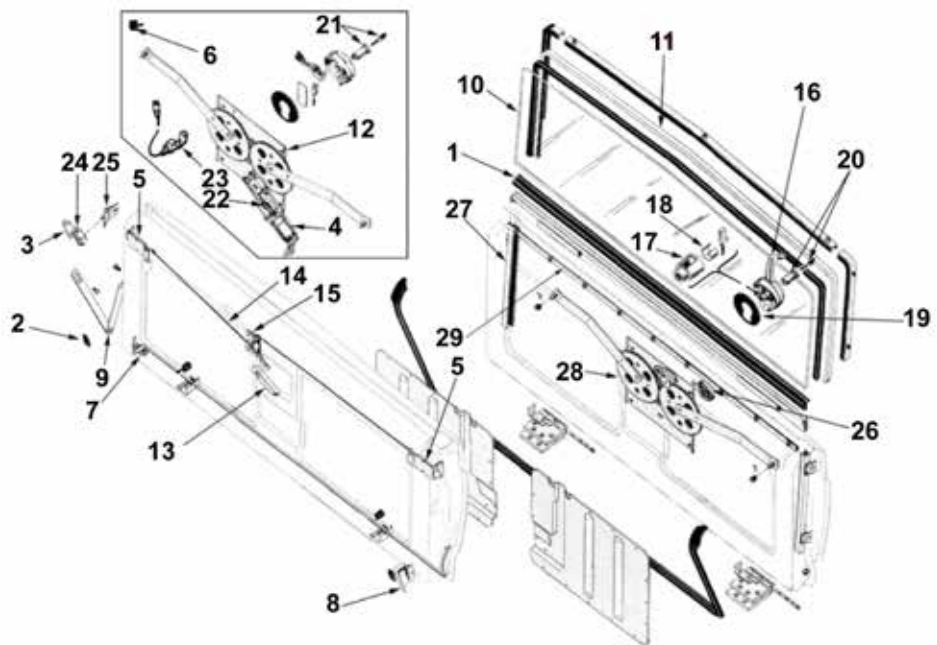

- 20.) **1353600** Tailgate lock, only. 1963 wagon with manual lift **\$40.00 ea.**
- 21.) **1353601** Tailgate lock, only. 1963 wagon with electric lift **\$40.00 ea.**
- 22.) **1353927** Rear window drive assembly. 1963-66 wagon with electric lift ... **\$85.00 ea.**
- 23.) **1355072** Switch, window lift regulator safety. 1963-66 **\$45.00 ea.**
- 24.) **1355100** Keeper. Right dovetail, on pillar. 1963-66 **\$22.50 ea.**
- 24.) **1355101** Keeper. Left dovetail on pillar. 1963-66 **\$22.50 ea.**
- 25.) **1355106** Right dovetail on tailgate. 1963-66..... **\$26.50 ea.**
- 25.) **1355107** Left dovetail on tailgate. 1963-66 **\$26.50 ea.**
- 26.) **1355288** Spring, tailgate window regulator balance. 1963-66..... **\$15.00 ea.**
- 27.) **1355403** Lower glass run, in tailgate. 1963-66 wagon without sliding roof **\$31.25 ea.**
- 12.) **1353450** Tailgate window regulator. 1963-66 with electric lift. **\$195.00 ea.**
- 13.) **1353546W** Chrome handle, interior lock release. 1963-66..... **\$16.00 ea.**
- 14.) **1353558** Link, right lock to handle. 1963-66 **\$18.00 ea.**
- 15.) **1353564** Lever & bracket, interior lock release. 1963-66 **\$41.50 ea.**
- 21.) **1353824** Lock kit, tailgate & glove box. 1963 wagon with electric lift **\$50.00 ea.**
- 21.) **1360578** Lock kit, tailgate & glove box. 1964-66 wagon with electric lift ... **\$50.00 ea.**
- 21.) **1360838** Tailgate lock, only. 1964-66 wagon with electric lift **\$40.00 ea.**
- 27.) **1353806** Lower glass run, in tailgate. Minus mounting bracket. 1963-66 wagon with sliding roof..... **\$32.50 ea.**
- 28.) **1358585** Tailgate window regulator. 1963-66 wagon with manual lift..... **\$195.00 ea.**
- 29.) **1352258** Weather seal, inner window opening. Includes clips. 1963-66 .. **\$32.50 ea.**

STATION WAGON RELATED PARTS, 1963-66 LARK



1355244 Latch, sliding roof top. 1963-66 **\$22.25 ea.**

1355518 Retainer, right rear seat back to wheelhouse panel. 1963-66 **\$22.50 ea.**

1355519 Retainer, left rear seat back to wheelhouse panel. 1963-66 **\$22.50 ea.**

1358030 Catch, sliding roof. 1963-66 **\$25.00 ea.**



Don't see what you need?
Please inquire at
(317) 462-3124

Note:

Symbol indicates limited availability on a new stocked piece.

() Denotes parts book illustration number.

RADIATOR AIR DEFLECTORS THAT FIT UP UNDER (0502-84)

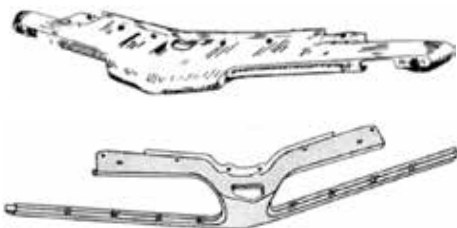

#288766 1947-48 Champion. (0502-25) Fits under deflector 284344.....\$90.00 ea.

#297820 1953 All except C & K. (0502-23) Fits under deflector 297776.....\$70.00 ea.

#306517 1954 All except C & K (0502-23) Fits under deflector 297776.....\$70.00 ea.

FRONT NOSE PANELS



#289546 1950 Commander.....\$125.00 ea.

#293230 1951-Cars, all.....\$250.00 ea.

1338128 1961 Lark with dual headlights.....\$225.00 ea.

1339213 1961 Lark with single headlights.....\$175.00 ea.

1342512 1962-63 Lark.....\$250.00 ea.

1362209 Grille Panel. 1966 all models.....\$110.00 ea.

FRONT FENDERS

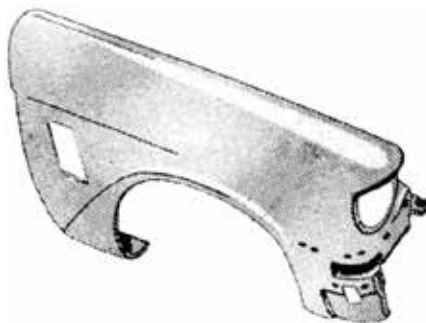

#275965 Left. 1941 Champion.....\$600.00 ea.

#275966 Right. 1941 Commander..\$700.00 ea.

#275967 Left. 1941 Commander....\$700.00 ea.

#282618 Right. 1942 Commander..\$600.00 ea.

#282619 Left. 1942 Commander....\$600.00 ea.

#285621 Left. 1947-49 Champion..\$700.00 ea.

#286181 Left. 1952 Car.....\$650.00 ea.

#289830 Right. 1950 Commander..\$700.00 ea.

#297284 Right. 1955 sedan & station wagon without wraparound windshield.....\$600.00 ea.

308156 Right, includes apron. 1955 sedan & station wagon without wraparound windshield.....\$700.00 ea.

#308613 Left, includes apron. 1955 sedan & station wagon with wraparound windshield.....\$600.00 ea.

#1312156 Right. 1956 sedan & station wagon.....\$650.00 ea.

#1312157 Left. 1956 sedan & station wagon.....\$650.00 ea.

#1320499 Left front less apron. 1957 sedan & station wagon.....\$650.00 ea.

#1323200 Right. 1957 Packard.....\$800.00 ea.

#1323201 Left. 1957 Packard.....\$700.00 ea.

#1323209 Left, includes apron. 1957 Packard....\$800.00 ea.

1326408 Right. 1958 J-body hardtop, sedan & station wagon. All except Scotsman ...\$450.00 ea.

1326409 Left. 1958 J-body hardtop, sedan & station wagon. All except Scotsman ...\$450.00 ea.

1328248 Right. 1958 Scotsman\$400.00 ea.

1328249 Left. 1958 Scotsman\$400.00 ea.

1358146 Right. 1964-66 Lark\$225.00 ea.

1358147 Left. 1964-66 Lark.....\$225.00 ea.

UPPER RADIATOR AIR DEFLECTORS (0502-84)

284344 1947-48 Champion\$65.00 ea.

#289415 1947-48 Champion. Can substitute for 284344\$65.00 ea.

#289575 1950 Champion\$90.00 ea.



#290488 1949 Champion ...\$70.00 ea.



293694 1951 All\$70.00 ea.



296206 1952 All\$65.00 ea.



297776 1953-54 All except C & K\$60.00 ea.



285810 1947-49 Commander.....\$60.00 ea.



308093 1955 All except C & K\$65.00 ea.



308223 1955 C & K.....\$90.00 ea.



#1312925 1956 sedan & station wagon.....\$70.00 ea.



#1328402 1958 Packard, all except Hawk.....\$70.00 ea.

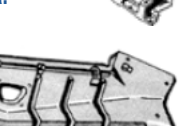

#1320063 All 1957 Studebakers except C & K. All 1957 Packard & 1958 Scotsman.....\$60.00 ea.

#1326498 1958 sedan & station wagon, all except Scotsman\$70.00 ea.

#1356110 1964 Lark all models & 1965-66 V-8\$175.00 ea.

#1361022 1965-66 6-cylinder.....\$65.00 ea.

*Can't find the part you're looking for?
Call & we'll be glad to look for a part
Just for you!*

(317) 462-3124

We welcome overseas customers!

- #267415** Left. 1938 President ..
.....**\$90.00 ea.**
- #267543** Right. 1938 Command-
er & Coupe Express.....**\$90.00 ea.**
- #267544** Left. 1938 Commander
& Coupe Express.....**\$90.00 ea.**
- #269426** Left. 1938-40 Commander & Coupe
Express.....**\$90.00 ea.**
- #269465** Right. 1939-40 President...**\$90.00 ea.**
- #269466** Left. 1939-40 President**\$90.00 ea.**
- #274850** Right. 1941-42 Commander.....
.....**\$75.00 ea.**
- #274852** Right. 1941-42 President...**\$75.00 ea.**
- #284385** Left. 1947-49 Champion. Includes
battery box.....**\$120.00 ea.**



FRONT FENDER APRONS

- #285946** Left. 1947-49 Commander. Includes
battery box. Same as 287891 Replacement piece.
.....**\$120.00 ea.**
- #287524** Right. 1947-49 Champion...**\$75.00 ea.**
- #287890** Right. 1947-49 Commander.....
.....**\$75.00 ea.**
- #287891** Left. Includes battery box. 1947-49
Commander. Same as 285946**\$120.00 ea.**
- #298402** Right. 1953-55 sedan & station
wagon**\$75.00 ea.**
- #298403** Left. 1953-55 sedan & station wagon.
Includes battery box**\$120.00 ea.**
- #1323178** Right. 1956-58 All except C&K
.....**\$83.75 ea.**
- #1323179** Left. 1956-58 All except C&K.....
.....**\$129.00 ea.**

- #1323188** Right. 1953-62 C & K....**\$200.00 ea.**
- #1323189** Left. 1953-62 C & K.....**\$200.00 ea.**
- #1331752** Right. 1959-60 Lark**\$95.00 ea.**
- #1331753** Left. 1959-60 Lark.....**\$75.00 ea.**
- #1331752** Right. 1959-60 Lark.....**\$95.00 ea.**
- #1331753** Left. 1959-60 Lark**\$75.00 ea.**
- #1338564** Right. 1961-63 Lark**\$65.00 ea.**
- #1338401** Left front. 1961 Lark.....**\$75.00 ea.**
- #1343011** Left. 1961-62 Lark.....**\$75.00 ea.**
- #1343015** Left. 1962 Lark with heavy duty
battery**\$75.00 ea.**
- #1353855** Left. 1963 Lark with heavy duty
battery**\$75.00 ea.**
- #1353857** Left. 1963 Lark.....**\$65.00 ea.**
- #1356084** Right. 1964-66 Lark.....**\$65.00 ea.**
- #1356085** Left. 1964-66 Lark.....**\$75.00 ea.**

- #308410** Right. 1955 C & K..
.....**\$90.00 ea.**
- #612556** Right. 1955 sedan
& station wagon**\$70.00 ea.**
- #612557** Left. 1955 sedan &
station wagon.....**\$70.00 ea.**
- 1320036** Right. 1956-57 All
except C & K.....**\$70.00 ea.**
- 1320037** Left. 1956-57 All except C & K.....
.....**\$70.00 ea.**
- 1320236P** Right. 1958 Scotsman ...**\$80.00 ea.**
- 1320237P** Left. 1958 Scotsman.....**\$80.00 ea.**
- #1326426** Right. 1958 All except Scotsman ...
.....**\$80.00 ea.**
- #1326427** Left. 1958 All except Scotsman.....
.....**\$80.00 ea.**

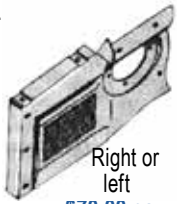

Right or
left

FRONT FENDER AIR DEFLECTORS

- 1331762P** Right. 1959-60 Lark. All except
convertible**\$90.00 ea.**
- 1331763P** Left. 1959-60 Lark. All except
convertible**\$120.00 ea.**
- 1337306** Right. 1960 Lark convertible
.....**\$70.00 ea.**
- 1338420** Right. 1961-63 Lark. All except con-
vertible & 1963 station wagon.....**\$40.00 ea.**
- 1338421** Left. 1961-63 Lark. All except con-
vertible & 1963 station wagon.....**\$40.00 ea.**
- 1339110** Right. 1961 Lark convertible.....
.....**\$70.00 ea.**
- 1339111** Left. 1961 Lark convertible.....
.....**\$70.00 ea.**
- #1342706** Right. 1962-63 Lark convertible &
1963 station wagon.....**\$75.00 ea.**

- 1342707** Left. 1962-63 Lark convertible & 1963
station wagon.....**\$75.00 ea.**
- 1353648** Right. 1963-64 Hawk.....**\$120.00 ea.**
- 1358166** Right. 1964-66 Single Headlight Lark
station wagon w/sliding roof.....**\$49.00 ea.**
- 1358167** Left. 1964-66 Single Headlight Lark
station wagon with sliding roof.....**\$49.00 ea.**
- 1358168** Right. 1964-65 Lark convertibles &
station wagon with sliding roof.....**\$70.00 ea.**
- 1358169** Left. 1964-65 Lark convertibles &
station wagon with sliding roof.....**\$70.00 ea.**
- 1358171** Left. 1964-66 Single Headlight Lark
except sliding roof station wagon.....**\$49.00 ea.**
- 1358172** Right. 1964-66 Dual Headlight cars
except sliding roof station wagon.....**\$40.00 ea.**
- 1358173** Left. 1964-66 Dual Headlight cars
except sliding roof station wagon.....**\$75.00 ea.**

FRONT LOWER PANELS, AIR DEFLECTORS, OR SPLASH GUARDS

(0502-89)

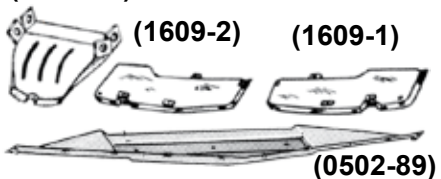

**Note: # Symbol indicates limited
availability on a new stocked piece.
Please call (317) 462-3124.**

- #269687P** Air deflector. 1937-38 All. (0502-89)
.....**\$75.00 ea.**
- #281306** Right front lower. 1942 Commander &
President. (1609-1)**\$65.00 ea.**
- #281307** Left front lower splash guard. 1942
Commander & President. (1609-2)**\$65.00 ea.**
- #281398** Right front lower. 1942-46 Champion.
(1609-1)**\$65.00 ea.**
- #281399** Left front lower splash guard. 1942-46
Champion. (1609-2).....**\$65.00 ea.**

- #288777** Right front lower splash guard, front
fender lower panel to bumper. 1948 Commander.
(1609-2)**\$65.00 ea.**
- #288778** Left front lower splash guard, front
fender lower panel to bumper. 1948 Commander.
(1609-2)**\$65.00 ea.**
- #290248** Right splash guard, front fender lower
panel to bumper. 1949 Commander & Land Cruiser.
(1609-1)**\$71.50 ea.**
- #290249** Left front splash guard, lower panel to
bumper. 1949 Commander & Land Cruiser (1609-2)
.....**\$71.50 ea.**

(1601-15-2)

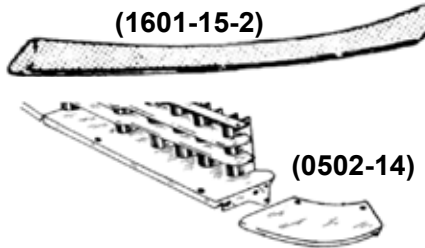

(0502-14)

- #290122** Front lower panel, air deflector. 1950
Commander. (0502-31)**\$75.00 ea.**
- #290124** Front lower panel, air deflector. 1950
Commander. (0502-31)**\$75.00 ea.**
- #290126** Right lower grill extension. 1949 Cham-
pion. Painted. (0502-13).....**\$25.00 ea.**
- #290127** Left lower grill extension. 1949 Cham-
pion. Painted. (0502-14).....**\$25.00 ea.**

- #293234** Front lower
splash guard. 1951 all cars.
(1609-3) Used but in solid
condition.**\$85.00 ea.**

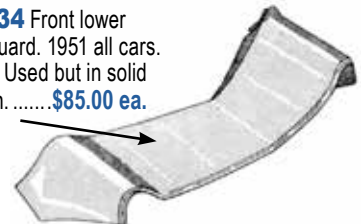

- #308147P** Lower scoop. 1955 with
wraparound windshield, all except C&K.....
.....**\$250.00 ea.**
- 296218P** Center air deflector. 1952 all.
.....**\$125.00 ea.**

(0502-91)



(0502-92)

- 1312840** Right air deflector. 1956 all except
C & K. (0502-91).....**\$75.00 ea.**
- #1312841** Left air deflector. 1956 All except
C & K. (0502-92).....**\$75.00 ea.**

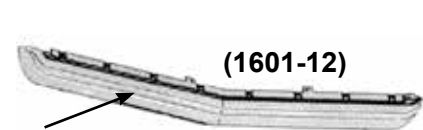

(1601-12)

- 1356000** Air deflector. 1964-66 Lark. (1601-12).
.....**\$75.00 ea.**

- 286144** Right splash guard. 1947 Commander.
(1609-1).....**\$65.00 ea.**
- #286145** Left front lower splash guard, front
fender lower panel to bumper. 1947 Commander.
(1609-2)**\$65.00 ea.**

Continued

FRONT LOWER PANELS, AIR DEFLECTORS, OR SPLASH GUARDS

Continued

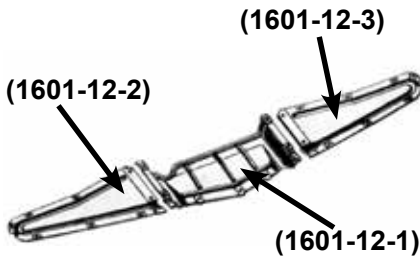

- #1312902 Right air deflector. 1956-58 sedan & station wagon. (1601-12-2)..... **\$45.00 ea.**
- #1312903 Left air deflector. 1956-58 sedan & station wagon. (1601-12-3)..... **\$45.00 ea.**
- #1312905 Center air deflector. 1956-58 sedan & station wagon. (1601-12-1)..... **\$65.00 ea.**
- #1320068 Center lower air intake. 1957-58 sedan. (1601-12-1)..... **\$65.00 ea.**

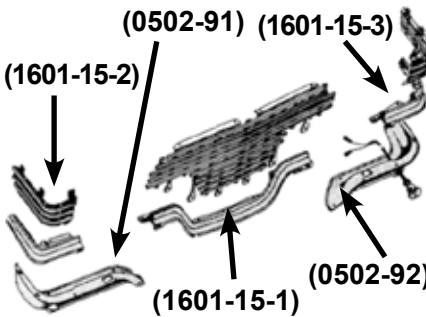

- #1320056P Right air deflector. 1957-58, all except C & K (1601-15-2)..... **\$35.00 ea.**
- #1320057P Left air deflector. 1957-58 all except C & K (1601-15-3)..... **\$35.00 ea.**
- #1326014 Right air deflector. 1958 all except C & K. (0502-92)..... **\$75.00 ea.**
- #1326015 Left air deflector. 1958 all except C & K. (0502-92)..... **\$75.00 ea.**
- #1326550 Center air deflector. 1957-58 all except C & K (1601-15-1)..... **\$65.00 ea.**



#1328096 Right P-Y-J. 1958 Packard. (0502-24)..... **\$150.00 ea.**



#1328426 Front lower air deflector extension. 1958 Packard sedan & J-body hardtop. (1601-15-6)..... **\$90.00 ea.**

REAR FENDERS AND QUARTER PANELS

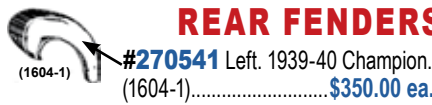

#270541 Left. 1939-40 Champion. (1604-1)..... **\$350.00 ea.**

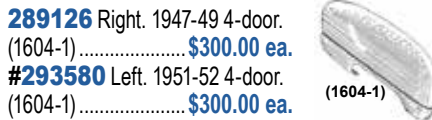

289126 Right. 1947-49 4-door. (1604-1)..... **\$300.00 ea.**

#293580 Left. 1951-52 4-door. (1604-1)..... **\$300.00 ea.**

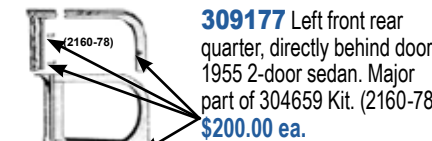

309177 Left front rear quarter, directly behind door. 1955 2-door sedan. Major part of 304659 Kit. (2160-78) **\$200.00 ea.**

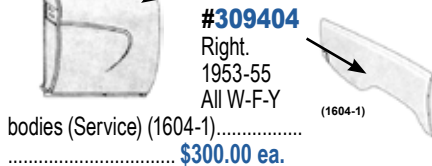

#309404 Right. 1953-55 All W-F-Y

bodies (Service) (1604-1)..... **\$300.00 ea.**



#1316037 Left. 1956 sedan 4-door. (2160-78)..... **\$300.00 ea.**

#1316047 Left. 1956 sedan 2-door. (2160-78)..... **\$350.00 ea.**

#1320103 Left. 1957 4-door station wagon (2160-78)..... **\$450.00 ea.**

#1323418 Right. 1957 Packard 4-door. (2160-78)..... **\$300.00 ea.**

#1323419 Left. 1957 Packard 4-door. (2160-78) **\$300.00 ea.**

#1326754 Right. 1958 Packard 4-door. (2160-78)..... **\$300.00 ea.**

#1326772 Right. 1958 sedan 4-door. (2160-78)..... **\$150.00 ea.**

#1326773 Left. 1958 sedan 4-door. (2160-78)..... **\$150.00 ea.**

#1328126 Right. 1958 sedan 4-door. (S1326772) (2160-78)..... **\$150.00 ea.**

#1328129 Left. 1958 2-door sedan (Not illustrated)..... **\$250.00 ea.**

#1320232 Right, rear quarter, outer panel. 1957 2-door station wagon..... **\$450.00 ea.**

#1320233 Left, rear quarter, outer panel. 1957 2-door station wagon..... **\$450.00 ea.**

#1323056 Right, rear quarter overlay. 1957. Packard wagon. (2560-80)..... **\$300.00 ea.**

#1323396 Right lower. 1957 Packard 4-door wagon. Not illustrated. **\$200.00 ea.**

#1326084 Right. 1958 B & H P4 station wagon. (2160-78)..... **\$450.00 ea.**

#1326085 Left. 1958 B & H P4 station wagon. (2160-78)..... **\$450.00 ea.**

1331452 Right 1959-60 Lark 4-door. 1604-1..... **\$150.00 ea.**

1331453 Left. 1959-60 Lark 4-door. (1604-1)..... **\$150.00 ea.**

1331458 Right. 1959-60 Lark 2-door. (1604-1)..... **\$350.00 ea.**

1331459 Left. 1959-60 Lark 2-door. (1604-1)..... **\$350.00 ea.**

1335136 Right. 1964-66 Lark 4-door. (1604-1)..... **\$150.00 ea.**

1335137 Left. 1964-66 Lark 4-door. (1604-1)..... **\$150.00 ea.**

1331782 Right 1959 2-door station wagon. (2160-78)..... **\$450.00 ea.**

#1331783 Left. 1959 2-door station wagon. (2160-78)..... **\$450.00 ea.**

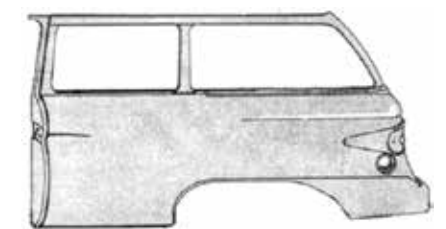

1331785 Outside repair only, left. 1959 2-door station wagon. (Not illustrated)..... **\$350.00 ea.**

1336008 Right. 1960 2-door station. (2160-78)..... **\$450.00 ea.**

1336009 Left. 1960 2-door station wagon. (2160-78)..... **\$450.00 ea.**

#1338502 Right. 1961 2-door station wagon. (2160-78)..... **\$450.00 ea.**

#1338503 Left. 1961 2-door station. (2160-78)..... **\$450.00 ea.**

#1338504 Outside repair, right. 1961 2-door station wagon. (Not illustrated)..... **\$350.00 ea.**

1337002 Right. 1960 4-door station wagon. (2160-78)..... **\$450.00 ea.**

1337003 Left. 1960 4-door station wagon. (2160-78)..... **\$450.00 ea.**

#1339492 Right. 1961 4-door station wagon. (2160-78)..... **\$250.00 ea.**

#1339493 Left. 1961 4-door station wagon. (2160-78)..... **\$250.00 ea.**

#1342542 Right. 1962 4-door station wagon. (2160-78)..... **\$250.00 ea.**

#1342543 Left. 1962 4-door station wagon. (2160-78)..... **\$250.00 ea.**

1338602 Right. 1961 Lark 2-door. (1604-1)..... **\$450.00 ea.**

1338603 Left. 1961 Lark 2-door. (1604-1)..... **\$450.00 ea.**

#1338604 Right. 1961 Lark 4-door. (1604-1)..... **\$150.00 ea.**

1338605 Left. 1961 Lark 4-door. (1604-1)..... **\$150.00 ea.**

1352730 Right. 1963 Lark 4-door. (1604-1)..... **\$158.00 ea.**

1352731 Left. 1963 Lark 4-door. (1604-1)..... **\$158.00 ea.**

1356136 Right. 1964-66 Lark 4-door. (1604-1)..... **\$150.00 ea.**

1356137 Left. 1964-66 Lark 4-door. (1604-1)..... **\$150.00 ea.**

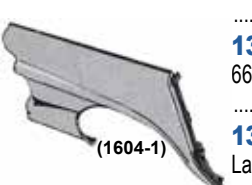
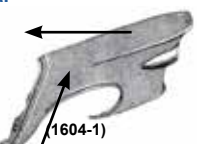
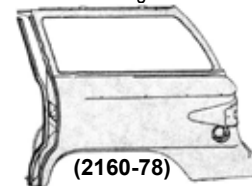
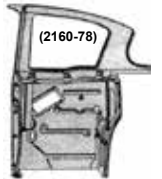

REAR FENDER FINS

- #1312590** Right. 1956 station wagon.....
.....\$200.00 ea.
- 1312591** Left. 1956 station wagon.....
.....\$200.00 ea.
- #1320806P** Right. 1957-68 Silver Hawk....
.....\$275.00
- #1326250** Right. 1958 Deluxe hardtop. (J-4)
.....\$250.00 ea.
- #1326251** Left. 1958 Deluxe hardtop. (J-4)
.....\$250.00 ea.
- 1326254** Right. 1958 Regal hardtop. (J-6).....
.....\$250.00 ea.
- 1326255** Left. 1958 Regal hardtop. (J-6).....
.....\$250.00 ea.
- #1326260** Right. 1958 Deluxe sedan, 4-door....
.....\$250.00 ea.
- #1326264** Right. 1958 Deluxe sedan, 4-door ...
.....\$200.00 ea.
- #1326268** Right. 1958 President classic, 4-door
.....\$200.00 ea.
- #1326269** Left. 1958 Packard sedan, 4-door...
.....\$200.00 ea.
- #1326272** Right. 1958 Packard J-body hardtop
.....\$250.00 ea.
- #1327742** Right. 1958 Packard station wagon..
.....\$200.00 ea.
- #1327743** Left. 1958 Packard station wagon ...
.....\$200.00 ea.
- 1327744** Right. 1958 Provincial station wagon .
.....\$200.00 ea.
- #1339147** Left. 1961 Hawk\$275.00 ea.



REAR GRAVEL DEFLECTORS

(1610-1)

- #281637** 1942 Commander & President.....
.....\$100.00 ea.
- #520455** 1947 cars all models & 1948 Com-
mander.....\$95.00 ea.
- #533578** To frame. 1953 cars.....\$95.00 ea.
- #1544601** 1958-64 Hawks with single exhaust.
.....\$75.00 ea.
- #1548359** Early 1959 station wagon.....
.....\$75.00 ea.
- 1549239** 1959-60 Lark, all models except
station wagon.....\$120.00 ea.
- 1549241** Rear deflector, mounts under rear
bumper. 1959-62 station wagon.....\$75.00 ea.
- 1550734** 1961 Lark, all models except station
wagon.....\$65.00 ea.
- 1557890** Rear deflector, mounts under rear
bumper. 1963-65 station wagon.....\$75.00 ea.



REAR SPLASH GUARDS

Bumper to Body (1610-3)

- #274477** 1941 Champion.....\$95.00 ea.
- 274974** Rear gravel deflector rubber pad.
1953-54 all models. Takes 5.....85¢ ea.
- 287427** Rear gravel deflector rubber pad.
1955 sedan & 1956-64 C & K car, includes
Hawk. Takes 5.....\$3.00 ea.
- #288757** 1947 Champion & Commander. Same
as 290815.....\$85.00 ea.
- #290815** 1947-48 Champion & all 1949 cars....
.....\$85.00 ea.
- #297463P** 1953-54 sedan.....\$85.00 ea.
- #305748** Center section, 1955-56 2-door station
wagon.....\$75.00 ea.
- 308644** Center section, 1955 sedan, all.....
.....\$75.00 ea.

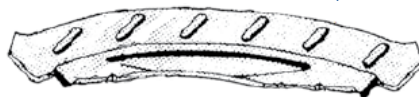

(2560-138)

- #1320130** 1957-58 Scotsman 2-door station
wagon.....\$85.00 ea.
- 1320131** 1957-58 station wagon all except
Scotsman 2-door.....\$75.00 ea.
- 1331529** 1959-60 station wagon.....\$75.00 ea.
- 1338574** 1961-62 station wagon.....\$75.00 ea.
- 1353637** 1963-66 station wagon.....\$65.00 ea.

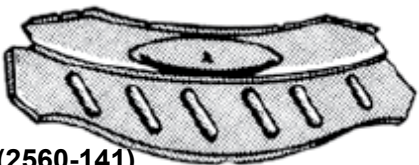

(2560-141)

- #1323280** Center section 1957-58 Packard
station wagon. (2560-141).....\$85.00 ea.

Returning parts?

Please include a copy of your invoice with your return. There is a \$5.00 "Invoice Search" fee for items returned without one.

BODY SEAM FILLER/WELT

800587X25

1947-52 rear fender to body flexible beading.
25ft roll. Easy to paint
.....\$48.00 ea.



- 1320196-7** 1953-55 C & K and 1956-61 Hawk. Metal 'T' shaped strip that fits between rear fender and body below rear quarter window. 16" long.....\$20.00 ea.

FENDER CORNER SEALS

Note: Seals between front inner fender and cowl. Takes 2.

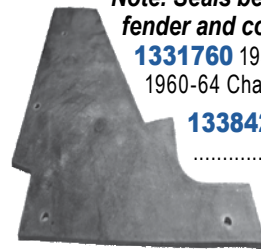

- 1331760** 1959-60 Lark. Truck:
1960-64 Champ.....\$13.25 ea.
- 1338424** 1961-66 Lark
.....\$10.00 ea.
- 1483X1** Clip. All ..
.....\$2.00 ea.

SPEED - NUT

- 1331874** Special-nut, rear fender to body, 1959-66 Lark.....\$3.00 ea.

Note:
Symbol indicates limited availability on a new stocked piece.
() Denotes parts book illustration number.

FIREWALL (2160-37)

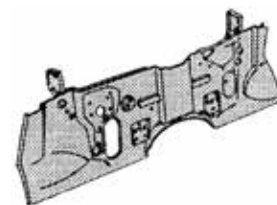

- #1312331** Firewall panel. 1955-57 sedan with wraparound windshield.....
.....\$200.00 ea.
- #1331598** Firewall panel for left hand drive car. 1959-60 Lark.....\$200.00 ea.
- 1332422** Firewall panel. 1959-62 Hawk.....
.....\$300.00 ea.
- #1337329** Firewall panel for right hand drive car. 1960 Lark.....\$100.00 ea.
- #1338251** Firewall panel for right hand drive car. 1961-62 Lark.....\$100.00 ea.
- #1338252** Firewall panel for left hand drive car. 1961-62 Lark.....\$200.00 ea.

MOULDING & ROCKER PANEL CLIPS

289138 Moulding clip. Rocker panel, all 1949-52 cars with rocker panel mouldings.....\$3.95 ea.



- 296514G** Clip. Top of door & rear quarter cast moulding. All 1953 & early 1954 cars with snap-type clip on back of Moulding.....\$2.00 ea.



REAR WHEEL HOUSE AND REAR FENDER INNER GRAVEL DEFLECTOR PANELS

#298146 Rear quarter inner deflector panel - fits between left rear tire and gas tank filler pipe, 1953-54 sedan. (1604-10)..... **\$75.00 ea.**
#609384 Right. 1947-49 2-door (2160-11)..... **\$450.00 ea.**

#609386 Right. 1947-49 Starlite Coupe. **\$450.00 ea.**

#609387 Left. 1947-49 Starlite Coupe. **\$450.00 ea.**

#610607 Left. 1950-52 4-door. ... **\$300.00 ea.**

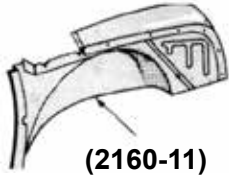

(2160-11)

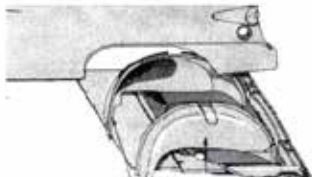

(2160-98) (2160-100) (2160-123)

#1336238 Right outer. 1960 Lark station wagon 2 & 4-door. (2160-100)..... **\$125.00 ea.**

#1336239 Left outer. 1960 Lark station wagon 2 & 4-door. (2160-100)..... **\$125.00 ea.**

#1338522 Right outer. 1961-62 station wagon 2 & 4-door. (2160-100)..... **\$125.00 ea.**

#1338523 Left outer. 1961-62 station wagon 2 & 4-door. (2160-100)..... **\$125.00 ea.**

#1338590 Right inner. 1961-62 station wagon 2 & 4-door. (2160-98)..... **\$125.00 ea.**

#1338591 Left inner. 1961-62 station wagon 2 & 4-door. (2160-98)..... **\$125.00 ea.**

#1352766 Right inner. 1963-66 station wagon. (2160-98)..... **\$125.00 ea.**

#1352834 Right outer. 1963-66 station wagon. (2160-100)..... **\$125.00 ea.**

#266975 Left rear fender gravel deflector panel, 1938-40 car all except Champion. (1604-10)..... **\$75.00 ea.**



(1604-10)

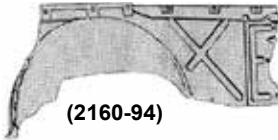

(2160-94)

#1316116 Right. 1956-58 sedan. 2 & 4-door. **\$250.00 ea.**

#1327338 Right. 1958 J-body hardtop. **\$350.00 ea.**

#1327339 Left. 1958 J-body hardtop..... **\$350.00 ea.**

#1331578 Right. 1959 Lark hardtop..... **\$350.00 ea.**

1336921 Left. 1960 Lark sedan 4-door. **\$250.00 ea.**

#1336923 Left. 1960 Lark sedan 2-door. **\$350.00 ea.**

#1338342 Right. 1961 Lark sedan 2-door. **\$350.00 ea.**

#1338343 Left. 1961 Lark sedan 2-door. **\$350.00 ea.**

#1338347 Left. 1961 Lark hardtop..... **\$350.00 ea.**

1342351 Left. 1962-63 Lark 2-door sedan. **\$350.00 ea.**

REAR QUARTER ROOF REINFORCEMENT PANELS

#1336588 Right rear quarter inner. 1960 convertible (2160-81-1). **\$75.00 ea.**

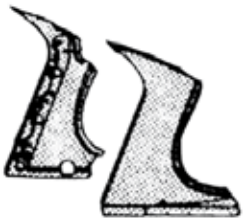

#1336589 Left rear quarter inner. 1960 convertible. (2160-81-1)..... **\$75.00 ea.**

#1338014 Right rear quarter inner. 1961 convertible. (2160-81-1)..... **\$75.00 ea.**

#1338015 Left rear quarter inner. 1961 convertible. (2160-81-1)..... **\$75.00 ea.**

#1338166 Right rear quarter outer. 1961 hardtop (2160-80)..... **\$50.00 ea.**

#1338167 Left rear quarter outer. 1961 hardtop (2160-80)..... **\$50.00 ea.**

#1338168 Right rear quarter inner. 1961 hardtop (2160-80)..... **\$50.00 ea.**

#1338248 Right rear quarter outer. 1961 sedan 4-door, Short wheel base. (2160-80)..... **\$50.00 ea.**

#1338249 Left rear quarter outer. 1961 sedan 4-door, Short wheel base. (2160-80)..... **\$50.00 ea.**

#1342320 Right rear quarter outer. 1962 Cruiser (2160-81)..... **\$50.00 ea.**

1342321 Left rear quarter outer. 1962 Cruiser (2160-81)..... **\$50.00 ea.**

#1342324 Right rear quarter outer. 1962 Hardtop (2160-81)..... **\$50.00 ea.**

#1342325 Left rear quarter outer. 1962 Hardtop (2160-81)..... **\$50.00 ea.**

#1342326 Right rear quarter inner. 1962 Hardtop (2160-80)..... **\$55.00 ea.**

#1342327 Left rear quarter inner. 1962 Hardtop (2160-80)..... **\$55.00 ea.**

#1352416 Right rear quarter inner. 1963 Hardtop (2160-80)..... **\$55.00 ea.**

#1352417 Left rear quarter inner. 1963 Hardtop (2160-80)..... **\$55.00 ea.**

INNER FENDER SPLASH APRON

304810 1953-55 All models, left or right side **\$18.50 ea.**

801930 Steel Staples to adhere splash apron to fender **\$2.25 set of 20**

1331759 1956-66 All models, left or right side **\$18.50 ea.**



1656314 Truck: 1960-64 Champ. Right side.... **\$28.75 ea.**

1656315 Truck: 1960-64 Champ. Left side **\$28.75 ea.**

1655462 Truck: 1960-64 Champ. **\$28.75 ea.**

..... **\$28.75 ea.**

TRUNK OPENING REAR PANELS

(2160-16)

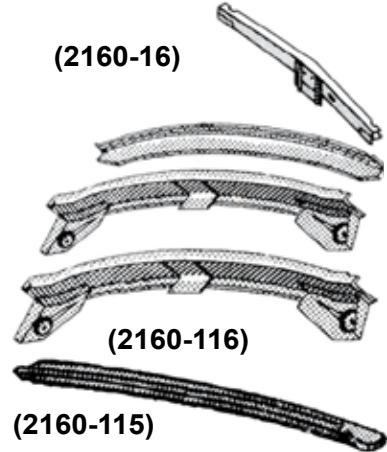

(2160-116)

(2160-115)

#287959 Lower deck opening rear panel. Late 1947-49 car..... **\$65.00 ea.**

#297796 Lower deck opening rear panel. Possibly for early 1947 car..... **\$65.00 ea.**

#304657 1953-55 sedan, all models. 2-piece kit..... **\$150.00 ea.**

#308128 1953-64 C & K car..... **\$295.00 ea.**

1320418 1956-58 sedan, 2 & 4-door..... **\$125.00 ea.**

#1323303 1957-58 Packard, 4-door **\$160.00 ea.**

1316003 Lower deck opening rear panel, 1956 sedan. Part of 1312548 panel kit..... **\$160.00 ea.**

#1323079 Largest piece of 1320519 lower deck kit. 1957-58 Packard sedan. **\$200.00 ea.**

#1323474 Largest piece of 1320518 Lower deck kit. 1957-58 Packard sedan. (2160-115)..... **\$200.00 ea.**

1338100 1961 Lark, all models **\$175.00 ea.**

1342700 1962 Lark, all models **\$175.00 ea.**

1356575 1964-65 Lark, all models **\$175.00 ea.**

1362090 1966 sedan, all models. **\$175.00 ea.**

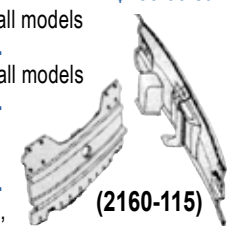

(2160-115)

DOOR SKINS

4-DOOR VEHICLE (FRONT)

308018 Right. 1961-62 Lark **\$300.00 ea.**

#308019 Left. 1961-62 Lark **\$350.00 ea.**

#1352012 Right. 1963-66 Lark **\$350.00 ea.**

#1352013 Left. 1963-66 Lark **\$350.00 ea.**

4-DOOR VEHICLE (REAR)

1331444 Right rear, 1961 Lark Cruiser **\$200.00 ea.**

1331445 Left rear, 1961 Lark Cruiser..... **\$200.00 ea.**

#1342302 Right rear, 1962 Lark Cruiser **\$250.00 ea.**

1352008 Right rear, 1963 Lark sedan..... **\$200.00 ea.**

1352009 Left, rear, 1963 Lark sedan **\$200.00 ea.**

1358534 Right, rear, 1964-66 Lark sedan..... **\$200.00 ea.**

#1358535 Left rear, 1964-66 Lark sedan..... **\$200.00 ea.**

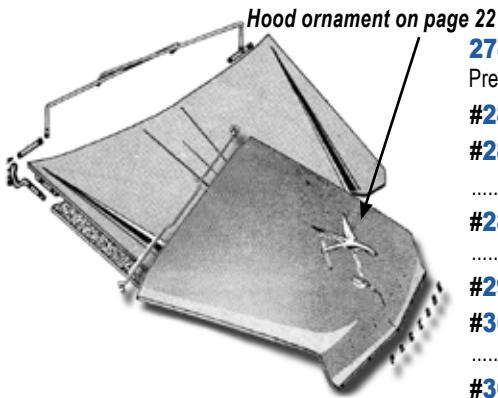

HOOD & SIDE PANELS

- 274467** Left, hood side panel. 1941-42 President.....\$90.00 ea.
#284106 Hood. 1947 Champion ..\$650.00 ea.
#285649 Hood. 1947-49 Commander.....\$600.00 ea.
#289501 Hood. 1950 Commander.....\$800.00 ea.
#292530 Hood. 1951 All.....\$800.00 ea.
#308063 Hood. 1955 C & K. (K5).....\$700.00 ea.
#308084P Hood. 1955 sedan without wraparound windshield (GF).....\$800.00 ea.
308461 Hood. 1955 car with wrap around windshield (GF).....\$425.00 ea.
#1312008 Hood. 1956 sedan & station wagon ..\$600.00 ea.
#1327512P Hood, skin only. 1958 sedan.....\$450.00 ea.
#1328084 1958 Packard, all except Hawk.....\$300.00 ea.
#1331316 Panel hood top front reinforcement. 1959-60 Lark.....\$75.00 ea.
#1338051P 1961 Lark.....\$450.00 ea.
1342505 1962-63 Lark.....\$225.00 ea.
1356192 Right torsion bar. 1964-66 Lark.....\$65.00 ea.
1356193 Left torsion bar. 1964-66 Lark.....\$65.00 ea.
#1358424P Hood. 1964-66 Lark. \$450.00 ea.

- 272829** Left, hood side panel. 1940 Champion.....\$90.00 ea.
274466 Right, hood side panel. 1941-42 President.....\$90.00 ea.

ROOF AREA PANELS

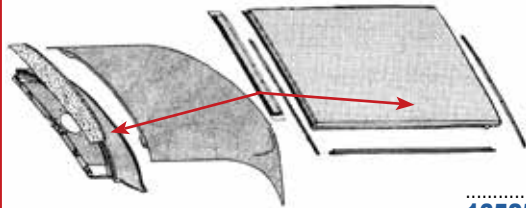

- #304656** Roof Assembly. 1953-61 Coupe & hardtop. (2160-1).....\$500.00 ea.

- #1339618** Roof Assembly. 1961-62 4-door and 2 door sedan & J-body hardtops with sliding roof. (2160-1).....\$500.00 ea.
1343573 Rear upper deck opening panel. Includes rear package shelf support. 1962-64 GT Hawk. (2160-106).....\$175.00 ea.
1352531 Station wagon Sliding roof rear section. The part that actually slides. 1963-66 Models (2169-600).....\$325.00 ea.
#1353630 Roof Assembly 1962-64 GT Hawk. (2160-1).....\$500.00 ea.
#1353955 Roof Assembly. 1963 sedan 4-door with sliding roof. (Sky top) (2160-1).....\$450.00 ea.
#1355402 Station wagon rear roof section. 1963-66 Models with non-sliding roof. (2160-1).....\$200.00 ea.

2-DOOR

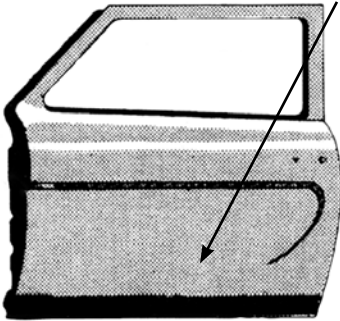

- #282340** Right. 1941-46 Champion Sedan.....\$650.00 ea.
#282341 Left. 1941-46 Champion Sedan.....\$650.00 ea.
#298056 Right. 1953-55 Sedan with straight windshield.....\$450.00 ea.
#298057 Left. 1953-55 Sedan with straight windshield.....\$450.00 ea.

4-DOOR FRONT

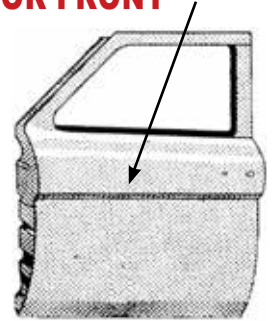

- #1314669** Left. 1956 K-body Hawk.....\$800.00 ea.
1320574 Right. 1957-64 K - Hawk.....\$650.00 ea.
1320600 Right. 1957-62 Sedan.....\$450.00 ea.
1320601 Left. 1957-62 Sedan.....\$450.00 ea.
1320603 Left. 1957-58 station wagon.....\$450.00 ea.
#1327622 Right. 1958 J-body hardtop.....\$450.00 ea.
#1327623 Left. 1958 J-body hardtop.....\$450.00 ea.
#1331276 Right. 1959-61 C-Coupe.....\$650.00 ea.
1331277 Left. 1959-61 C-Coup.....\$650.00 ea.
1352186 Right. 1963-66 Lark sedan.....\$375.00 ea.
1352189 Left. 1963-64 hardtop & convertible.....\$550.00 ea.
#292388 Right. 1950-52.....\$450.00 ea.
#292389 Left. 1950-52.....\$450.00 ea.
#298050 Right. 1953-55 sedan with straight windshield.....\$450.00 ea.
#298051 Left. 1953-55 sedan with straight windshield.....\$450.00 ea.
1314628 Right. 1956 sedan.....\$400.00 ea.
#1314629 Left. 1956 sedan.....\$600.00 ea.
#1323161 Left. 1957-58 sedan.....\$450.00 ea.
#1323370 Right. 1957-58 station wagon. Upper corner is damaged.....\$450.00 ea.
#1323371 Left. 1957-58 station wagon.....\$450.00 ea.
1336050 Right. 1959-62 station wagon.....\$400.00 ea.
1336051 Left. 1959-62 station wagon.....\$400.00 ea.
1352180 Right. 1963-66 sedan & station wagon.....\$300.00 ea.

TRUNK LIDS

- #299765** 1953 sedan 2 & 4-door...\$400.00 ea.
#306164 1954-55 C-Coupe.....\$650.00 ea.
1316120 1956 Sedan 2 & 4-door. \$250.00 ea.
1323536 1957-58 2-door Scotsman 2 & 4-door Sedan.....\$250.00 ea.
#1331340 1959-60 Lark all models.....\$550.00 ea.
1338057 1961 Lark all models except Y-1 4-door.....\$250.00 ea.
#1338058 1961 Lark 4-door Y-1...\$250.00 ea.
1342468 1962 Lark 4-door Y-1.....\$250.00 ea.
#1352261 1963 Lark Y-1 4-door...\$250.00 ea.
#1355225 1963 Lark Y-2 & F-2 sedan.....\$250.00 ea.
#1361140 1962-63 Lark all models except Y-1 4-door.....\$250.00 ea.

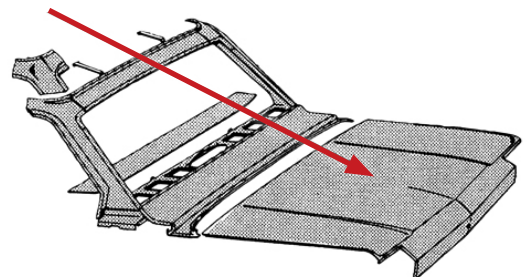

symbol indicates limited availability on a NOS piece. () denotes parts book illustration number.

SILL OR ROCKER PANELS

- #278430 Right. Early 1941 Champion 4-door ... \$150.00 ea.
- #278431 Left. Early 1941 Champion 4-door..... \$150.00 ea.
- #278432 Right. Early 1941 Champion 2-door sedan..... \$150.00 ea.
- #278435 Left. Early 1941 Champion Business Coupe..... \$150.00 ea.
- #278437 Left. 1941 Commander & President... \$150.00 ea.
- #280862 Right. Late 1941-46 Champion 2-door sedan..... \$150.00 ea.
- #286026 Right. 1947-Early 1948 Land Cruiser.. \$120.00 ea.
- #286388 Right. 1947-52 4-door sedan. W-1 & W-3 bodies..... \$120.00 ea.
- #286389 Left. 1947-52 4-door sedan, ...W-1 & W-3 bodies..... \$120.00 ea.
- #289140 Right. 1948-52 4-door sedan W5 body..... \$120.00 ea.
- #289142 Right. 1948-52 4-door, Land Cruiser. \$120.00 ea.

- #297568 Right. 1953-58 Land Cruiser & President Classic \$120.00 ea.
- #297569 Left. 1953-58 Land Cruiser & President Classic..... \$120.00 ea.
- #298609 Left. 1953-58 2-door sedan..... \$120.00 ea.
- #1331888 Right. 1959-60 Lark 2-door, all except C & K car..... \$120.00 ea.
- #1331889 Left. 1959-60 Lark 2-door, all except C & K car..... \$120.00 ea.
- 1331894 Right. 1959-60 Lark 4-door sedan \$150.00 ea.
- 1331895 Left. 1959-60 Lark 4-door sedan..... \$120.00 ea.
- #1331896 Right. 1959-60 Lark 4-door, taxi long wheel base..... \$95.00 ea.
- #1331897 Left. 1959-60 Lark 4-door, taxi long wheel base..... \$95.00 ea.
- #1336276 Right. 1960 Lark 4-door station wagon..... \$95.00 ea.
- #1336277 Left. 1960 Lark 4-door station wagon..... \$95.00 ea.



- #1338279 Left. 1961-62 Lark 2-door station wagon..... \$95.00 ea.
- 1338282 Right. 1961 Lark 4-door, all except Cruiser..... \$95.00 ea.
- #1338283 Left. 1961 Lark 4-door, all except Cruiser..... \$95.00 ea.
- #1338285 Right. 1962 4-door sedan..... \$95.00 ea.
- 1343776 Right. 1953-64 C & K-body includes Hawk..... \$95.00 ea.
- 1343777 Left. 1953-64 C & K-body includes Hawk..... \$95.00 ea.
- #1353284 Right. 1963-66 station wagon..... \$95.00 ea.
- #1353285 Left. 1963-66 station wagon..... \$95.00 ea.
- #1353289 Left. 1963-66 4-door sedan..... \$95.00 ea.

Note: The above rocker panels are all the weld-type.

STATION WAGON TAILGATES & SURROUNDING PIECES

- 1320110 Right inner tail light mounting panel. 1957 wagon. Pictured..... \$75.00 ea.
- #1320111 Left inner tail light mounting panel. 1957 wagon (2160-88-6) .. \$75.00 ea.
- #1331532 Rear floor panel. 1959-60 station wagon 2 & 4-door..... \$700.00 ea.
- #1332738 Tailgate. Lower service. 1954-59 2-door wagon..... \$350.00 ea.
- #1339198 Rear floor panel. 1961-62 2 & 4-door wagon..... \$700.00 ea.
- #1352750 Rear floor panel. Early 1963 wagon..... \$700.00 ea.
- #1353991 Rear floor panel. Late 1963-66 wagon..... \$700.00 ea.
- 1357726 Tailgate. Lower service. 1961-62 2 & 4-door wagon..... \$350.00 ea.

(2160-88-6)

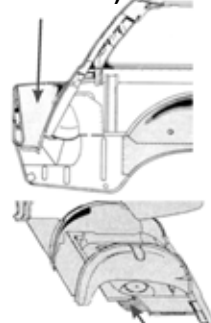

(2160-123)

(2131-72)

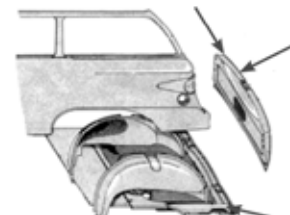

(2160-123)

symbol indicates limited availability on a NOS piece. () denotes parts book illustration number.

4-DOOR REAR

- #282364 Right. 1941-42 Commander & President..... \$300.00 ea.
- #291601 Left. 1947- early 1950 Land Cruiser \$300.00 ea.
- #292416 Right. 1951-52 sedan..... \$300.00 ea.
- #292417 Left. 1951-52 sedan..... \$300.00 ea.
- #292439 Left. 1951-52 Land Cruiser..... \$300.00 ea.
- #310266 Right. 1955 sedan..... \$300.00 ea.
- #310267 Left. 1955 sedan..... \$300.00 ea.
- #310268 Right. 1955 Land Cruiser..... \$300.00 ea.
- #1323162 Right. 1957 President Classic & Packard..... \$300.00 ea.
- 1323164 Right. 1957-58 sedan..... \$300.00 ea.



- #1323165 Left. 1957-58 sedan..... \$300.00 ea.
- #1323374 Right. 1957-58 station wagon..... \$300.00 ea.
- #1327344 Right. 1958 President Classic..... \$300.00 ea.
- #1327345 Left. 1958 President Classic..... \$300.00 ea.
- #1327375 Left. 1957-58 station wagon..... \$300.00 ea.
- #1336068 Right. 1959-60 Lark sedan..... \$300.00 ea.
- #1336069 Left. 1959-60 Lark sedan..... \$300.00 ea.
- 1336080 Right. 1959-62 station wagon..... \$300.00 ea.
- 1336081 Left. 1959-62 station wagon..... \$300.00 ea.

- 1336086 Right. 1959-61 Lark, taxi, & Cruiser... \$300.00 ea.
- 1336087 Left. 1959-61 Lark, taxi, & Cruiser..... \$300.00 ea.
- 1338334 Right. 1961 Lark, sedan .. \$300.00 ea.
- 1338335 Left. 1961 Lark, sedan..... \$300.00 ea.
- 1342292 Right. 1962 Lark, sedan .. \$300.00 ea.
- 1342293 Left. 1962 Lark, sedan..... \$300.00 ea.
- 1352190 Right. 1963-66 sedan & 1963 wagon. \$300.00 ea.
- 1352191 Left. 1963-66 sedan & 1963 wagon ... \$300.00 ea.
- #1358530 Right. 1964-66 station wagon..... \$300.00 ea.

FRAME TO BODY PADS

- 311446X2** 1/8" 1953-66 all models ... **\$2.50 ea.**
- 311446X4** 1/4" 1953-66 all models. **\$2.50 ea.**
- 311446X6** 1/2" 1953-66 all models **\$3.50 ea.**
- 653832-3** Truck body mounts. 1955-64 C-Cab & 1960-64 T - Cab truck **\$25.00/set 4**
- 802483** 1949-55 Truck cab mount spring set.... **\$23.00/set**



CENTER PILLAR POST (Rear Door Hinge Pillar)

- 284662** Right. 1947-52 all cars with 4-doors **\$150.00 ea.**
- 297290** Right. 1953 all cars with 4-doors **\$150.00 ea.**
- 308627** Left. 1953-55 car all cars with 4-doors **\$150.00 ea.**

1960-62 P-1 PICKUP BED PARTS T-CAB WITH OUTER FENDERS

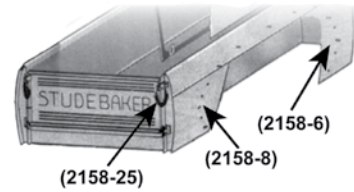

- 652384** Pickup bed. Right rear outer side panel with 6.5 ft. bed (2158-8)..... **\$95.00 ea.**
 - 652385** Pickup bed. Left rear outer side panel with 6.5 ft. bed (2158-8)..... **\$95.00 ea.**
 - #652530** Right front outside panel. 8 foot bed (2158-8) **\$75.00 ea.**
 - 652534** Right rear, outside panel. 8 foot bed (2158-8) **\$95.00 ea.**
 - #652535** Left rear, outside panel. 8 foot bed (2158-8) **\$95.00 ea.**
 - #1654013** Left rear, outside panel. 8 foot bed (2158-8) **\$95.00 ea.**
- 802513** 1949-64 set of White tailgate letters for trucks..... **\$44.95 set**

DOOR HINGE POST

**Denotes partial piece.*

- #607980** Right cowl side panel. 1941-42 Commander & President. (2160-5).... **\$160.00 ea.**
- #607981** Left cowl side panel. 1941-42 Commander & President. (2160-5).... **\$160.00 ea.**
- #609776** Right cowl side panel. 1947-52 convertible. (2360-5) **\$160.00 ea.**

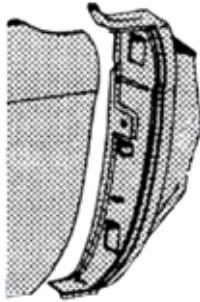

- #1330186** Left cowl or door hinge panel, fits 1958 sedan & J body hardtop, all with shroud vent. (2360-40)..... **\$160.00 ea.**
- *1338353** Left side. Front hinge pillar lower front half. 1961 Lark all models. (2360-40)..... **\$40.00 ea.**
- *1352299** Left side. Hinge pillar inner panel. 66 Lark. (2360-40)..... **\$50.00 ea.**
- 1352294** Right cowl panel. 1963-66 Lark. (2360-40)..... **\$200.00 ea.**

C-CAB TRUCK



- #651898** No illustration. Reinforcement, hinge pillar to windshield side opening..... **\$60.00 ea.**
- 653022** Right front, fender apron. All 1949-64 C-Cab. No illustration **\$75.00 ea.**
- 801240** 48" Tailgate. 1949-55 truck. (2458-11) **\$570.00 ea.**
- 801366** 51" Tailgate. 1956-59. (2458-11)..... **\$600.00 ea.**

653495 Cowl top and roof panel. ... **\$300.00 ea.**

801256 Truck bed header panel. 1949-55 C-cab..... **\$225.00 ea.**

- #652384** Right rear, outside panel. 6.5 foot Truck: C-Cab 2R-5E **\$95.00 ea.**
- #652385** Left rear, outside panel. 6.5 foot. Truck: C-Cab 2R-5E. (2458-8)..... **\$95.00 ea.**
- 652534** Right rear, outside panel. 8 foot P1 box. Truck: 2R-5E. (2458-8) **\$95.00 ea.**
- #652535** Left rear, outside panel. 8 foot P1 box 2-5E (2458-8) **\$95.00 ea.**
- #1654013** Left rear outer bed side panel. 9 foot. Truck: C-Cab 2E-5E **\$95.00 ea.**
- #652530** Right front, outer bedside panel. 8 foot P1 box (2458-6)..... **\$75.00 ea.**
- #652531** Left front, bed outside panel. 8 foot P1 box (2458-6)..... **\$75.00 ea.**
- #1654009** Left front outer bed side panel. 9 foot. Truck: C-Cab 2E-5E **\$95.00 ea.**
- 1655988-9** Right & Left running boards. 1962-64 C-Cab models 13 thru 45. Part of AC-3267 running board kit. (1506-1). **\$295.00 ea.**

1688124P Splash guard, grill to bumper C-Cab. 1957-64 except Scotsman..... **\$95.00 ea.**

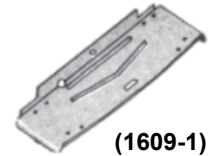

TAILGATE RELATED PARTS

- 652476** Tailgate pivot or hinge. All 1949-59 Trucks & 1960-62 with P-1 bed..... **\$18.00 ea.**
- 652111** Tailgate chain only for trucks with P1 Bed **\$32.00 ea.**
- 652112** Chain cover only for Trucks with P1 Bed. **\$22.00 ea.**
- 652796** Chain and Cover for trucks with P1 Bed. **\$49.00 ea.**
- 1656119** Tailgate chain. All Studebaker Trucks for trucks with P-2 bed. NOS (2158-25) **\$16.00 ea.**
- 1656120** Chain cover only for trucks with P2 Bed **\$22.00 ea.**
- 1656121** Chain and Cover for trucks with P2 Bed **\$22.00 ea.**

M-SERIES TRUCK

801255 Truck bed header panel. 1941-48 M-Series **\$315.00 ea.**

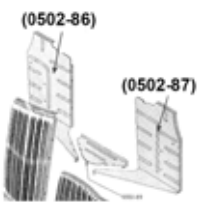

(2416-21)..... **\$250.00 ea.**

#648720 Right hood side panel. 1941-48 Truck: M5-17. **\$75.00 ea.**



#648721 Left hood side panel. 194-48 Truck: M-5-17. (1621-2)..... **\$75.00 ea.**

#648723 Left extension, front fender to hood side extension panel. 1941-48 Truck: M5-M17. Used. (1601-14)..... **\$75.00 ea.**

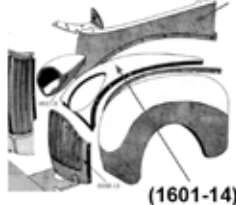

801239 Tailgate. 1941-48 M-series (2458-11) **\$550.00 ea.**

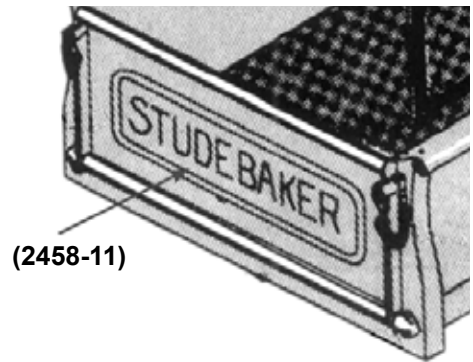

648805 Tailgate pivot or hinge. All 1941-48 M-series Truck..... **\$18.00 ea.**

8E POSTAL ZIP VAN

#1657016 Panel, rear & floor step well. (2160-257) **\$60.00 ea.**

#1657598 Pocket door panel, step well (2160-263) **\$32.00 ea.**

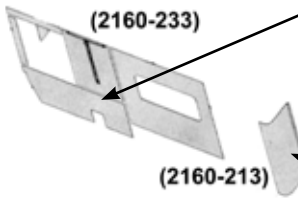

#1657157 Left, front lower, interior panel. (2160-233) **\$70.00 ea.**

#1657233 Left, rear corner, interior panel. (2160-213) **\$97.00 ea.**

#1657223 Left, front, wheel housing. (2160-240) .. **\$105.00 ea.**

#1657260 Grille. (0502-11). Not illustrated **\$120.00 ea.**

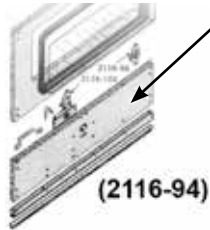

#1657800 Lower rear door panel . (2116-94) ... **\$75.00 ea.**

#1657850 Support, gas tank assembly. (1507-33)..... **\$95.00 ea.**

#1657851 Front, step well channel. (1507-27) **\$100.00 ea.**

#1657852 Center, step well channel (1507-28). **\$40.00 ea.**

#1657853 Rear, step well channel (1507-29) **\$40.00 ea.**

#1657854 Right rear corner plate and channel assembly (1507-36) **\$40.00 ea.**

#1657855 Left rear corner plate and channel assembly (1507-37)..... **\$40.00 ea.**

#1657856 Bracket, rear bumper & step channel. (1507-42) **\$94.00 ea.**

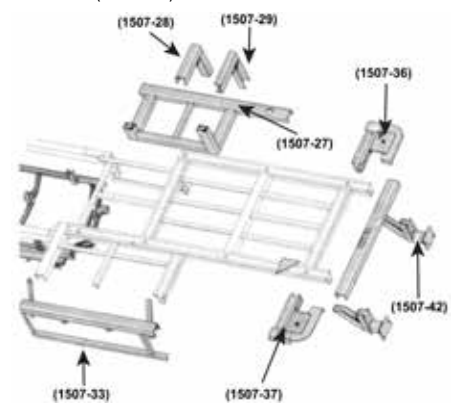

1960-64 T-CAB TRUCK

#1331762P Right, front air deflector panel 1960-64. (1601-2-3) **\$90.00 ea.**

#1331763P Left, front air deflector panel 1960-64. (1601-2-3) **\$120.00 ea.**



#1655301 Shield, pedal protector. Truck: 1960-62. (2138-10)..... **\$75.00 ea.**

#1655242 Right, rocker panel. Truck: all 1960-64. (2160-126)..... **\$75.00 ea.**

#1655243 Left, rocker panel. Truck: all 1960-64. (2160-126) **\$75.00 ea.**

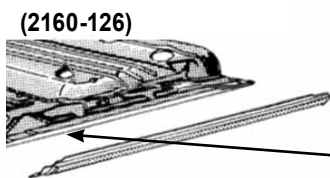

#1655217 Roof panel. Truck: all 1960-64. (2160-1)..... **\$300.00 ea.**

#1655749 Dash panel. Truck: all 1961-62. (2160-37) **\$350.00 ea.**

(2160-37)

(0617-73)

Light assemblies sold separately on page 193.

#1655364 Floor panel. Truck: 1960-62 with 3-speed transmission. In excellent condition **\$900.00 ea.**

#1655673 Left, front fender apron. Truck: 1961-62 Pickup..... **\$100.00 ea.**

#1655681 Grille or nose panel. Truck: all 1960-64. (0617-73)..... **\$400.00 ea.**

Note: 1331752 featured in the car section is the same piece except for the rubber splash shield.

Note: 1331753 featured in the car section is the same piece except for the rubber splash shield.

(1601-2-2)

#1655673 Left, front fender apron. Truck: 1961-62 pickup..... **\$100.00 ea.**

#1656326 Right, front fender apron. Truck: 1963-64. (1601-2-2)..... **\$100.00 ea.**

#1656327 Left, front fender apron. Truck: 1963-64. (1601-2-2) **\$100.00 ea.**

#1656328 Right, front fender apron. Truck: 1963-64 with right hand drive. (1601-2-2) **\$100.00 ea.**

1961-64 P-2 PICKUP BED PARTS —Type with smooth sides & no outer fenders—

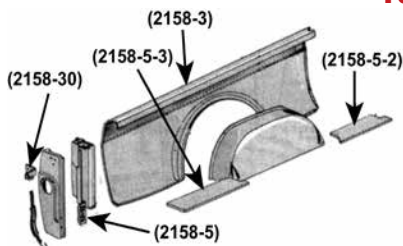

#1655025 Left side panel. P2 box. 6.5 foot bed (2158-3)..... **\$600.00 ea.**

#1656004 Right floor panel. 6.5 foot bed. Located in front of wheel housing (2158-5-2) **\$45.00 ea.**

#1656005 Left front floor panel. 6.5 foot bed. Located in front of wheel housing (2158-5-2) **\$45.00 ea.**

#1656011 Left floor panel. 6.5 foot bed. Located behind wheel housing. (2158-5-3)..... **\$65.00 ea.**

#1656012 Right floor panel. 8 foot bed. Located behind wheel housing (2158-5-3)..... **\$65.00 ea.**

#1656019 Rear lower panel. Beneath tailgate. (2158-10)..... **\$95.00 ea.**

#1656026 Right outside panel. 8 foot bed (2158-3) **\$650.00 ea.**

#1656027 Left outside panel. 8 foot bed (2158-3) **\$650.00 ea.**

#1656068 Floor panel. 6.5 feet **\$350.00 ea.**

#1656087 Left outer corner panel. Part with tail light lens hole. (2158-30) **\$125.00 ea.**

#1656088 Right rear corner reinforcement (2158-5). **\$30.00 ea.**

#652796 Chain and Cover for trucks with P1 Bed **\$49.00 ea.**

#1656119 Tailgate chain with covers for trucks with P-2 bed **\$16.00 ea.**

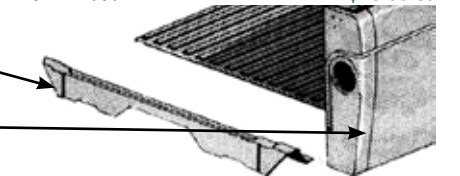

#1656120 Rubber chain covers for trucks with P-2 bed **\$22.00 ea.**

#1656121 Chain and Cover for trucks with P2 Bed **\$22.00 ea.**



Dan Ripple's 1955 E7 Truck from High Point, North Carolina



ENGINE SECTION GLOSSARY

Engine Identification Charts for

1939-54 Champion or Commander.....	144
1955-64 Car.....	145
Trucks: 1941-56.....	146
Trucks: 1957-63.....	147
Cylinder Heads & Gaskets.....	148
Motor Mounts & Kits.....	148-149

I finally found the part I was searching for at Studebaker International!

Now I know to call them first!

317-462-3124

*The following charts are designed to help you identify the type of engine in your car.
At the top of each chart is "where to look" directions to help you locate the serial & engine numbers.
If you're unsure what year or model your car is, then use the starting engine numbers listed below.*

1939-42 & 1946 CHAMPION

Car Serial Number Plate: **1939 CHAMPION:** Under the front fender, left side of frame
1940 CHAMPION: Either on the left front door hinge pillar or under the front fender, left side of frame
1941-42 CHAMPION: Left front door hinge pillar

Engine Number: **1939-42 Champion:** Top left side, front corner of the cylinder block

YEAR & MODEL	STARTING ENGINE NUMBER	YEAR & MODEL	STARTING ENGINE NUMBER
1939 Champion	101	1942 Champion	186,301
1940 Champion	34,101	1946 Champion	216,501
1941 Champion	101,201		

Note: A "C" anywhere in your engine number indicates your car was built in Canada.

1947-50 CHAMPION & COMMANDER

Car Serial Number Plate: Left, front door lock pillar post

Engine Number: Stamped on a boss at the top, left side, front corner of the cylinder block

YEAR & MODEL	STARTING ENGINE NUMBER	YEAR & MODEL	STARTING ENGINE NUMBER
1947 Champion	236,001	1947 Commander	H-182,001
1948 Champion	342,001, C-1,101	1948 Commander	H-238,001
1949 Champion	441,001, C-4,101	1949 Commander	H-326,001
1950 Champion	521,001, C-10,501	1950 Commander	H-370,001

Note: A "C" anywhere in your engine number indicates your car was built in Canada.

1951-54 CHAMPION & COMMANDER

Car Serial Number Plate: **1951-52 SERIES:** Left, front door lock pillar post
1953-54 SERIES: Left, front door hinge pillar

Engine Number: **CHAMPION:** Stamped on a boss at the top left side, front corner of the cylinder block
1951-52 COMMANDER: Stamped on a boss at the top side, rear end of cylinder block next to the distributor
1953-54 COMMANDER: Stamped on a boss at the top side, front end of cylinder block next to the fuel pump support

YEAR & MODEL	STARTING ENGINE NUMBER	YEAR & MODEL	STARTING ENGINE NUMBER
1951 Champion	778,001, C-25,501	1951 Commander	V-101, VC-101
1952 Champion	911,501, C-36, 722	1952 Commander	V-123,001, VC-2,036
1953 Champion	1,004,001, C-46,501	1953 Commander	V-207,001, VC-3,501
1954 Champion	1,090,001, C-55,782	1954 Commander	V-282,501, *VC-4,941

1955-58 CHAMPION, COMMANDER & PRESIDENT 1957-58 GOLDEN HAWK, PACKARD & CLIPPER

Car Serial Number Plate: Left front door hinge

Engine Number: **CHAMPION:** Stamped on a boss at the top, front end of cylinder block, next to the oil filler tube
COMMANDER: Stamped on a boss at the top, front end of cylinder block, next to the oil filler tube
PRESIDENT: Stamped on a boss at the top, front end of cylinder block, next to the oil filler tube
GOLDEN HAWK: Stamped on a boss at the top, front end of cylinder block, next to the oil filler tube
PACKARD: Stamped on a boss at the top, front end of cylinder block, next to the oil filler tube

YEAR & MODEL	STARTING ENGINE NUMBER	YEAR & MODEL	STARTING ENGINE NUMBER
1955 Champion	1,138,001, L-101, C-60,501	1957 Commander	V-390,001 VC-10,701
1955 Commander	V-312,701, V-331,101, VL-101, VC-5,701, VC-6,201	1957 Golden Hawk	PS-1,001
1955 President	P-101, PL-101, PC-101	1957 President	P-39,601, PC-1,501
1956 Champion	C-66,001, VC-8,101, 1,180,251, L-3,201	1958 Champion	1,228,401, C-74,701
1956 Commander	V-363,751 VL-6,301 VC8,101	1958 Commander	V-407,501, VC-13,301
1956 President	P-22,001 PL-2,701 PC-601	1958 Golden Hawk	PS-5,501
1957 Champion	1,202,101, C-71,401	1958 Packard	L-101
1957 Clipper	LS-101	1958 Packard Hawk	LS-5,201

1959-64 CAR EXCLUDING AVANTI

Car Serial Number Plate: Left front door hinge pillar

Engine Number: **SIXES:** Stamped on a boss at the top left side, front corner of the cylinder block
EIGHTS: Stamped on a boss at the top, front end of the cylinder block

ENGINE ID FOR 1964 MODELS

V	8-259 ENGINE	JT	JET THRUST
VC	8-259 ENGINE, CANADA	JTS	JET THRUST SUPERCHARGED
P	8-289 ENGINE	JTC	JET THRUST, CANADA
PC	8-289 ENGINE, CANADA	JTSC	JET THRUST SUPERCHARGED, CANADA
S	6-170 ENGINE	SC	6-170 ENGINE, CANADA
YEAR & MODEL	STARTING ENGINE NUMBER	YEAR & MODEL	STARTING ENGINE NUMBER
1959 6 Cylinder	S-10,001, SC-10,001	1959 8 Cylinder	V-418,701, VC-14,701
1960 6 Cylinder	S-106,001, SC-15,501	1960 8 Cylinder	V-454,701, P-70,501, VC-16,701, PC-2,201
1961 6 Cylinder	S-172,601, SC-20,101	1961 8 Cylinder	V-510,401, P-74,701, VC-18,501, PC-2,501
1962 6 Cylinder	S-210,901, SC-24,301	1962 8 Cylinder	V-534,901, P-79,801, VC-19,601, PC-2,801
1963 6 Cylinder	S-261,201, SC-29,701	1963 8 Cylinder	V-566,601, P-93,601, JT-1,001, JTS-1,001, VC-21,401, PC-3,401, JTC-1,001, JTSC-1,001
1964 6 Cylinder	SEE ENGINE ID	1964 8 Cylinder	SEE ENGINE ID

AVANTI 1963-64

Car Serial Number Plate: Right frame side rail in front of No. 1 body hold down bracket

Engine Number: Stamped on boss at top, front end of cylinder block, next to left front corner of lifter cover

AVANTI AFTER JULY 1963

YEAR & MODEL

STARTING ENGINE NUMBER

1963-64 Avanti R-1001, RS-1001
 R- 8-289 ENGINE WITH ONE 4BBL CARBURETOR • RS- 8-289 ENGINE WITH ONE 4BBL CARBURETOR, SUPERCHARGED

The following charts are designed to help you identify the type of engine in your car.

At the top of each chart is "where to look" directions to help you locate the serial & engine numbers.

If you're unsure what year or model your car is, then use the starting engine numbers listed below.

TRUCK 1941-48

Truck Serial Number Plate: On left side of the seat riser

Engine Number: Stamped on top, left side, front corner of the cylinder block

YEAR & MODEL	STARTING ENGINE NUMBER	YEAR & MODEL	STARTING ENGINE NUMBER
1941-48 M-5	1M-001	1946-48 M-15	2M-6401
1941-42 M-15	2M-001	1941-48 M-16	3M-001
1045 M-15	2M-2001	1946-48 M-17	3M-6101

TRUCK 1949-56

Truck Serial Number Plate: On left side of the seat riser

Engine Number: 6-CYLINDER: Top left side, front corner of the cylinder block V-8 - Top front end of cylinder block next to the oil filler

YEAR & MODEL	STARTING ENGINE NUMBER	YEAR & MODEL	STARTING ENGINE NUMBER
1949-53 2R 5 6-cylinder	1R-001, H1R-001	1955 E 6 6-cylinder	4E-101
1949-53 2R 6 6-cylinder	6R-101	1955 E 7 V-8	2E-101
1949-53 2R 10 6-cylinder	1R-001	1955 E 10 6-cylinder	1E-101
1949-53 2R 11 6-cylinder	6R-101	1955 E 11 6-cylinder	4E-101
1949-53 2R 14 6-cylinder	6R-101	1955 E 12 V-8	2E-101
1949-53 2R 15 6-cylinder	2R-001	1955 E 13 V-8	1E-101
1949-53 2R 16 6-cylinder	3R-001	1955 E 14 6-cylinder	4E-101
1949-53 2R 16A 6-cylinder	4R-101	1955 E 15 6-cylinder	2E-101
1949-53 2R 17 6-cylinder	3R-001	1955 E 16 6-cylinder	4E-101
1949-53 2R 17A 6-cylinder	4R-001	1955 E 17 6-cylinder	4E-101
1954 3R 5 6-cylinder	1R-149,001, H1R-6,575	1955 E 28 V-8	3E-101
1954 3R 6 6-cylinder	6R-24,701	1955 E 38 V-8	5E-101
1954 3R 10 6-cylinder	1R-149,001	1956 2E 5 6-cylinder	1E-6,051, H1E-401
1954 3R 11 6-cylinder	6R-24,701	1956 2E 6 6-cylinder	4E-2,351
1954 3R 14 6-cylinder	6R-24,701	1956 2E 7 V-8	2E-7,001
1954 3R 15 6-cylinder	2R-14,201	1956 2E 10 6-cylinder	1E-6,051
1954 3R 16 6-cylinder	4R-59,001	1956 2E 11 6-cylinder	4E-2,351
1954 3R 17 6-cylinder	4R-59,001	1956 2E 12 V-8	2E-7,001
1954 3R 28 V-8	VT-2,301	1956 2E 13 V-8	3E-1,301
1954 3R 38 V-8	VT-2,301	1956 2E 14 6-cylinder	4E-2,351
1955 E 5 6-cylinder	1E-101, H1E-101	1956 2E 28 V-8	3E-1,301
		1956 2E 38 V-8	5E-3,501

***WHEN 259 HEAVY DUTY ENGINE IS INSTALLED IN THESE MODELS THE ENGINE WILL BE IDENTIFIED BY A 5E NUMBER.**

•WHEN 289 STANDARD ENGINE IS INSTALLED IN THESE MODELS THE ENGINE WILL BE IDENTIFIED BY A 7E NUMBER.

•WHEN 289 HEAVY DUTY ENGINE IS INSTALLED IN THESE MODELS THE ENGINE WILL BE IDENTIFIED BY A 6E NUMBER.

HEAVY DUTY ENGINES WILL BE FURTHER IDENTIFIED BY THE STENCILED CLOVER LEAF SYMBOL ON THE ENGINE NUMBER

TRUCK 1957-61 ————— **Truck Serial Number Plate:** On left side of the seat riser

Engine Number: 6-CYLINDER: Top left side, front corner of the cylinder block V-8 - Top, front end of cylinder block next to the oil filler

YEAR & MODEL	STARTING ENGINE NUMBER	YEAR & MODEL	STARTING ENGINE NUMBER
1957-58 3E 5 6-cylinder	1E-10,101	1959 4E 14, 14D 6-cylinder	4E-7,301
1957-58 3E 6, 6D 6-cylinder	4E-3,401	1959 4E 16 6-cylinder	4E-7,301
1957-58 3E 7, 7D V-8	3E-2,701*	1959 4E 28 V-8	3E-8,001*
1957-58 3E 10 6-cylinder	1E-10,101	1959 4E 40 V-8	6E-2,401*
1957-58 3E 11, 11D 6-cylinder	4E-3,401	1960 5E 5 6-cylinder	1E-18,301
1957-58 3E 12, 12D V-8	3E-2,701*	1960 5E 6 6-cylinder	4E-9,401
1957-58 3E 13 V-8	3E-2,701*	1960 5E 7 V-8	3E-9,201*
1957-58 3E 14 6-cylinder	4E-3,401	1960 5E 11 6-cylinder	4E-9,401
1957-58 3E 16 6-cylinder	4E-3,401	1960 5E 12 V-8	3E-9,201*
1957-58 3E 17 6-cylinder	4E-3,401	1960 5E 13, 13D V-8	3E-9,201*
1957-58 3E 28 V-8	3E-2,701*	1960 5E 14, 14D 6-cylinder	4E-9,401
1957-58 3E 38 V-8	5E-6,501*	1960 5E 16 6-cylinder	4E-9,401
1957-58 3E 40 V-8	6E-101	1960 5E 28 V-8	3E-9,201*
1959 4E 1 6-cylinder	1E-15,001	1960 5E 40 V-8	6E-3,901
1959 4E 2, 2D V-8	3E-8,001*	1961 6E 5 6-cylinder	1E-20,601
1959 4E 3, 3D 6-cylinder	4E-7,301	1961 6E 7 V-8	3E-11,601*
1959 4E 5 6-cylinder	1E-15,001	1961 6E 10 6-cylinder	1E-20,601
1959 4E 6, 6D 6-cylinder	4E-7,301	1961 6E 12 V-8	3E-11,601*
1959 4E 7, 7D V-8	3E-8,001*	1961 6E 13, 13D V-8	3E-11,601*
1959 4E 11, 11D 6-cylinder	4E-7,301	1961 6E 28 V-8	3E-11,601*
1959 4E 12, 12D V-8	3E-8,001*	1961 6E 40 V-8	6E-4,601*
1959 4E 13, 13D V-8	3E-8,001*		

TRUCK 1962-63 ————— **Truck Serial Number Plate:** On left side of the seat riser

Engine Number: 6-CYLINDER: Top left side, front corner of the cylinder block V-8 - Top, front end of cylinder block next to the oil filler

YEAR & MODEL	STARTING ENGINE NUMBER	YEAR & MODEL	STARTING ENGINE NUMBER
1962 7E 5 6-cylinder	1E-23,901	1963 8E 7 V-8	3E-18,901*
1962 7E 7 V-8	3E-14,801*	1963 8E 10 6-cylinder	1E-27,801
1962 7E 10 6-cylinder	1E-23,901	1963 8E 12 V-8	3E-18,901*
1962 7E 12 V-8	3E-14,801*	1963 8E 13, 13D V-8	3E-18,901*
1962 7E 13, 13D V-8	3E-14,801*	1963 8E 15 3-cylinder	3D-4,000
1962 7E 28A V-8	3E-14,801*	1963 8E 25 3-cylinder	3D-4,000
1962 7E 28C V-8	3E-14,801*	1963 8E 28A V-8	3E-18,901*
1962 7E 35A 4-cylinder	4D-4,000	1963 8E 28C V-8	3E-18,901*
1962 7E 35C 4-cylinder	4D-4,000	1963 8E 35A 4-cylinder	4D-5,000
1962 7E 40A V-8	6E-5,101*	1963 8E 35C 4-cylinderr	4D-5,000
1962 7E 40E V-8	6E-5,101*	1963 8E 40A V-8	6E-5,501*
1962 7E 45A 4-cylinder	4D-4,000	1963 8E 40E V-8	6E-5,501*
1962 7E 45E 4-cylinder	4D-4,000	1963 8E 45A 4-cylinder	4D-5,000
1963 8E 5 6-cylinder	1E-27,801	1963 8E 45E 4-cylinder	4D-5,000

Exceptions to note on previous page - *Standard engines will be identified by a 3E (259) or 7E (289) engine number. Heavy duty engines will be identified by a 5E (259) or 6E (289) engine number.

CYLINDER HEADS

6-Cylinder

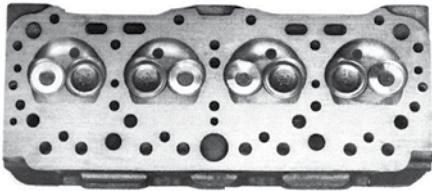

- 1544289** 1958 185 cubic inch 6-cylinder. 7.5:1 compression ratio**\$85.00 ea.**
- 1544290** Low compression. 1958 185 cubic inch 6-cylinder**\$93.50 ea.**
- 1548294** Low compression. 1959-60 170 cubic inch 6-cylinder.**\$85.00 ea.**
- 1549218** 1959-60 170 cubic inch 6-cylinder**\$85.00 ea.**
- 1565707** Late 1966 194 cubic inch 6-cylinder...
.....**\$250.00 ea.**
- 1692061** 1938-60 Commander 6-cylinder. 7.5:1 compression ratio**\$115.50 ea.**
- 1692062** 1938-60 Commander 6-cylinder. 7.0:1 compression**\$105.00 ea.**

MOTOR MOUNTS

-  **180437** Front upper. 1939-46, 1951-52 Champion. 1941-42 & 1951-52 Commander. Truck: M5 & M15, 2R, 3R, E-8E. All rear lower. 1937-38 Commander. 1937-38 Coupe Express. Truck: Rear upper. M16-M17 & 2R-8E al.....**\$10.00 ea.**
-  **191088** Front. Commander & Dictator: 1936-50 President: 1936-42**\$60.00 ea.**
-  **195801** Rear upper. 1937-40 Commander, 1937-39 Coupe Express & 1937-40 President**\$16.50 ea.**
-  **196717** Front. 1947-50 Champion. Rear. 1941-42 Commander, 1939-46 Champion & M5-M15 truck**\$33.15 ea.**
- 519917** Spacer rear engine support 1947-49 Champion**\$4.25 ea.**
-  **520264** Rear upper. 1947-50 Champion**\$38.00 ea.**
-  **520265** Rear lower. 1947-49 Champion**\$20.00 ea.**
-  **520987** Rear upper. 1947-50 Commander. Front upper. 1951-52 Commander**\$9.50 ea.**
-  **520988** Rear lower. 1947-49 Commander**\$7.50 ea.**
-  **526308** Rear lower. 1950 Champion**\$26.00 ea.**

CYLINDER HEAD GASKETS



- 167033** 1929-32 Dictator, 1929-33 Commander 8 & 1933 President 8 model 82**\$65.00 ea.**
- 178200** 1933 President 8 model 33**\$65.00 ea.**
- 184442** 1934-37, 8 cylinder with cast iron head.**\$65.00 ea.**
- 184651** 1935 Dictator 6-cylinder with cast iron head**\$45.00 ea.**
- 191829** 1938-42 President 8**\$65.00 ea.**
- 527057** 1938-60 Commander 6-cyl.**\$108.00 ea.**
- 529321** 1951-54 V-8**\$20.75 ea.**
- 534598** 1939-60 Champion 6-cyl. ..**\$108.00 ea.**
- 535982** 1955-64 V-8 & 1963-64 Avanti (thick)...
.....**\$40.00 ea.**
- 1545072** 1955-64 V-8 & 1963-64 Avanti (thin)..
.....**\$31.50 ea.**
- 1564448** 1965-66 V-8**\$11.00 ea.**
- 1564876** 1965 6-cylinder**\$10.00 ea.**
- 1565709** 1966 6-cylinder**\$10.00 ea.**
- 1558948** 1961-64 6-cyl.**\$45.00 ea.**

-  **526310** Rear lower. 1950 Commander**\$16.50 ea.**
-  **526471** Rear, auto. transmission. 1950-52 car & early E-2E 7, 12 truck**\$75.00 pr.**
-  **532425** Rear. 1953-55 car, all models with auto. transmission**\$75.00 pr.**
-  **530276** Front lower. 1951-52 V-8
.....**\$14.00 ea.**
-  **532258** Rear motor mount. 1953-55 car all, 1956-58 car 6-cyl., 1959-64 car 6 cyl. C & K, 1960-64 conv. 6 cyl.
.....**\$68.00 ea.**
-  **533296** Front. 1953-64 V-8, all models including Avanti
.....**\$16.80 ea.**
- 535743** Front 1955-58 Champion sedans & Hawks; 1959-60 6-cyl Hawks**\$35.00 ea.**
-  **674993** Front lower. 1939-46 & 1951-52 Champion & 1941-42 Commander. Truck: 6-cylinder. M5-M17 & 2R-2E, 3R 28, 38 & 3E-5E 3, 6, 11, 14, 16, 17 & 3E-8E 1, 5, 10**\$15.00 ea.**
-  **674994** Truck: M16, M17, 2R-3R, 16, 17. E-8E, 7,12, 13, 28, 38, 40. Lower front (V-8 only) and lower rear**\$18.00 ea.**

CYLINDER HEADS

V-8

- 527222** 1951-54 V-8, 7.0:1 compression ratio....
.....**\$95.00 ea.**
- 535298** 1951-54 V-8, 7.5:1 compression ratio....
.....**\$95.00 ea.**
- 536097** 1955-61 V-8, 7.5:1 compression ratio ...
.....**\$300.00 ea.**
- 1555295** 1962 V-8, 8.25:1 compression ratio. Only one**\$250.00 ea.**
- 1557571** 1963-64 standard V-8, 8.25:1 compression ratio. Also, 10.25:1 compression ratio when used on R-1 engines**\$300.00 ea.**
- 1564859** 1965-66 V-8, 7.5:1 compression ratio. Only one**\$250.00 ea.**
- 1564435** 1965-66 V-8, 9.25:1 compression ratio
.....**\$195.00 ea.**

DOWEL PIN

- 1554667** Dowel pin, cylinder head to block. 1951-64 V-8 all models & 1963-64 Avanti. Takes 4
.....**\$2.75 ea.**

-  **677282** Rear. Truck: 2R-2E 5, 10, 15. 3E-6E 1, 5, 10. 7E 5, 10
.....**\$31.45 ea.**
-  **800279** Rear. 1972-80 Avanti with auto trans. Takes 1
.....**\$14.00 ea.**
- 1564701** Rear. 1965-66 Lark. 1966-71 Avanti, all models with auto. transmission Takes 1
.....**\$12.80 ea.**
-  **800907** Front. 1963-64 Avanti R-3 & all V-8 models needing more engine & hood clearance
.....**\$18.20 ea.**
-  **1553609** 4 speed, rear 1961-64 Lark & Hawk, 1963-64 Avanti 3 speed & 4 speed. Use **1547196**
.....**\$73.00 ea.**
- 1547196** Rear. 1956-64 V-8 with standard trans
.....**\$73.00 ea.**
-  **1544970-1** Rear with auto. trans. 1958 all models. 1959-64 Hawk 1963-64 Avanti. Truck: 1956-64
.....**\$82.00 pr.**
- 1547202-3** Rear w/auto trans. 1956-57 Hawk. 1959-64 Lark. Truck: Late 2E-7 & 4E
.....**\$82.00 pr.**
-  **1556995** 1953-54 6-cylinder. front, & front & rear for all 1959-64 6-cyl. except Hawk & convertible
..... use **533296**
- 1564696** Front. 1965-66 6-cylinder**\$18.75 ea.**
-  **1564698** Front. 1965-66 V-8 Lark. 1966-83 Avanti. Takes 2...
.....**\$10.30 ea.**

MOTOR MOUNT KITS

1939-46 Champion 1941-42 Commander M5 & M15 Trucks

180437 (2).....	\$10.00 ea.
196717 (1).....	\$33.15 ea.
674993 (2).....	\$15.00 ea.
801577	
Kit price	\$108.00 ea.

1937-40 Dictator, Commander & President

180437 (2).....	\$10.00 ea.
191088 (1).....	\$60.00 ea.
195801 (2).....	\$16.50 ea.
801578	
Kit price	\$113.00 ea.

1947-49 Champion

196717 (1).....	\$33.15 ea.
520264 (2).....	\$37.50 ea.
520265 (2).....	\$20.00 ea.
801579	
Kit price	\$169.00 ea.

1950 Champion with standard trans.

196717 (1).....	\$33.15 ea.
520264 (2).....	\$37.50 ea.
526308 (2).....	\$26.00 ea.
801580	
Kit price	\$181.00 ea.

1947-49 Commander

191088 (1).....	\$60.00 ea.
520987 (2).....	\$9.50 ea.
520988 (2).....	\$7.50 ea.
801581	
Kit price	\$94.00 ea.

1950 Commander with standard trans.

191088 (1).....	\$60.00 ea.
520987 (2).....	\$9.50 ea.
526310 (2).....	\$16.50 ea.
801582	
Kit price	\$112.00 ea.

1950 Champion with automatic trans.

196717 (1).....	\$33.15 ea.
526471 (1pr).....	\$75.00 pr.
801583	
Kit price	\$133.00 ea.

1950 Commander

with automatic trans.

191088 (1).....	\$60.00 ea.
526471 (1pr).....	\$75.00 pr.
801584	
Kit price	\$135.00 ea.

1951-52 Champion

with standard trans.

180437 (2).....	\$10.00 ea.
532258 (1).....	No Stock
674993 (2).....	\$15.00 ea.
801585	
Kit price	\$50.00 ea.

1951-52 Champion

with automatic trans.

180437 (2).....	\$10.00 ea.
526471 (1pr).....	\$75.00 pr.
674993 (2).....	\$15.00 ea.
801586	
Kit price	\$125.00 ea.

1953-54 Champion

with automatic trans.

532425 & 526471.....	\$75.00 pr.
1556995 (2).....	use 533296
801589	
Kit price	\$108.00 ea.

1953-54 Commander

with automatic trans.

533296 (2).....	\$16.80 ea.
532425 & 526471.....	\$75.00 pr.
801590	
Kit price	\$108.00 ea.

1951-52 V-8

with standard trans.

520987 (2).....	\$9.50 ea.
530276 (2).....	\$14.00 ea.
532258 (1).....	No Stock
801591	
Kit price	\$47.00 ea.

1951-52 V-8

with automatic trans.

520987 (2).....	\$9.50 ea.
526471 (1pr).....	\$75.00 pr.
530276 (2).....	\$14.00 ea.
801592	
Kit price	\$122.00 ea.

1956-64 V-8

with standard trans.

1547196 (1).....	\$75.00 ea.
533296 (2).....	\$16.80 ea.
801927	
Kit price	\$108.00 ea.

1959-64 6-Cylinder

with standard trans except convertible

1556995 (4).....	use 533296
801596	
Kit price	\$66.00 ea.

1941-60 Commander 6-Cylinder Truck

with standard trans.

180437 (4).....	\$10.00 ea.
674993 (2).....	\$15.00 ea.
674994 (2).....	\$18.00 ea.
801598	
Kit price	\$106.00 ea.

1954-64 V-8 Trucks

with standard trans.

180437 (4).....	\$10.00 ea.
674994 (4).....	\$18.00 ea.
801599	
Kit price	\$112.00 ea.

Swap Meets

Unfortunately, we can only attend a select few.

Visit our online "Events" page for current met information and order deadlines.

Remember - delivery of your prepaid order during a meet is FREE!

www.studebaker-intl.com

FLY WHEEL WITH GEAR

1564409 1965-66 with standard and overdrive transmission. 6-cyl. w/heavy duty clutch & all V-8. \$150.00 ea.

1685602 Truck: 3E-7E 1, 5, 10 \$175.00 ea.

1687115 Truck: 3E-8E 7, 12, 13, 28, 38, 40, w/11" or 12" clutch & 259 V-8..... \$220.00 ea.

SHORT BLOCK GASKET & SEAL SETS

McKinnon Short Block Gasket & Seal Set

for all 1965-66 6-cylinder cars

Engine Gasket set includes:

- 1 Ea. **1564054**.....Timing cover seal
- 1 Ea. **1564055**.....Timing cover gasket
- 1 Ea. **1564061**..... Water pump
- 1 Ea. **1564080**...inlet/exhaust manifold
- 1 Ea. **1564092**.....Fuel pump
- 1 Ea. **1564419**.....Rear main oil
- 1 Ea. **1564044**.....Oil pump

1564864
Special Kit Price.\$5.00 ea.

McKinnon Short Block Gasket & Seal Set

for all 1965-66 V-8 cars

Engine Gasket set includes:

- 1 Ea. **1564054**.....Timing cover seal
- 1 Ea. **1564219**.....Timing cover gasket
- 1 Ea. **1564228**..... Water pump
- 1 Ea. **1564092**.....Fuel pump
- 1 Ea. **1564250** .Fuel pump mount plate
- 1 Ea. **1565168**.....Rear main oil

1564393
Special Kit Price.\$5.00 ea.

FAX: 317-462-8891

E-mail:
jim@studebaker-intl.com

What can I say?

I'm speechless. . .



I finally found the part I was searching for at Studebaker International!

Now, I know to call them first!

317-462-3124

INDIVIDUAL MCKINNON GASKETS & SEALS FOR ALL 1965-66 CARS

- 1563987** Valve stem. All..... **10¢ ea.**
- 1564026** Front oil pan. 1965-66 6-cylinder..... **\$1.00 ea.**
- 1564027** Rear oil pan. 1965-66 6-cylinder. **\$1.00 ea.**
- 1564044** Oil pump cover. 1965-66 6-cylinder. **50¢ ea.**
- 1564054** Timing cover. 1965-66 all..... **\$2.50 ea.**
- 1564055** Timing cover. 1965-66 6-cylinder. **\$1.50 ea.**
- 1564061** Water pump. 1965-66 6-cylinder..... **50¢ ea.**
- 1564064** Thermostat housing to engine. 1965-66 6-cylinder **50¢ ea.**
- 1564066** Water outlet. 1965-66 V-8 & 1966-85 Avanti. **\$1.50 ea.**
- 1564080** Inlet to exhaust manifold. 1965-66 6-cylinder. **\$1.50 ea.**
- 1564084** Inlet and exhaust manifold to head. 1965-66 6-cylinder. **\$3.00 ea.**
- 1564114** Distributor. 1965-66 6-cylinder..... **50¢ ea.**
- 1564187** Front oil pan. 1965-66 V-8.... **\$1.00 ea.**
- 1564188** Rear oil pan. 1965-66 V-8 **\$1.00 ea.**
- 1564215** Crankshaft to block. 1965-66 V-8..... **50¢ ea.**
- 1564219** Timing cover. 1965-66 V-8... **\$1.50 ea.**
- 1564226** Water pump plate. 1965-66 V-8..... **\$2.50 ea.**
- 1564228** Water pump. Takes 2. 1965-66 V-8..... **\$2.50 ea.**
- 1564250** Fuel pump mounting plate gasket. **\$1.50 ea.**
- 1564271** Distributor. 1965-66 V-8..... **50¢ ea.**
- 1564336** Oil pan plug. 1965-66 all..... **\$1.00 ea.**
- 1564419** Rear main oil. 1965-66 6-cylinder..... **\$4.00 ea.**
- 1564442** Cylinder head. 1965-66 6-cylinder..... **\$5.00 ea.**
- 1564448** Cylinder head. 1965-66 V-8..... **\$11.00 ea.**
- 1564876** 1965 6-cylinder..... **\$10.00 ea.**
- 1564879** Oil filter to body. 1965-66 V-8. **50¢ ea.**
- 1565168** Rear main oil. 1965-66 V-8 .. **\$5.00 ea.**
- 1565336** Rocker cover. 1965-66 6-cylinder..... **\$4.00 ea.**
- 1565709** Cylinder head. 1965-66 6-cylinder. **\$10.00 ea.**

The lucky ones, thankfully, on their way to a garage!





Dearl Peveler's 1953 Champion from Pahrump, Nevada

NOS CRANKSHAFTS

521525 1941-50 Champion 6-cylinder.....
.....\$650.00 ea.

530081 1951-54 V-8 232 cubic inch engine.....
.....\$550.00 ea.

1547105 1959-60 6-cylinder 170 cubic inch engine.....
.....\$550.00 ea.

1550774 1961 OHV 6-cylinder 170 cubic inch engine..
.....\$550.00 ea.

1552397 1955-58 185 6-cylinder.....
.....\$550.00 ea.

1556999 Late 1962-64 259 V-8..\$255.00 ea.

1558011 1955 - early 62 259 V-8...
.....\$220.00 ea.

1693393 Early 7E & 8E 6-cylinder truck with 10½" clutch and 1962 OHV 6-cylinder.....\$400.00 ea.

1697128 Late 8E 6-cylinder truck with 10½" clutch 1962 OHV 6-cylinder.....\$400.00 ea.



FRONT CRANKSHAFT TIMING COVER SEALS

167156 Front crankshaft washer seal. 1932-33 Rockne, 1931-34 Studebaker, 1934-42 Dictator, Commander, Coupe Express. 1929-33 Dictator & Commander 8, 1933 President 8 model 82, 1934-60 Commander 8 & President 8. 1951-64 V-8 & 1963-64 Avant.....\$7.05 ea.

186668 Cover gasket. 1936-60 Commander 6-cyl.....\$7.35 ea.

194219 Cork cover gasket. 1939-54 Champion 6-cylinder.....\$9.22 ea.

194484 Front plate gasket. 1939-54 Champion 6-cylinder.....\$11.90 ea.

197591 Front crankshaft seal. 1939-64 Champion 6-cylinder.....\$6.60 ea.

800393 Kit. 1955-64 Champion 6-cylinder. Includes: 1561172 cover gasket, 1561168 plate gasket & 197591 front crankshaft seal.....\$21.00/set

800394 Kit. 1955-64 V-8 & 1963-64 Avanti. Includes 1561166 cover gasket, 167156 front crankshaft washer seal, 527240 & 527856 water manifold gaskets. 537354 fuel pump gasket.....\$18.25/set

801107 Kit. 1939-54 Champion 6-cylinder. Includes: 194484 front plate gasket, 194219 timing cover gasket & 197591 front crankshaft seal.....\$22.25/set

801213 Kit. 1936-60 Commander 6-cylinder. Includes 186668 cover gasket, 523145 front plate gasket, 167156 front crankshaft washer seal.....\$15.75/set

1561166 Cover gasket. 1951-64 V-8.....\$6.75 ea.

1561172 Cover gasket. 1955-64 Champion 6-cylinder.....\$6.75 ea.

1564054 Timing cover oil. 1965-1966 V-8 & 65-66 6-cylinder.....\$2.50 ea.

1564055 Timing cover. 1965-1966 6-cylinder...\$1.50 ea.

1564219 Timing cover. 1965-66 V-8..\$1.50 ea.

CRANKSHAFT FRONT SEAL RETAINER

534542 Front seal retainer. 1951-64 V-8.....\$4.50 ea.



TIMING COVERS

191047 1938-50 Commander. Truck: 1938-5E with Commander 6.....\$47.00 ea.

518495 1947-55 Champion.....\$35.00 ea.

527121 1951-54 V-8.....\$38.40 ea.

534440 1955-64 6-cylinder. Truck: E-8E with Champion 6-cylinder.....\$34.00 ea.

1564052 1965-66 190 6-cylinder.....\$32.50 ea.

1564217 1965 V-8.....\$32.50 ea.

1565705 1966 230 6-cylinder.....\$39.00 ea.

1565706 1966 V-8.....\$42.00 ea.

CRANKSHAFT VIBRATION DAMPERS

186688 1934-60 car and truck with Commander 6-cylinder.....\$26.00 ea.

519387 1947-58 Champion. 1959-64 6-cylinder.....\$29.25 ea.

533128 Vibration damper. 1951-64 V-8 except Avanti. Used.....\$35.00 ea.

1558279 1963-64 Lark & Hawk, jet thrust engine.....\$229.95 ea.

1554247 1963-64 Avanti jet thrust engine. Pictured.....\$199.95 ea.



CRANKSHAFT VENTILATOR ASSEMBLY

for 1965-66 V-8 car

1564213.....\$10.00 ea.



SILICONE GASKET SEALER

800944 Forms a permanent non-hardening seal. 3 oz. tube.....\$8.50 ea.

CRANKSHAFT REINFORCER PLATE

186702 Front reinforcer plate. 1936-60 all with Commander 6-cylinder engine, 1942-64 all with Champion 6-cylinder engine, 1951-64 all with V-8 engine. Truck: early 1962.....\$7.25 ea.

CRANKSHAFT SHIMS

186693 .003 shim. 1936-60 Commander 6-cyl. & 1951-64 V-8.....\$3.00 ea.

186694 .005 shim. 1936-60 Commander 6-cylinder & 1951-64 V-8.....\$3.00 ea.

186695 .009 shim. 1936-60 Commander 6-cylinder & 1951-64 V-8.....\$3.00 ea.

537219 .003 shim. 1955-64 Champion 6-cyl.....\$2.25 ea.

537220 .005 shim. 1955-64 Champion 6-cylinder.....\$2.25 ea.

537221 .007 shim. 1955-64 Champion 6-cylinder.....\$2.25 ea.



Avanti.....\$12.50 pr.

CRANKSHAFT LOCK PLATE

182084 6-cylinder 1935-37 Dictator & 1938-1960 Commander. Limited supply.....\$12.00 ea.

515202 Lock plate. Keeps front crankshaft bolt from loosening. 1946-64 Champion 6-cyl. & V-8.....\$8.50 ea.



CAMSHAFTS



- 524882** 1947-60 Champion with 6-cylinder. (Pictured, above).....\$160.00 ea.
1549471 1961-64 OHV with 6-cylinder before SN312.....\$140.25 ea.

CAMSHAFT TIMING GEARS



- 532125X** Aluminum. 1939-54 Champion 6-cylinder.\$181.50 ea.

- 532128X** Aluminum. 1935-60 Commander 6-cylinder.\$181.50 ea.

- 1554447** 1955-64 6-cylinder. Substitute for 534717.\$75.00 ea.
1554448 1951-64 V-8 except HD truck & 1963-64 Avanti.....\$143.50 ea.
1564099 1965-66 6-cyl. NOS.....\$45.00 ea.
1685777 Aluminum. V-8 with Avanti jet thrust engine. Truck: many models with heavy duty equipment.....\$173.25 ea.

CONNECTING ROD BOLT

- 196567** 1939-64 Champion 6-cylinder.\$10.00 ea.

CRANKSHAFT PILOT BUSHING



- 194348** 1939-64 Champion 6-cylinder. Truck: M5, 15, 15A & 2R-2E 5, 10, 15 & 3E-6E 1, 5, 10 & 7E 5, 10. Fits in flywheel.....\$4.00 ea.
510168 1934-37 Dictator & 1937-39 Coupe Express & 1938-50 Commander & 1951-64 V-8 car & 1963-64 Avanti. Truck: M17 & 2R-6E all except 1, 5, 10, 15 & 7E-8E 5, 7, 10, 12, 13, 28.....\$3.50 ea.
1546522 1959-64 cars (Y1) with HD 10.5" clutch.....\$5.00 ea.
1563670 1965-66 all models.....\$27.80 ea.

REAR CRANKSHAFT BOLTS

- 194542** Bolt, to flywheel. Most models with standard trans.....\$3.95 ea.
526851 Bolt to flex plate. All models with automatic transmission. Takes 6.....\$4.50 ea.

FRONT CRANKSHAFT BOLTS



- 515111** 1942-64 various models. 2 1/16".\$24.00 ea.
537522 3". V-8 various models.\$29.90 ea.

- 908051** 11/16" diameter, 16" x 1 1/16".....\$29.50 ea.
1546041 2 7/16" 6-cylinder & V-8 various models & 1963-64 Avanti.....\$29.90 ea.
1550392 1 5/8". 1961-63 6-cylinder.\$29.50 ea.
1550393 11/16" diameter, 16" x 2 1/4".....\$29.50 ea.

Note: Various other lengths available, please inquire.

CAMSHAFT REAR HOLE PLUGS



- 194665** 1939-58 Champion. Truck: M5, 10, 15 & 2R-8E 1, 5, 10, 15. Steel. 1 3/4" shallow cup.....\$2.10 ea.
1539038 1951-early 62 V-8 car, all models. Truck: 2R-6E 7, 12, 13, 28, 38, 40. Brass. 1 1/2" disc.....\$3.00 ea.
1550434 1959-64 6-cylinder car, all models. Truck: 3E-8E 1, 5, 10. Steel. 1 3/4" shallow cup.....\$1.25 ea.
1550386 Late 1962-64 V-8 & 1963-64 Avanti. Truck: 7E-8E 7, 12, 13, 28, 38 (brass) 1 1/2" shallow cup.....\$3.50 ea.
1563963 1965 - 66 all. Steel. NOS.....\$1.00 ea.

PAL NUTS

For connecting rod bolts

- G107828** Pal nut V-8.....25¢ ea.
G441272 Pal nut 1939-64 Champion 6-cylinder.....70¢ ea.

CONNECTING RODS



* Due to a shortage of NOS rods, these rods require yours in exchange first.

- 517921** Odd # cylinders for 1939-64 Champion 6-cylinder with insert-type bearings. No exchange necessary.....\$54.00 ea.
517922 Even # cylinders for 1939-64 Champion 6-cylinder with insert-type bearings. No exchange necessary.....\$54.00 ea.
 Odd # cylinders for 1936-42 Dictator & Commander 6-cylinder with insert-type bearings with tapered piston pin clamp screw. Also all 1947-48 Commanders.
***517925** NOS - exchange.....\$65.00 Ex.
***517925X** Reconditioned - exchange.....\$45.00 Ex.
 Even # cylinders for 1936-42 Dictator & Commander 6-cylinder with insert-type bearings & with tapered piston pin clamp screw. Also all 1947-48 Commander.
***517926** NOS - exchange.....\$65.00 Ex.
***517926X** Reconditioned - exchanged.....\$45.00 Ex.
 Odd # cylinders for 1936-42 Dictator & Commander 6-cylinder with insert-type bearings. The type with hex head piston clamp screw.
***520145** NOS - exchange.....\$65.00 Ex.
***520145X** Reconditioned - exchange.....\$45.00 Ex.

CRANKSHAFT TIMING GEARS

- 183898** 1935-60 Commander 6-cylinder.\$103.25 ea.
194324 1939-54 Champion 6-cylinder.....\$83.00 ea.
527084 1951-64 V-8, all model car & truck including Avanti.....\$96.25 ea.

CAM BEARINGS



- 526223** All Commander 6-cylinder, 1932 Rockne, Dictator 6.....\$80.00/set
526224 1939-60 Champion 6-cylinder.....\$157.50/set
529459 1951-64 V-8 & 1963-64 Avanti.....\$126.00/set
1550620 1961-early 1962 6-cylinder without full-flow oil filter.....\$48.00/set
1556138 Late 1962-64 6-cylinder with full-flow oil filter.....\$51.00/set
1564386 Front & rear. 1965 - 66 6-cylinder. Takes 2. NOS.....\$3.00 ea.
1564387 Intermediate. 1965-66 6-cylinder. Takes 2 NOS.....\$3.00 ea.
1564521 Front. 1965-66 V-8. Takes 1. NOS.....\$3.00 ea.
1564522 Front intermediate & rear. 1965 - 66 V-8. Takes 2. NOS.....\$3.00 ea.
1564526 Center & rear. 1965 - 66 V-8. Takes 2. NOS.....No Stock

Even # cylinders for 1936-42 Dictator & Commander 6-cylinder with insert-type bearings. The type with hex head piston clamp screw.

- *520146** NOS - exchange.....\$65.00 Ex.

Odd # cylinders for 1949-60 Commander 6-cylinder engines.

- *523203** NOS - exchange.....\$78.00 Ex.

- *523203X** Reconditioned - exchange.....\$45.00 Ex.

Even # cylinders for 1949-60 Commander 6-cylinder engines. NOS.

- *523204** NOS - exchange.....\$78.00 Ex.

- *523204X** Reconditioned - exchange.....\$45.00 Ex.

Odd # cylinder, 1951-64 V-8.

- *527114** NOS - exchange.....\$75.00 Ex.

- *527114X** Reconditioned - exchange.....No stock

Even # cylinder, 1951-64 V-8.

- *527115** NOS - exchange.....\$65.00

- *527115X** Reconditioned - exchange.....\$55.00 Ex.

- 534303** 1955-64 Champion 6-cylinder.....\$85.00 ea.
1564094 1965 194 & 230 6-cylinder.....\$15.00 ea.
1565720 1966 194 & 230 6-cylinder.....\$15.00 ea.

ROD BEARING SETS

1939-64 CHAMPION 6-CYLINDER

520834 Standard.....	\$98.00/set
536188 -.002.....	\$98.00/set
520138 -.005.....	\$98.00/set
520836 -.010.....	\$118.35/set
520837 -.020.....	\$118.35/set
800322 -.030.....	\$120.25/set
800323 -.040.....	\$120.25/set
800324 -.060.....	\$120.25/set

1941-60 COMMANDER 6-CYLINDER

525593 Standard.....	\$129.45/set
525592 -.001.....	\$107.00/set
525594 -.005.....	\$89.00/set
525595 -.010.....	\$171.80/set
525596 -.020.....	\$171.80/set

1951-64 V-8 & 1963-64 AVANTI

1555395 Standard.....	\$145.50/set
530762 -.001.....	\$70.25/set
1555397 -.002.....	\$50.00/set
530763 -.005.....	\$70.00/set
1555398 -.010.....	\$178.50/set
1555399 -.020.....	\$178.50/set
800325 -.030.....	\$178.50/set



McKINNON CHEVROLET

1965-66 194, 230, 283 V-8 OR 6-CYLINDER

1564350 Standard.....	\$55.00/set
1564351 .001.....	\$40.00/set
1564352 .002.....	\$40.00/set
1564353 .010.....	\$55.00/set
1564354 .020.....	\$55.00/set

MAIN BEARING SETS

For Main Bearing Sizes Not Listed Please Call (317) 462-3124 and Inquire.

1939-54 CHAMPION 6-CYLINDER

517900 Standard.....	\$240.00/set
520827 -.001.....	\$99.00/set
517901 -.010.....	\$280.00/set
517902 -.020.....	\$270.00/set
517903 -.030.....	\$176.00/set
800784 -.040.....	\$176.00/set
800785 -.060.....	\$184.65/set

1936-48 COMMANDER 6-CYLINDER

517904 Standard.....	\$176.00/set
520828 -.001.....	\$145.00/set
517905 -.010.....	\$305.95/set
517906 -.020.....	\$331.50/set

1949-60 COMMANDER 6-CYLINDER

524142 Standard.....	\$280.50/set
524143 -.001.....	\$160.00/set
524144 -.010.....	\$255.00/set
524145 -.020.....	\$280.50/set

1955-64 CHAMPION 6-CYLINDER

1556295 Standard.....	\$176.00/set
1556296 -.001.....	\$99.95/set
1556297 -.002.....	\$99.95/set
1556298 -.010.....	\$280.00/set
1556299 -.020.....	\$218.75/set
1556300 -.030.....	\$218.75/set

1951-64 V-8 & 1963-64 AVANTI

1555404 Standard.....	\$176.75/set
1555407 -.010.....	\$176.75/set
1555408 -.020.....	\$176.75/set
1555409 -.030.....	\$192.50/set

McKINNON CHEVROLET

1965-66 194, 230, 6-CYLINDER Front & Center

1564420 Standard.....	\$35.00/set
1564421 .001.....	\$35.00/set
1564423 .010.....	\$35.00/set
1564424 .020.....	\$35.00/set

1965-66 194, 230, 6-CYLINDER Rear

1564454 Standard.....	\$45.00/set
1564455 .001.....	\$45.00/set
1564456 .002.....	\$45.00/set
1564457 .010.....	\$45.00/set
1564425 .020.....	\$45.00/set

1965-66 283 V-8 Rear Crankshaft

1564356 Standard.....	\$15.00/set
1564357 .001.....	\$15.00/set
1564358 .002.....	\$15.00/set
1564359 .010.....	\$15.00/set
1564360 .020.....	\$15.00/set

1965-66 283 V-8 Front & Center

1564374 Standard.....	\$15.00/set
1564375 .001.....	\$15.00/set
1564376 .002.....	\$15.00/set
1564377 .010.....	\$15.00/set
1564378 .020.....	\$15.00/set

REAR MAIN BEARING



SEALS

525945 Car: 1948 Commander. Truck: Late M16-17, early 2R16 - 2R17, all with 226 cubic inch engine..... **\$45.00 ea.**

1540603 1949-50 Commander. Truck: 1949-60 2R-5E 3, 6, 11,14, 16, 17 with Commander 6-cylinder engine..... **\$53.00 ea.**

1540604 1948-54 Champion 6-cyl.. **\$82.60 ea.**

1554698 1955-64 Champion 6-cyl.. **\$30.00/set**

1559366 1951-64 V-8 & 1963-64 Avanti..... **\$56.65/set**

24-Hour Shopping

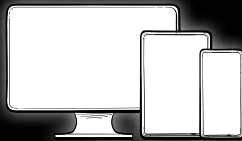

www.studebaker-intl.com

MCKINNON CHEVROLET MAIN BEARING CAPS



1564413 Main bearing cap, rear. 1965-66 6-cylinder..... **\$20.00 ea.**

1564446 Main bearing cap, front & center. 1965-66 all..... **\$20.00 ea.**

1564855 Main bearing cap, rear. 1965-66 V-8..... **\$20.00 ea.**

PISTON PINCH BOLTS

197299 6-cylinder, 1938-50 Commander 1938-42 use two types, (check before ordering) and 1939-64 6-cylinder Champion..... **\$10.50 ea.**

529348 1951-64 V-8 & 1963-64 Avanti..... **\$6.25 ea.**

PISTON SETS



1939-58 CHAMPION 6-CYLINDER

524316 Standard.....	\$560.00/set 6
534946 +.010.....	\$280.00/set 6
524296 +.020.....	\$560.00/set 6
534949 +.030.....	\$560.00/set 6
522112 +.040.....	\$560.00/set 6
800318 +.060.....	\$560.00/set 6

1947-60 COMMANDER 6-CYLINDER

524315 +Standard.....	\$699.00/set 6
524311 +.020.....	\$537.60/set 6
524312 +.030.....	\$537.60/set 6
522119 +.040.....	\$699.00/set 6
800320 +.060.....	\$699.00/set 6

1959-63 CHAMPION 6-CYLINDER

1547116 Standard.....	\$640.00/set 6
1547560 +.020.....	\$576.00/set 6
1547561 +.030.....	\$640.00/set 6
1547562 +.040.....	\$640.00/set 6
800319 +.060.....	\$640.00/set 6

1955-64 259 V-8

1539556 Standard.....	\$501.95/set 8
1553159 +.001.....	\$285.00/set 8
1553160 +.002.....	\$285.00/set 8
1553565 +.010.....	\$285.00/set 8
1539567 +.030.....	\$315.00/set 8
1539568 +.040.....	\$315.00/set 8
800321 +.060.....	\$295.00/set 8

1956-64 289 V-8

1558978 +.020.....	\$295.00/set 8
1558979 +.030.....	\$295.00/set 8
1558980 +.040.....	\$295.00/set 8
800315 +.060.....	\$295.00/set 8
801553 +.080.....	\$295.00/set 8

1963-64 289 AVANTI JET THRUST R-1 OR R-2

1557856 +.010.....	\$285.00/set 8
1557857 +.020.....	\$285.00/set 8
1557858 +.030.....	\$285.00/set 8
1557859 +.040.....	\$285.00/set 8
800280 +.060.....	\$285.00/set 8
801554 +.080.....	\$285.00/set 8

McKINNON CHEVROLET 1965-66 194 6-CYL.

Original type	
1564474 Standard.....	\$100.00/set
1564480 .020.....	\$100.00/set
1564482 .030.....	\$100.00/set
1564484 .040.....	\$100.00/set

1965-66 194 6-CYL. High Limits

1564476 Standard.....	\$100.00/set
------------------------------	--------------

McKINNON CHEVROLET PISTON RING SETS

1965-66 283 V-8 Production Type

564371 Standard.....	\$35.00/set
1564372 .020.....	\$35.00/set
1564373 .030.....	\$35.00/set

1965-66 283 V-8 High Mileage

1564381 Standard.....	\$35.00/set
1564382 .020.....	\$35.00/set
1564383 .030.....	\$35.00/set
1564384 .040.....	\$35.00/set

1965-66 283 V-8 Perfect Circle

1565042 Standard.....	\$35.00/set
1565043 .020.....	\$35.00/set
1565044 .030.....	\$35.00/set

1965-66 194 6-CYL. Sealed Power

1565073 Standard.....	\$35.00/set
1565074 .020.....	\$35.00/set
1565075 .030.....	\$35.00/set
1565076 .040.....	\$35.00/set

1965-66 283 V-8 Sealed Power

1565099 Standard.....	\$35.00/set
1565100 .020.....	\$35.00/set
1565101 .030.....	\$35.00/set
1565102 .040.....	\$35.00/set

1965-66 230 6-CYL. Sealed Power - High Mileage

1565757 Standard.....	\$35.00/set
1565760 .040.....	\$35.00/set

1965-66 194 6-CYL. Original Type

1564416 Standard.....	\$45.00/set
1564417 .020.....	\$45.00/set
1564418 .030.....	\$45.00/set

1965-66 194 6-CYL. High Mileage

1564415 Standard.....	\$45.00/set
1564414 .020.....	\$45.00/set
1564452 .040.....	\$45.00/set

PISTON RING SETS

1934-37 COMMANDER 6-CYL. Cast Iron

518108 Standard.....	\$125.00/set
518110 +.030.....	\$125.00/set

LATE 1939-60 COMMANDER 6 CYL. (Chrome)

1539639 Standard.....	\$101.70/set
1539640 +.020.....	\$101.70/set

1939-63 CHAMPION 6-CYL. Cast Iron

518102 Standard.....	\$92.00/set
518103 +.020.....	\$92.00/set
518104 +.030.....	\$92.00/set
522695 +.040.....	\$92.00/set
800329 +.060.....	\$92.00/set

1939-63 CHAMPION 6-CYL. Chrome

527037 +.040.....	\$107.00/set
--------------------------	--------------

1964 6-CYL. Cast Iron

1561352 Standard.....	\$92.00/set
1561354 +.020.....	\$84.00/set
1561355 +.030.....	\$84.00/set
1561356 +.040.....	\$84.00/set

1964 6-CYL. Chrome

1561357 Standard.....	\$107.00/set
------------------------------	--------------

1938-EARLY 1939 COMMANDER 6-CYL. (Cast Iron)

518111 std.....	\$125.00/set
518112 +.020.....	\$125.00/set
518113 +.030.....	\$125.00/set

LATE 1939-60 COMMANDER 6-CYL. Cast Iron

518114 Standard.....	\$84.75/set
518115 +.020.....	\$84.75/set
518116 +.030.....	\$84.75/set
522702 +.040.....	\$84.75/set
800330 +.060.....	\$84.75/set

1951-54 232, V-8 Cast Iron

530975 Standard.....	\$134.00/set
530976 +.020.....	\$134.00/set
530977 +.030.....	\$134.00/set
530978 +.040.....	\$149.00/set
800777 +.060.....	\$149.00/set

1951-54 232, V8 (Chrome)

531664 Standard.....	\$151.25/set
531665 +.020.....	\$151.25/set
531666 +.030.....	\$151.25/set
531667 +.040.....	\$151.25/set

1955-64 (Including Avanti)

224, 259 & 289 V-8 Cast Iron

536252 Standard.....	\$81.40/set
536253 +.020.....	\$81.40/set
536254 +.030.....	\$81.40/set
536255 +.040.....	\$81.40/set
800223 +.060.....	\$81.40/set
802295 +.080.....	\$81.40/set

1955-64 (Including Avanti)

224, 259 & 289 V-8 Chrome

801365 Standard.....	\$85.50/set
800957 +.020.....	\$85.50/set
800958 +.030.....	\$85.50/set
800959 +.040.....	\$85.50/set
800960 +.060.....	\$85.50/set
802110 +.080.....	\$85.50/set

NOTE: Chrome rings are also available for 6-cylinder and early V-8. Please inquire!

OIL PUMP TO BODY GASKETS

172622 Oil pump body cover gasket. 1934-49 Commander. Truck: 1934-49 with Commander 6-cyl. engine..... **\$2.00 ea.**

195304 Oil pump body gasket. 1939-60 Champion 6-cyl..... **\$2.00 ea.**

510193 Oil pump body gasket. 1934-50 Commander. Truck: 1934-60 with Commander 6-cyl. engine..... **\$2.00 ea.**

521371 Oil pump body cover gasket. 1939-60 Champion 6-cylinder..... **\$2.00 ea.**

526203 Oil pump body cover gasket. 1950 Commander. Truck: 1950-60 with Commander 6-cylinder engine..... **\$2.00 ea.**

527224 Oil pump gasket. 1951-64 V-8 & 1963-64 Avanti..... **\$1.39 ea.**

535697 Oil filler tube gasket. 1955-64 V-8 & 1963-64 Avanti..... **\$1.90 ea.**

543376 Oil pump body gasket. 1961-64 6-cylinder..... **\$2.00 ea.**

1555103 Oil filter base to block gasket. Late 1962-64 all models & 1963-64 Avanti..... **\$2.60 ea.**

1557705 Oil tube breather to pan gasket. 1963-64 Avanti jet thrust V-8..... **\$1.58 ea.**

1564861 Cover gasket, oil pump. 1965-66 V-8..... **\$1.00 ea.**

OIL PUMP STRAINERS

187333 1939 - early 1957 Champion 6-cylinder. 1936-42 All cars except President 1938-42 President. Does not include tube..... **\$75.00 ea.**

532968 1953-54 V-8..... **\$42.00 ea.**

535784 1955 V-8. Pictured..... **\$42.00 ea.**

1541778 Late 1957-64 Champion 6-cylinder. Includes tube..... **\$35.00 ea.**

1564204 1965-66 V-8..... **\$20.00 ea.**

1564870 1965-66 6-cylinder..... **\$20.00 ea.**

OIL ADDITIVE

801847 ZDDPlus avoid metal-to-metal wear on your engine. ZDDPlus After 70+ years of trouble-free, metal-to-metal engine protection, the EPA is forcing ZDDP (Zinc Dialkyl Dithio Phosphate +zinc and phosphorus) from domestic motor oils. If your engine was designed prior to the 1990's the non-roller lifters require the ZDDP in the motor oil to avoid premature deterioration! Don't let the lifters run metal-to-metal. Keep ZDDP, via ZDDPlus to every 4- to 5- quart oil change..... **\$12.31 ea.**

801847X10 Case of 10 ZDDP..... **\$110.00 ea.**

OIL PUMP REBUILD KITS & RELATED PARTS

517894 Oil pump & distributor drive gear. 11 teeth. 1947-60 Commander..... **\$40.00 ea.**

522072 Cover, oil pump kit. 1939-46 Champion, 1955-60 Champion. For pump with 1.5" tall gears..... **\$12.50 ea.**

800039 1956-64 V-8 car & truck & 1963-64 Avanti. Kit includes gears, shaft & cover plate. Pictured..... **\$157.25/set**

800743 1951-55 V-8. Kit includes gears & shaft..... **\$120.25 ea.**

800745 Major rebuild kit. 1939-60 Champion 6-cylinder. Includes both gears, 1/2" drive shaft with gear, thrust washer & gaskets..... **\$117.75 ea.**

801347 Major rebuild kit for 1948-60 Commander 6-cylinder. Includes 3 gears, thrust washer, key & gaskets..... **\$113.10 ea.**

801464 Rebuild kit. 1961-64 OHV 6-cylinder..... **\$101.75 ea.**

1539479 Cover, oil pump. 1956-64 V-8..... **\$15.00 ea.**

SPECIAL OIL PRESSURE RELIEF VALVE KIT

Kit includes:
 • 192136 valve
 • 536670 spring
 • 192125 washer



1939-64 Champion 6-cyl. 1951-64 V-8 car & truck & 1963-64 Avanti. Reg. price \$18.50 ea.

801172 Kit Price..... **\$16.60 ea.**

OIL PRESSURE RELIEF VALVES & SPRINGS

182075 Spring, 1934-60 Car & truck with Commander 6-cylinder..... **\$6.00 ea.**

182076 Valve. 1934-60 Commander 6-cyl..... **\$8.00 ea.**

192125 Washer. 1939-64 Champion 6-cyl. car & truck, 1951-64 V-8 & 1963-64 Avanti..... **\$1.70 ea.**

192136 Valve. 1939-64 Champion 6-cyl. car & truck, 1951-64 V-8 & 1963-64 Avanti..... **\$12.00 ea.**

G113897 Compression gasket. 1934-60 Commander 6-cylinder..... **\$1.50 ea.**



OIL PAN

525099 Oil pan. 1950 Champion..... **\$130.00 ea.**

1564863 Oil pan. 1965-66 Commander 6 V-8..... **\$85.00 ea.**

1565723 Oil pan. 1966 6-cylinder..... **\$75.00 ea.**

1691084 Truck: 4E -5E 3, 6, 11, 14, 16. Pictured, above..... **\$127.50 ea.**

Note: Others in stock - Please Inquire.

OIL DRAIN PLUGS



3080X2 1959-64 all models 6-cylinder & V-8 & 1963-64 Avanti. Includes gasket..... **\$4.10 ea.**

510080 1928-58 all models. Includes gasket..... **\$4.00 ea.**

801171 Oversized & self tapping. Replaces 510080 for 1928-58 all models. Includes gasket..... **\$5.50 ea.**

G113897 Gasket. 1932-33 Rockne, 1928-58 Studebaker..... **\$1.50 ea.**

1564336 Gasket. 1965-66 all..... **\$1.00 ea.**

OIL PAN GASKET SETS



S-346 1939-54 Champion 6-cylinder..... **\$16.45 ea.**

186710 1936-60 Commander 6-cylinder..... **\$26.00 ea.**

1561429 1955-64 Champion 6-cylinder..... **\$18.05 ea.**

1561465 1951-64 V-8 & 1963-64 Avanti..... **\$16.40 set**

MCKINNON CHEVROLET GASKETS & SEALS FOR ALL 1965-66 CARS

1564026 Front oil pan. 1965-66 6-cylinder..... **\$1.00 ea.**

1564027 Rear oil pan. 1965-66 6-cylinder..... **\$1.00 ea.**

1564187 Front oil pan. 1965-66 V-8..... **\$1.00 ea.**

1564188 Rear oil pan. 1965-66 V-8..... **\$1.00 ea.**

1564419 Rear main oil. 1965-66 6-cylinder..... **\$4.00 ea.**

1565168 Rear main oil. 1965-66 V-8..... **\$5.00 ea.**

OIL SLINGERS

Crankshaft



189316 Oil slinger. 1951-64 V-8 & 1963-64 Avanti..... **\$12.90 ea.**

197592 Oil slinger. 1939-64 with Champion 6-cylinder..... **\$4.25 ea.**

OIL BREATHER CAPS

177034 1935 Studebaker Six, 1934-42 Dictator, Commander 6 & 8's and Coupe Express, also President 8 through 1942..... **\$24.00 ea.**



1558194 Chrome oil breather cap with blue and white STP decal. Just like the original. 1963-64 Avanti, Lark, Hawk with jet thrust engine. Will also fit all 1962-64 V-8 with oil breather caps on rocker covers..... **\$45.50 ea.**

1558580 Orange oil breather cap with blue and white STP decal. Just like the original. Late 1962-64 V-8. Takes 2..... **\$45.50 ea.**

1564703 1965-66 6-cylinder. Not vented..... **\$12.50 ea.**

1564704 1965-66 V-8. Not vented... **\$12.50 ea.**

OIL FILTERS



196646 F-4 cartridge filter. 1938-62. 4 1/4" diameter. **\$24.90 ea.**

197482 F-3 cartridge filter. 1939-56. 3 3/4" diameter. **\$18.55 ea.**

AC-3300 Replacement spin-on filter above engine. 1957-62 6-cyl. & V-8. **\$15.10 ea.**



AC-3311 Replacement spin-on filter below engine. Late 1962-64 6-cyl. & V-8 all models & 1963-64 Avanti. **\$12.50 ea.**

SP-50057 Cartridge. 1956 Golden Hawk. NOS. **\$16.50 ea.**

1564488 1960-65 6-Cylinder. NOS with original lettering. Pictured..... **\$25.00 ea.**



OIL FILTER BASES

1555325 Oil filter base. 1957-early 1962..... **\$28.00 ea.**

1555680 Oil filter cover plate on block. All 1962-64 V-8 with full flow oil filter. **\$8.50 ea.**

1555771 Oil filter base. Late 1962-64 6-cyl. & V-8 & 1963-64 Avanti. **\$49.00 ea.**



OIL FILLER TUBES

195428 1939-50 Commander. Truck: M-16, 17, 2R - 5E with Commander 6-cylinder engine **\$30.00 ea.**

525922 1950-60 Champion 6-cylinder. **\$30.00 ea.**

531650 1951-54 V-8. **\$30.00 ea.**

1539054 1955-60 V-8..... **\$27.10 ea.**

1551495 1961-62 V-8. **\$25.00 ea.**

1564208 1965-66 V-8 without sealed PCV. **\$25.00 ea.**

1564705 1965-66 V-8 with sealed PCV. **\$25.00 ea.**

OIL PUMP

1539412 Oil pump. 1956-64 V-8. Rebuilt-exchange. (We must receive your rebuildable pump before this item ships)..... **\$225.00 Ex.**



1564031 Oil pump. 1965-66 6-cylinder..... **\$145.00 ea.**

OIL BREATHER

1564733 Adapter, oil breather without sealed PCV. 1965 - 66 V-8..... **\$5.00 ea.**

FLEXIBLE HOSES

Attaches to Oil Gauge & Engine Block
NOTE: Age, heat & deterioration often cause this hose to fracture, resulting in oil loss and engine failure. Check & replace frequently!



522329 1939-55 Champion 6 cars, 1956 to early 57 6-cyl Hawks, 1941-56 trucks with Champion engine..... **\$29.50 ea.**

522745 1941-59 car & truck with Commander engine **\$29.50 ea.**

530096 1951-66 V-8 car & truck & 1963-64 Avanti, all models with oil pressure gauge..... **\$14.00 ea.**

532339 Replacement less bracket. Late 1957-63 Champion. 1934-40 all & 1934-50 Presidents **\$24.50 ea.**

1562365 1965-66 6-cyl. **\$18.50 ea.**

ENGINE OIL DIPSTICKS & RELATED PARTS

519408 1947-49 Champion with cap ... **\$48.00 ea.**

520225 Dipstick. 1947-48 Commander & M16-M17 trucks after engine #3M-13510, 2R16, 17 trucks before engine #3R-15486..... **\$19.50 ea.**

523184 1949 Commander & 2r16-17 trucks after engine #3R15486 and before engine #4R-12946 .. **\$23.00 ea.**

525331 Dipstick. 1950 Commander & all 2R-5E truck models 3, 6, 11, 14. Also, 2R-5E models 16A-17A after engine #4R-12946 **\$23.40 ea.**

525645 1950 Commander. For models with extension tube. **\$19.50 ea.**

526411 Dipstick. 1951-54 Champion. **\$23.40 ea.**

530995 Dipstick. 1951-52 Commander & 3R28 & 38 model trucks **\$23.40 ea.**

533185 Dipstick. 1953-54 Commander C&K & E7, 12, 13 model trucks with standard transmission **\$19.50 ea.**

533209 Dipstick. 1953-54 Commander sedan & E38 trucks..... **\$19.50 ea.**

534727 Dipstick. 1956-57 6-cyl..... **\$19.50 ea.**

680204 Cap & Dipstick, Truck: 2R-3R, 5, 10, 15. **\$39.50 ea.**

1539890 Dipstick. 1956-64 V-8 **\$28.50 ea.**

1544477 Dipstick. 1958-64 6-cyl..... **\$19.50 ea.**

1558331 Dipstick. 1956-64 V-8 car & truck, 1963-64 Avanti. NOS with new chrome plating. **\$45.00 ea.**

1563473 Dipstick. All 1965- early 68 V-8 with power or disc brakes..... **\$16.00 ea.**

1563937 Dipstick. All 1965- early 66 V-8 without power brakes or disc brakes. Also late 1966 V-8..... **\$12.00 ea.**

OIL FILTER FLEXIBLE HOSES

Length measurement is in inches.

515710 Inlet, 28 1/4" length. 1947-50 Champion... **\$22.50 ea.**

521902 Inlet, 31" length. 1951-54 6-cylinder with cartridge type filter..... **\$37.50 ea.**

525927 Outlet, 8 1/2" length. 1947-54 6-cylinder with cartridge type filter **\$23.95 ea.**

525927 Outlet, 8 1/2" length. 1956-58 6-cylinder with cartridge type filter **\$22.50 ea.**

527309 Inlet, 37.39 CE 37" length. 1937-48 Commander. **\$38.50 ea.**

532565 Inlet, 9" length. For spin-on type filter and 1957-58 V-8, 1959-60 cars with A/C & 1959-60 cars with dealer installed filter V-8, only **\$23.75 ea.**

532565 Outlet, 9" length. Cartridge type filters on 1955-58 V-8 & 1959-60 V-8 without A/C & with factory installed filter..... **\$23.75 ea.**

536792 Inlet, 10 1/2" length. 1955-57 V-8 & 1959-60 V-8 with factory installed cartridge type filter.... **\$27.00 ea.**

1548288 Inlet, 17 3/4" length. 1959-60 6-cylinder with spin-on type filter..... **\$22.50 ea.**

1551563 Inlet. 1961-62 6-cylinder with spin on type filter. Also, 1961-62 V-8 with cartridge type filter. **\$22.50 ea.**

1551564 Outlet, 15" length. 1961-62 6-cylinder with spin-on filter. **\$22.50 ea.**

1551993 Inlet or outlet, 8". 1961-62 V-8 with spin-on filters..... **\$22.50 ea.**

1551994 19 1/2" length, inlet. 1961-62 6-cylinder with cartridge type filter **\$22.50 ea.**

NOTE : Many cars have had substituted hoses installed. For best results, measure what you need & order from the above list.

OIL FLEX TUBE BRASS ELBOW

199218 Brass elbow, cylinder head to oil flex tube. Oil line to gauge. 1963-64 Avanti..... **\$3.50 ea.**

OIL STRAINER TUBES

524964 1950 Champion **\$22.20 ea.**

525053 1950 Commander **\$22.20 ea.**

529267 1951-54 V-8 **\$18.50 ea.**

DIPSTICK TUBE

530994 1951-52 Commander. 1953-55 C&K..... **\$20.50 ea.**

533221 Upper. 1953-54 V-8 & 1955 except C&K **\$18.00 ea.**

1539871 Upper. 1956-58 V-8..... **\$20.50 ea.**

1544476 1958-59 6-cylinder with standard & overdrive transmissions, late 1959 w/auto. trans. and all 1960 6-cylinder **\$15.00 ea.**

1557692 Upper chrome, 1963-64 Lark & Hawk & 1963-64 Avanti with jet thrust engine, chrome ... **\$32.00 ea.**

INTAKE & EXHAUST VALVES



187171 Intake. 1932-33 Rockne. 1934-60 Dictator & Commander

6-cylinder. NOS. **\$24.25 ea.**

189820 Exhaust. 1932-33 Rockne. 1934-60 Dictator & Commander 6-cyl, 1932-42 Straight 8's **\$26.00 ea.**

194216 Intake. 1939-60 Champion, 6-cylinder. Stainless **\$25.00 ea.**

194217 Exhaust. 1939-60 Champion, 6-cylinder. Stainless **\$25.00 ea.**

440664 Exhaust. Standard 1956 Golden Hawk. NOS **\$25.00 ea.**

527693 Exhaust. 1951-54 V-8. NOS **\$24.00 ea.**

527694 Intake. 1951-54 V-8. NOS.... **\$18.00 ea.**

535939 Exhaust, standard duty. 1955-64 V-8. NOS **\$9.00 ea.**

680697 Intake. Commander 6-cylinder with rotary cap. **\$18.00 ea.**

683875 Exhaust, stainless. Heavy Duty, 1955-64 V-8. Avanti R-1, R-2, Standard..... **\$17.50 ea.**

683876 Intake, stainless. 1955-64 V-8. **\$17.00 ea.**

800534 Exhaust, stainless. Avanti R-3, R-4. **\$206.25/set 8**

800535 Intake, stainless. Avanti R-3, R-4..... **\$157.50/set 8**

1550591 Intake. 1961-64 6-cylinder..... **\$18.75 ea.**

1550592 Exhaust. 1961-64 6-cylinder. **\$24.00 ea.**

1563982 Intake, standard. All 1965 - 66. NOS.. **\$5.00 ea.**

1564157 Exhaust, standard. 1965 6-cylinder & 8-cylinder. NOS **\$5.00 ea.**

1564362 Exhaust. .003 1965 6-cylinder & V-8. NOS **\$5.00 ea.**

1564363 Exhaust, .015 1965 6-cylinder & V-8. NOS **\$5.00 ea.**

1564364 Exhaust, .030 1965 6-cylinder & V-8. NOS **\$5.00 ea.**

1564396 Intake, .003 all 1965 - 66 6-cylinder & V-8. NOS **\$5.00 ea.**

1564397 Intake. .015 all 1965 - 66 6-cylinder & V-8. NOS **\$5.00 ea.**

1565711 Exhaust, standard. 1966 6-cylinder & V-8. NOS..... **\$5.00 ea.**

1565712 Exhaust, .003 1966 6-cylinder & V-8. NOS **\$5.00 ea.**

1565713 Exhaust, .015 1966 6-cylinder & V-8. NOS **\$5.00 ea.**

1565714 Exhaust, .030 1966 6-cylinder & V-8. NOS **\$5.00 ea.**

VALVE RELATED PARTS

174837 Valve retainer clips. 1935-60 Commander 6-cylinder. **\$6.00 pr.**

195286 Valve retainer clip. 1939-60 Champion. **\$8.00 ea.**

195616 Lifter spring, 1939-60 Champion 6-cylinder..... **\$12.50 ea.**

526204 Lifter spring. 1947-60 Commander 6-cylinder. **\$4.75 ea.**



527138 Valve lifter cover. 1951-64 V-8. Valley Cover. **\$30.00 ea.**

527180 Valve retainer clip. 1951-64 V-8 car & truck & 1963-64 Avanti. 1961-64 OHV 6-cylinder. **\$1.00 pr.**

527184 End plug, rocker shaft arm. 1951-64 V-8 car & truck & 1963-64 Avanti. Takes 4. 1961-64 OHV 6-cylinder. Takes 2 **\$1.00 ea.**

527890 Push rod. 1951-early 61 V-8. **\$9.00 ea.**

532161 Tappet adjusting screw. 1952-56 V-8 **\$8.70 ea.**

532177 Rocker arm. 1952-54 V-8..... **\$21.60 ea.**

534890 Valve spring cover, rear. 1954-60 6-cylinder Champion..... **\$15.00 ea.**



534892 Valve spring cover, front. 1939-60 6-cylinder Champion..... **\$15.00 ea.**

536222 Rocker arm. 1955 -early 1961 V-8..... **\$18.00 ea.**

682695 Rotator cap. 1955-64 V-8 heavy duty exhaust valve **\$26.50 ea.**

1541806 Rocker adjusting screw. 1957-early 1961 V-8. **\$7.50 ea.**

1544591 Spring retainer. 1958-64 V-8 car & truck & 1963-64 Avanti. 1961-64 OHV 6-cylinder. **\$4.65 ea.**

1550360 Rocker adjusting screw. Late 1961-64 all models car & truck & 1963-64 Avanti. **\$9.75 ea.**

1564103 Cover, valve lifter & push rod. 1965-66 6 - cylinder **\$8.00 ea.**

1564106 Arm, valve rocker. 1965 - 66 with 6-cylinder engine **\$4.00 ea.**

1564260 Arm, valve rocker. 1965 - 66 V-8..... **\$5.00 ea.**

1564261 Ball, valve rocker arm. 1965 - 66 V-8. **\$4.00 ea.**

VALVE LIFTER COVER GASKETS

(Valley Cover Gasket)

196126 1935-60 Commander 6-cyl. **\$16.90 pr.**

536554 1939-64 Champion 6-cyl. **\$18.05 pr.**

1561169 1951-64 V-8 & 1963-64 Avanti..... **\$17.90 ea.**



VALVE STUD COVER GROMMET

530858 1961-64 6-cyl. & 1951-64 V-8 & 1963-64 Avanti **\$1.90 ea.**



ROCKER COVER

1550637 Rocker cover, 1961-64 OHV 6-cylinder. **\$41.50 ea.**

1552106 4-hole rocker cover, 1959-60 V-8. Will also fit 1951-58 V-8..... **\$65.00 ea.**

1564496 rocker cover, 1965 - 66 6-cylinder..... **\$35.00 ea.**

ROCKER COVER GASKETS

Sets include grommets



536555X 1951-early 1960 V-8. Composition. Includes 8 stud grommets..... **\$48.00 pr.**

1561165 Late 1951-1964 V-8 & 1963-64 Avanti. Neoprene. Includes 4 stud grommets. **\$36.00 pr.**

1561165X Late 1960-64 V-8 & 1963-64 Avanti. Composition. Includes 4 stud grommets **\$27.30 pr.**

1561167 1961-64 6-cylinder. Neoprene. Grommets are not included..... **\$15.00 ea.**

CHROME ROCKER COVER NUTS



1-101 Original on 1963-64 Avanti and an attractive addition on others. Set contains 4 chrome acorn nuts and 4 chrome washers. Will fit 1951-64 V-8 & 6-cylinder. **\$15.00/set 4**

V-8 ENGINE DRESS-UP

Won't Fit 232 V8's



801458 Finned V-8 rocker covers without breather tubes. **\$330.00 pr.**

801459 Finned V-8 rocker covers with breather tubes. Caps are not included **\$330.00 pr.**

801460 Finned V-8 Valley cover with hole for breather. **\$140.00 ea.**

801461 Finned oil filler block off plate..... **\$20.00 ea.**

801550 Finned V-8 Valley cover without hole for breather **\$155.00 ea.**

802291 Finned V-8 valley cover with threaded hole for PC V, 1964..... **\$140.00 ea.**

VALVE SEATS

NOTE: These premium grade valve seats are suitable for use with unleaded fuels.



- 800551** Inlet. 1955-64 V-8 car & truck & 1963-64 Avanti R-1. **\$56.75/set 8**
- 800552** Exhaust. 1955-64 V-8 car & truck & 1963-64 Avanti R-1. **\$49.75/set 8**
- 800553** Inlet. V-8 with supercharger & 1963-64 Avanti R-2. **\$82.25/set 8**
- 800554** Exhaust. V-8 with supercharger & 1963-64 Avanti R-2. **\$82.80/set 8**
- 800566** Inlet. 1939-60 Champion 6-cylinder. **\$38.25/set 6**
- 800567** Exhaust. 1939-60 Champion 6-cylinder. **\$38.25/set 6**
- 800568** Inlet. 1961-64 6-cylinder. **\$58.00/set 6**
- 800569** Exhaust. 1961-64 6-cylinder. **\$40.50/set 6**
- 800570** Inlet. 1939-50 Commander 6-cylinder. **\$42.50/set 6**
- 800571** Exhaust. 1939-50 Commander 6-cylinder. **\$42.50/set 6**
- 800572** Inlet. 1951-54 V-8. Truck: 3R 28, 38. **\$54.00 set/8**
- 800573** Exhaust. 1951-54 V-8. **\$55.00/set 8**

VALVE STEM SEALS

- 527191** 1951-54 V-8. **78¢ ea.**
- 536264** 1955-64 V-8 & 1963-64 Avanti & 1961-64 6-cyl. **\$1.10 ea.**

VALVE SPRINGS



- 188645** 1936-60 Commander 6-cylinder, 1963-64 Avanti jet thrust V-8. **\$8.00 ea.**
- 514236** 1939-60 Champion 6-cylinder. **\$11.00 ea.**
- 530418** 1936-60 Commander 6-cylinder with rotary cap. **\$8.00 ea.**
- 533245** 1951-64 V-8 except Avanti. 1961-64 OHV 6-cylinder. **\$8.00 ea.**
- 682708** 1954-64 V-8 exhaust with rotary cap. **\$8.50 ea.**
- 1564871** 1965-66 6-cylinder. **\$8.00 ea.**



VALVE LIFTERS

- 518407** 1947-48 Commander 6-cylinder. **\$21.00 ea.**
- 522655** 1939-60 Champion 6-cylinder. Pictured. **\$150.00/set 12**
- 524596** 1949-60 Commander 6-cylinder. **\$21.00 ea.**
- 1549247** 1961-64 6-cylinder. 1955-64 V-8 & 1963-64 Avanti. **\$10.25 ea.**

NOTE: Some oversize lifters are available. Please inquire.

VALVE GUIDES



- 186666** Intake & exhaust. 1939-60 Commander 6-cylinder. ... **\$142.60/set 12**
- 194359** Intake & exhaust. 1939-60 Champion 6-cylinder. NOS. **\$52.00/set 12**
- 527088** Intake. 1961-64 6-cylinder. & 1951-64 V-8 & 1963-64 Avanti. **\$6.75 ea.**
- 530222** Exhaust. 1951-64 V-8 including Avanti. **\$6.50 ea.**
- 1552301** Exhaust. 1961-64 6-cylinder. **\$56.00/set 6**

VALVE GRIND GASKET SETS

Contains upper engine gaskets & seals required when rebuilding cylinder heads & valves.

- 800388** 1961-64 6-cylinder. **\$129.00/set**
- 800389** 1939-60 Champion 6-cylinder. **\$92.00/set**
- 800390** 1938-60 Commander 6-cylinder. **\$138.00/set**
- 800391*** 1961-64 V-8 includes Avanti. Comes with thin head gaskets. **\$167.00 set**
- 800975** 1951-54 V-8. **\$124.00 set**
- 802255** Late 1960 V-8. **\$167.00/set**
- 802256** 1955-early 1960 V-8. **\$162.00/set**

HEAT RISER VALVES & PARTS



- 179369** Screw, valve to shaft. 1961-64 OHV 6-cylinder. **\$5.25 ea.**
- 196414** Gasket, heat riser valve. 1939-60 Champion 6-cylinder. **\$6.50 ea.**
- 196655** Valve & shaft. 1939-60 Champion 6-cylinder. **\$22.50 ea.**
- 196661** Thermostat. 1939-60 Champion 6-cylinder. **\$12.00 ea.**
- 196662** Balance weight. 1939-60 Champion 6-cylinder. **\$12.50 ea.**
- 199140** Screw, balance retainer. 1950-60 Commander 6-cylinder. **\$6.50 ea.**
- 1554197** Valve bushings. 1942-64, 6-cylinder. Truck: M5-8E 6-cylinder. **\$11.00 ea.**
- 515832** Valve cover plate. 1942-64 Champion engine. **\$55.00 ea.**
- 515835** Balance weight. 1950-60 Commander 6-cylinder. **\$11.25 ea.**
- 520458** Plug. 1939-60 Champion. **\$5.50 ea.**
- 525315** Shaft. Late 1950-60 Commander 6-cylinder. **\$18.50 ea.**
- 525316** Thermostat. Late 1950-60 Commander 6-cylinder. **\$11.00 ea.**
- 525317** Pin, thermostat anchor. **\$3.00 ea.**
- 525319** Spring, anti-rattle. Late 1950-60 Commander 6-cylinder. **\$5.25 ea.**
- 530009** Thermostatic spring. All 1951-64 V-8. ... **\$15.00 ea.**
- 533118** 1951-54 V-8. NOS. **\$150.00 ea.**
- 536171** Replacement valve. 1955-64 V-8 (complete) & 1963-64 Avanti. **\$80.00 ea.**
- 1551446** Valve. 1961-64 6-cylinder. **\$12.00 ea.**
- 1551986** Thermostat. 1961-64 6-cylinder. **\$12.00 ea.**
- 1554197** Bushing. 1961-64 OHV 6-cylinder. **\$8.25 ea.**
- 1554198** Shaft. 1962-64 6-cyl. **\$19.00 ea.**
- 1564075** Shaft. 1965-66 6-cylinder. **\$3.00 ea.**

HEAT RISER COMPLETE VALVE KITS

1939-60 Champion 6-cylinder

Kit includes:

- 196414 gasket
- 196655 valve & shaft
- 196661 thermostat
- 196662 balance weight. plus set screw
- 1554197 bushing (2)
- 520458 plug

Total of all parts if purchased separately **\$75.50 ea.**

801354
Special Package Price **\$68.00 ea.**

1961-64 O.H.V. 6-cylinder

Kit includes:

- 179369 screw
- 196662 balance weight
- 1554197 bushing (1) plus set screw
- 1551446 valve
- 1551986 thermostat
- 1554197 bushing
- 1554198 shaft

Total of all parts if purchased separately **\$87.50 ea.**

801355
Special Package Price **\$79.00 ea.**

Late 1950-60 Commander 6-cylinder

Kit includes:

- 179369 screw
- 199006 screw
- 1554197 bushing (2)
- 515835 balance wt.
- 525315 shaft
- 525316 thermostat
- 525317 pin
- 525319 spring

Total of all parts if purchased separately **\$103.75 ea.**

801356
Special Package Price **\$94.00 ea.**

MANIFOLD INTAKE & EXHAUST



- 529489** Right exhaust manifold. 1951-54 V-8 **\$130.00 ea.**
- 529490** Left exhaust manifold. 1951-52 V-8 **\$120.00 ea.**
- 802446** WCFB 4-barrel intake manifold..... **\$225.00 ea.**
- 1559666** Right exhaust manifold. All 1955-62 V-8..... **\$108.00 ea.**
- 536195** Left exhaust manifold. All 1955-64 V-8..... **\$175.00 ea.**
- 1551330** Intake, 1960-64. 2-bbl V-8..... **\$85.00 ea.**
- 1551449** Exhaust, 1961-64 OHV 6-cylinder Includes heat riser..... **\$150.00 ea.**
- 1558255** Right exhaust manifold. 1963-64 Avanti..... **\$180.00 ea.**
- 1559666** Right exhaust, 1963-64 except Avanti. V-8..... **\$108.00 ea.**

INTAKE & EXHAUST MANIFOLD GASKETS



- 177976** 1933-34 Commander 8 & 1934-42 President 8..... **\$22.00 pr.**
- 196693** Intake & exhaust, 6-cylinder. 1939-60 Champion. NOS..... **\$18.00 ea.**
- 510066** Intake & exhaust, 6-cylinder. 1935-60 Commander..... **\$29.70 ea.**
- 530266** Metal intake. 1951-64 V-8 & 1963-64 Avanti..... **\$13.50 pr.**
- 801233** Composition intake. 1951-64 V-8 & 1963-64 Avanti..... **\$21.30 pr.**
- 800397** Metal exhaust. 1955-64 V-8 & 1963-64 Avanti..... **\$33.25/set 9**
- 800397X1** Exhaust manifold. 1951-64 V-8..... **\$17.50/set 9**
- 801246** Composition exhaust. 1955-64 V-8 & 1963-64 Avanti..... **\$26.70/set 9**
- 1551403** Inlet to exhaust manifold. 1961-64 6-cylinder..... **\$7.25 ea.**
- 1551869** Manifold to block. 1961-64 6-cylinder..... **\$15.00 ea.**
- 1555713** Composition intake. 1963-64 Avanti R-3; R-4..... **\$16.00 pr.**
- 1564080** Inlet to exhaust. 1965-66 6-cylinder..... **\$1.50 ea.**
- 1564084** Inlet & exhaust manifold to head. 1965-66 6-cylinder..... **\$3.00 ea.**

CAST IRON HEADERS



- 801092** Standard on 1963-64 Avanti R-3 & R-4, optional on R-1 & R-2. Improves performance and increases fuel economy on all V-8 equipped Studebaker..... **\$395.00 pr.**
- 801093** Header to exhaust pipe. Used with 801092. Stainless..... **\$200.00 pr.**
- 801209** Alternator/generator bracket for mounting 801092 headers in Lark or Hawk. Not needed for Avanti..... **\$85.50/kit**



PRE-WAR MANIFOLD GASKETS

- 43494** Exhaust pipe flange gasket. 1928-32 all 6-cylinder **\$10.00 ea.**
- 156526** Exhaust pipe flange gasket. 1929-32 President 8..... **\$10.00 ea.**
- 168653** Divider gasket, inlet to exhaust manifold. 1931-32 Dictator 8 & 1930-32 Commander 8 **\$10.00 ea.**
- 172436** Divider gasket, inlet to exhaust manifold. 1932 Rockne 85 and 1931-32 Studebaker 54-55. **\$10.00 ea.**
- 178230** Divider gasket, inlet to exhaust manifold. 1933 Commander & President 8..... **\$10.00 ea.**
- 178270** Divider gasket, inlet to exhaust manifold. 1933 Studebaker 56..... **\$10.00 ea.**
- 184778** Divider gasket, inlet to exhaust manifold. 1934 Dictator..... **\$10.00 ea.**
- 185075** Divider gasket, inlet to exhaust manifold. 1935 Dictator..... **\$10.00 ea.**

- 187003** Divider gasket, inlet to exhaust manifold. 1936-42 Dictator & Commander 6-cylinder..... **\$10.00 ea.**

- 510066** Block to manifold. 1934-42 Dictator & Commander 6-cylinder..... **\$29.70 ea.**

- 633100** Exhaust pipe flange gasket. 1933 Studebaker 6-cylinder & 1933-42 8-cylinder..... **\$10.00 ea.**

- 680291** Exhaust pipe flange gasket. 1939-46 Champion..... **\$4.00 ea.**

- 680292** Exhaust pipe flange gasket. 1936-42 Commander 6-cylinder..... **\$5.75 ea.**



MANIFOLD INTAKE CLAMP

- 535617P** 1951-64 V-8 car & truck & 1963-64 Avanti. Takes 4..... **\$4.00 ea.**

WATER PUMP MANIFOLD SEALS

- 527240** Water pump manifold seal. Upper, 1951-64 V-8 & 1963-64 Avanti. Takes 2. Temperature sender plate. Takes 2..... **\$1.65 ea.**
- 527856** Water pump manifold seal. Lower, 1951-64 V-8 & 1963-64 Avanti. Takes 2..... **\$1.60 ea.**

U-BOLT & SADDLE ASSEMBLY

- 1547588** Clamp. Header pipe to exhaust pipe. 1959-64 V-8 including Avanti. Takes 2..... **\$32.00 ea.**



EXHAUST DEFLECTORS



AC-2754
Originally available on 1956-57 Hawks and Station Wagons.

Chrome finish. Dresses up tailpipe and prevents exhaust gases from marring car finish..... **\$85.00 ea.**

AC-2771 Chrome exhaust tip. 1956 sedan, not Hawk. NOS..... **\$35.50 ea.**



AC-2840 Original factory accessory 1957-64 Hawk & 1957-58 sedan. Excellent quality stainless steel reproduction..... **\$119.95 ea.**



AC-3339 1963-85 Avanti. Chrome... **\$65.00 ea.**

www.studebaker-intl.com

FLANGE REPAIR KITS



800236 1939-60 Champion 6-cyl. Contains 2 new studs, washers, brass nuts and a composition gasket..... **\$12.50 ea.**

800266 1955-64 V-8 all models & 1963-64 Avanti. Contains 4 new studs, washers, brass nuts & 3 composition gaskets..... **\$16.50 ea.**

800266X1 1951-54 V-8 all models. Contains 4 new studs, washers, brass nuts & 3 gaskets..... **\$16.50 ea.**

800791 1938-50 Commander 6-cylinder & all Commander 6-cylinder truck through 1960 with 2 bolt flange. Contains 2 new studs, washers, brass nuts & a composition gasket..... **\$12.50 ea.**

802435 Mounting kit for headers..... **\$25.50/kit**

MANIFOLD GUARD

1564233 Guard, intake manifold oil splash. 1965 - 66 V-8..... **\$10.00 ea.**



New old stock MUFFLERS

Availability on these items ranges from just a few to a dozen or more.

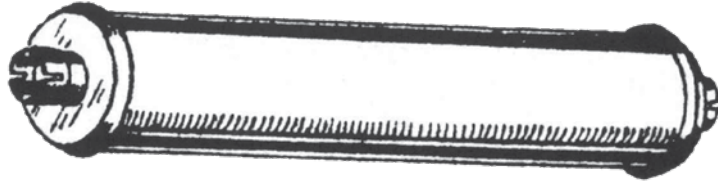

- 127404** 1928 - 29 Dictator 6 and 1929 Commander 6. Models with GE and GJ..... **\$250.00 ea.**
- 167984** 1929 - 30 model GL Dictator 6, prior to serial number 1, 475,137 **\$250.00 ea.**
- 173125** 1930 Dictator 6 after serial number 1,475,137..... **\$250.00 ea.**
- 173649** 1932 Studebaker 6, model 55..... **\$250.00 ea.**
- 180879** 1934 President..... **\$250.00 ea.**
- 184256** 1935 Dictator..... **\$250.00 ea.**
- 184618 & 512212** 1935 Commander 8 and early 1936 President, front..... **\$250.00 ea.**
- 184619** Front for late 1936 President..... **\$250.00 ea.**
- 184620** 1935 Commander 8 and 1935-36 President, rear..... **\$250.00 ea.**
- 187510** 1936 Dictator..... **\$250.00 ea.**
- 197413** 1939-41 Champion..... **\$150.00 ea.**
- 198408** 1937-48 President..... **\$250.00 ea.**
- 198503** 1937-42 Dictator and Commander. Also 1937-39 Coupe Express..... **\$250.00 ea.**
- 199485** 1941-42 President..... **\$250.00 ea.**

- 515656** 1942-46 Champion..... **\$125.00 ea.**
- 521214** 1935 Dictator..... **\$250.00 ea.**
- 536409** 1955 V-8 with single exhaust..... **\$125.00 ea.**
- 661556** 1941-64 truck with Commander 6-cylinder engine..... **\$166.50 ea.**
- 663647** ½ ton & ¾ ton 1941-64 truck with Champion 6-cylinder engine..... **\$166.50 ea.**
- 682148** 1954-56 truck, 3R-2E 13, 28, & 38..... **\$150.00 ea.**
- 684435** 1955-64 truck, E-8E 2, 7, & 12..... **\$150.00 ea.**
- 1549213** 1955 with single exhaust. Aluminized..... **\$125.00 ea.**
- 1554308** 1962-66 6-cylinder Lark, 4-door all except station wagon with sliding roof..... **\$125.00 ea.**
- 1555447** 1962-66 6-cylinder Lark, 4-door all except station wagon with sliding roof. Aluminized..... **\$125.00 ea.**
- 1687675** 1957-64 truck. 3E-8E 13, 28, 38, & 40..... **\$150.00 ea.**

HEAD REBUILD KITS

FOR 1955-64 259 & 289 V-8

Kit includes:

- 1 valve grind gasket kit
- 8 exhaust valves
- 8 intake valves
- 8 exhaust valve seats
- 8 intake valve seats
- 8 exhaust valve guides
- 8 intake valve guides
- 16 valve springs
- 4 rocker arm end plugs & cotter pins
- 1 can aerosol engine enamel
- 1 silicone gasket sealer (tube)

1955-64 259 or 289 V-8 except Avanti

Total of all parts listed if purchased separately ... **\$717.50**

801028R Your cost **\$713.00 ea.**

1957-58 289 V-8 with supercharger

Total of all parts listed if purchased separately ... **\$743.00**

801029R Your cost **\$756.00 ea.**

1963-64 Avanti jet thrust R-1

Total of all parts listed if purchased separately ... **\$714.25**

801168R Your cost **\$717.00 ea.**

1963-64 Avanti jet thrust R-2 supercharged

Total of all parts listed if purchased separately ... **\$739.75**

801169R Your cost **\$761.00 ea.**

NOTE : When ordering specify year and model of car. No substitutions or deletions.

EXHAUST STRAPS & SUPPORTS

- 189393** Tail pipe support rubber strap. 1937-42 Commander & President. 1939-46 Champion. Muffler support. 1941-64 truck..... **\$8.00 ea.**
- 517913** Hanger, outlet pipe 1947-49 Champion **\$7.25 ea.**
- 517914** Tail pipe hanger rubber strap. 1947-50 all models. 1953 all models. **\$5.00 ea.**



- 800543** Rear support strap & brackets. 1960- 64 convertible. 1963-66 Wagonaire. Includes 1553904 strap..... **\$22.00 ea.**



- 800543X1** 1963-85 Avanti..... **\$33.00 ea.**

- 1544725** Rear strap with bracket. Most models & 1963-85 Avanti. Pictured, right..... **\$5.20 ea.**



- 1553904** Rear support strap. 1960-64 convertible. 1963-66 Wagonaire & 1963-85 Avanti... **\$3.95 ea.**



- 518002** Hanger, outlet pipe 1947-49 Commander..... **\$9.00 ea.**
- 526460** Tail pipe hanger rubber strap. 1949-50 Commander, 1950 Champion, 1951-66 most models..... **\$5.50 ea.**
- 532466** Hanger, outlet. 1953 Commander sedan..... **\$9.00 ea.**
- 532471** Hanger, outlet. 1953 Champion sedan.. . . . **\$9.00 ea.**

EXHAUST FLANGE SEAL GASKETS

- 680291** 1939-64 Champion 6-cyl..... **\$2.50 ea.**
- 680292** Exhaust pipe flange gasket. 1936-50 car with Commander 6, Truck: 1934-60 with Commander 6. (2 hole) **\$2.50 ea.**
- 680847** Truck: 2R & E-5E, 3, 6, 11, 14, 16, 17. (3 hole)..... **\$2.00 ea.**
- 800398** 1955-64 V-8. Thick composition type. All models & 1963-64 Avanti. **\$2.75 ea.**
- 530263** 1951-54 V-8. Metal. **\$4.25 ea.**

As always, if you don't see what you need, please call **(317) 462-3124 & inquire**

PRE-WAR MANIFOLD HEATER VALVE COVER GASKETS

- 170052** 1930 Studebaker 6-cylinder **\$8.00 ea.**
- 177731** All 1933 8-cylinder **\$8.00 ea.**
- 180054** 1934-42 8-cylinder..... **\$8.00 ea.**
- 183640** 1935 Dictator 6-cylinder..... **\$8.00 ea.**
- 510068** 1932-33 Rockne 65 & 75 and 1934 Dictator 6-cylinder **\$8.00 ea.**



1936-37 DICTATOR

Without rear main seal

Total of all parts listed if purchased separately.....\$221.85

801270
Special Kit Price.....\$195.00/set

Kit includes:

- 2 Ea. G113897 Oil pressure relief & oil pan plug
- 1 Ea. 167156 Crankshaft washer, front
- 1 Ea. 172622 Oil pump cover
- 1 Ea. 186668 Timing gear cover
- 1 Ea. 186710 Oil pan
- 1 Ea. 187003 Manifold divider
- 2 Ea. 187106 Rear main bearing cap (Wood)
- 1 Ea. 197389 Fuel pump
- 1 Ea. 189163 Water pump
- 1 Ea. 189326 Water pump
- 1 Ea. 192105 Carburetor base
- 1 Ea. 510131 Distributor
- 1 Ea. 510193 Oil pump body
- 1 Ea. 523145 Front plate
- 1 Set 800390

Valve Grind Gasket Set

(Includes the following)

- 1 Ea. 186888 Thermostat
- 1 Ea. 510066 Intake and exhaust manifold
- 1 Ea. 527057 Cylinder head
- 1 Pr. 196126 Valve lifter cover & 4 ea. 156768 with screw gaskets

1939-47 CHAMPION

Without rear main seal

Total of all parts listed if purchased separately.....\$232.47

801269
Special Kit Price.....\$205.00/set

Kit includes:

- 1 Set S-346 Oil pan
- 1 Ea. G113897 Oil pan plug washer
- 1 Ea. 192125 Oil pressure relief washer
- 1 Ea. 194219 Front cover
- 1 Ea. 194484 Front plate
- 1 Ea. 195304 Oil pump (Body)
- 1 Ea. 196414 Heat riser valve cover
- 2 Ea. 197178 Rear main cap (Wood)
- 1 Ea. 197591 Front crankshaft
- 1 Ea. 510131 (1561173) Distributor
- 1 Ea. 521371 Oil pump (Cover)
- 1 Ea. 522070 Carburetor base
- 2 Ea. 522144 Rear main cap
- 1 Ea. 534123 Oil pump suction
- 1 Ea. 534597 Water pump
- 1 Ea. 680291 Pipe flange
- 1 Set 800389

Valve Grind Gasket Set

(Includes the following)

- 1 Ea. 194194 PCV valve adapter (Breather Tube)
- 1 Ea. 194658 Thermostat (Upper)
- 1 Ea. 194660 Thermostat (Lower)
- 1 Ea. 196693 Intake and exhaust manifold
- 1 Ea. 534598 Cylinder head
- 1 Pr. 536554 Valve lifter cover & 4 ea. 156768 with screw gaskets

1948 COMMANDER, M16 17 & EARLY 2R 16 & 17 TRUCKS WITH 226 CUBIC INCH 6-CYL.

Includes rear main seal

Total of all parts listed if purchased separately.....\$265.60

801271
Special Kit Price.....\$235.00/set

Kit includes:

- 2 Ea. G113897 Oil pressure relief and oil pan plug
- 1 Ea. 167156 Crankshaft washer, front
- 1 Ea. 172622 Oil pump cover
- 1 Ea. 186668 Timing gear cover
- 1 Ea. 186710 Oil pan
- 1 Ea. 187003 Manifold divider
- 2 Ea. 187106 Rear main bearing cap (Wood)
- 1 Ea. 192105 (522070) Carburetor base
- 1 Ea. 197389 Fuel pump
- 1 Ea. 510131 Distributor
- 1 Ea. 510193 Oil pump body
- 1 Ea. 519371 Water pump
- 1 Ea. 519434 Water pump
- 2 Ea. 522144 Rear main bearing cap (Rubber)
- 1 Ea. 523145 Front plate
- 1 Ea. 525945 Rear main
- 1 Ea. 680292 Exhaust pipe flange
- 1 Set 800390

Valve Grind Gasket Set

(Includes the following)

- 1 Ea. 186888 Thermostat
- 1 Ea. 510066 Intake and exhaust manifold
- 1 Ea. 527057 Cylinder head
- 1 Pr. 196126 Valve lifter cover & 4 ea. 156768 with screw gaskets

1949-60 COMMANDER

With rear main seal

Total of all parts listed if purchased separately.....\$269.60

801272
Special Kit Price.....\$240.00/set

Kit includes:

- 2 Ea. G113897 Oil pressure relief & oil pan plug
- 1 Ea. 167156 Crankshaft washer, front
- 1 Ea. 526203 Oil pump cover
- 1 Ea. 186668 Timing gear cover
- 1 Ea. 186710 Oil pan
- 1 Ea. 187003 Manifold divider
- 1 Ea. 191662 (523145) Front plate
- 1 Ea. 197389 Fuel pump
- 1 Ea. 510131 Distributor
- 1 Ea. 510193 Oil pump body
- 1 Ea. 519371 Water pump
- 1 Ea. 519434 Water pump
- 1 Ea. 522070 Carburetor base
- 1 Ea. 680292 Exhaust pipe flange OR (2 stud mounting holes)
- 1 Ea. 680847 Exhaust pipe flange (Trucks with 3 stud mounting holes)
- 1 Ea. 1540603 Rear main
- 1 Set 800390

Valve Grind Gasket Set (Includes the following)

- 1 Ea. 186888 Thermostat
- 1 Ea. 510066 Intake and exhaust manifold
- 1 Ea. 527057 Cylinder head
- 1 Pr. 196126 Valve lifter cover & 4 ea. 156768 with screw gaskets

1938-47 6-CYL. COMMANDER

Without rear main seal

Total of all parts listed if purchased separately.....\$220.60

800385
Special Kit Price.....\$195.00/set

Kit includes:

- 2 Ea. G113897 Oil pressure relief and oil pan plug
- 1 Ea. 167156 Crankshaft washer, front
- 1 Ea. 172622 Oil pump cover
- 1 Ea. 186668 Timing gear cover
- 1 Ea. 186710 Oil pan
- 1 Ea. 187003 Manifold divider
- 2 Ea. 187106 Rear main bearing cap (Wood)
- 1 Ea. 191662 (523145) Front plate
- 1 Ea. 197389 Fuel pump
- 1 Ea. 510131 Distributor
- 1 Ea. 510193 Oil pump body
- 1 Ea. 519371 Water pump
- 1 Ea. 519434 Water pump
- 1 Ea. 522070 Carburetor base
- 2 Ea. 522144 Rear main bearing cap (Rubber)
- 1 Ea. 680292 Exhaust pipe flange (2 stud mounting holes)
- 1 Set 800390

Valve Grind Gasket Set

(Includes the following)

- 1 Ea. 186888 Thermostat
- 1 Pr. 196126 Valve lifter cover & 4 ea. 156768 with screw gaskets
- 1 Ea. 510066 Cylinder head
- 1 Ea. 527057 Intake and exhaust manifold

1948-54 6-CYL. CHAMPION

With rear main seal

Total of all parts listed if purchased separately.....\$304.87

800383
Special Kit Price.....\$270.00/set

Kit includes:

- 1 Ea. 1540604 Rear main
- 1 Set S-346 Oil pan
- 1 Ea. G113897 Oil pan plug washer
- 1 Ea. 192125 Oil pressure relief washer
- 1 Ea. 194219 Front cover
- 1 Ea. 194484 Front plate
- 1 Ea. 195304 Oil pump (Body)
- 1 Ea. 196414 Heat riser valve cover
- 1 Ea. 197591 Front crankshaft
- 1 Ea. 510131 (1561173) Distributor
- 1 Ea. 521371 Oil pump (Cover)
- 1 Ea. 522070 Carburetor base
- 1 Ea. 534123 Oil pump suction
- 1 Ea. 534597 Water pump
- 1 Ea. 680291 Pipe flange
- 1 Set 800389

Valve Grind Gasket Set

(Includes the following)

- 1 Ea. 194194 Breather Tube
- 1 Ea. 194658 Thermostat (Upper)
- 1 Ea. 194660 Thermostat (Lower)
- 1 Ea. 196693 Intake and exhaust manifold
- 1 Ea. 534598 Cylinder head
- 1 Pr. 536554 Valve lifter cover & 4 ea. 156768 with screw gaskets

1955-EARLY 1960 V-8

With rear main seal

Total of all parts listed if purchased separately.....\$320.70

800386*

Special Kit Price.....\$285.00/set

Kit includes:

- 1 Ea. G113897 Oil pan plug (1955 - 1958)
- OR 1 Ea. 1552264 Oil pan plug (1959)
- 3 Ea. 156768 Valve lifter cover screw
- 1 Ea. 167156 Crankshaft washer, front
- 1 Ea. 192125 Oil pressure relief
- 1 Ea. 440613 Carburetor base (4BBL)
- 1 Ea. 527224 Oil pump
- 1 Ea. 533010 Distributor
- 1 Ea. 535697 Filler tube
- 1 Ea. 537354 Fuel pump
- 1 Set 802256

Valve Grind Gasket Set

(Includes the following)

- 1 Ea. 510550 Breather tube
- 3 Ea. 527240 Water pump manifold, upper
- 1 Ea. 527246 Water pump
- 1 Ea. 527284 Thermostat
- 2 Ea. 527856 Water pump manifold, lower
- 1 Pr. 530266 Intake manifold
- 16 Ea. 536264 Valve stem
- 1 Pr. 536555X Rocker cover
- Includes (8) 530858 grommets
- 1 Set 801246 Exhaust manifold
- 2 ea. 1545072 (Included) Cylinder head
- OR 535982 Add \$35.00 for thicker Cylinder head gaskets

- 1 Ea. 1540006 Carburetor base (2BBL)
- 1 Ea. 1559366 Rear main
- 1 Ea. 1561166 Front cover
- 1 Set 1561169 Valve lifter cover
- 1 Ea. 1561465 Oil pan

1951-54 V-8 COMMANDER

With rear main seal

Total of all parts listed if purchased separately.....\$283.73

800387

Special Kit Price.....\$255.00/set

Kit includes:

- 1 Ea. G113897 Oil pan plug washer
- 1 Ea. 167156 Crankshaft washer, front
- 1 Ea. 177979 (use 684059) Carburetor base
- 1 Ea. 192125 Oil pressure relief
- 1 Ea. 197389 Fuel pump
- 1 Ea. 527214 Distributor
- 1 Ea. 527224 Oil pump
- 1 Ea. 527246 Water pump
- 1 Ea. 531640 Fuel pump support
- 1 Set 800975

Valve Grind Gasket Set

(Includes the following)

- 1 Ea. 510550 Breather tube
- 3 Ea. 527240 Water pump manifold, upper
- 1 Ea. 527284 Thermostat
- 2 Ea. 527856 Water pump manifold, lower
- 1 Pr. 530266 Intake manifold
- 16 Ea. 527191 Valve stem
- 1 Set 800397X1 Exhaust manifold
- 2 Ea. 529321 Cylinder head
- 1 Pr. 536555X Rocker cover
- & 8 ea. 530858 with valve cover grommets

- 1 Ea. 1559366 Rear main seal
- 1 Ea. 1561166 Timing cover
- 1 Set 1561169 Valve lifter cover
- With screw gaskets (3)
- 1 Ea. 1561465 Oil pan

1955-60 6-CYL. CHAMPION

With rear main seal

Total of all parts listed if purchased separately.....\$268.50

800384 Special Kit Price.....\$240.00/set

Kit includes:

- 1 Ea. G113897 Oil pan plug washer (1955-58)
- OR 1552204 Oil pan plug washer (1959-60)
- 1 Ea. 192125 Oil pressure relief
- 1 Ea. 195304 Oil pump body
- 1 Ea. 196414 Heat riser valve cover
- 1 Ea. 197591 Front crankshaft
- 1 Ea. 521371 Oil pump body cover
- 1 Ea. 532733 Carburetor base (1955-1958)
- OR 2 Ea. 1549319 Carburetor base (1959-1960)
- 1 Ea. 196693 Manifold
- 1 Ea. 510131 (1561173) Distributor
- 1 Ea. 534123 Oil pump suction
- 1 Ea. 534597 Water pump
- 1 Ea. 680291 Pipe flange
- 1 Set 1554698 Rear main
- 1 Set 1561429 Oil pan
- 1 Set 800389

Valve Grind Gasket Set (Includes the following)

- 1 Ea. 194194 Breather Tube
- 12 Ea. 194658 Thermostat (Upper)
- 1 Ea. 194660 Thermostat (Lower)
- 1 Ea. 534598 Cylinder head
- 1 Pr. 536554 Valve lifter cover
- & 4 ea. 156768 with screw gaskets
- 1 Ea. 1561168 Front plate
- 1 Ea. 1561172 Front cover

*LATE 1960 V-8 With rear main seal

Total of all parts listed if purchased separately.....\$306.80

801273* Special Kit Price.....\$275.00/set

Kit includes:

- 1 Ea. 167156 Crankshaft washer, front
- 1 Ea. 192125 Oil pressure relief
- 1 Ea. 440613 Carburetor base (4BBL)
- 1 Ea. 527224 Oil pump
- 1 Ea. 533010 Distributor
- 1 Ea. 535697 Oil Filler tube
- 1 Ea. 537354 Fuel pump
- 1 Set 802255

Valve Grind Gasket Set

(Includes the following)

- 1 Ea. 510550 Breather tube
- 3 Ea. 527240 Water pump manifold, upper
- 1 Ea. 527246 Water pump
- 1 Ea. 527284 Thermostat
- 2 Ea. 527856 Water pump manifold, lower
- 1 Pr. 530266 Intake manifold
- 16 Ea. 536264 Valve stem
- 1 Pr. 1561165X Rocker cover
- Includes (8) 530858 grommets
- 1 Set 801246 Exhaust manifold
- 2 ea. 1545072 (Included) Cylinder head
- OR 535982 Add \$35.00 for thicker Cylinder head gaskets

- 1 Ea. 1540006 Carburetor base (2BBL)
- 1 Ea. 1552264 Oil pan plug
- 1 Ea. 1559366 Rear main
- 1 Ea. 1561166 Front cover
- 1 Set 1561169 Valve Lifter Cover (Valley Cover)
- 1 Set 1561465 Oil pan set
- 3 Ea. 156768 Valve lifter cover screw

1961-EARLY 62 V-8 w/rear main seal

Same as above except replace Valve grind set

802255 with 800391

Total of all parts listed if purchased separately.....\$307.00

801274 Special Kit Price.....\$275.00/set

1961-64 6-CYL. With rear main seal

Total of all parts listed if purchased separately.....\$284.75

800382 Special Kit Price.....\$255.00/set

Kit includes:

- 1 Ea. 192125 Oil pressure relief
- 1 Ea. 197591 Crankshaft front
- 2 Ea. 530858 Grommet
- 1 Ea. 534123 Oil pump suction
- 1 Ea. 534597 Water pump
- 1 Ea. 537354 Fuel pump
- 1 Ea. 680291 Pipe flange
- 1 Set 800388

Valve Grind Gasket Set (Includes the following)

- 1 Ea. 194194 PCV valve adapter (1961-63) (Breather Tube)
- 12 Ea. 536264 Valve stem
- 1 Ea. 1550816 Thermostat
- 1 Ea. 1551869 Intake and Exhaust Manifold
- 1 Ea. 1693440 Cylinder head
- 1 Ea. 1561167 Rocker cover
- 1 Pr. 536554 Valve lifter cover
- & 4 ea. 156768 with screw gaskets

- 1 Ea. 1551403 Manifold divider
- 1 Ea. 1543376 Oil pump
- 2 Ea. 1549319 Carburetor base
- 1 Ea. 1552264 Oil pan plug
- 1 Ea. 1554698 Rear main
- 1 Ea. 1555103 Oil filter base (for 1963-64 only)
- 1 Ea. 1561168 Front plate
- 1 Ea. 1561172 Front cover
- 1 Ea. 1561173 Distributor
- 1 Set 1561429 Oil pan

*1962-64 (FULL FLOW) V-8

With rear main seal

Total of all parts listed if purchased separately.....\$309.00

801275* Special Kit Price.....\$275.00/set

Kit includes:

- 1 Ea. 167156 Crankshaft washer, front
- 1 Ea. 192125 Oil pressure relief
- 1 Ea. 440613 Carburetor base (4BBL) 1962 (WCFB) OR 1963-64 - (AFB)
- 1 Ea. 1557002 1963-64 - (AFB)
- 1 Ea. 527224 Oil pump
- 1 Ea. 533010 Distributor
- 1 Ea. 535697 Oil Filler tube (block off plate)
- 1 Ea. 537354 Fuel pump
- 1 Set 800391

Valve Grind Gasket Set (Includes the following)

- 1 Ea. 510550 Breather tube
- 3 Ea. 527240 Water pump manifold, upper
- 1 Ea. 527246 Water pump
- 1 Ea. 1550816 Thermostat
- 2 Ea. 527856 Water pump manifold, lower
- 1 Pr. 530266 Intake manifold
- 16 Ea. 536264 Valve stem
- 1 Pr. 1561165X Rocker cover
- Includes (4) 530858 grommets

- 1 Set 801246 Exhaust manifold
- 2 ea. 1545072 (Included) Cylinder head
- OR 535982 Add \$35.00 for thicker Cylinder head gaskets

- 1 Ea. 1540006 Carburetor base (2BBL)
- 1 Ea. 1552264 Oil pan plug
- 1 Ea. 1555103 Oil filter base
- 1 Ea. 1559366 Rear main
- 1 Ea. 1561166 Front cover
- 1 Ea. 1561169 Valve Lifter Cover (Valley Cover)
- 1 Set 1561465 Oil pan set
- 3 Ea. 156768 Valve lifter cover screw

ENGINE & ENGINE BLOCKS

- 1548985** Cylinder block with fitted pistons. 1959-60 170 cubic inch engine. **\$700.00 ea.**
- 1564868** Cylinder block. 1965-66 6-cylinder cars with .194 cubic inch engine. Includes pistons. **\$500.00 ea.**
- 1565702** Cylinder block. 1966 6-cylinder cars with .230 cubic inch engine. **\$650.00 ea.**

ENGINE FILLER BLOCK

- 527123** Front filler block. 1951-64 V-8 & 1963-64 Avanti. **\$53.00 ea.**



- 535996** 1955-64 6-cylinder Champion. **\$35.00 ea.**

- 529342** Right or left front, on block. 1951-52 Commander. **\$12.00 ea.**
- 530213** Left front, on frame. 1951-52 Champion. **\$24.00 ea.**
- 532404** Bracket, front engine mount to block. 1953-64 V-8, all models including Avanti. **\$15.00 ea.**



- 532398** Right front, on frame. 1953-54 Champion sedan. **\$20.00 ea.**
- 532399** Left front, on frame. 1953-58 Champion sedan. **\$20.00 ea.**
- 532400** Right front, on frame. 1953-58 V-8 sedan. Pictured above. **\$20.00 ea.**
- 532401** Left front, on frame. 1951-58 V-8. Sedan & wagon. Pictured above. **\$24.00 ea.**
- 536202** Right front, on frame. 1955-60 6-cylinder sedan. **\$20.00 ea.**



HIGH TEMPERATURE ENGINE ENAMEL

NOTE: This high quality enamel is mixed to match the original colors used by the factory when your car was new. Comes in 12 oz. Aerosol can, ready to spray.



- 800254** Green. 1954 & earlier. **\$14.65 can**
- 800255** Blue. 1955. **\$14.65 can**
- 800256** Turquoise 1956-57. **\$14.65 can**
- 800257** Silver. 1958-61. **\$14.65 can**
- 800258** Yellow. 1962-65 valve covers. 1962-66 trans dip stick. **\$14.65 can**
- 800259** Orange. 1962-65 fan, oil cap & supercharger. **\$14.65 can**
- 800689** Black. 1962-66 car & truck & 1963-64 Avanti. **\$14.60 can**
- 801922** Reduced sheen black enamel for radiators and other engine parts without a high gloss finish. **\$14.65 can**
- 801926** Reddish orange. 1961 valve covers. **\$14.65 can**
- 802463** Red, 1956 Golden Hawk. **\$14.65 can**

Note: We're sorry but due to air freight restrictions we cannot ship paint anywhere overseas or by airmail.

ENGINE ENAMEL QUART



- 800810** Green. 1954 & Earlier. **\$99.95 qt.**
- 800811** Blue. 1955. **\$99.95 qt.**
- 800812** Turquoise. 1956-57. **\$99.95 qt.**

ENGINE TO FRAME BRACKETS

- 1547208** Left front, on frame. 1959-64 6-cylinder, Lark. **\$20.00 ea.**



- 1550462** Right front, on frame. 1961-64 6-cylinder. **\$20.00 ea.**

- 1551242** Right front, on block. 1961-62 6-cylinder. **\$20.00 ea.**



- 1563588** bracket, right front engine support. 1965-66 6-cylinder car with standard transmission. **\$5.00 ea.**

- 1563589** bracket, left front engine support. 1965-66 6-cylinder car with standard transmission. **\$5.00 ea.**

- 532402** Right front, on block. 1953-54 Champion. **\$18.00 ea.**
- 532403** Left front, on block. 1953-54 Champion. **\$18.00 ea.**
- 536223** Right front, on frame. 1953-60 6-cylinder C & K. **\$20.00 ea.**



- 1563714-5** Engine to frame brackets for 1965-66 models. Can be used on earlier model sedans except C & K & Avanti to convert to Chevrolet engine. **\$187.50 pr.**

- 1563745** bracket, rear engine support. 1965-66 6-cylinder car with standard transmission. **\$6.00 ea.**

- 1563804** bracket, rear engine support. 1965-66 6-cylinder car with overdrive. **\$22.00 ea.**

- 1686126** Rear trans. Support for automatic transmission. 2E7 & 2E12 after 683979 & 3E & 4E 2, 7, 12, 13. **\$99.95 ea.**

- 1692223** Bracket, rear automatic transmission support. Truck: 5E-8E. Champ only. **\$99.95 ea.**



- 801830** Front bracket, Chevy V-8 to C & K. 1953-64. **\$150.00 ea.**



MAJOR REBUILD KITS FOR 1939-63 Champion 6-Cyl.

Kit includes:

- Complete gasket kit
- Cam bearings. Standard
- Camshaft timing gear 1939-54 Aluminum or 1955-64 fiber
- Main bearings — choice of: 1939-54 std., .001, .010, .020 (.030 .060 at extra cost) 1955-62 CRN/Partial Flow std., .001, .002, .010 (.020 or .030 at extra cost) 1963-64 Full Flow std., .010 (.020 or .030 at extra cost)
- Rod bearings — choice of: 1939-64 std., .002, .005, .010, .020, .030, .040 .060 not included in 801021X1
- Rods (w/Babbit Bearings) 1939-40 Champion head w/casting #194777

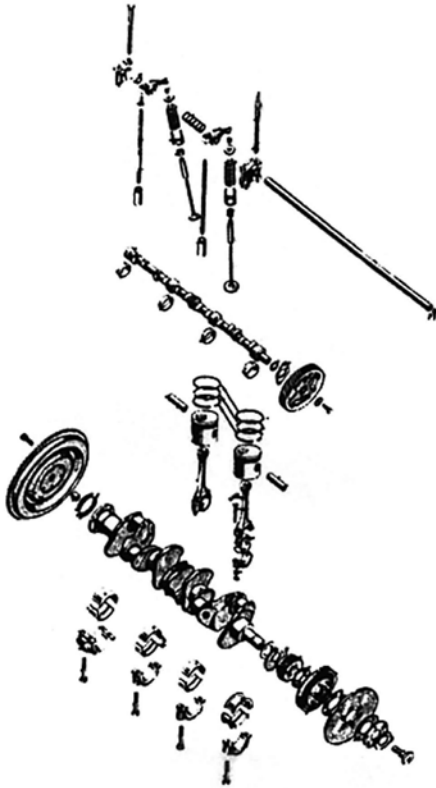

1939-47 CHAMPION 6-cylinder

For car already equipped with insert type rod bearings. Excludes oil pump kit.

Total of all parts listed if purchased separately\$2,265.75
Special Kit Price\$2,150.00
 —15% quantity discount. See page 6 \$322.50
801021X3R Your cost\$1,827.50 ea.

1939-40 CHAMPION 6-cylinder

w/cylinder head having casting #194777
 Excludes oil pump kit.

Total of all parts listed if purchased separately\$2,741.45
Special Kit Price\$2,600.00
 —15% quantity discount. See page 6 \$390.00
801021X1R Your cost\$2,210.00 ea.

- Rods to convert Babbit bearing engines to insert-type. 1939-46 Champion head w/casting #199697
- Oil pump kit only (1939-60) with 1½" gears
- Oil pump kit, complete (1961-63) with 1½" gears
- Oil pressure relief valve
- Oil pressure relief valve spring & washer
- Pistons — choice of: std., +.020, +.030, +.040 or +.060
- Piston rings — choice of: std., +.020, +.030, +.040 or +.060
- Crankshaft timing gear
- Crankshaft damper cushions (1942-64 only)
- 6 exhaust valves
- 6 intake valves

1939-46 CHAMPION 6-cylinder

with cylinder head having casting #199697
 Excludes oil pump kit..

Total of all parts listed if purchased separately\$2,383.50
Special Kit Price\$2,260.00
 —15% quantity discount. See page 6..... \$339.00
801021X2R Your cost\$1,921.00 ea.

1948-54 CHAMPION 6-cylinder

Total of all parts listed if purchased separately\$2,530.45
Special Kit Price\$2,400.00
 —15% quantity discount. See page 6..... \$360.00
801021R Your cost\$2,040.00 ea.

1955-58 CHAMPION 6-cylinder

Total of all parts listed if purchased separately\$2,450.60
Special Kit Price\$2,325.00
 —15% quantity discount. See page 6 \$348.75
801022R Your cost\$1,976.25 ea.

1959-60 LARK & HAWK 6-cylinder

Total of all parts listed if purchased separately\$2,330.30
Special Kit Price\$2,210.00
 —15% quantity discount. See page 6 \$331.50
801023R Your cost\$1,878.50 ea.

1961-63 OHV 6-cylinder

Total of all parts listed if purchased separately\$2,564.60
Special Kit Price\$2,435.00
 —15% quantity discount. See page 6 \$365.25
801024R Your cost\$2,069.75 ea.

- 12 valve guides
- 6 exhaust valve seats
- 6 intake valve seats
- 12 valve springs
- 6 freeze plugs
- 1 camshaft plug
- 2 rocker arm end plugs (1961-63 only) not included in 801021X1, X2 or X3
- 12 valve lifters (1961-63 only) not included in 801021X1, X2 or X3
- 2 cans aerosol engine enamel
- 2 silicone gasket sealer (tube)
- 1 lock plate
- 801354 heat riser kit. 1939-60
- 801355 heat riser kit. 1961-64

MINOR REBUILD KITS

Kit includes:

- Complete gasket kit
- Main bearings — choice of: 1939-54 std., .001, .010, .020 .030 (.060 at extra cost) 1955-62 CRN/Partial Flow std., .001, .002, .010 (.020 or .030 at extra cost) 1963-64 Full Flow std., .010 (.020 or .030 at extra cost)
- Rod bearings — choice of: 1939-64 std., .001, .002, .005, .010, .020, .030, .040 .060
- Cam bearings std.
- Piston rings (Cast iron) — choice of: std., +.020, +.030, +.040, +.060 (Except 1964)
- Timing gear
- Oil pump kit with 1½" gears
- Oil pressure relief valve, spring & washer
- 1 can aerosol engine enamel
- 1 silicone gasket sealer (tube)

1939-54 CHAMPION

Excludes oil pump kit.

Total of all parts listed if purchased separately\$1,178.50
Special Kit Price\$1,115.00
 —10% quantity discount. See page 6 \$111.50
801025R Your cost\$1,003.50 ea.

1955-58 CHAMPION & 1959-60 LARK & HAWK

Total of all parts listed if purchased separately\$1,107.40
Special Kit Price\$1,050.00
 —10% quantity discount. See page 6 \$105.00
801026R Your cost\$945.00 ea.

1961-64 OHV

Total of all parts listed if purchased separately\$1,022.85
Special Kit Price\$970.00
 —10% quantity discount. See page 6 \$97.00
801027R Your cost\$873.00 ea.

NOTE: When ordering specify year and model of car, bearing size, piston & ring size & paint color. No substitutions or deletions. Chrome rings available at extra cost.

MAJOR REBUILD KITS FOR 1955-64 V-8 259, 289

Kit includes:

- Complete gasket kit
- Main bearings choice of: std., -.010, -.020, .030
- Rod bearings choice of: std., -.001, -.002, -.010, -.020, .030
- Cam bearings std.
- Pistons — choice of most sizes
- Piston rings (Cast iron) — choice of: std., +.020, +.030, +.040, +.060
- Oil pump kit except for rebuild kit 801016

1955 259 V-8

Total of all parts listed if purchased separately\$2,311.80
Special Kit Price\$2,195.00
 —15% quantity discount. See page 6 \$329.25
801016R Your cost.....\$1,865.75 ea.

1956-64 259 V-8

Total of all parts listed if purchased separately\$2,367.95
Special Kit Price \$2,245.00
 —15% quantity discount. See page 6 \$336.75
801017R Your cost..... \$1,908.25 ea.

1956-64 289 all V-8 except with jet thrust engine

Total of all parts listed if purchased separately\$2,347.95
Special Kit Price \$2,230.00
 —15% quantity discount. See page 6 \$334.50
801018R Your cost..... \$1,895.50 ea.

NOTE: When ordering specify year and model of car, bearing size, piston & ring size & paint color. No substitutions or deletions. Chrome rings are available at extra cost.

- Oil pressure relief valve, spring & washer
- 8 intake valve seats
- 8 exhaust valve guides
- 8 intake valve guides
- 16 valve springs
- 16 valve lifters
- 6 freeze plugs
- 1 camshaft plug
- 4 rocker arm end plugs
- 2 cans aerosol engine enamel

1963-64 AVANTI JET THRUST R-1

Total of all parts listed if purchased separately\$2,144.45
Special Kit Price \$2,035.00
 —15% quantity discount. See page 6 \$305.25
801076R Your cost.....\$1,729.75 ea.

- 2 silicone gasket sealer (tube)
- 1 lock plate
- Crankshaft timing gear except Avanti
- Camshaft timing gear (fiber) except Avanti
- Crankshaft damper cushions (pair) except Avanti
- 8 exhaust valves
- 8 intake valves
- 8 exhaust valve seats

NOTE: Timing gears not included for R1 and R2 engines.

1963-64 AVANTI JET THRUST R-2

Total of all parts listed if purchased separately\$2,216.20
Special Kit Price\$2,105.00
 —15% quantity discount. See page 6\$315.75
801081R Your cost.....\$1,789.25 ea.

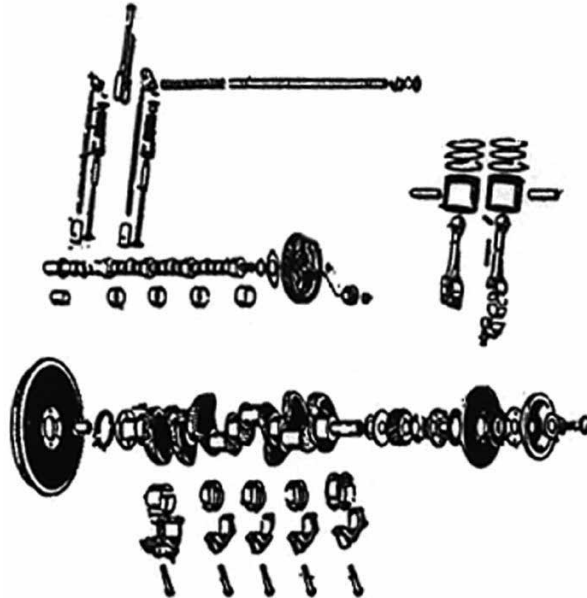

MINOR REBUILD KITS FOR 1951-64 V-8 224, 232, 259, 289

Kit includes:

- Complete gasket kit
- Main bearings — choice of: std., -.010, -.020, .030
- Rod bearings — choice of: std., -.010, -.020, .010, .020, .030
- Cam bearings std.

1951-54 V-8, 232

Total of all parts listed if purchased separately\$1,132.00
Special Kit Price\$1,075.00
 —10% quantity discount. See page 6\$107.50
801019R Your cost.....\$967.50 ea.

- Piston rings (Cast iron) — choice of: std. +.020, +.030, +.040, +.060
- Timing gear all except Avanti & jet thrust
- Oil pump kit
- Oil pressure relief valve & washer

1955-64 V-8, 224, 259, 289

Total of all parts listed if purchased separately\$1,166.40
Special Kit Price\$1,105.00
 —10% quantity discount. See page 6\$110.50
801020R Your cost.....\$994.50 ea.

- Oil pressure relief valve spring
- 1 can aerosol engine enamel
- 1 silicone gasket sealer (tube)

1963-64 AVANTI Jet thrust R-1 or R-2

Total of all parts listed if purchased separately\$1,010.05
Special Kit Price \$955.00
 —10% quantity discount. See page 6\$95.50
801091R Your cost..... \$859.50 ea.

NOTE : When ordering specify year and model of car, bearing size, piston & ring size & paint color. No substitutions or deletions. Chrome rings available at extra cost.



Tom & Kathy Rinehimer's 1934 Dictator from Berwick, Pennsylvania.

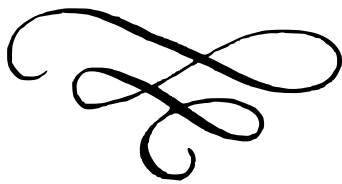

FUEL SECTION GLOSSARY

Gas Filler Parts	172-173
Pumps, Sending Units	173
Pump Related Parts	173
Carburetors & Related Parts.....	174-176
Air Cleaners & Related Parts.....	177
Supercharger Related Parts	178
Gas Pedals & Related Parts	178
Throttle & Clutch Related Parts	179
Gas Tanks	180

GAS FILLER PARTS

261419 Filler lid bumper. 1940-64 car, all models with external gas lid except Avanti. Takes 2 **\$2.00 ea.**



272078 Filler neck grommet. 1939-46 Champion, 1954-59 station wagon and all model trucks 1947 & later Exact to match original **\$15.00 ea.**

285120-1 Springs, gas lid. 1947-55 all models, 1956 station wagon, and 1956-64 Hawk **\$15.50 pr.**



286647 Filler neck grommet. 1947-54 car all models **\$15.00 ea.**

289526 Door, gas lid. 1950-52 Champion & Commander... **\$40.00 ea.**



531581 Gas filler hose. 1950-57 car, all models. 1958 sedans **\$24.00 ea.**



652750 Floorboard filler pipe grommet. Truck: 1949-64 all models **\$37.85 ea.**

681425 Filler to tank hose. Truck: 1949-64 all models... **\$35.00 ea.**



681426 Gas Filler pipe. Truck: 1949-64 all models. Pictured above **\$45.00 ea.**



1314750 Hinge, gas filler door. 1956-58 sedan **\$18.50 ea.**



1314754-5 Springs, gas lid. 1956-58 sedan. Takes 1 of each... **\$18.00 pr.**

1323180 Gas door. 1957 Packard. **\$35.00 ea.**
1326485 Gas door. 1958 sedan. **\$35.00 ea.**
1326488 Gas door. 1958 Packard sedan. **\$35.00 ea.**
1331524 Gas door. 1959-61 Lark sedan. **\$30.00 ea.**

1342577 Trunk pipe filler grommet. 1962-66 Lark..... **\$8.00 ea.**



1350604 Spring, gas lid. 1963-89 Avanti **\$6.00 ea.**



1350997 Gas lid rubber bumper. 1963-85 Avanti. **\$3.50 ea.**



1544586 Gas filler hose. 1958-64 Hawk, 1959-66 station wagon..... **\$22.00 ea.**



1547343 Pictured below. Gas filler pipe. 1959-60 station wagon **\$36.00 ea.**



1550703 Gas filler pipe. 1961-62 station wagon **\$36.00 ea.**

1554436 Gas filler hose. 1962-66 Lark, 1963-73 Avanti **\$15.50 ea.**



1554622 Gas filler pipe. 1962-63 Lark except station wagon. **\$36.00 ea.**



1554674 Filler tube gasket. 1962-66 Lark and 1963-89 Avanti except convertible..... **\$3.50 ea.**



1561053 Gas filler pipe. 1964-66 Lark except station wagon. **\$36.00 ea.**



FUEL FILLER PROTECTORS

AC-2408 1953-55 sedan and station wagon without extended side mouldings. Mounting hardware included. NOS **\$59.95 ea.**



AC-2703 1953-58 sedan and station wagon with extended side mouldings except 1957 President. Mounting hardware included. NOS. **\$59.95 ea.**



AC-2704 Gas filler guard for all 1953-64 C & K models includes Hawk. Adds a little sparkle to the left side of your car while also protecting its finish. No drilling required. Includes mounting hardware. **\$45.00 ea.**

801924 Mounting hardware kit for all fuel filler protectors. Includes 2 grommets, 2 screws, and 2 retainer clips **\$6.50 ea.**



REPLACEMENT GAS CAPS

523821 Vented. 1928-58 all models **\$9.50 ea.**

800945 Vented. 1959-61 Lark, 1959-64 Hawk Truck: 1953-64 all models **\$14.55 ea.**

800946 Vented. 1951-61 Lark station wagon. 1962-66 Lark all models **\$18.00 ea.**

800948 Locking & vented. 1928-61 all models and 1962-64 Hawk. Truck: most models..... **\$27.30 ea.**

800949 Locking & vented. 1959-61 station wagon 1962-66 Lark, all models..... **\$31.50 ea.**

1558091 Replacement gas cap for 1963-64 Avanti **\$29.50 ea.**

GAS CAPS - NOS

636799 M-series truck (less cab)..... **\$45.00 ea.**

1547457 1959-62 station wagon **\$38.50 ea.**

1554431 1962-66 Sedan..... **\$38.50 ea.**

1559401 1963-66 station wagon... **\$38.50 ea.**

GAS CAP ORNAMENTS

1547360 1959-66 Wagon..... **\$8.50 ea.**





525548

289710

1555964

FUEL SENDING UNITS & RELATED PART

- 289710** Fuel sending unit cover. Covers hole in trunk floor. 1947-66 most models. \$15.00 ea.
- 525548** 1947-55 car, 6-volt. Includes mounting gasket. \$85.00 ea.
- 664967** 1941-48 M-Series truck. 6-volt. Includes mounting gasket. \$125.00 ea.
- 674041** 1949-1953 with 2 terminals on tank unit & 3 on dash unit, like original with modern float. \$125.00 ea.
- 680018** Late 1949-1955 truck. 6-volt. Includes mounting gasket. \$125.00 ea.
- 802421** Fuel sending unit mount screw set. \$3.95/kit
- 1540262** 1956-57 Sedan \$125.00 ea.
- 1540263** 1956-57 Hawk & Wagon except 57 Golden Hawk \$125.00 ea.
- 1542895** 1957 Golden Hawk \$125.00 ea.
- 1549575** 1958-66 car, all models except Avanti. 12-volt. Includes mounting gasket. \$90.00 ea.
- 1555957** 1963-85 Avanti. 1963-1964 bus models 28 & 40. 12-volt. (Includes mounting gasket).... \$90.00 ea.
- 1555964** Extra mounting gasket, all models. 16-volt. Pictured top right pg. 169 \$2.50 ea.
- 1685600** Truck 1956-64, all models. 12-volt. (Includes mounting gasket)..... \$85.00 ea.

FUEL PUMP MOUNTING GASKETS

- 197389** All cars and trucks 1934 - 54. Also 6-cylinder truck 1955 - 64. \$2.00 ea.
- 537354** 1955-64 6-cylinder and V-8 car. Truck: 1955-64 V-8. Pictured \$1.50 ea.
- 1564250** 1965-66 V-8 \$1.50 ea.



FUEL PUMP FLEXIBLE LINE "BRAIDED"

- 178804** 1932 Rockne "75", 1933 Model 56 1934-36 Dictator. \$15.50 ea.



FUEL PUMP FLEXIBLE HOSES

- 189888** 1937-57 most models. \$21.50 ea.
- 535284** 1955-57 C & K except '57 Golden Hawk. \$23.30 ea.
- 1542892** 1957 Golden Hawk \$20.00 ea.
- 1543516** 1957 Packard. \$20.00 ea.

FUEL PUMP FOR 6-CYLINDER ENGINES

Includes: Mounting Gasket

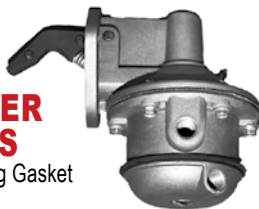

- 536435** Pictured. 1933-50 Champion \$175.00 ex.
- 679936** 1941-60 Commander 6-cylinder. Single action. Rebuilt/exchange. \$150.00 ex.
- 681107** 1939-54 Champion. Truck: M5, M15, M15A & 2R-2E 5, 10, 15 & 3E-4E 1, 5, 10. \$175.00 ex.
- 1549267** 1959-64 car, all model. \$175.00 ex.
- 1549342** Truck: Late 1959-64 6-cylinder Champion 1, 5, 10. \$175.00 ex.
- NOTE: New or rebuilt dual action pumps available for 1948-50 cars & 1949-53 trucks. Call for availability & price.**

FUEL PUMP FOR V-8 ENGINES

Includes Mounting Gasket

- 535701** 1951-54 car, all models. Truck: 3R 28, 38. Exchange. \$210.00 Ex.
- 1557015** 1963-64 Lark, Hawk & Avanti with R-2 jet thrust engine. \$282.60 ea.
- 1557213** 1963-64 Lark, Hawk & Avanti with R-1 jet thrust engine. \$252.85 ea.
- 1562992** 1955-64 car all models except Avanti jet thrust. Truck: E-8E 2, 7, 12, 13, 28, 38, 40. Master. \$175.00 ex.

FUEL PUMP REBUILD KITS



- 523349** 1936-37 Dictator, 1938-47 Commander, M16 & M17 trucks all, and 1949 2R16 & 17 (all w/ single action AC pump having flange #'s 2227 or 9067) \$75.00/kit
- 524390** 1948-50 Champion and Commander Truck; 2 R All. Dual action \$103.90/kit
- 531918** 1951-54 V-8 & trucks 1950-60 2R-5E 3, 6, 11, 14, 16, and 17. Single action "AC" pump having flange #9415 and flange number 4142. \$75.00/kit
- 536953** Fuel pump "diaphragm only". 1955-58 V-8 with original carter pump model M22115. \$36.00 ea.
- 1542877** 1957-58 Golden Hawk, 1957 Packard with supercharger. \$75.00/kit
- 1542878** 1955-60 all V-8 models & 1961-62 Hawk, all models with glass bowl. \$75.00/kit
- 1553024** 1961-62 Lark & 1963-64 all V-8 models with metal bowl. \$75.00/kit
- 1558925** 1963-64 Lark, Hawk & Avanti with jet thrust R-1 or R-2 engine. \$75.00/kit
- 1564651** 1965 - 66 6-cylinder. \$22.50/kit
- 1564778** Diaphragm kit, 1965 - 66 6-cylinder .. \$10.00/kit
- 6484039** 1956 Golden Hawk \$75.00/kit

ELECTRIC FUEL PUMPS



- 800249** 6 volt. \$57.99 ea.
- 800250** 12 volt \$54.00 ea.

ELECTRIC FUEL PUMP SAFETY SWITCH

- 802041** Safety switch. Use with electric fuel pump to prevent gas flow if line is broken. \$26.40 ea.



Using an Electric Pump?

SEAL THE OPENING WITH THESE PLATES

- 801852** Cover plate. Use with electric fuel pump for all 6-cylinder and V-8 applications except 1965-66 V-8 \$15.50 ea.

FUEL PUMP HEAT SHIELDS

- 187748** 1938-60 Commander 6-cylinder. \$20.00 ea.
- 527874** 1947-54 Champion. Complete with mounting studs. \$32.00 ea.



FUEL FILTERS & GASKETS

- AC-2987** Inline fuel filter kit with "Studebaker Packard" logo fits most models car & truck including Avanti. Includes hoses and clamps. \$8.00 ea.
- 535702** Filter in fuel pump bowl. 1954 Commander. \$16.00 ea.
- 1549273** Fuel pump filter bowl. 1959-64 6-cylinder. \$8.60 ea.
- 1552876** Fuel pump bowl. 1962-64 7E-8E 7, 12, 13, 28, 40 \$9.50 ea.



PIPES, FUEL PUMP TO CARBURETOR

- 535695** 1955-58 V-8 w/o a/c. 2-BBL..... **\$25.00 ea.**
- 536381** 1955-58 V-8 w/o a/c. Truck: 3E-4E 2, 7, 12, 13, 28, 38, 40. 5E 13, 28, 40. 4-BBL..... **\$25.00 ea.**
- 536466** 1955-58 Champion..... **\$15.00 ea.**
- 537528** 1955-57 V-8 with air conditioning. 2-BBL..... **\$25.00 ea.**
- 537529** 1955-57 V-8 with air conditioning. 4-BBL..... **\$25.00 ea.**
- 678131** Truck: 2R 6, 11, 14, 16, 17 with governor..... **\$18.00 ea.**
- 1545998** 1959 Hawk V-8. 4-BBL. with power steering..... **\$25.00 ea.**
- 1547592** 1959-60 V-8. Truck: 5E 7, 12. 4-BBL..... **\$25.00 ea.**
- 1548464** 1959 Hawk V-8. 2-BBL. with Saginaw power steering..... **\$25.00 ea.**
- 1551174** 1961-62 6-cylinder..... **\$15.00 ea.**
- 1551240** 1961-62 Lark V-8. Truck: 6E-7E 7, 12, 13, 28, 40. 2-BBL..... **\$25.00 ea.**
- 1551334** 1961-62 Lark V-8. Truck: 6E-7E 7, 12, 13, 28, 40. 4-BBL..... **\$25.00 ea.**
- 1558369** Truck: 8E 7, 12, 13, 28, 40. 4-BBL..... **\$25.00 ea.**
- 1558570** Truck: 8E 5, 10 without governor..... **\$15.00 ea.**
- 1564749** 1965 V-8..... **\$25.00 ea.**
- 1564750** 1965-66 6-cylinder..... **\$25.00 ea.**
- 1565650** 1966 V-8..... **\$25.00 ea.**

CARBURETOR TO AIR CLEANER ADAPTERS & SEALS

- 473070** Carburetor/air cleaner seal. All 1955-62 WCFB and 1963-64 AFB 4-BBL incl. Avanti..... **\$3.00 ea.**
- 1549361P** Carburetor to air cleaner adapter. 1959-60 V-8 w/dry air cleaner. Pictured..... **\$22.50 ea.**
- 1551977** Carburetor to air cleaner adapter. 1961 V-8 w/dry air cleaner..... **\$22.50 ea.**
- 1564550** Carburetor/air cleaner seal 1965-66 V-8..... **\$2.00 ea.**

STRAIGHT 8 CARBURETOR REPAIR KITS



- 518619** 1935-37 car, Stromberg EE-1: 6-10, 6-50, 6-52, 6-63..... **\$83.85/kit**
- 518671** 1938-42 car, Stromberg AAO-161: 6-70, 6-85, 6-97..... **\$88.05/kit**
- 800396** 1940 President, Carter WDO: 409S..... **\$78.25/kit**

NOTE: These new production repair kits contain all necessary gaskets including the base gasket. Most also contain the accelerator pump, float needle and seat, cotter pins, ball check valves and other necessary parts to rebuild each specific carburetor. Some factory originals major rebuild kits available, please inquire.

V-8 4-BBL CARBURETOR PARTS & REPAIR KITS



- 800204** Accelerator pump seal. 1963-64 Avanti R-2 (not included with 1558469 kit)..... **\$31.50 ea.**
- 537697** 1955-60 car, WCFB 2214S, 2219S, 2230S, 2574S, 2575S..... **\$80.50/kit**
- 1552538** 1960-62 car, WCFB 2829S, 2830S, 3165S, 3166S, 3419S, 3420S, 3422S, 3423S. Truck E-7E 2, 7, 13, 28, 38, 40..... **\$80.50/kit**
- 1558469** 1963-64 car & Avanti R-1 & R-2, Carter AFB 3506S, 3540S, 3589S, 3726S. Truck: 7E-8E 7, 12, 13, 28, 40..... **\$64.75/kit**

CARBURETOR INLET NEEDLE AND SEAT

- 518626** 1951-52 Commander..... **\$24.00 ea.**

V-8 2-BBL CARBURETOR REPAIR KITS

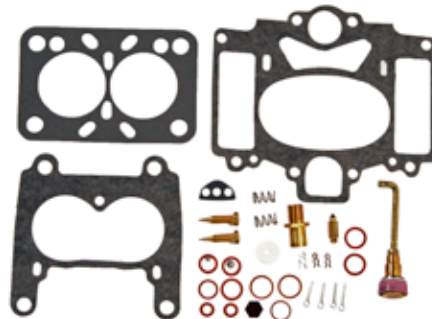

- 531842** 1951-52 car, Stromberg AAUVB-26, 6-107, 6-111. Pictured above..... **\$77.55/kit**
- 1543054** 1957-58 car with supercharger, Stromberg WW: 6-121A, B, 6-122..... **\$69.85/kit**
- 1552791** 1953-62 car, Stromberg WW. Truck: E-2E 7, 12 & 3E-8E 7, 12, 13, 28, 38, 40..... **\$57.30/kit**
- 1562329** 1963-64 car, Stromberg WW: 6 130, 132. Truck: 8E 7, 12, 13, 28, 40..... **\$90.00/kit**
- 1564614** 1965-66 car, Rochester GC: 7024101, 110, 7025088..... **\$39.10/kit**

6-CYLINDER 1 BBL CARBURETOR REPAIR KITS

- 518227** 1935-37 Dictator & Coupe Express. Stromberg EX-23: 6-9, 6-49, 6-62..... **\$79.50/kit**
- 518250** 1938-40 Stromberg BXO-26: 6-69, 6-84..... **\$90.55/kit**
- 518557** 1939-52 Stromberg BXV, BXOV-26: 6-90, 6-91, 6-98, 6-100, 6-101, 6-104, 6-109. Truck: M16 & M17..... **\$56.00/kit**
- 518760** 1937 Dictator & Coupe Express. Carter W-1:371S..... **\$67.05/kit**
- 518824** 1939-40 Champion. Carter WO: 444S, 453S, 468S..... **\$88.20/kit**
- 518840** 1941-42 Champion. Carter WA1: 496S. Truck: M5 & M15..... **\$81.80/kit**
- 1543433** 1946-58 Champion. Carter WE: 532S, 661S, 715S, 989SA, 2108S, 2190S, 24157, 6275, 5A, 2417S. Truck: M5, M15, M15A..... **\$68.45/kit**
- 1550400** 1959 Lark or Hawk. Carter AS: 2876S. Truck: 4E 1, 5..... **\$89.40/kit**
- 1550822** 1960-62 Lark or Hawk. Carter AS: 3046S, 2934S, 3159S-3162S, 3186S, 3370S-3373S. Truck: 7E 5,10..... **\$95.00/kit**



- 1562643** 1963-64 Lark. Carter RBS: 3538S, 3539S, 3653S, 3654S. Truck: 8E 5, 10. (Pictured above)..... **\$103.65/kit**
- 1564580** 1965-66 Lark. Rochester B, BV: 7025087, 105, 108, 7026085..... **\$20.50/kit**
- 1564594** Zip kit for all 1965-66 cars with 194 6-cylinder..... **\$35.00/kit**
- 1689678** 1949-59 all models with Carter BBR-1. Truck: 2R-2E 5, 6, 10, 11, 14, 17 & 3E 1, 3, 5, 6, 10, 11, 14, 16, 17..... **\$58.60/kit**

CARBURETORS Rebuilt

802188 Most Models Available We must have old re-buildable core first.

Call (317) 462-3124 for Availability & Pricing

CARBURETOR NOS



1564967 1965-66
194 6-cylinder.....
.....**\$225.00 ea.**

CARBURETOR GASKET SETS

NOTE: These NOS Gasket Kits contain all of the gaskets for each of the listed carburetors. No other hardware is included.

- 517944** Carter WA-1 496-S **\$22.00/set**
- 517953** Stromberg BXV, BXOV-26: 6-90, 6-91, 6-98, 6-100, 6-101, 6-104, 6-109 and Carter WO: 444S, 453S, 468S **\$22.00/set**
- 517959** Stromberg AAV-26 used on 1941-42 President..... **\$28.00/set**
- 518249** Stromberg EX-23: 6-9, 6-49, 6-62 **\$22.00/set**
- 518251** Stromberg BXO-26: 6-69, 6-84 **\$22.00/set**
- 518627** Stromberg AAO-161..... **\$15.00/set**
- 518841** 1940 President 8 with Carter WDO 409-S..... **\$28.00/set**
- 525969** Carter WE 532S, 661S, 715S, 627SA... .. **\$15.00/set**
- 533632** 1953-56 Commander with Stromberg WW..... **\$18.00/set**
- 533918** 1953-58 Champion with Carter WE. **\$18.00/set**
- 674595** M16 & M17 with BBR1 model 514-S..... **\$25.00/set**
- 678536** 1955-59 trucks, 1957-58 Scotsman car & truck, with Carter BBR-1..... **\$25.00/set**
- 678540** 2R & 3R trucks with BBR1 model 633-S..... **\$25.00/set**
- 680772** 1951-52 Commander, Stromberg AAUVB-26 **\$15.00/set**
- 1540645** 1956-58 Commander with Stromberg WW. 6-117 **\$15.00/set**
- 1543277** Late 1958, all 1959, & 1960 Commander with Carter WCFB 2574S, 2575S..... **\$15.00/set**
- 1543382** 1955 - Early 1958 V-8 with Carter WCFB..... **\$15.00/set**
- 1550308** 1959-61 V-8 with Stromberg WW 6-123, 123A, 123B, 125B..... **\$15.00/set**
- 1550399** 1959-60 6-cylinder with Carter AS. 2876-5, 2934-5, 3046-5 **\$15.00/set**
- 1551318** 1960 6-cylinder with Carter AS-2934SA. **\$15.00/set**
- 1555292** 1962-63 V-8 with Stromberg WW 6-127 thru 6-130..... **\$15.00/set**
- 1560329** 1963-64 6-cylinder with Carter RBS .. **\$15.00/set**

- 1562633** AFB model 3726-S..... **\$28.00/set**
- 1563876** 1964 V-8 with Stromberg 132 **\$15.00/set**
- 1564574** Rochester 7024101, 7024110, 7025088 **\$15.00/set**
- 1564577** Rochester 7025105, 7025108, 7025087, 7025608. **\$15.00/set**
- 1689309** Stromberg WW 6-119, 120. 1957-59 V-8 truck **\$15.00/set**

NOS/FACTORY CARBURETOR KITS

Note: These NOS Kits contain all gaskets and seals, jets, plugs, needle and seat, and many other items.



- 518204** Major repair kit for Stromberg model AAV-26 used on 1941-42 Presidents. **\$125.00/kit**
- 518824X1** 1939-40 Champion w/444-S or 453-S Carter..... **\$95.00/kit**
- 527443** 1937 Dictator, 1938 & 1950 Commander with WE Carter. **\$60.00/kit**
- 533631** 1953-55 V-8 with 6-112, 6-113 or 6-115 Stromberg 2-barrel. **\$60.00/kit**
- 535813** Repair kit for 1954 Land Cruiser with Stromberg model 6-113..... **\$85.00/kit**
- 674596** Truck: 1937-42 includes M16 & M17 with 428-S or 514-S Carter **\$70.00/kit**
- 678541** Repair kit for Carter Model BBR-1 (633-S). Used on 2R & 3R 5, 10, & 15. **\$95.00/kit**
- 680772** Repair kit for 1954 Truck model 3R28 and 38 with AAUVB-2 Stromberg carburetor..... **\$75.00/kit**
- 685044** Repair kit for 1955-58 trucks w/Champion 6-cyl. engine. Carter BBR-1 models 2125-S, 2724-S, 3764-S, & 2808-S **\$95.00/kit**
- 1541923** 1947-50 Commander Truck: M16 & M17 with BXOV-26 Stromberg **\$95.00/kit**
- 1541924** Major repair kit for 1951-52 Commander & Landcruiser using Stromberg models 6-07 & 6-11 **\$95.00/kit**
- 1541925** Repair kit for 1955-58 V-8 car & trucks with Stromberg model 6-116 carburetor **\$85.00/kit**
- 1541927** 1956-58 V-8 with 6-117A or B Stromberg 2-barrel..... **\$70.00/kit**
- 1549748** Zip kit for 1955-58 trucks with Champion 6-cyl. engine. Carter BBR-1 models 2125-S, 2724-S, 3764-S, & 2808-S **\$75.00/kit**
- 1550300** Repair kit for Carter AS model 2934-S & 3046-S. 1960 car with 6-cylinder & 1959-60 Champ truck **\$120.00/kit**
- 1550400X1** 1959 Lark 6, Truck: Champ 6-cylinder with 2876S Carter **\$82.50/kit**
- 1550678** Repair kit for Carter AS models 2934-SA & 3046-SA, some 1959-60 cars w/6-cyl. & 1960 Champ truck with 6-cyl..... **\$120.00/kit**
- 1550823** Zip kit for Carter AS model 2934-S & 3046-S. 1960 car with 6-cylinder & 1959-60 Champ truck **\$95.00/kit**
- 1552212** Repair kit for 1957-58 Supercharged cars with Stromberg models 6-121C & 6-122A **\$85.00/kit**
- 1552221** Major repair kit for 1961 V-8 with Stromberg model 6-125, 6-125-B, and 6-126..... **\$85.00/kit**
- 1552421** 1961 Lark, Truck: Champ 6-cylinder with 3159S or 3160S Carter..... **\$75.00/kit**
- 1552535** 1961 6-cyl. w/3161S or 3162S Carter. Excludes metering rods & jets **\$70.00/kit**
- 1553878** Minor repair kit for 1959-60 V8's with Stromberg model 6-123, and 1960-62 5E-7E trucks with Stromberg model 6-124 **\$65.00/kit**
- 1555290** Zip kit for 1962 6-cylinder cars & trucks using the Carter models 3370-S, 3371-S, 3372-S, & 3373-S **\$95.00/kit**
- 1555563** Major repair kit for 1962 V8's with Stromberg model 6-127 **\$85.00/kit**
- 1557540** Zip kit for Carter AS models 2934-SA, 3046-SA, 3159-S, & 3160-S, 3186-S, 1961-64 6-cylinder taxi, some 1959-60 cars w/6-cyl. & 1960 Champ truck w/6-cyl **\$120.00/kit**
- 1558083** Minor repair kit for 1962 V8's with Stromberg models 6-128A & 6-129A.... **\$65.00/kit**
- 1558084** Major repair kit for 1962 V8's with Stromberg models 6-128A and 6-129A **\$85.00/kit**
- 1558334** Major repair kit for 1963-Early 64 cars and trucks with Stromberg models 6-130 and 6-131..... **\$75.00/kit**
- 1558335** Minor repair kit for 1963-Early 64 cars and trucks with Stromberg models 6-130 and 6-131.....
- 1560178** Zip kit for 1963-64 6-cyl. w/Carter RBS models 3538-S & 3539-S..... **\$75.00/kit**
- 1560180** Repair kit for 1963 AFB Model 3540-S..... **\$85.00/kit**
- 1560830** Repair kit for 1963-64 6-cyl. w/Carter RBS models 3538-S & 3539-S..... **\$95.00/kit**
- 1562634** Zip kit for 1964 AFB model 3726-S ... **\$65.00/kit**
- 1563877** Minor repair kit for Late 1964 cars and trucks with Stromberg models 6-131 and 6-132..... **\$65.00/kit**
- 1565682** 1966 230 6-cyl. Pictured .. **\$65.00/kit**
- 1688219** Major overhaul kit for 1954 Truck model 3R28 and 38 with AAUVB-2 Stromberg carburetor **\$95.00/kit**
- 1690575** Major repair kit for - 1955-58 trucks w/Champion 6-cyl. engine. Carter BBR-1 models 2125-S, 2724-S, 3764-S, & 2808-S..... **\$95.00/kit**

CARBURETOR IMPROVEMENT KITS

1550997 Fuel delivery kit. 1960 6-cylinder with 2934S or 3064S Carter. Includes pump plunger, step-up rods, inlet needle, pump link and top cover gasket.....**\$25.00/kit**



1550998 1960 6-cyl. w/2934S or 3046S Carter. Includes thermostat housing & spring, choke plate vacuum piston & small related parts. Pictured left.....**\$30.00/kit**



CARBURETOR BASE GASKETS

440613 1956 Golden Hawk & 1955-62 all models w/WCFB 4-BBL carburetor**\$3.90 ea.**

522070 1941-52 Champion, 1947-50 Commander.....**\$3.50 ea.**

532733 1953-58 Champion.....**\$4.00 ea.**

684059 1951-56 V-8 w/2-BBL carburetor.....**\$4.00 ea.**

1540006 1957-64 V-8 WW 2-BBL carburetor 1/8" thick.....**\$2.50 ea.**

1549319 1959-64 6-cylinder.....**\$2.50 ea.**

1557002 1963-64 w/AFB 4-BBL carburetor including 1963-64 Avanti 1/16" thick.....**\$2.50 ea.**

1557002X1 Same as 1557002 except extra thick. 1963-64 Avanti and 1963-64 Lark/Hawk with jet thrust engine.....**\$14.55 ea.**

1564512 1965-66 V-8.....**\$2.50 ea.**

1564513 1965-66 6 cyl. cars.....**\$3.00 ea.**

CARBURETOR COMPONENTS

187069 Inlet needle & seat, for carburetors that use repair kit # 518227.....**\$34.95 ea.**

197346 Accelerator pump plunger for carburetors that use repair kit # 518824.....**\$18.00 ea.**

198910 Accelerator pump, for Carter WAI-410-S carburetor.....**\$18.00 ea.**

517127 Accelerator pump plunger for carburetors that use repair kit # 518557.....**\$15.50 ea.**

517945 Accelerator pump plunger for carburetors that use repair kit # 518840.....**\$18.00 ea.**

518174 Inlet needle & seat for carburetors that use repair kit # 518557.....**\$18.00 ea.**

518252 Inlet needle & seat for carburetors that use repair kit # 518250.....**\$19.95 ea.**

518254 Accelerator pump, for carburetors that use repair kit # 518227 & 518250.....**\$19.95 ea.**

518626 Inlet needle & seat for 1938-40 President 8 with Stromberg AAO-161, & 1941-42 Presidents with Stromberg AAV-26 and 1954 Truck model 3R28 and 38 with AAUVP-2 Stromberg carburetor.....**\$28.00 ea.**

518740 Accelerator pump for carburetors that use repair kit # 518760.....**\$19.95 ea.**

Studebaker Gift Certificates

Always a Great Idea!



Studebaker INTL.
111 Aiken St., Hope IN 47246
(317) 462-3124

Gift Certificate

Good for the purchases to the value of \$ _____

TO: _____

FROM: _____

X _____
This certificate is invalid and void without an Authorized Signature

**Available in any Amount!
No Expiration Date!**

519691 Accelerator pump plunger for Carter WE 532-S, 661-S, 715-S, & 627-SA**\$18.00 ea.**

535467 Accelerator pump plunger for Carter WE 2108-S, 2190-S, and 2417-S.....**\$22.00 ea.**

662896 Inlet needle & seat. Fits M16 & M17 trucks. 1957-58 Scotsman car & trucks. 1956 2E trucks. with Carter BBR-1.....**\$15.00 ea.**

637407 Needle & seat for carburetors that use repair kit # 518760.....**\$22.00 ea.**

680279 Inlet needle & seat. Fits 1949-55 2R-E 16 & 17 trucks with Carter BBR-1 models 606-SA or 606-SB.....**\$18.00 ea.**

680748 Accelerator pump plunger for 1954 Truck model 3R28 and 38 with AAUVP-2 Stromberg carburetor.....**\$18.00 ea.**

1543038 Accelerator pump plunger for 1957-58 supercharged cars with Stromberg models 6-121C, 6-122A, 6-122, 6-121A, and 6-121B.....**\$17.00 ea.**

1543053 Inlet needle & seat for 1957-58 supercharged cars with Stromberg models 6-121C, 6-122A, 6-122, 6-121A, and 6-121B**\$18.00 ea.**

1546828 Accelerator pump plunger for BBR1 model 2808-S, some 1958 Scotsman car and trucks.....**\$18.00 ea.**

1548593 Needle & seat for Carter AS model 2876-S.....**\$25.00 ea.**

1548599 Accelerator piston for Carter AS model 2876-S.....**\$20.00 ea.**

1550412 Inlet needle & seat for Carter AS models 2934-S, 2934-SA, 3046-S, & 3046-SA....**\$18.00 ea.**

1550743 Inlet needle & seat for Carter AS models 3159-S, 3160-S, 3161-S, & 3162-S.....**\$20.00 ea.**

1550744 A, Accelerator pump plunger for Carter AS models 2934-S, 2934-SA, 3046-S, 3046-SA, 3159-S, 3160-S, 3161-S, & 3162-S.....**\$25.00 ea.**

1555571 Accelerator pump plunger for 1962 6-cyl. cars & trucks using the Carter models 3370-S, 3371-S, 3372-S, & 3373-S.....**\$25.00 ea.**

1555720 Inlet needle & seat for Carter WAI-410-S, WE 532-S, and WE 989-S, 2108-S, 2190-S, and 2417-S carburetor.....**\$15.00 ea.**

AIR CLEANERS



- 530576** Dry. 1951-52 Commander. Does not include elbow **\$130.00 ea.**
- 531933** Cover only. Wet. 1953-54 Champion and Commander **\$78.00 ea.**
- 533022** Dry. 1953-54 Champion **\$176.00 ea.**
- 533023** Dry. 1953-54 Commander. Pictured above **\$160.00 ea.**
- 533096** Wet. 1953-54 Commander sedan. Pictured, below **\$109.00 ea.**



- 533103** Wet. 1953-54 Champion ... **\$120.00 ea.**
- 533332** Cover only. Dry. 1953-54 Champion and Commander **\$78.00 ea.**

- 536617X3** Wet. 1955-58 V-8 sedan with 4 barrel carburetor. **\$155.00 ea.**
- 536774** Wet. Filter element for 536317-8 air cleaner. **\$66.00 ea.**
- 682024** Wet. Truck: 3R, 28, 38 **\$131.50 ea.**
- 684041** Wet. Truck: E - 2E 5, 10, 15, 4E 3, 6, 11, 14, 16. **\$105.00 ea.**
- 684121** Wet. 1955-58 V-8 truck with 4 barrel carburetor. **\$160.00 ea.**
- 1540238** Dry. 1955-58 Champion 6-cylinder. **\$120.00 ea.**
- 1540239** Wet. 1955-58 Champion. Pictured below **\$85.00 ea.**
- 1547566** Wet. 1959-60 6-cyl. car. **\$105.00 ea.**

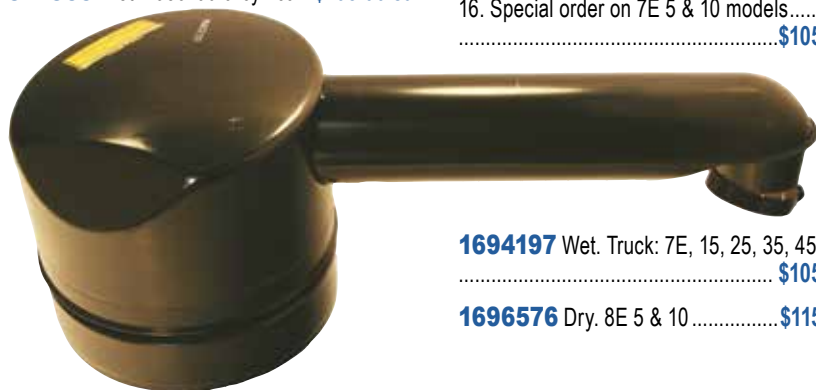

- 1550381** Wet. 1960 V-8 Hawk w/2 barrel carburetor. **\$95.00 ea.**
- 1551338** Wet. 1961-62 6-cyl. & 1963-64 6-cylinder taxi's. **\$109.00 ea.**
- 1551513** Wet. 1961 V-8 2-BBL **\$109.00 ea.**
- 1551979** Dry. 1961 with 2 barrel V-8. **\$155.00 ea.**
- 1554685** Wet. 1962-64 V-8 2-BBL without positive crankcase ventilation. **\$109.00 ea.**
- 1558366** Wet. 1963-64 6-cyl. **\$100.00 ea.**

- 1563903** Dry. 1965-66 6-cylinder without sealed crankshaft ventilation. **\$120.00 ea.**
- 1563904** Dry. 1965-66 6-cylinder with sealed crankshaft. **\$120.00 ea.**
- 1563906** Dry. 1965-66 V-8 with sealed crankshaft. **\$120.00 ea.**
- 1565285** Wet. 1965-66 6-cylinder with sealed crankshaft. **\$100.00 ea.**
- 1690922** Wet. Truck: 4E-6E 2, 7, 12 and 4E-8E 13, 28, and 40 all with 4-barrel WCFB (except vehicles equipped with F-30 oil filter). **\$105.00 ea.**
- 1692671** Wet. 7E 5 & 10 w/governor. **\$115.00 ea.**
- 1692672** Wet. Truck: 5E 5, 6, 10, 11, 14, and 16. Special order on 7E 5 & 10 models. **\$105.00 ea.**

- 1694197** Wet. Truck: 7E, 15, 25, 35, 45 **\$105.00 ea.**
- 1696576** Dry. 8E 5 & 10 **\$115.00 ea.**

AIR FILTER ELEMENTS



- 1547813** 1953-62 6-cyl. car, 1953-60 V-8 car w/2-BBL carb Truck: E-7,12,3E-6E 1, 2, 5, 6, 7, 10, 11, 12, 14, 16 & 7E 5,10. Pictured **\$14.00 ea.**
- 1552494** 1961-64 V-8 car 2 or 4-BBL 1957-58 with supercharger. Requires spacer. Truck: 6E-8E 7, 12 **\$18.50 ea.**
- 1555053** 1962-63 6-cylinder car, 1963-64 Lark, Hawk & Avanti with jet thrust R-2 engine Truck: 8E 5, 10. Takes 2 **\$26.30 ea.**
- 1558962** 1963-64 Lark, Hawk & Avanti with jet thrust R-1 engine. **\$21.10 ea.**
- 1561842** Dry. 1964-66 Lark 6-cyl. **\$9.00 ea.**
- 1564132** 1965-66 V-8 **\$9.00 ea.**
- 1691062** Trucks 4E-6E models 2, 7, 12, 13, 28, & 40. 7E-8E models 13, 28, & 40. All with air cleaner number 1690922. **\$22.00 ea.**

AIR CLEANER SUPPORTS

521604

- Bracket, wet air cleaner support 1947-49 Commander. **\$8.00 ea.**
- 1561724** Air cleaner clamp with Fram 1561841 or 1563120 air cleaners. 1964 6-cyl. **\$10.25 ea.**



R-1 AIR CLEANERS



- 801844** Black base only, for 1562826 Air Cleaner 4 1/8" **\$49.00 ea.**
- 801845** Chrome appearing base only, for 1562826X Air Cleaner. 5 1/8" **\$39.99 ea.**

AIR CLEANER CHROME WINGNUT

- 3-015** Standard on 1963-64 models with Avanti jet thrust engine and a nice addition on other models. Chrome washer included. **\$5.00/set**



GAS PEDAL PUSH RODS

- 514024** 1941-42 Commanders & Presidents .. **\$18.50 ea.**
- 519052** 1947-52 Champions with standard or Overdrive **\$14.00 ea.**
- 520101** 1950 Champions with automatic, 1947-50 Commanders **\$19.00 ea.**
- 530310** 1951-52 Commander w/standard trans. **\$16.50 ea.**
- 530525** 1951-52 Commander w/auto. trans. **\$19.50 ea.**
- 533475** 1953-54 C&K with 6 cylinder and type A pedal **\$11.00 ea.**
- 534801** All 1954-58 V8 Sedan models (LHC)... **\$23.00 ea.**
- 535127** 1954-55 C-K Champions w/push on gas pedal, 1956-58 6-cyl Hawks w/standard trans **\$19.00 ea.**
- 535128** 1954-55 Champion sedans, 1956-58 Champion sedan w/standard trans, 1956 Champion w/ AD **\$19.00 ea.**
- 666465** M16 & M17 trucks **\$35.00 ea.**
- 674069** 1949-54 trucks with Champion 6 cylinder & standard trans. without OD. **\$19.00 ea.**
- 674854** 1949-60 trucks w/Commander 6 cylinder & standard trans. without OD. **\$35.00 ea.**
- 1685204** Gas pedal push rod, 7E-8E 28 & 40 (for models with long steering gear). **\$18.50 ea.**
- 1694369** Gas pedal push rod, 7E-8E 40 **\$18.50 ea.**

SUPERCHARGER RELATED PARTS

G451228 Hose clamp, supercharger to carburetor air box, 1957-58. Takes 2. NOS.... **\$8.00 ea.**

41X32 Washer, idler arm (large) All models with supercharger including Avanti..... **\$1.50 ea.**

800241 Air cleaner lid seal. 1963-64 Lark, Hawk & 1964 Avanti with jet thrust R-2 engine. **\$6.50 ea.**

800307 Emblem 1957-58 Golden Hawk. Fits on top of McCulloch supercharger..... **\$19.00 ea.**

801652 Emblem 1957 Packard & 1958 Packard Hawk. Fits on top of McCulloch supercharger..... **\$19.00 ea.**

1542337 Elbow. Supercharger to air cleaner. 1957-58 Golden Hawk, 1957 Packard, 1963-64 R-2 Lark & Hawk..... **\$42.00 ea.**

1542353 Air box seal, 1957-58 Golden Hawk, 1957 Packard & 1958 Packard Hawk. Halves seal together to keep air pressure in. **\$12.50 ea.**

1542362 Idler arm bushing (smaller, takes 2) All models with supercharger including Avanti..... **\$5.50 ea.**

1542363 Idler arm bushing, larger, takes 2. All models with supercharger including Avanti..... **\$3.50 ea.**

1542364 Snap ring, larger, takes 2. All with supercharger including Avanti..... **\$1.50 ea.**

1542365 Snap ring, smaller, takes 2. All with supercharger including Avanti..... **\$1.50 ea.**

1542691 Kick down switch. 1957-58 models with s/c **\$45.00 ea.**

1542765 Flapper valve, 1957-58 Golden Hawk, 1957 Packard, 1958 Packard Hawk, 1963-64 Lark, Hawk, Avanti with jet thrust R-2 engine. Fits inside carburetor air box or bonnet..... **\$15.00 ea.**

1542801 Flexible hose supercharger to air cleaner. 1957-58 Golden Hawk. 1957 Packard, 1958 Packard Hawk **\$25.00 ea.**

1542802 Hose to supercharger carburetor. 1957-58 All 1963-64 Lark & Hawk..... **\$20.00 ea.**

1542834 Dashpot on carburetor w/auto. trans. 1957-58 Golden Hawk, 1957 Packard, 1958 Packard Hawk with supercharger. Plus 1959-64 with 2-barrel carburetors ... **\$35.00 ea.**

1542908 Pulley with hub. 1957-58 Golden Hawk, 1957 Packard, 1958 Packard Hawk with supercharger. ... **\$135.00 ea.**

1542912 Pulley with bushing. 1957-58 with supercharger. **\$107.50 ea.**

1542916 Bearing, driven pulley. 1957-58 w/supercharger **\$65.00 ea.**

1542920 Piston, air cylinder. 1957-58 Golden Hawk, 1957 Packard, 1958 Packard Hawk with supercharger **\$75.00 ea.**

1542921 Spring, air cylinder piston. 1957-58 with supercharger **\$30.00 ea.**

1542937 Seal, s/c input shaft. All models with s/c, including Avanti **\$12.00 ea.**

1542952 Driver. All models with supercharger. **\$20.00 ea.**

1542953 Shaft with Bushing, input. 1957-58 with supercharger **\$125.00 ea.**

1542958 Spring Race Load Coil. 1957-58 with supercharger **\$22.00 ea.**

1542973 Retainer idler arm spring. 1957-58 Golden Hawk, 1957 Packard, 1958 Packard Hawk with supercharger. **\$6.90 ea.**

1552401 Bolt, idler pulley. All models with power steering, including Avanti with supercharger. **\$20.50 ea.**

1552569 Bearing, idler pulley. All models with s/c, including Avanti. **\$11.25 ea.**

1556854 Support, supercharger mounting bracket. 1963-64 Avanti..... **\$16.00 ea.**

1556953 Carburetor air bonnet. Chrome. 1963-64 Avanti with R-2 supercharged engine **\$234.00 ea.**

1557350 Hose, supercharger to air cleaner. 1963-64 Avanti..... **\$45.00 ea.**

1557956 Supercharger driven pulley, 1963 Lark & Hawk..... **\$75.00**

1557957 Supercharger mounting bracket, 1963-64 Lark & Hawk..... **\$45.00**

1557751 Hose, supercharger to carburetor 1963-64 Avanti. **\$45.00 ea.**

1558328 Chrome clamp, supercharger to carburetor hose. 1963 Lark, Hawk & Avanti. **\$12.50 ea.**



1558629 Flexible hose. supercharger to air cleaner. 1963-64 Lark R-2. **\$25.00 ea.**
1558705 Supercharger idler pulley spacer, 1963-64 Lark & Hawk **\$12.00 ea.**
1558732 Flexible hose, supercharger to air cleaner. 1963-64 Hawk..... **\$32.50 ea.**

Note: For supercharger belts see page 58.

ACCELERATOR (GAS) PEDAL COVER & WEAR PADS

AC-2029 Accelerator pedal cover and wear pad with "S" logo. Popular Studebaker accessory for most models 1947-65. Prolongs life of accelerator pedal and protects floor covering where the most wear occurs. Fabricated of heavy black rubber. Slides on easily **\$26.50 ea.**

GAS PEDALS

Type (A)  Type (B) 

519957 1947-1950 cars with standard transmission **\$39.50 ea.**

527135 1950 car with auto trans, 1951-55 car with type A fastener, all except C & K. **\$30.00 ea.**

532800 1953-58 C & K models with type A fastener. **\$26.50 ea.**

535116 1954-58 Sedans with type B fastener .. **\$35.00 ea.**

535117 With type B fastener, 1953-64 C & K models, includes Hawk. 1959 Lark, all models **\$25.25 ea.**

680280 Late 2R-1961 C-cab truck. **\$32.50 ea.**

1552623 1961-64 6 cylinder car, 1962-64 V-8 Lark, 1961-64 T-cab truck **\$35.00 ea.**

1560745 1963-85 Avanti. Pictured left. **\$29.95 ea.**

1563463 1965 mounted under carpet **\$32.00 ea.**

1565001 1965 mounted on top of carpet..... **\$29.00 ea.**

1565170 1966 with suspended pedal. **\$16.00 ea.**

CHOKE COVER ACCELERATOR PUMP PLUNGER

801839 For Carter WE Carburetor. 1947-48 Champions with 532-S or 661-S model carburetor. One each 519711 and 519691..... **\$24.00 set**



PIPE, AUTO CHOKE

531379 Pipe, auto choke to manifold. 1951-52 V-8..... **\$15.00 ea.**

TUBE, AUTO CHOKE HEATER

532420 1952 V-8..... **\$24.00 ea.**
532571 1953-58 V-8..... **\$24.00 ea.**

CHOKE HOUSING & THERMOSTATS

530555 Carter WE 1949-54 Champion..... **\$38.25 ea.**
531946 Stromberg AAUVB, 1951-52 Commander..... **\$41.50 ea.**
533621 Stromberg WW. 1953-58 V-8..... **\$42.00 ea.**



CHOKE COVER SEAL

537187 Choke cover seal. WCFB or AFB 4-BBL..... **\$1.00 ea.**



THROTTLE CHECKS

533820 1953-58 V-8 with 2-BBL carburetor & automatic transmission..... **\$42.00 ea.**



1557729 1963-64 Lark & Hawk. with Carter AFB 4-BBL carburetor & without jet thrust engine..... **\$35.00 ea.**



THROTTLE BOOT

513536X1 1939-66 car & truck all models & 1963-85 Avanti. Keeps hot air out of interior compartment..... **\$7.00 ea.**



675388 Gas pedal push rod grommet, 1949-64 C-cab trucks with RHC..... **\$4.00 ea.**

THROTTLE BELLCRANK SWIVEL

195716 On linkage below gas pedal. 1947-52 all models, 1941-66 most models & 1963-85 Avanti..... **\$11.50 ea.**



THROTTLE RETURN SPRINGS & BRACKETS

195999 Accelerator pullback. 1947-50 Commander with standard trans. & Cars 1939-46 All..... **\$8.00 ea.**

520443 Spring, throttle return. 1947-64 6-cyl (Includes 51 Champion & Commander with standard transmission)..... **\$9.50 ea.**

527423 Spring, throttle. 1950 Commander with automatic transmission..... **\$8.00 ea.**

529300 Upper accelerator return spring. 1950-58 Champion with automatic transmission..... **\$9.60 ea.**

529301 Lower throttle spring. 1950 Champion and 1951-52 Commander with automatic transmission. 1953-55 all, and 1956 Golden Hawk..... **\$6.50 ea.**

533585 Throttle spring. 1955-57 Commander & President with air conditioning & having a 2-barrel carburetor. ... **\$7.20 ea.**

534230 Spring, carburetor actuating. 1953 Commander..... **\$9.60 ea.**

534766 Cross shaft to carburetor. 1954 - 55 Commander..... **\$6.50 ea.**

536440 Spring, throttle return. 1955 Commander with standard and overdrive Trans & having a 2-barrel carburetor..... **\$8.00 ea.**

536596 Bracket, throttle spring to manifold valve cover. 1956-64 car, truck with 4BBL & 1963-64 Avanti..... **\$5.00 ea.**

537355 Spring, throttle return. 1955-64 V-8 with 4-BBL including 1963-64 Avanti..... **\$4.95 ea.**

537356 Bell crank to carburetor spring. 1955 Commander & Late 1955 President w/4-BBL... **\$7.50 ea.**

1549684 Bracket, throttle spring to manifold. 1953-60 most models, 1963-64 Avanti. Trucks: E-2E..... **\$6.50 ea.**

1550646 Spring, throttle. Carburetor linkage to water outlet. 1951-64 V-8, most models except Avanti..... **\$4.95 ea.**

1559671 Spring, throttle. 1951-64 V-8 most models except Avanti. Carburetor linkage to valve cover..... **\$4.95 ea.**

1563902 Spring, throttle return. 1965-66 6-cylinder..... **\$7.50 ea.**

1564772 Spring, throttle return. 1965 V-8 without suspended pedal..... **\$7.50 ea.**

1565175 Spring, throttle return. 1965 & early 1966 V-8 with suspended pedal..... **\$9.50 ea.**

PCV VALVES

1561327 1963-64 6-cylinder..... **\$25.00 ea.**
1562731 1963-64 Avanti..... **\$36.00 ea.**
1564710 1965-66 6-cylinder..... **\$20.00 ea.**
1564729 1965-66 V-8..... **\$20.00 ea.**



Swap Meets

Unfortunately, we can only attend a select few.

Visit our online "Events" page for current meet information and order deadlines.

Remember - delivery of your prepaid order during a meet is FREE!

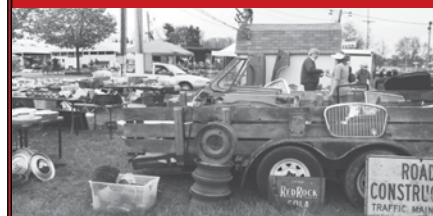

www.studebaker-intl.com

GAS TANKS

1547266 Gas tank. Lark except wagons, 1959-1961.....**\$465.00 ea.**

1554315 Gas tank. Wagon, 1959-1966.
.....**\$465.00 ea.**

1554320 Gas tank. Lark, 1962-1966.
.....**\$450.00 ea.**



1544597 Fits all 1958-64 Hawks and 1953-64 C & K. You can plug the pick up tube to use on 1956-57 Hawks. Remove the threaded end on your fuel line to use on 1953-55 C & K models.
..... **\$450.00 ea.**



681768
1949-1964
C-cab & Champ
trucks w/tank mounted
under cab. Includes 1 gasket,
5 phillip screws, 5 washAers, and 1
elbow. **\$465.00 ea.**

G181637 Bolt to front bracket for 681768 tank
..... **\$2.00 ea.**

G444860 Drain plug for 681768 tank **\$.55 ea.**



525610 1950-1952 **\$450.00 ea.**
531968 1953-1958 Sedan except wagons **\$450.00 ea.**



1555947 1963-1988
except convertible Avanti gas tank
(aluminum) **\$826.00 ea.**



1697340 1963-1964
Zip Van. **\$310.00 ea.**

Swap Meets

Unfortunately, we can only attend a select few.
Visit our online "Events" page for current meet information and order deadlines.
Remember - delivery of your prepaid order during a meet is FREE!

www.studebaker-intl.com



59 Lark 6 Auto Owned By Jim And Elaine Hoglund Of Rochester, Indiana



COOLING SECTION GLOSSARY

Radiators & Related Parts 182-183

Water Pumps & Related Parts 184

Fans & Related Parts 184-185

Thermostats & Related Parts..... 185

Heater Cores & Related Parts 186-187

Heater & Defroster Related Parts 187-189

Air Conditioning Related Parts..... 190

BRASS FREEZE PLUGS



127366 1-3/16" disc.
1934-42 all models except
Champion & 1947-50
Commander. Truck: M16, 17
& 2R-5E 3, 6, 11, 14, 16, 17.
Takes 1.**\$2.75 ea.**

801353 1-1/2" Self locking type.
Easily installed in difficult to get at
places**\$7.70 ea.**

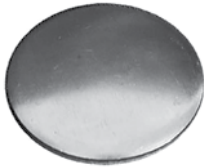

1539038 1-1/2" disc.
1939-60 Champion. Takes
1. 1934-60 Commander
6-cyl. Takes 6. 1951-early
62 V-8. Takes 6. Truck:
M5 10, 15 & 2R-6E 2, 7,
12, 13, 28, 38, 40. Also used on camshaft rear
bearing hole **\$3.00 ea.**

1550386 1-1/2" cup. Late 1962-64 car, 6-cyl.
Takes 1. 1962-64 V-8 including Avanti. Takes 6.
Truck: 6E 5, 10 & 7E-8E 5, 7, 10, 12, 13, 28, 40 ...
.....**\$3.75 ea.**

1550433 1-7/8" cup. 1939-64 Champion
6-cylinder. Truck: M5, 10, 15 & 2R-2E 5, 10, 15 &
3E-6E 1, 5, 10. Takes 3.**\$4.50 ea.**

1553644 Steel. 11/16" 1961-64 6-cyl. Head
Takes 6. Truck: 6E-8E 5,10.**\$1.80 ea.**

1563955 Steel. 1 5/7" 1965-66 6-cylinder &
V-8**\$1.00 ea.**

1563956 Steel. 2" 1965 - 66 6 -cylinder.
.....**\$1.00 ea.**

RADIATOR BAFFLE

1312475 Rubber seal,
above radiator. 1956-64
C & K. Steel staples
included.**\$22.75 ea.**

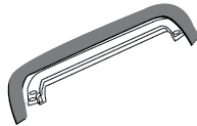

801930 Steel staples**\$2.25 set/20**

RADIATOR OVERFLOW KIT

800183 This
radiator overflow kit
was factory
equipment for many
years on Avanti
II's, and is a good
addition on all
other Studebakers
including Larks,
Hawks & trucks.
Includes bottle, cap,
bracket, radiator cap,
and flexible tube.
.....**\$36.75 ea.**



801858 Extra Cap,
radiator overflow bottle.**\$1.50 ea.**

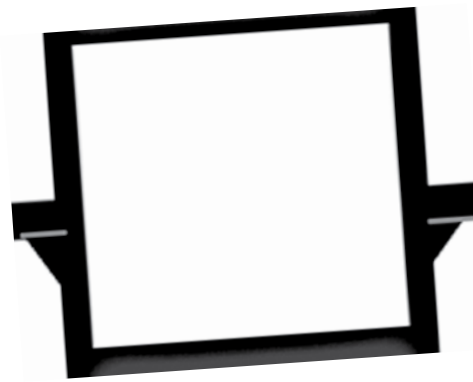

RADIATOR SUPPORTS

*Availability is extremely
limited on some NOS units.*

274527 1941-46 Champion **\$95.00 ea.**

284345 1947- early 48 Champion.. **\$95.00 ea.**

289247 Late 1948 Champion..... **\$95.00 ea.**

289640 1950 Champion. **\$95.00 ea.**

289580 1950 Commander. **\$95.00 ea.**

290486 1949 Champion **\$95.00 ea.**

296263 1951-52 all cars **\$95.00 ea.**

298385 1953-55 all sedan **\$95.00 ea.**

303446 1953-55 C & K **\$130.00 ea.**

1312069 1956-58 all except C & K **\$95.00 ea.**

1312081 1956-58 Hawks except 1958 Packard.
..... **\$160.00 ea.**

1327593 1958 Packard Hawk..... **\$160.00 ea.**

1331374 1959-60 Lark all except convertibles
..... **\$95.00 ea.**

1336875 1960 convertible. **\$120.00 ea.**

1338330 1961-64 convertible, 1962-64 Lark
& all 1963-66 sliding roof wagons except 65-66
6-cylinder. **\$120.00 ea.**

1338332 1961-64 Lark, all model except sliding
roof station wagon & convertible & 1965-66 V-8
except sliding roof station wagon..... **\$110.00 ea.**

1358717 1963-85 Avanti *Pictured*.....
..... **\$269.95 ea.**

1361025 1965-66 6-cylinder Lark station
wagon with sliding roof. **\$95.00 ea.**

1361026 1965-66 6-cylinder Lark, all models
except sliding roof station wagon..... **\$95.00 ea.**

1654125 1956-64 C-cab Truck most models
except the largest model for 1962 thru 1964. Call
for exact application coverage **\$140.00 ea.**

1655783 1962-64 Truck model 15 thru 45 with
the exception of model 40. **\$140.00 ea.**

1693608 1963-64 Postal Zip Van.. **\$95.00 ea.**

AVANTI SURGE TANK ELIMINATOR KIT



*Tired of leaks in your surge
tank? This kit offers an easy and
permanent fix that was standard
on later model Avanti.*

800480 Kit includes
cast iron water outlet,
hoses, clamps,
filler, overflow tank,
everything needed,
63-69
..... **\$165.00/kit**



COOLING SYSTEM CLEANER & NEUTRALIZER

802084 Studebaker-Packard "Cooling System
Cleaner & Neutralizer". This is a genuine item originally
manufactured for Studebaker & sold at their dealerships. It
is not a duplicate. Brightly colored can has cleaner on one
end and neutralizer on the other. Contents are usable or
makes a great display item **\$12.50 ea.**



MOLDED RADIATOR HOSES

UPPER 6-CYLINDER



- 128270** 1941-50 Champion. Truck: M5, M15, M15A..... **\$18.25 ea.**
- 191984** 1939-40 Commander & 1939-40 President 8, Truck: 1939-40 Coupe Express..... **\$22.90 ea.**
- 530601** 1951-52 Champion..... **\$18.50 ea.**
- 532430** 1953-55 Champion sedan... **\$24.00 ea.**
- 532431** 1953-55 Champion C & K... **\$24.75 ea.**
- 673969** Truck: 2R-2E: 5, 10, 15 & 3E 1, 5, 10..... **\$18.25 ea.**
- 1539058** 1956-58 Champion..... **\$19.00 ea.**
- 1544587** 1959-60 Lark & 5E5 truck. **\$22.00 ea.**
- 1544589** 1958-60 C & K..... **\$22.00 ea.**
- 1551327** 1961 Lark & 6E 5&10 trucks..... **\$18.00 ea.**
- 1554368** 1962-64 Hawk (export).... **\$22.00 ea.**
- 1554369** 1962-64 Lark. Truck: 7E-8E: 5, 10, ... **\$29.00 ea.**



- 156357** 1965-66 All..... **\$16.50 ea.**

LOWER 6-CYLINDER

- 522159** 1941-48 M5 & M15 truck..... **\$22.50 ea.**
- 521861** 1947-49 Commander..... **\$28.30 ea.**
- 522160** 1947-50 Champion..... **\$22.50 ea.**
- 524781** 1950 Commander..... **\$29.90 ea.**
- 530881** 1951-52 Champion..... **\$21.25 ea.**
- 533087** 1953-64 C & K, includes Hawk..... **\$33.75 ea.**
- 533092** 1953-55 Champion sedan... **\$24.75 ea.**
- 675736** 1941-48 M16 & M17 truck... **\$20.00 ea.**
- 801120** Truck: 2R-4E 1, 5, 10, 15. Replaces 673990 & 678660 & 673992..... **\$39.90 ea.**
- 1539108** 1956-58 Champion sedan **\$24.75 ea.**
- 1539364** 1956-64 Hawk..... **\$22.00 ea.**
- 1548583** 1959-60 Lark & 5E5 truck. **\$24.75 ea.**
- 1552785** 1961-64 Lark & 7E-8E 5&10 trucks ... **\$24.75 ea.**



- 1563627** 1965-66 All..... **\$22.00 ea.**



UPPER V-8

- 530560** 1951-52 Commander..... **\$27.60 ea.**
- 532174** 1953-55 Commander & President sedan. *Pictured*..... **\$22.00 ea.**
- 532454** 1953-55 Commander & President C & K..... **\$22.00 ea.**
- 1539059** 1956-57 Commander & President.... **\$21.35 ea.**
- 1539087** 1956 Golden Hawk..... **\$43.50 ea.**
- 1539157** 1956 Power & Sky Hawk. 1957 Silver Hawk..... **\$22.50 ea.**
- 1542335** 1957 Golden Hawk..... **\$22.50 ea.**
- 1543552** 1957 Packard..... **\$17.90 ea.**
- 1544588** 1958 Commander & President & 1959-60 Lark. Truck: 5E: 7, 12..... **\$22.00 ea.**
- 1544590** 1958-60 Hawk except 1958 Golden Hawk..... **\$23.65 ea.**
- 1550652** 1961-64 Lark. Truck: 6E-8E: 7, 12, ... **\$22.00 ea.**
- 1550980** 1961-64 Hawk..... **\$25.65 ea.**
- 1555934** 1963-64 Avanti..... **\$22.00 ea.**
- 1685683** 1956-64 C-cab trucks..... **\$29.00 ea.**
- 1700928** 1966-85 Avanti w/o surge tank or high output engine. Short..... **\$20.50 ea.**
- 1700929** 1966-85 Avanti w/o surge tank or high output engine. Long..... **\$33.55 ea.**

LOWER V-8



- 530131** 1951-52 Commander..... **\$25.10 ea.**
- 532385** 1953-55 Commander & President sedans..... **\$25.90 ea.**
- 532412** 1953-55 C & K..... **\$25.90 ea.**
- 800699** 1966-83 Avanti..... **\$27.75 ea.**
- 1539084** 1956 Golden Hawk..... **\$35.75 ea.**
- 1539109** 1956-60 Commander, President & Lark. Truck: 5E 7, 12..... **\$25.90 ea.**
- 1539129** 1956-60 Hawk..... **\$25.90 ea.**
- 1546378** 1961-64 Hawk..... **\$29.50 ea.**
- 1550654** 1961-64 Lark. Truck: 6E-8E: 7, 12.... **\$26.05 ea.**
- 1555929** 1963-64 Avanti..... **\$22.50 ea.**
- 1564983** 1965-66 Lark..... **\$16.90 ea.**
- 1685689** 1956-64 C-cab truck..... **\$47.00 ea.**

RADIATOR & HEATER HOSE WIRE CLAMPS

G111616 For 1-3/4" radiator hose, for upper radiator hose 1955-58 6-cylinder & V8 (1 per vehicle), various other uses..... **\$7.25 ea.**

G111622 For 2-1/8" radiator hose, for lower radiator hose 1951-64 V-8 (1 per vehicle), various other uses..... **\$2.75 ea.**

G272852 For 3/4" heater hose, 1959-64 and other various applications..... **\$1.00 ea.**

RADIATOR CAPS

199952 Non-pressure. 1941-51 car. Truck: 1941-54 Replacement..... **\$12.00 ea.**

531826 7PSI radiator cap 1952-54 car, all models. Truck: 1949-55 all models and 1956-58 Champion with 6-cylinder. 1" deep, excellent quality reproduction that looks just like the original..... **\$25.00 ea.**

536502 13 PSI radiator cap. All 1956-58, all 1955 6-cylinder and 1955 V-8 with 536464 or 536465 radiators. 3/4" deep. NOS. ... **\$22.00 ea.**

1551190 13 PSI. All 1955-66 car & 1963-85 Avanti. Truck: 1961-64. 3/4" deep. Replacement... **\$8.75 ea.**

1551190X 14 PSI radiator cap. All 1955-66 car, 1963-85 Avanti. Truck: 1961-64. 3/4" deep. Looks just like the original with S.M. Co. stamping. Zinc plated..... **\$25.15 ea.**

HEATER CONTROL PLATES

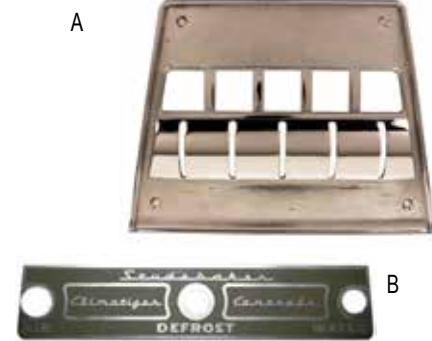

A. **1360025** 1964-85 Avanti. Chrome control lever plate only without walnut or aluminum overlay..... **\$65.00 ea.**

B. **677916P** Heater control nameplate. Truck: 2R-4E..... **\$14.50 ea.**

B. **1691696** Heater control nameplate. Truck: 7E & 8E..... **\$14.50 ea.**

NEW 6-CYLINDER WATER PUMPS

Gasket included - NO CORE CHARGE

- 519442** 1947-50 Commander. Truck: 1949-59 with Commander engine..... **\$189.75 Ex.****
- 682630** 1942-53 Champion. Truck: M5, late M15 and 1949-58 with Champion..... **\$131.35 ea.**
- 1563639** 1954-64 car, all models. Truck: 1959-60 with Champion engine and all 1961-64..... **\$131.35 ea.**

REBUILT 6-CYLINDER WATER PUMPS

GASKET INCLUDED



**EXCHANGEABLE ONLY

- 184098** 1935 Dictator..... **\$345.75 Ex.****
- 186711** 1936 Dictator..... **\$345.75 Ex.****
- 192258** 1937-42 Dictator, Commander & Coupe Express..... **\$375.00 Ex.****
- 199654** 1939-41 Champion. Truck: M5, early M15..... **\$131.25 Ex.****
- 534714** 1954-58 Champ..... **\$96.00 Ex.****
- 663286** Truck: 1941-48 M16-M17 with Commander engine..... **\$325.00 Ex.****
- 1692116** Truck: 1960 5E with Commander 6-cylinder 6, 11, 14, 16..... **\$131.25 Ex.****

Note: **Because of a shortage of cores, we must have your old re-buildable pump first before we can send out this pump.



NEW V-8 WATER PUMP

GASKETS INCLUDED
NO CORE CHARGE
**EXCHANGEABLE ONLY

- 527070** Late 1951-64 car, all models except Avanti. Truck: 1954-64..... **\$120.00 ea.**
- 527242** Early 1951 V-8. NOS..... **\$125.00 ea.**
- 1560395** 1963-64 Avanti. Not used on other R-Eng. cars. Pictured..... **\$131.25 ea.**
- 1564459** 1965-66 Lark..... **\$82.25 ea.**

NOTE: All rebuilt and new water pumps come with a new mounting gasket. To order gaskets separately see "ENGINE" section of this catalog.

REBUILT 8 CYLINDER WATER PUMP

**EXCHANGEABLE ONLY

- 458410** 1956 Golden Hawk..... **\$137.00 Ex.****
- 516502** 1938 - 40 President 8-cylinder..... **\$149.35 Ex.****

****Note: Because of a shortage of cores we must have your old re-buildable pump first before we can send out this pump.**

WATER PUMP REBUILD KITS

S-371 1941 Champion..... **\$60.00 ea.**

S-372 1941-42 President 8..... **\$60.00 ea.**

530834 Early 1951 V-8..... **\$65.00 ea.**

1548769 1959-61 170 6-cyl..... **\$60.00 ea.**

1558226 1962-64 170 6-cyl..... **\$65.00 ea.**

STUD-WATER PUMP MANIFOLD

- 527255** Water pump manifold & generator & alternator adjusting arm. 1951-64 V-8..... **\$5.40 ea.**

WATER PUMP MANIFOLD GASKET

- 527240** Upper, water pump manifold gasket. 1951-64 V-8 & 1963-64 Avanti. Temp sender plate. Takes 2..... **\$1.65 ea.**
- 527856** Lower, water pump manifold gasket. Lower, 1951-64 V-8 & 1963-64 Avanti Takes 2..... **\$1.60 ea.**

WATER PUMP GASKETS

- 527246** 1951-64 V-8 & 1963-64 Avanti..... **\$3.20 ea.**
- 534597** 1939-64 Champion 6-cyl..... **\$4.25 ea.**
- 1564226** Water pump plate. 1965 - 66 V-8..... **\$ 2.50 ea.**
- 1564228** Water pump. 1965-66 V-8..... **\$2.50 ea.**

AIR VENTILATOR KIT & RELATED PARTS



- 801428** Air Ventilator Kit. 1953-64 C & K model. Includes replacement fiberglass housings (4 pieces) for left and right fenders along with rubber seals (10), springs (2), bolts & nuts..... **\$309.95/kit**

AIR VENT HOUSING PIECES

- 284990** Front fender vent door, right or left. 1947-48 Champion..... **\$36.00 ea.**
- 284995W** Right side control lever. 1947-48 car. Chrome..... **\$25.00 ea.**
- 286202** Front fender vent door, right or left. 1947-48 Commander..... **\$30.00 ea.***
- 287648** Spring, vent door tension, right or left. 1947-52 car & 1957 sedan, left side only, 1953-56 sedan & 1953-64 coupe & Hawk..... **\$5.50 ea.**
- 290162** Left, vent lid in fender. 1949 Champion, 1949-52 Champion & Commander. 1953-56 all, & 1959-64 C & K..... **\$50.40 ea.**
- 290239P** Front fender vent door, right or left. 1949 Commander..... **\$35.00 ea.***



- 291097P** Left front air duct housing for all 1950 car..... **\$45.00 ea.**
- 293712P** Front fender vent door, right side only. All 1951-52 car..... **\$36.00 ea.**
- 294063X1** Right vent control cable & knob for early 1951 car..... **\$20.00 ea.**
- 304184P** Right, inner vent lid all complete with door, frame, hinge, & catch. 1953-64 C & K..... **\$38.25 ea.**
- 522293** Right vent door tension spring for 1953-56 sedan & all 1953-64 coupe & Hawk..... **\$5.50 ea.**
- 290165X3** Left front vent door control lever for 1956-58 car, zinc finish, also fits all 1949-53 car..... **\$15.00 ea.**
- 1314319** Lever, right ventilator control. 1956-64..... **\$13.25 ea.**

FANS



VISCOUS DRIVE

- 800356** Replacement fan for use with viscous drive on all models including 1963-64 Avanti. Six blades give improved cooling..... **\$89.95 ea.**

NOTE: This larger capacity fan produces more noise than the original. This is especially noticeable on Avanti. For use with viscous drive only.

- 1560257** Fan clutch. Replacement unit saves power, gives better cooling & reduces noise. 1963-64 all models with viscous including Avanti..... **\$79.95 ea.**



NONVISCIOUS DRIVE FANS

- 525047** 4-blade. 1947-49 Commander. Truck: 2R 6, 11, 14, 16, 17 **\$78.00 ea.**
- 530192** 4-blade. 1951-53 V-8 **\$75.00 ea.**
- 677063** 6-blade. Truck: M16, 17. 2-R 16, 17..... **\$95.00 ea.**
- 682919** 4-blade. Truck: 3R. E. 2E 6, 11 14, 16, 17. 3E-4E 3, 6, 11, 14, 16, 17 **\$85.00 ea.**
- 1540159** 4-blade. 1956-60 sedan & wagon V-8. Truck: 5E - 6E 7, 12..... **\$125.00 ea.**
- 1542138** 4-blade. 1956 Golden Hawk **\$135.00 ea.**
- 1552246P** 6-blade Heavy Duty. 1961-63 6-cylinder. **\$65.00 ea.**
- 1556170** 4-blade. Truck: 7E-8E 7, 12. 8E 13, 28, 40 late..... **\$65.00 ea.**
- 1561633** 4-blade. 1964 Lark 6-cylinder without air conditioning. Truck 8E 5, 10 late..... **\$50.00 ea.**
- 1564695** 4-blade. 1965-66 6-cylinder & V-8 without air conditioning **\$60.00 ea.**
- 1565484** 6-blade. 1965 - 66 Lark V-8 with air conditioning **\$75.00 ea.**
- 1692378** 6-blade. Truck: Special order V-8 5E - 8E 7, 12, 13, 28, 40. Will also work as a heavy duty replacement on V-8 models requiring extra cooling **\$75.00 ea.**
- 1694205** 6-blade. Truck: 7E - 8E 35, 45. **\$75.00 ea.**
- 1696462** 6-blade. Truck: 8E 15, 25. **\$75.00 ea.**



FRESH AIR VENT SCREEN

- 285005P** 1947-52 sedan, left and right side, 1953-57 sedan, right side, 1953-64 C & K (includes Hawk), right side **\$22.00 ea.**

THERMOSTATS

Gaskets are not included

- 531470** 160°. Truck: 2R-5E 1, 5, 10, 15 & 6E-8E 5,7, 10, 12, 13, 28, 40..... **\$10.25 ea.**



- 533247** 160°. 1938-42 Commander & President, 1947-50 Commander 6-cylinder, 1951-60 V-8 except 1956 Golden Hawk. Truck: M16, M17 & 2R-5E except 1, 5, 10, 15..... **\$13.00 ea.**



- 533257** 180°. 1938-42 Commander & President, 1947-50 Commander 6-cyl., 1951-60 V-8 except 1956 Golden Hawk. Truck: M16, M17 & 2R-5E except 5, 10, 15. **\$15.25 ea.**

- 1540787** 170° 1938-42 Commander & President, 1947-50 Commander 6-cylinder, 1951-60 V-8 except 1956 Golden Hawk. Truck: M16, M17 & 2R-5E except 5, 10, 15. NOS..... **\$18.00 ea.**

- 1560842** 160°. 1939-60 Champion. 1956 Golden Hawk, 1961-66 car, all models & 1963-85 Avanti. Truck: M5, M15, M15A **\$10.70 ea.**

- 1560843** 180°. 1939-60 Champion. 1956 Golden Hawk. 1961-66 car, all models & 1963-85 Avanti. Truck: M5, M15, M15A. **\$12.80 ea.**

FAN SHROUDS

Availability is extremely limited on some NOS units.



- 524605** 1950 Commander. **\$95.00 ea.**
- 524957** 1950 Champion..... **\$95.00 ea.**
- 535263P** 1954-55 Champion, sedan, & wagon. **\$95.00 ea.**
- 535274** 1954 Commander sedan..... **\$95.00 ea.**
- 800700** 1966-85 Avanti. All models without electric fan... **\$179.00 ea.**
- 1542867P** 1957 Packard with air conditioning **\$120.00 ea.**
- 1546334P** 1958 Hawk V-8, right hand drive, all except Golden Hawk. Also fits all V-8 1959-64 Hawks w/o air conditioning **\$140.00 ea.**
- 1546341P** 1958 Hawk 6-cylinder cars with right hand drive. Also fits all 6-cylinder 1959-64 Hawks w/o air conditioning **\$140.00 ea.**
- 1547053** 1959-60 Lark V-8 **\$205.00 ea.**
- 1547097** 1958 Silver Hawk V-8 **\$140.00 ea.**
- 1548467P** 1959-60 Lark 6-cylinder. **\$150.00 ea.**
- 1550696** 1961-64 Lark 6-cyl. **\$150.00 ea.**
- 1550705** 1961-64 Lark V-8 **\$205.00 ea.**
- 1557508P** 1961-64 6-cylinder Lark. **\$95.00 ea.**
- 1560614** 1963-64 Avanti. **\$179.00 ea.**
- 1560614X1** 1963-64 Avanti with open bottom for easier removal. Pictured. **\$169.00 ea.**
- 1685691P** 1956 2E truck, models 7 through 38. Any with Commander 6-cyl.or V-8 engines. Left side only..... **\$75.00 ea.**
- 1695995** 1963-64 8E 15 & 25. **\$147.50 ea.**

THERMOSTAT HOUSING GASKETS

- 186888** 1936-50 Commander 6-cyl. **\$2.00 ea.**
- 194658** 1939-60 Champion. Thermostat sleeve **\$1.50 ea.**
- 194660** 1939-60 Champion 6-cyl. **\$1.45 ea.**
- 527284** 1951-60 V-8..... **\$1.50 ea.**
- 1550816** 1961-64 6-cyl. & 1961-64 V-8 including Avanti. **\$1.60 ea.**
- 1564064** 1965 - 66 6-cylinder **50¢ ea.**
- 1564066** 1965-66 V-8 & 1966-85 Avanti **\$1.50 ea.**

THERMOSTAT SPACER

- 196709** 1939-60 Champion 6-cyl. ... **\$8.50 ea.**

WATER OUTLET

(Thermostat housing)



- 529412** Car: 1956-60 V-8 all except C & K. Truck: V-8 all models 1954-64 except 6E through 8E 7 & 12..... **\$30.00 ea.**
- 532115** Car: 1953-60 Champion 6 cylinder. Truck: 5-E 5 **\$36.00 ea.**
- 532383** Car: V-8 1953-55 all, 1956-60 C & K.... **\$36.00 ea.**
- 1539099** 1956 Golden Hawk..... **\$65.00 ea.**
- 1550844** 1961-64 all 6-cylinder & V-8 car, except Avanti Pictured. Truck: 6E - 8E 7 & 12..... **\$37.50 ea.**
- 1564065** 1965 - 66 6-cylinder. **\$27.00 ea.**

WATER TEMPERATURE SENDERS

- 530127** 1950-52 car all models, 6-V **\$45.00 ea.**
- 532579** 1953-55 car all models, 6-V. **\$45.00 ea.**
- 1543609** 1957-58 Packard **\$28.00 ea.**
- 1545220** Late 1957-64 V-8 all models including Avanti. Truck:3E-4E 1, 5, 10 & 3E-8E 2, 7, 12,13, 28, 38, 40 **\$33.35 ea.**
- *1549452** 1959-64 6-cylinder. Truck: 4E-8E 1, 5, 10..... **\$29.75 ea.**
- 1565609** All 1965-66..... **\$38.00 ea.**

*Currently on back order as of publication.

www.studebaker-intl.com

THERMOSTAT, SPACER & GASKET SETS



(Includes 194660 & 194658 gasket, 196709 spacer & 1560842 or 1560843 thermostat)

- 801371** 160° 1939-60 Champion 6-cylinder **\$19.75 ea.**
- 801372** 180° 1939-60 Champion 6-cylinder **\$19.75 ea.**

HEATER CORE

(Circular Type)



515428 1942 Commander and President. Does not include fan, motor, or filter as shown in photo.....**\$150.00 ea.**

HEATER CORES

517890 1947-52 cars. All models...**\$325.00 Ex.**

524234 1941-48 M-series truck.....**\$325.00 Ex.**

527350 1953-58 all cars plus 59-62 Hawk.....**\$325.00 Ex.**

680717 Early 2R truck, type "A" heater.....**\$225.00 Ex.**

681254 2R truck with type "B" heater.....**\$325.00 Ex.**

681470 2R truck with type "C" heater. First type.....**\$325.00 Ex.**

684656 2R truck with type "C" heater. 2nd type and all 3R (1954) through 3E (1958) and early 4E (1959).....**\$325.00 Ex.**

1552127 1961-63 Lark.....**\$325.00 Ex.**

1556925 1963- 85 Avanti.....**\$325.00 Ex.**

1561425 1964-66 Lark.....**\$325.00 Ex.**

1691703 Late 4E (1959) through 6E (1961) C-cab trucks and 7E & 8E C-cab trucks with type "A" heater.....**\$325.00 Ex.**

1695417 7E (1962) and 8E (1963-64) C-cab trucks model: 15, 25, 35, & 45 with type "B" heater.....**\$325.00 Ex.**

1695442 Car: 1959-60 Lark and 1963-64 G.T. Hawk. Truck: 1960-64 C-cab.....**\$325.00 Ex.**

Note: All cores listed are either new or reconditioned and are guaranteed for one year from date of purchase. All cores are sold on an Exchange basis and we require your old core first. Please allow 30 days for shipping.

HEATER CORE COVER

524853 1959-62 Hawk.....**\$41.50 ea.**

1549706 Fiberglass. 1959-60 Lark, 1963-64 Hawk. Truck: 1960-64 Champ.....**\$87.50 ea.**



HEATER BLOWER TUBE



533981 Tube, heater blower hose to heater core cover, 1953-58 car, all models & 1959-62 Hawk. Fiberglass.....**\$95.00 ea.**

HEATER SEALS

519358 Seal. Air duct to fender apron. 1947-52 car, all models.....**\$8.50 ea.**



519409 Heater neck seal. For all models with heater under seat Takes 2.....**\$2.00 ea.**

1332334 Seal, heater plenum to inner fender. 1959-60 Lark. 1963-64 Hawk. Truck: 1960-64 Champ..**\$8.50 ea.**



1339224 Seal, heater core housing. 1961-66 Lark...**\$8.50 ea.**

1556923 Seal, heater core housing. 1963-85 Avanti.**\$8.50 ea.**

1556912 Seal, heater housing to firewall. 1963-85 Avanti.....**\$5.50 ea.**



1556913 Seal, heater housing to side panel. 1963-85 Avanti.....**\$6.50 ea.**



HEATER PARTS 1947-66

195407 Heater hose clamp. Holds 2 hose. 1939-66, most models.....**\$8.00 ea.**

293762 Grommet, through dash, heater motor cable. 1951-52 car.....**\$3.50 ea.**



519799 Moulded, defroster blower hose. 1947-48, all models.....**\$24.00 ea.**

520201 Fan blades for heater blower motor. All 1947-52 car and 1957 sedan.....**\$22.75 ea.**

523056 Circuit breaker. 1947-50, all models.....**\$25.00 ea.**

524853 Heater core housing, under passenger seat. 1949-58 car.....**\$41.50 ea.**

529497 Air duct housing, right side fender vent housing to blower hose. 1947-52 car....**\$75.00 ea.**

530283 Heater valve control cable. 1951 car....**\$12.00 ea.**

531749 Heater valve control cable. 1952 car....**\$12.00 ea.**

532523X1 Heater control cable. 1953-55 except C & K.....**\$30.00 ea.**

533302P Bracket for heater valve cable, mounts under dash. All 1953 car.....**\$12.00 ea.**

535124P Bracket for heater valve cable, mounts under dash. All 1954 car & 1955 without wraparound windshield.....**\$8.50 ea.**

679393 Adapter fitting for control valve, screws into cylinder head. 1947-49 car.....**\$8.50 ea.**

1539973 Heater cable control assembly, mounts on dash. 1956 sedan & wagon.....**\$22.25 ea.**

1541983 Heater cable control assembly, mounts on dash. 1957-58 car.....**\$22.25 ea.**

1542173 Heater valve control cable, 1957 sedan & wagon.....**\$8.50 ea.**

1542174 Heater valve control cable, 1957 Hawk.....**\$8.50 ea.**

HEATER VALVES



These replacement heater valves closely resemble the original valves. Except the on/off positions are reversed. If your controller is presently pushed in when turned off it will now be pulled out to be off. If moving the lever to the left turns it off then the off position will now require sliding the lever to the right.

800782 Replacement for various models. Has 3/4" X 3/4" hose fittings. Wire pulls to close valve.....**\$88.80 ea.**

800783 Replacement for various models. Has 5/8" X 5/8" hose fittings. Wire pulls to close valve.....**\$88.30 ea.**



HEATER ELBOWS & NIPPLES

522850 Elbow, heater hose to cylinder head. 1947-52 6-cylinder.....**\$15.00 ea.**

531543 Nipple, inlet hose to water pump manifold & outlet hose to water pump. 1955-58 V-8 Takes 2.....**\$12.00 ea.**

537833 Elbow, inlet to cylinder head, also outlet to water pump. 1953-58 Champion. Takes 2.....**\$8.00 ea.**

1548305 Nipple, heater hose to water manifold. 1959-64 most model car & truck.....**\$10.75 ea.**

1692762 Elbow, heater hose to water manifold. 1959-64 most model cars and trucks.....**\$7.50 ea.**



HEATER HOSES

- 800955** Black 3/4" heater hose for all 1959-66 models, including 1963-85 Avanti. 8' length **\$16.00 ea.**
- 801972** Black 5/8" heater hose for most models through 1962. 16' length. **\$51.25 ea.**



- 1555917** Heater hose with molded ends for 1963-64 Hawk. Connects to heater core on fender apron to thermostat valve on firewall ... **\$15.00 ea.**

HEATER/DEFROSTER MOTORS

- 519419P** Defroster heater coil. 1947-58 car, all models & 1959-62 Hawk **\$60.00 ea.**
- 534238** Heater. 1953-55 car, all models **\$132.00 ea.**
- 1540100** Defroster. 1956-58 all models, 1959-61 Hawk **\$185.00 ea.**
- 1542747** Heater. 1957-58 sedan **\$85.00 ea.**
- 1552255** Heater. 1959-61 Lark **\$110.00 ea.**
- 1554990** Heater. 1962 Hawk with auxiliary heater **\$94.00 ea.**
- 1556924** Heater & defroster. 1963-85 Avanti ... **\$185.00 ea.**
- 1558701** Heater & defroster. 1963-64 Hawk **\$105.00 ea.**
- 1558703** Blower assembly. 1963-64 GT Hawk . **\$135.00 ea.**
- 1561261** Heater & defroster. 1962-66 Lark. **\$100.00 ea.**
- 1561418** Heater. 1962-66 Lark **\$115.00 ea.**

HEATER/DEFROSTER DUCTS

- 525350** Defroster outlet.  1949-52 Cars **\$30.00 ea.**
- 800514** Defroster. 1 3/4" X 6'. 1949-58 all models. Takes 1 **\$50.90 ea.**
- 800515** Defroster. 2" X 6', 1959-66 all models & 1963-85 Avanti. Takes 1 **\$43.50 ea.**
- 800516** Left fender fresh air intake. 3-1/2". 1957-58 sedan. 1959-60 Lark. Truck: 1960-64 Champ.. **\$11.30 ft.**
- 800517** Heater motor to under seat. 4" X 72". 1947-60 all models. 1961-62 Hawk **\$55.65 ea.**
- 800517X1** Heater plenum to firewall. 4". 1959-60 Lark, 1963-64 Hawk. Truck: 1960-64 Champ. Limited to 3 continuous ft. **\$9.25/per ft.**
- 801816** Right fender air intake hose 4". 1947-52 car. Includes one 32" piece & one 6" piece **\$29.00/set**

HEATER DUCT CLAMPS

- G451236** 3 1/2" . NOS... **\$4.50 ea.**
- G451244** 4". NOS..... **\$6.50 ea.**



HEATER/DEFROSTER VALVES & SEALS

- 800524** Air vent seals. 1963 Avanti .. **\$15.00 kit**
- 800525** Air vent seals. 1964-85 Avanti. **\$15.00 kit**
- 1556916** Heater/defrost valve. 1963-85 Avanti. NOS **\$22.50 ea.**

HEATER & DEFROSTER PARTS 1959-60 Lark & 1960-64 Champ truck

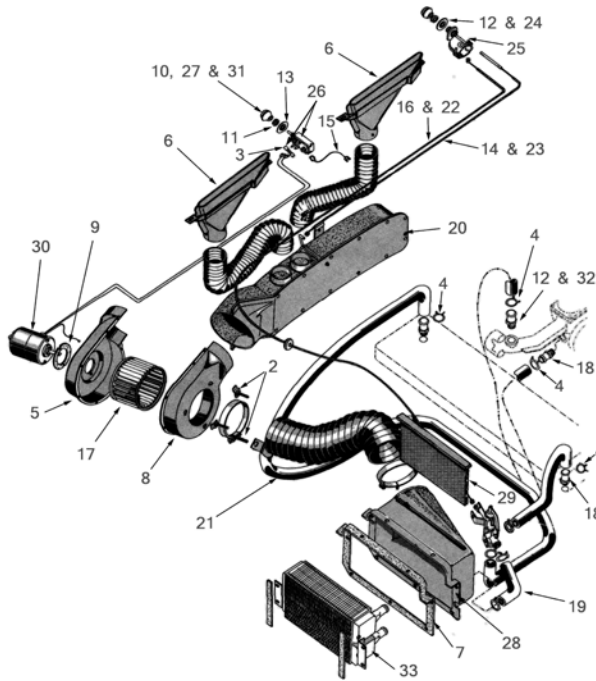

1. **2081X7** Mounting screw for air duct. Takes 2 **75¢ ea.**
2. **3081X2** Bolt and clip to dash for lower blower hose. 1959-60 Lark. Truck: 1960-64 Champ. Takes 3 **80¢ ea.**
3. **G120151** Fuse, fan switch. 1959-60 Lark. Truck: 1960-64 Champ. **\$1.50 ea.**
4. **G272852** 3/4" hose clamp - for heater hose, 1959-64 and other various applications 1959-60 Lark. Truck: 1960-64 Champ **\$1.00 ea.**
5. **534273** Blower housing, rear half. 1959-60 Lark. **\$21.60 ea.**
6. **1331665** Defroster outlet. 1959-60 Lark. Truck: 1960-64 Champ **\$22.50 ea.**
7. **1332334** Gasket, core housing. 1959-60 Lark. Truck: 1960-64 Champ. **\$8.50 ea.**
8. **1348276P** Blower housing, front half. 1959-60 Lark. Truck: 1960-64 Champ ... **\$18.00 ea.**
9. **1540092** Gasket, blower motor to housing. 1959-60 Lark. Truck: 1960-64 Champ **\$5.00 ea.**
10. **1543617** Knob, valve control. 1959-60 Lark regal. Chrome. **\$16.00 ea.**
11. **1547329** Escutcheon, "Air". 1959-60 Lark. Truck: 1960-64 Champ **\$7.50 ea.**
12. **1547331** Escutcheon, "Heat". 1959 Lark **\$7.50 ea.**
13. **1547334** Switch with fuse. 1959 Lark. Heater & Defroster **\$27.00 ea.**
14. **1547690** Cable & conduit, control to valve. 1959 Lark. Type A **\$13.25 ea.**
15. **1547697** Cable, fan switch to ignition. 1959-60 Lark. Truck: 1960-64 Champ **\$7.50 ea.**
16. **1548255** Heater valve control cable, 1959 Lark w/type "A" heater control (See page #9 in 1959-64 body parts book)..... **\$10.00 ea.**
17. **1548305** Nipple, on engine and water manifold. 1959-60 Lark. Truck: 1960-64 Champ **\$10.75 ea.**
18. **1548314** Formed hose, valve to core inlet. 1959-60 Lark V-8. Truck: 1960-64 Champ V-8 and 6-cylinder **\$8.00 ea.**
19. **1548497X1** Formed hose, engine to control valve. 1959-60 Lark V-8. Truck: 1960-64 Champ V-8. **\$13.50 ea.**
20. **1548497X3** Formed heater hose, engine to control valve. 1959-60 Lark 6. **\$39.95 ea.**
21. **1549153** Cable & conduit, control to valve. 1959-60 Lark. Truck: 1960-64 Champ **\$15.00 ea.**
22. **1549157** Cable & conduit, control to valve. 1959-60 Lark. Truck: 1960-64 Champ. Type B. **\$8.50 ea.**
23. **1549161** Escutcheon, "Heat - Pull". 1959-60 Lark. Truck: 1960-64 Champ. **\$5.75 ea.**
24. **1549346** Control, heater & defroster. 1960 Lark. Truck: 1960-64 Champ **\$25.00 ea.**
25. **1549565** Switch with fuse. 1960 Lark. Truck: 1960-64 Champ **\$35.00 ea.**
26. **1549590** Knob, valve control (white). 1960 Lark Deluxe **\$8.50 ea.**
27. **1549706** Housing, heater core. 1959-60 Lark. Truck: 1960-64 Champ. **\$87.50 ea.**
28. **1550084** Filter. 1959-60 Lark. Truck: 1960-64 Champ **\$22.50 ea.**
29. **1552255** Blower motor. 1959-60 Lark. Truck: 1960-64 Champ **\$100.00 ea.**
30. **1554118** Black knob, valve control. 1959 Lark deluxe. Truck: 1960-64 Champ **\$12.50 ea.**
31. **1692762** Elbow, on water manifold. 1959-60 Lark. Truck: 1960-64 Champ **\$7.50 ea.**
32. **1695442** Heater core, rebuilt exchange. 1959-60 Lark. Truck: 1960-64 Champ **\$325.00 Ex.**
33. **1539888** Knob, valve control. Black. 1960-61 Champ truck. **\$8.50 ea.**
- 3148X1** Push nut. Used when installing fan blades. **\$1.25 ea.**
- 1332060** Right, heater & fresh air valve. 1959-60 Lark. Truck: 1960-64 Champ. .. **\$24.75 ea.**
- 1332061** Left, heater & fresh air valve. 1959-60 Lark. Truck: 1960-64 Champ. **\$24.75 ea.**

HEATER & DEFROSTER PARTS 1959-62 Hawk

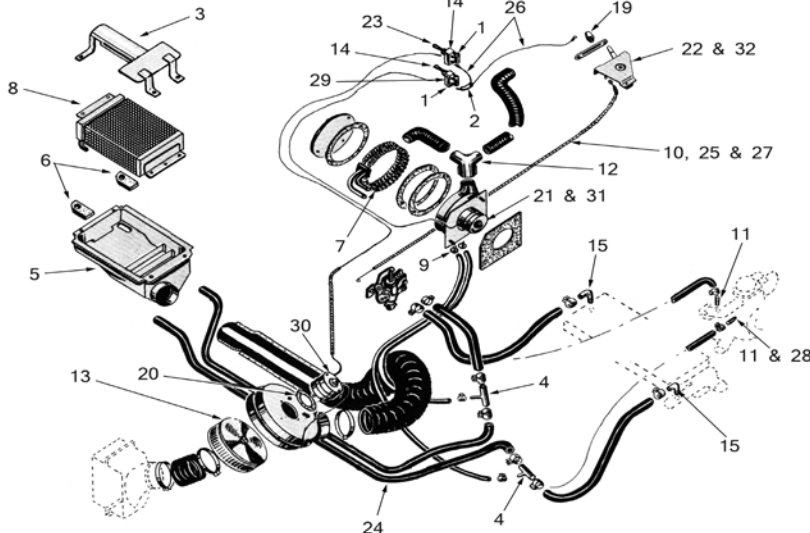

- | | |
|---|--|
| 1. G147685 Defroster fuse. 1959-62.....
..... \$1.00 ea. | 11. 531546 Nipple, upper water manifold. 1959-62.....
..... \$7.25 ea. |
| 2. 192545 Connector, motor to switch cable. 1959-61.....
..... \$6.50 ea. | 12. 532433 Defroster outlet. 1959-62.....
..... \$12.50 ea. |
| 3. 198650P Outer cover, defroster heater coil. 1959-62.....
..... \$7.50 ea. | 13. 532871 Blower fan. 1959-62.....
..... \$26.00 ea. |
| 4. 198653 Defroster "T" fitting. 1959-62.....
..... \$24.00 ea. | 14. 536350W Retaining nut, fan switch to dash. 1959-62.....
..... \$5.50 ea. |
| 5. 198777P Inner cover, defroster heater coil. 1959-62.....
..... \$7.00 ea. | 15. 537833 Elbow to cylinder head. 1959-62 6-cylinder.....
..... \$8.00 ea. |
| 6. 519409 Grommet, heater core to housing. 1959-62. Takes 2.....
..... \$2.00 ea. | 16. 1331665 Defroster outlet. 1959-60.....
..... \$22.50 ea. |
| 7. 519419P Defroster heater coil. 1959-62.....
..... \$60.00 ea. | 17. 1338766 Right defroster outlet. 1961-62.....
..... \$26.50 ea. |
| 8. 527350 Heater core, rebuilt exchange. 1959-62.....
..... \$325.00 Ex. | 18. 1338767 Left defroster outlet. 1961-62.....
..... \$26.50 ea. |
| 9. 530097 Clip to dash. 1959-62.....
..... \$3.95 ea. | 19. 1540033 Knob, valve control. 1959-62.....
..... \$12.50 ea. |
| 10. 531534 Clip, control cable to dash. 1959-62.....
..... \$1.00 ea. | |

HEATER & DEFROSTER PARTS

1963-64 Hawk V-8

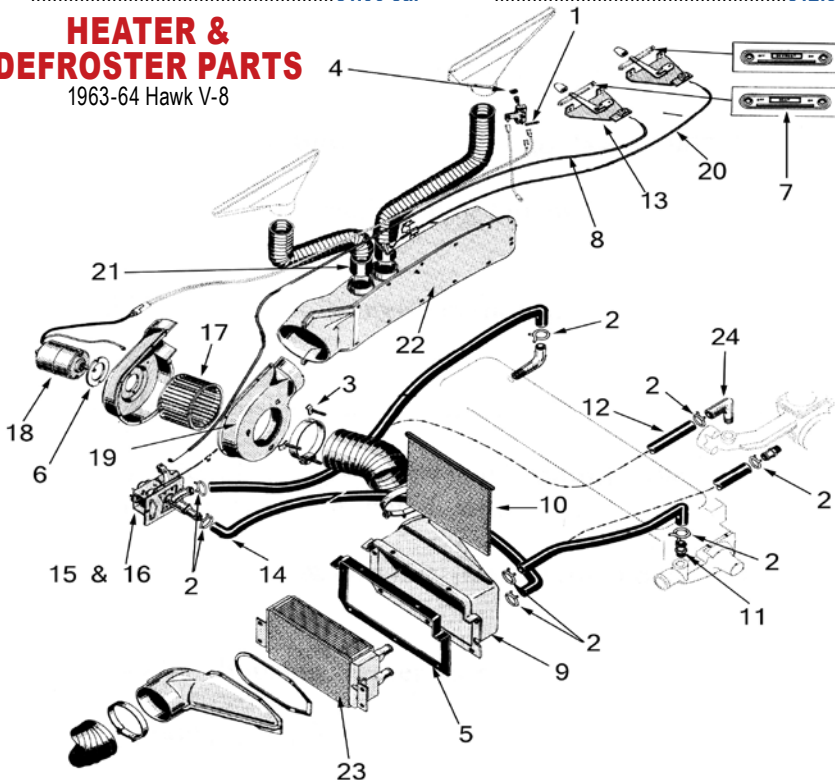

- | |
|---|
| 20. 1540092 Gasket, motor to blower. 1959-62.....
..... \$5.00 ea. |
| 21. 1540100 Defroster motor, 1959-61.....
..... \$185.00 ea. |
| 22. 1541983 Heater temperature control. 1959-61.....
..... \$22.25 ea. |
| 23. 1544278 Defroster fan switch, 1959-61.....
..... \$32.50 ea. |
| 24. 1544548 Clip, hose to fender. 1959-62.....
..... \$4.25 ea. |
| 25. 1544549 Cable & conduit, control to valve, 43-1/4". 1959-61.....
..... \$10.25 ea. |
| 26. 1545032 Cable, heater & defroster switch to ignition. 1959-61.....
..... \$7.25 ea. |
| 27. 1545870 Wire, control to valve, 43-1/4". 1959-61.....
..... \$4.25 ea. |
| 28. 1553804 Nipple to water manifold with air conditioning.....
..... \$4.00 ea. |
| 29. 1554978 Heater fan switch with fuse, 1962.....
..... \$36.00 ea. |
| 30. 1554985 Heater motor. 1962.....
..... \$100.00 ea. |
| 31. 1554990 Defroster motor. 1962 with auxiliary motor.....
..... \$90.00 ea. |
| 32. 1555755 Heater temperature control. 1962.....
..... \$22.25 ea. |
| 800517 Hose, heater motor to under seat. 4"x72". 1961-62 Hawk.....
..... \$49.50 ea. |

HEATER & DEFROSTER PARTS 1963-64 Hawk V-8

- | |
|--|
| 1. G147685 Fuse, on heater switch. 1963-64.....
..... \$1.00 ea. |
| 2. G272852 3/4" hose clamp for heater hose, 1959-64 and other various applications.....
..... \$1.00 ea. |
| 3. 3081X10 Bolt, blower assembly to dash. 1963-64.....
..... \$2.50 ea. |
| 4. 536350W Chrome retainer nut, fan switch to inst. panel. 1963-64.....
..... \$5.50 ea. |
| 5. 1332334 Gasket, heater core housing to fender. 1963-64.....
..... \$8.50 ea. |
| 6. 1540092 Gasket, blower motor to housing. 1963-64.....
..... \$5.00 ea. |
| 7. 1541980 Chrome bezel, "Heat" control. 1963-64.....
..... \$12.80 ea. |
| G157105 Screw to instrument. panel. 1963-64.....
..... 70¢ ea. |
| 8. 1542174 Cable & conduit, heater temp control to valve. 1963-64.....
..... \$8.50 ea. |
| 9. 1549706 Housing, heater core. 1963-64.....
..... \$87.50 ea. |
| 10. 1550084 Filter, heater core housing. 1963-64.....
..... \$22.50 ea. |
| 11. 1552366 Water manifold lower nipple. 1963-64.....
..... \$13.25 ea. |
| 12. 1553640 Heater hose, engine to control valve. 1963-64.....
..... \$16.50 ea. |
| 13. 1555755 Temperature control lever. 1963-64.....
..... \$20.00 ea. |
| 14. 1555917 Formed heater hose, control valve to core inlet. 1963-64.....
..... \$15.00 ea. |
| 15. 1558697 Control valve (hot & cold settings reversed). 1963-64.....
..... \$89.95 ea. |
| 16. 1558697X Control valve. Rebuilt exchange. 1963-64. Call before ordering.....
..... \$89.95 Ex. |

HEATER & DEFROSTER PARTS

- 1963-64 Hawk V-8 (Continued)
- 17. **1558698** Blower fan. 1963-64 .. **\$26.50 ea.**
 - 18. **1558701** Blower motor. 1963-64..... **\$105.00 ea.**
 - 19. **1558702** Blower housing, front half. 1963-64..... **\$18.00 ea.**
 - 20. **1558772** Cable & conduit, defroster control to distribution box. 1963-64..... **\$7.25 ea.**
 - 21. **1558783** Adapter, defroster hose to distribution box. 1963-64..... **\$4.25 ea.**
 - 23. **1695442** Heater core, rebuilt exchange. 1963-64..... **\$325.00 Ex.**
 - 24. **1692762** Water manifold upper elbow. 1963-64..... **\$7.50 ea.**
 - 1331825** Cable retainer clip..... **\$2.50 ea.**

HEATER & DEFROSTER PARTS

- 1961-66 Lark
- 1. **532871** Blower fan. 1962-66 Lark..... **\$26.00 ea.**
 - 2. **1312347** Clip to fender apron or cowl. 1961-66 Lark..... **\$4.25 ea.**
 - 3. **1339224** Gasket, housing to body. 1961-66 Lark..... **\$8.50 ea.**
 - 4. **1540092** Gasket, motor to housing. 1961 Lark..... **\$5.00 ea.**
 - 6. **1548305** Nipple, heater hose to engine. 1961-66 Lark..... **\$7.50 ea.**
 - 7. **1548497X1** Formed hose, control valve to core inlet. 1961 Lark..... **\$13.50 ea.**
 - 8. **1549155** Cable & conduit, control to temperature valve. 1961 Lark..... **\$20.00 ea.**
 - 9. **1549157** Cable & conduit, control to temperature valve. 1963 Lark. Control to defroster valve, 1961 Lark without air conditioning and 1962 Lark..... **\$8.50 ea.**
 - 10. **1549160** Cable & conduit, heater control to defroster valve. 1961 Lark with air conditioning..... **\$7.00 ea.**
 - 11. **1549346** Control, heater & defroster. 1961-62 Lark..... **\$25.00 ea.**
 - 12. **1549565** Fan switch with fuse. 1961 Lark .. **\$30.00 ea.**
 - 13. **1555179** Formed hose, control valve to core inlet. 1962 Lark..... **\$5.00 ea.**
 - 14. **1552031** Air distribution duct. 1961-62 Lark..... **\$82.00 ea.**
 - 15. **1552055** Blower housing, lower half. 1961 Lark..... **\$18.50 ea.**
 - 16. **1552056** Housing, heater core. 1961-66 Lark..... **\$32.00 ea.**
 - 17. **1552094** Filter. 1961-66 Lark..... **\$22.50 ea.**
 - 18. **1552127** Heater core, rebuilt exchange. 1961-63 Lark..... **\$325.00 Ex.**
 - 19. **1552177** Escutcheon, "Fan". 1961-62 Lark..... **\$7.00 ea.**
 - 20. **1552178** Escutcheon, heater valve control. 1961-62 Lark..... **\$7.00 ea.**

HEATER & DEFROSTER PARTS

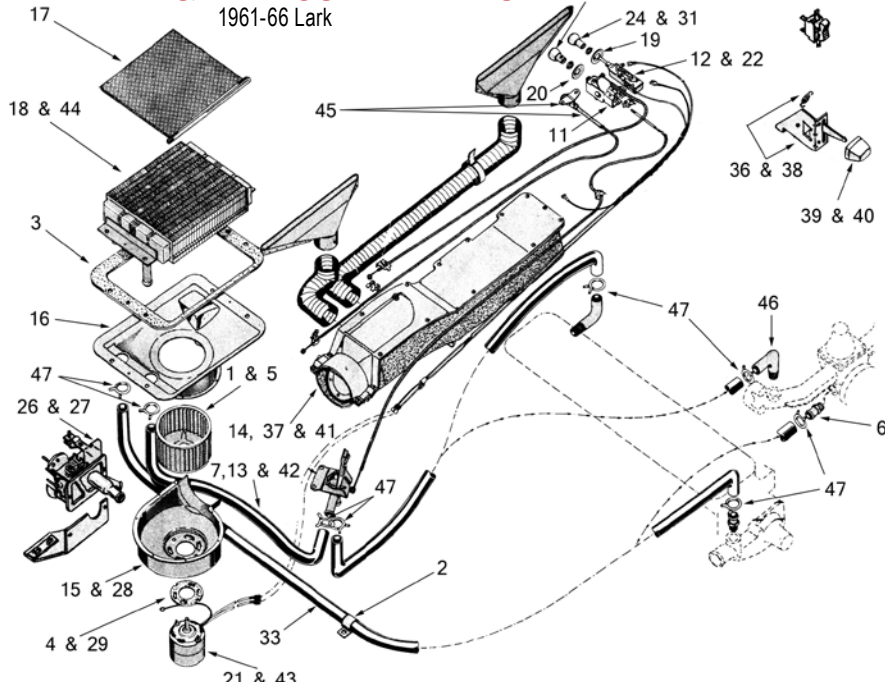

- 21. **1552255** Blower motor. 1961 Lark..... **\$100.00 ea.**
- 22. **1553638** Formed hose, engine to control valve. 1961 Lark 6-cyl..... **\$17.50 ea.**
- 23. **1554118** Black knob, heater valve control. 1961 Lark..... **\$12.50 ea.**
- 24. **1554118** Black knob, fan switch. 1961 Lark..... **\$12.50 ea.**
- 25. **1554524** Cable & conduit, control to temperature valve. 1962 Lark..... **\$13.25 ea.**
- 26. **1554534** Heater control valve, 1962-66 Lark. Hot & cold settings are reversed..... **\$89.95 ea.**
- 27. **1554534X** Heater control valve, rebuilt exchange. 1962-66 Lark..... **\$89.95 Ex.**
- 28. **1554930** Blower housing, lower half. 1962-66 Lark..... **\$18.00 ea.**
- 29. **1554932** Gasket, motor to housing. 1962-66 Lark..... **\$2.00 ea.**
- 30. **1554974** White knob, heater valve control. 1962 Lark..... **\$12.50 ea.**
- 31. **1554974** White knob, fan switch. 1962 Lark..... **\$12.50 ea.**
- 32. **1555074** Fan switch with fuse. 1962 Lark... **\$41.00 ea.**
- 33. **1555910** Formed hose, core outlet to water pump. 1962-63 Lark 6-cyl..... **\$17.50 ea.**
- 34. **1557684** Cable & conduit, heater control to defroster valve. 1963-66 Lark..... **\$7.50 ea.**
- 35. **1557686** Cable & conduit, control to temperature valve. 1964-66 Lark... **\$8.50 ea.**
- 36. **1558834** Control, heater & defroster. 1963 Lark..... **\$12.00 ea.**
- 37. **1558927** Air distribution duct. 1963 Lark. 1964-66 Lark with air conditioning..... **\$82.00 ea.**
- 38. **1560365** Control, heater & defroster. 1964-66 Lark..... **\$12.00 ea.**
- 39. **1560516W** Knob, "Heat". 1963-66 Lark..... **\$8.00 ea.**
- 40. **1560517W** Knob, "Def", defroster valve control. Chrome. 1963-66 Lark..... **\$8.00 ea.**
- 41. **1560957** Air distribution duct. 1964 Lark without air conditioning & all 1965-66..... **\$85.00 ea.**
- 43. **1561418** Blower motor. 1964-66 Lark..... **\$115.00 ea.**
- 44. **1561425** Heater core, rebuilt exchange. 1964-66 Lark..... **\$325.00 Ex.**
- 45. **1562151** Cable & conduit, air intake valve. 1964-66 Lark..... **\$24.00 ea.**
- 46. **1692762** Elbow, heater hose to water manifold. 1961-64 Lark..... **\$7.50 ea.**
- 47. **G272852** 3/4" hose clamp for heater hose, 1959-64 and other various applications. 1961-66 Lark..... **\$1.00 ea.**
- 1548225** Cable for air intake valve. Located in air distribution duct under dash. 1961-66 Lark..... **\$26.50 ea.**
- 1548497X15** Formed heater hose, control valve to heater core outlet to water pump. 1962-63 V-8 Lark..... **\$39.95 ea.**
- 1548497X18** Formed heater hose, engine to control valve. 1962-64 Lark..... **\$44.00 ea.**
- 1558927** Air distribution duct, 1963-64 Lark with air conditioning..... **\$76.00 ea.**
- 1559745** Formed heater hose (short) to core inlet. 1963 Lark..... **\$12.50 ea.**
- 1561307** Formed heater hose, control valve to heater core inlet, 1964-66 Lark..... **\$8.50 ea.**

EVAPORATOR MOTORS

1553061

Motor, evaporator blower. 1961 Lark. Pictured. . . **\$94.00 ea.**



1565485

Blower fans & motor assembly. 1965-66 all..... **\$137.50 ea.**

EVAPORATOR FANS

1549296 Fan, evaporator blower motor. 1959-61 Lark. Pictured **\$32.50 ea.**



EVAPORATOR BRACKETS & HOUSINGS

1548276P Blower housing front half, 1959-60 Lark..... **\$18.00 ea.**

1555482 Panel, evaporator face. 1959-60 Lark, 1961 Hawk. Pictured below..... **\$96.50 ea.**

1555484 Grille, evaporator face panel. 1959-60 Lark, 1961 Hawk..... **\$28.50 ea.**

1555486 deflector, evaporator air. 1959-60 Lark..... **\$20.00 ea.**

1552487 Upper housing, evaporator blower, 1961 Lark..... **\$36.00 ea.**

1555982 Bracket, evaporator to dash, 1962 convertible..... **\$16.50 ea.**

1562953 Bracket, evaporator to dash. 1964 Hawk..... **\$7.00 ea.**

1562955 Bracket, evaporator side support. 1964 Hawk without heater..... **\$9.50 ea.**

1565384 Housing, right evaporator blower. 1965-66 all..... **\$24.00 ea.**

1565385 Housing, left evaporator blower. 1965-66 all..... **\$24.00 ea.**

HOSES

1545962 Hose, condenser to evaporator liquid. 1959-61 Lark V-8... **\$86.50 ea.**



1545966

Hose, condenser to evaporator. 1961-63 Lark & Hawk V-8..... **\$76.50 ea.**

1548356 Hose, compressor to condenser. 1962-64 Hawk..... **\$26.00 ea.**

1561404 Hose, evaporator to compressor suction, 1964 Hawk..... **\$63.00 ea.**

1565429 Hose, compressor to drier tank. 1965-66 6-cylinder..... **\$75.00 ea.**

1565430 Hose, compressor to condenser. 1965-66 all..... **\$63.00 ea.**

1565431 Hose, compressor to evaporator. 1965-66 6-cylinder..... **\$107.50 ea.**

1565432 Hose, compressor to evaporator. 1965-66 V - 8. **\$85.00 ea.**

HOSE GROMMETS

1548829 Hose grommet, to dash and air deflector. 1959-64 Lark & Hawk..... **\$5.00 ea.**

1548831 Hose grommet to dash. 1959-64 Lark & Hawk... **\$3.95 ea.**



AIR CONDITIONER CONDENSER

1541732 1956 Golden Hawk. Should fit other Hawks also..... **\$225.00 ea.**



AIR CONDITIONER BEZEL

1558074 Air conditioner bezel. Plastic/chrome for 1963-65 Lark & 1963-64 Hawk. Takes 4. 1963-64 Avanti. Takes 2.. **\$13.05 ea.**

DRIER TANK

1550747 Drier tank. 1961-63 Lark..... **\$107.50 ea.**

COMPRESSOR & RELATED PARTS



1546048 Compressor clutch & pulley. 1957-58 supercharged cars..... **\$375.00 ea.**

1546054 Valve, compressor suction. 1965-66 all..... **\$37.50 ea.**



1549298 Brush, holder & cable assembly., compressor clutch. 1959-60 Lark. **\$24.50 ea.**

1550770 Seal kit, compressor drive shaft. 1959-60 Lark..... **\$75.00 ea.**



1551422 Bracket, side compressor mounting, 1961-64 6-cylinder..... **\$48.00 ea.**

1565393 Bracket, compressor mount. 1965 6-cylinder..... **\$85.00 ea.**

1565906 Bracket, compressor mount. 1966 6-cylinder..... **\$107.50 ea.**

VALVE PLATE KITS

1544975 Valve plate kit, compressor. 1960-61 Hawk..... **\$86.50 ea.**



1551380 Valve plate kit, compressor. 1960-62 Lark & Hawk..... **\$83.50 ea.**



1555482



1550747



This time, if you buy a catalog - You get five dollars off your first purchase.

Offer applies only to first order and after the purchase of a catalog.

ELECTRICAL SECTION GLOSSARY

Headlight Rims, Retainers & Parts.....	192-193	Starters & Related Parts.....	204-205
Taillight Housings, Bezels & Parts	194-195	Generators & Related Parts.....	206
Backup Light & Parking Parts	195	Alternators & Related Parts	207
License Lamp Assemblies & Parts	196	Switches.....	208-209
Lens	196-197	Windshield Wiper Related Parts	210-211
Bulbs.....	197	Power Window	211
Lens Gaskets & Seals.	198-199	Wiring Harnesses.....	212-213
Ignition Related Parts	200-201	Battery Related Parts	213
Distributors & Related Parts.	202-203	Horn Related Parts.....	214

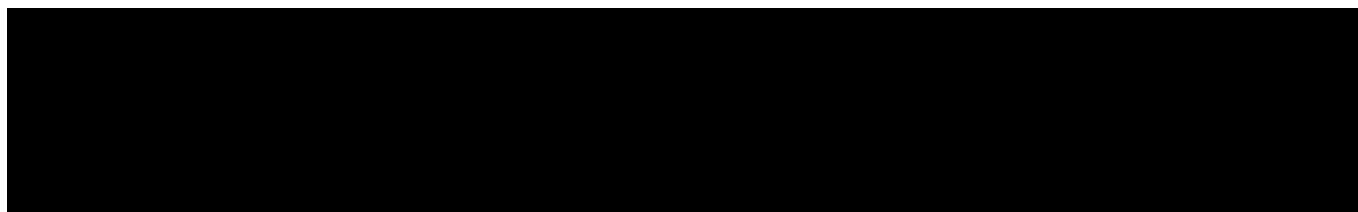

62 Lark Daytona hardtop Mike Berezna of Willowick, OH

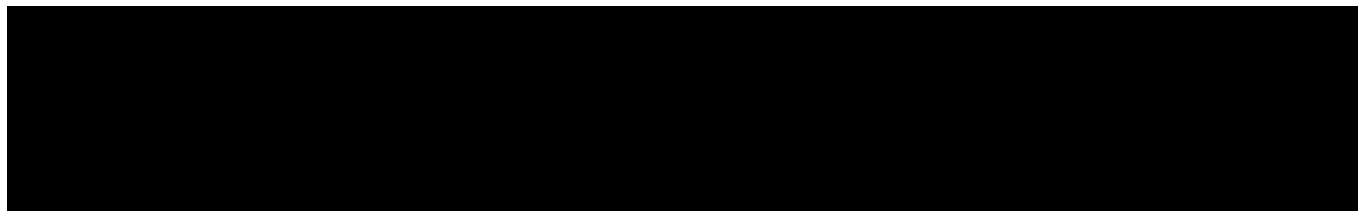

292120 1950
Champion and
1951 All Models.
..... **\$125.00 ea.**



1312088W
1953-55 car, all models
& 1956-62 Hawk.
Retainer bracket
included. **\$123.50 ea.**



1338484 1961 Lark with dual headlight.
NOS. **\$38.00 ea.**



649030
Headlight ring, 1942-48
M-series truck. Chrome.
Includes parking lens gasket
and retainer. **\$99.95 ea.**



1339214
1961 Lark with
single headlight.
NOS.
..... **\$35.00 ea.**

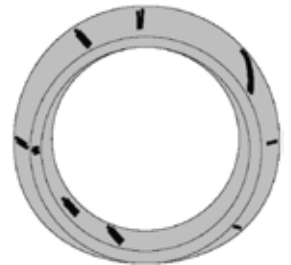

1312089P
Painted headlight rim.
1956-57 Champion &
Commander, 1958
Scotsman. Not
Pictured. . **\$75.00 ea.**



1312089W
Headlight rim.
1956-57 Champion
& Commander, 1958
Scotsman. Chrome ...
..... **\$135.00 ea.**



1314322
Right, headlight
upper moulding.
1956 President.
..... **\$95.00 ea.**



1342465 Right or Left. 1962-63 Lark. NOS.
..... **\$38.00 ea.**

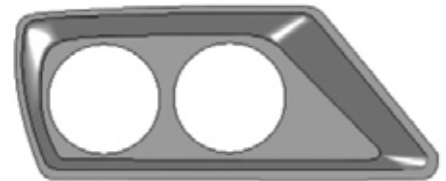

HEADLIGHT RIM KITS



285155X Head light rim kit. 1947-49
Champion. Kit includes (2) 285177 h/l rims, (2)
285197 glass p/l lens & (2) 285181 gaskets.
..... **\$219.00 kit.**

285177 1947-49 Champion H/L rim ONLY
..... **\$99.95 ea.**

652780X Head light rim kit. 1949-53 Truck. Kit
includes (2) 652780 h/l rims, (2) 285197 glass p/l
lens & (2) 285181 gaskets. **\$219.00 kit**

652780 H/L rim ONLY **\$99.95 ea.**



1326172WP Facing, 1958 sedan with single
headlight. Chrome. NOS. **\$75.00 ea.**



1330120P
H/L Filler ring 1958
sedan **\$35.00 ea.**

1331415P 1959-60
Lark. Truck: 1960-64
Champ. Painted. NOS.
..... **\$45.00 ea.**

1331415W 1959-60
Lark. Truck: 1960-64
Champ. Chrome. Pictured
..... **\$95.00 ea.**



1356202 Right. 1964-65 Lark with dual
headlight. NOS. **\$44.00 ea.**

1356203 Left. 1964-65 Lark with dual
headlight. NOS **\$44.00 ea.**

HEADLIGHT RETAINING RINGS

285187 1947-49
Champion, 1951-
54 Champion &
Commander. Truck:
2R-2E all & 3E - 4E 1, 2,
3. **\$22.25 ea.**

285192 1947-57 cars
& 1949-59 trucks
..... **\$12.50 pr.**

1326837 1958-66 with dual headlight. Hall.
Pictured **\$22.25 ea.**

1342945 1961-65 with dual headlight. Hall -
Canada **\$18.00 ea.**

1351891 1961-66 with dual headlight. Hobbs.
..... **\$18.00 ea.**



1356216

Right, 1964 or 66 Lark with single headlight equipment. NOS... \$32.00 ea.



1356217

Left, 1964 or 1966 Lark with single headlight equipment. NOS..... \$32.00 ea.

HEADLIGHT ASSEMBLIES



1326292 Right, 1958 sedan with dual headlight.....\$75.00 ea.

1326293 Left, 1958 sedan with dual headlights.....\$75.00 ea.

1339736 Right, 1961-63 Lark with dual Hall headlight.....\$75.00 ea.

1339737 Left, 1961-63 Lark with dual Hall headlight.....\$75.00 ea.

1351880 Right, 1963 & 1965 Lark with dual Hobbs headlight.....\$65.00 ea.

1351881 Left, 1963 & 1965 Lark with dual Hobbs headlight.....\$65.00 ea.

1360180 Right 1964-65 Lark with dual Hall headlight.....\$65.00 ea.

1360181 Left, 1964-65 with dual Hall headlights.....\$65.00 ea.

1360190 Right, 1964-65 Lark with dual Hobbs headlight.....\$65.00 ea.

1360191 Left, 1964-65 Lark with dual Hobbs headlight.....\$65.00 ea.

1655392 Truck: 5E-8E, models 13, 14, 16, 28, 40, 35, 45 except "96 BBC".....\$100.00 ea.

1656262 Truck: 7E & 8E, models 28, 35, 40, 45 "96 BBC".....\$91.00 ea.

HEADLIGHT

263528 Headlight bulb, 6-volt, (#2331). All 1936-39 car without sealed beam headlight.....\$12.50 ea.

272586 6-volt, 1946-55, all models with sealed beam.....\$20.35 ea.



802343 Provide outstanding lighting and safety. State-of-the-art optics and diode technology provide a crisp beam

with a wider, more even pattern. The solid-state design and rugged construction will last many times longer than a traditional sealed beam. 12-volt only. For sedan (Lark) and Hawk models and Avanti without headlight lens cover....\$325.00 pr.

1326844 Outer, headlight sealed beam. 1958-65 sedan & wagon with D/L.....\$9.00 ea.

1326845 Inner, headlight sealed beam. 1958-65 sedan & wagon with D/L.....\$9.00 ea.

ROUND HEADLIGHT PARTS
1963 AVANTI



1578X34 Speed nut securing ring. Takes 8.....35¢ ea.

1350397 Headlight lens cover gasket.....\$19.00 ea.

1350398 Right, replacement round front headlight lens. Glass.....\$99.95 ea.

1350399 Left, replacement round front headlight lens. Glass.....\$99.95 ea.

1350533W Left outer retainer ring. Chrome...\$149.95 ea.

1350534W Right outer retainer ring. Chrome..\$149.95 ea.

SQUARE HEADLIGHT PARTS
1964-85 AVANTI



1578X34 Speed nut, securing ring. Takes 8.....35¢ ea.

1358786 Headlight lens cover gasket.....\$12.50 ea.

1358787 Headlight housing to body seal.....\$12.50 ea.

1358849 Outer retainer ring. Chrome.....\$150.00 ea.

1358784 Rectangular front headlight lens replacement. Glass.....\$99.95 ea.

HEADLIGHT BEZELS



Rectangular headlight bezel for 1984-89 Avanti. Fiberglass.

1750663 Left.....\$65.00 ea.
1750664 Right.....\$65.00 ea.

HEADLIGHT RELATED PARTS

1523X39 Screw, headlight rim to body. 1963-64 Hawk.....\$2.50 ea.

3305X3 Gasket, headlight rim to body. 1964 Hawk.....\$6.50 ea.

276526 Nut, headlight focusing. 1941-57 car. Truck: 1941-59. Takes 4.....\$4.50 ea.

285187 Sealed beam retainer ring, stainless. 1947-49 Champion, Truck: 1949-59 with standard metal grille.....\$22.25 ea.

285192 1947-57 cars & 1949-59 trucks.....\$12.50 pr.

285974 Headlight focusing screw. 1947-57 car.....\$6.00 ea.

801653 Retainer bracket kit for 1312088W headlight rim. Includes (1) early, (1) late style bracket and screws. Also fits 1963-64 Hawk.....\$5.50 ea.

131026 Grommet for headlight cable. 1934-42 car.....\$4.00 ea.

1326832 Focusing nut & bracket. 1961-63 car with Hall dual headlight equipment.....\$4.25 ea.

1326833 Focusing screw. 1961-63 car with Hall dual headlight equipment.....\$6.00 ea.

1326834 Cable. 1958 car with dual headlight equipment.....\$26.50 ea.

1331432 Cable. 1959-60 Lark. Truck: 1960-64 Champ.....\$20.00 ea.

1338678 Cable. 1961 Lark with single headlight.....\$20.00 ea.

1339735 Cable. 1961-63 Lark with dual headlight.....\$24.00 ea.

1351891 Sealed beam retainer ring, stainless. 1963-66 with Hobbs dual headlight.....\$18.00 ea.

1360198 Cable. 1964-65 car with dual headlight.....\$28.50 ea.

HEADLIGHT BUCKETS & BASES

1326828 Right bucket. 1958 car with dual headlights.....\$52.00 ea.

1326829 Left bucket. 1958 car with dual headlight.....\$52.00 ea.

1338674 Right or left bucket. 1961 Lark with single headlights.....\$52.00 ea.

1339774 Right bucket. 1962-63 Lark with dual Hall headlight.....\$41.50 ea.

1339775 Left bucket. 1962-63 Lark with dual Hall headlights.....\$41.50 ea.

1351885 Inner, left base. 1963-66 Lark with dual Hobbs headlight.....\$16.00 ea.

1351886 Outer, right base. 1963-66 Lark with dual Hobbs headlight.....\$16.00 ea.

1351887 Outer, left base. 1963-66 Lark with dual Hobbs headlight.....\$16.00 ea.

1351888 Right or left bucket. 1963 Lark with dual Hobbs headlight.....\$41.50 ea.

1360195 Right or left bucket. 1964-65 car with dual Hobbs headlight.....\$41.50 ea.

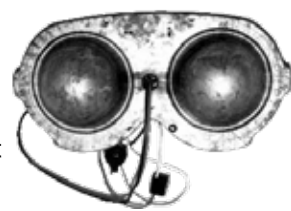

TAIL LIGHT RIMS



289760
Tail light ring, chrome. 1950 Champion. **\$129.95 ea.**

289939
Tail light bezel, chrome. 1950 Commander. Includes reflector. **\$139.95 ea.**



293778X2
Tail light ring, chrome. 1951 Champion and Commander. Includes reflector. **\$179.95 ea.**



1312694 Tail light lens for 1956 Hawk **\$74.00 ea.**

TAIL LIGHT HOUSING & BEZELS

296291W
Tail light bezel. 1952 car. Chrome. **\$160.00 ea.**



298968X2 Right, tail light housing. 1953 sedan. Chrome **\$174.00 ea.**

298969X2 Left, tail light housing. 1953 sedan. Chrome. **\$145.00 ea.**



Bulbs not included.



308227X1 Left, tail light housing. 1955 sedan. Painted **\$162.00 ea.**

308226X2 Right, tail light housing. 1955 sedan. Chrome. **\$195.00 ea.**

308227X2 Left, tail light housing. 1955 sedan. Chrome. **\$234.00 ea.**

300965 Clip, lens retainer for 641311. Takes 3. **\$3.00 ea.**



641311W Same as above (641311) with chrome bezel **\$95.00 ea.**

641311X2 Same as above (641311X1) with chrome bezel **\$95.00 ea.**



1312378 1956 sedan **\$210.00 ea.**

1312676 Right, tail light housing. 1956 station wagon **\$145.00 ea.**

1312677 Left, tail light housing. 1956 station wagon. Pictured left. **\$145.00 ea.**

1323576
Tail light housing. 1957 Scotsman. **\$104.50 ea.**



1326520 Tail light housing base. 1958 Scotsman **\$25.00 ea.**



306076X2 Right, tail light assembly. 1954 sedan & 1954-55 wagon. Chrome **\$195.00 ea.**

306077X2 Left, tail light assembly. 1954 sedan & 1954-55 wagon. Chrome **\$195.00 ea.**

1338884 Right, tail light housing. 1961 Lark **\$45.00 ea.**

1338885 Left, tail light housing. 1961 Lark **\$45.00 ea.**

1343060 Right, tail light housing. 1962 Lark station wagon **\$150.00 ea.**

1343061 Left, tail light housing. 1962 Lark station wagon **\$150.00 ea.**

1353005 Left, tail light assembly. 1963-66 Wagonaire **\$160.00 ea.**

1356250 Right, tail light housing. 1964-65. Painted **\$65.00 ea.**

1356251 Left, tail light housing. 1964-65. Painted **\$65.00 ea.**

1356256 Right bezel, chrome. 1964-65 Lark **\$95.00 ea.**

1361800 Right, tail light housing. 1966 Painted **\$65.00 ea.**

1361801 Left, tail light housing. 1966 Painted **\$65.00 ea.**

1362116 Right painted and chrome bezel. 1966 Lark **\$45.00 ea.**

1362117 Left painted and chrome bezel. 1966 Lark **\$45.00 ea.**

1362118P Right painted bezel. 1966 Lark **\$25.00 ea.**

1362118W Right chrome bezel. 1966 Lark **\$45.00 ea.**

1362119P Left painted bezel. 1966 Lark **\$25.00 ea.**

1362119W Left chrome bezel. 1966 Lark **\$45.00 ea.**



TAIL LIGHT BODIES



1320902 1957-59 Hawk. Complete with socket & cable, & lens gasket **\$65.00 ea.**

1337115 1960-61 Hawk. Complete with socket & cable, & lens gasket. **\$65.00 ea.**

socket & cable, & lens gasket. **\$65.00 ea.**

1952 TAIL LIGHT BODY AND CABLE KIT



Kit Includes:

- 1 - 296363 Body
- 1 - 296365 Cable & socket
- 1 - 293764 Turn signal and stop light bulb

801837 **\$82.50/kit**

BACK-UP LIGHT KITS



AC-2957 Less lens. 1959-61 Lark wagon. **\$85.00 pr.**

AC-3199 Socket & cables. 1962-63 Lark, all **\$12.00 pr.**

AC-3218 Less lens, 1962 Lark wagon **\$90.00 pr.**

AC-3488 Socket & cables. 1964 Lark **\$15.00 pr.**



1963 Avanti R2 owned by Mark Sivek of Henderson, NV

BACK-UP BODIES



1320917 1957-61 Hawk. Complete with socket, cable, & lens gasket **\$60.00 ea.**

1326522 1958 sedan. Complete with socket & cable **\$24.50 ea.**

BACK-UP RETAINERS & BEZELS

1350258 Right, chrome. 1963-89 Avanti **\$35.00 ea.**



1350259 Left, chrome. 1963-89 Avanti **\$35.00 ea.**

1958 sedan. Chrome.



1326502W Right **\$75.00 ea.**

1326503W Left **\$75.00 ea.**

AVANTI CHROME PARKING HOUSING

1358720 1964-83 Avanti. Beautiful chrome reproduction with electrical connector. Includes lens and gasket **\$295.00 ea.**

1959-61 HAWK PARKING LIGHT



A) 1332602 Lens gasket **\$2.00 ea.**

B) 1332601 Lens **\$48.00**

C) 1332600 Chrome ring. **\$25.00 ea.**

D) 1332603 Chrome screw for ring. **\$2.50 ea.**

TAIL LIGHT BRACKET



1685848P Right or left. 1949-62 truck **\$32.50ea.**

SAFETY RUNNING LIGHTS



AC-3522 New cars have it today. Studebaker had it in the sixties. Mounts in center of grille and stays on whenever car is running. NOS **\$25.00 ea.**

LAMP SOCKETS & CABLES

290242 Parking light. 1950 Commander **\$15.00 ea.**

295929 Parking & turn signal light. Late 1952 car. **\$14.00 ea.**

296580 Parking & turn signal light. Early 1952 car. **\$12.00 ea.**

519810 In dash, directional tell-tale light. 1947-49 cars, all. **\$20.00 ea.**

526341 Instrument light. 1950 Champion. **\$15.00 ea.**

526543 In dash, signal light flasher. 1951-52 car, all **\$22.00 ea.**

526549 Directions tell-tale. 1950, all models. **\$26.00 ea.**

526551 Rear turn signal. 1950 car, all **\$27.00 ea.**

1312869 Parking light. 1956 -57 Hawk **\$22.50 ea.**

1326617 Parking light. 1958 Hawk... **\$22.50 ea.**



PARKING/TURN SIGNAL LAMP HOUSING & CABLES

1312966 Right, parking housing. 1956 sedan, not Hawk **\$45.00 ea.**

1312967 Left, parking housing. 1956 sedan, not Hawk **\$45.00 ea.**



1327965 Left, parking & turn light housing. 1958 Packard **\$75.00 ea.**

1338681 Left, parking & turn light housing. 1961 Lark with dual headlight **\$26.00 ea.**

1338690 Parking & turn light housing. 1961 Lark with single headlight **\$26.00 ea.**

1353543 Parking & turn light bezel. 1963 Hawk before V11587 US, VX2295 Canada. Stainless steel **\$18.00 ea.**

1355026 Right, parking housing & cable. 1962-63 Lark. **\$26.00 ea.**

1355027 Left, parking housing and cable. 1962-63 Lark **\$26.00 ea.**

Note: 1964-65 Lark parking light housings originally were die-cast with chrome plating. In 1966 they were aluminum sand-cast and were not plated. These were also used as replacements by the factory for 1964-65 models. We have the following available.

1356220 Right. 1964-66. Sand-cast with new chrome plating **\$95.00 ea.**

1356220X Right. 1964-66. NOS with original chrome plating **\$120.00 ea.**

1356221 Left. 1964-66. Sand-cast with new chrome plating. **\$95.00 ea.**

1356221X Left. 1964-66. NOS with original chrome plating. No Stock

LICENSE LAMP ASSEMBLIES & RELATED PARTS



536458 License lens & gasket. 1955 car all models except station wagon, 1956-64 Hawk. \$15.00 ea.

1331722 Retainer for 1331728 lens. \$12.50 ea.



1332393

License light socket & cable. 1959-61 Lark except station wagon. \$18.50 ea.



1539168 1955 car, all models except station wagon. 1956-64 Hawk. Assembly includes bracket, socket, bulb, lens, gasket and mounting screws. \$45.00 ea.

1539169 1956 2-door station wagon. NOS. \$75.00 ea.

1559770 1962-66 Lark. 1955-56 station wagon. 1959-61 station wagon. 1953-54 all models. 1963-83 Avanti. \$15.00 ea.



ACCESSORY GLOVE BOX LIGHTS



AC-1051 1941-42 Champion & Commander. Truck: M-series. \$45.00 ea.

AC-1433 1947 Champion. \$40.00 ea.

AC-2831 1959-60 Lark. Truck: 1960-64 Champ. \$20.00 ea.

AC-3417 1963 Lark. \$25.00 ea.



Is time running out on your Renovation?

Give us a call!

LENS



LICENSE LENS

285439 1947-49 car, all models. \$8.00 ea.

293050 1951-52 Champion & Commander. \$16.50 ea.

293237 1951-52 Champion W1, F1, C1, Q4. \$12.50 ea.

536458 1955 all, 1956-64 C & K. \$15.00 ea.

1312315 1956 sedan. \$12.50 ea.

1331676 Early 1959 Lark. \$19.50 ea.

1331728 Late 1959 -61 Lark. \$12.50 ea.

1686080 1956-64 C-cab. \$22.85 ea.

BACK-UP LENS



526284 1951-52 car, all. \$65.00 ea.

535299 1954-55 station wagon. \$54.00 ea.

1312389 1956 sedan. \$35.00 ea.

1320363 1957 sedan. \$26.50 ea.

1320924 1957-61 Hawk & 1959-61 Lark. \$30.00 ea.

1326515 1958 sedan. \$20.00 ea.

1342625 1962 Lark. \$30.00 ea.

1343541 1962-64 Hawk. \$24.00 ea.

1343541X1 Amber. 1962-64 Hawk. Export. \$24.00 ea.

1350256 Right. 1963-83 Avanti. \$39.00 ea.

1350257 Left. 1963-83 Avanti. \$39.00 ea.

1353524 Right. 1963-65 wagon. 1966 all. \$30.00 ea.

1356258 Right. 1964-65 Lark. \$16.50 ea.

1356259 Left. 1964-65 Lark. \$16.50 ea.

1541582 1956 Hawk. \$75.00 ea.

TURN SIGNAL LENS



285315 Front, left. 1947-49 Champion. \$25.00 ea.

285394 Rear. 1947-49 Champion. \$12.00 ea.

684584 Front or rear, pedestal mounted. 1955-64 C-cab. \$55.00 ea.

6484470 1957-58 Packard. \$85.00 ea.

TAIL LIGHT LENS

269907 Right, 1939 Commander & President. \$48.00 ea.

269908 Left, 1939 Commander & President. \$48.00 ea.

273537 1940 Commander & President. \$48.00 ea.

282172 Right. 1942-46 Champion. \$38.00 ea.

282173 Left. 1942-46 Champion. \$20.00 ea.

283170 1942 Commander & President. \$22.00 ea.

285393 1947-49 Champion. \$12.00 ea.

285901 1947-49 Commander. \$28.00 ea.

289838 1950 Champion. \$60.00 ea.

289859 1950 Commander. \$60.00 ea.

296313 1952 car, all models. \$60.00 ea.

298960 1953 sedan. \$24.00 ea.

299169 1953-Early 1954 C & K. \$30.00 ea.

300964 Truck: 1937-55. \$22.00 ea.

306715 1954 sedan & 1954-55 station wagon. \$22.00 ea.

306717 1954 C & K. Note: Some 1954 Coupes used '53 tail lights - call if you're uncertain if this pertains to you and we'll check your serial number. \$48.00 ea.

308958 1955 C & K. \$39.95 ea.

308960 1955 sedan. \$60.00 ea.

1312387 1956 sedan. \$95.00 ea.

1312681 1956 wagon. \$25.00 ea.

1312694 1956 Hawk. \$74.00 ea.

1320362 1957 sedan. \$35.00 ea.

1320915 1957-61 Hawk. \$30.00 ea.

1326507 1958 Champion. \$30.00 ea.

1326508 1958 Commander. \$35.00 ea.

1326529 1958 President. \$50.00 ea.

1331774 1959 Lark. \$45.00 ea.

1336251 1960 Lark. \$45.00 ea.

1342630 1962 4-door wagon. \$22.00 ea.

1342662 1962 Lark. \$65.00 ea.

1343540 1962-64 Hawk. \$40.00 ea.

1350256X1 Right center. 1983-88 Avanti. \$32.00 ea.

1350257X1 Left center. 1983-88 Avanti. \$32.00 ea.

1350294 Right 1963-91 Avanti. \$75.00 ea.

1350295 Left 1963-91 Avanti. \$75.00 ea.

1352436 Right. 1963-66 wagon. \$20.00 ea.

1352437 Left. 1963-66 wagon. \$20.00 ea.

1353620 1963 Lark, except station wagon. \$65.00 ea.

1356264 Right. 1964 Lark. \$16.50 ea.

1356265 Left. 1964 Lark. \$16.50 ea.

1361050 Right. 1965 Lark. \$16.50 ea.

1361051 Left. 1965 Lark. \$16.50 ea.

1361806 Right. 1966 Lark. \$16.50 ea.

1361807 Left. 1966 Lark. \$16.50 ea.

1656113 Truck: 1961-64 Champ with wide box. \$42.50 ea.

1686084 Truck: 1956-62 all except wide bed truck. \$18.00 ea.

6484470 1956-58 Packard. \$45.00 ea.



FRONT PARKING LIGHT LENS

- 272610** 1939 with sealed beam head lights & 1940 all..... **\$25.00 ea.**
- 281618** 1941 Commander & President fender light..... **\$45.00 ea.**
- 285197** 1947-49 Champion. Truck: 1949-53 2R..... **\$22.00 ea.**
- 285914** 1947-49 Commander..... **\$22.00 ea.**
- 289739** 1950 Commander..... **\$30.00 ea.**
- 295930** Early 1952 car, all models... **\$20.00 ea.**
- 296175** Late 1952 Champion & Commander. **\$20.00 ea.**
- 297572** Right. 1953-54 car, all models..... **\$55.50 ea.**
- 297573** Left. 1953-54 car, all models. NOS..... **\$55.50 ea.**
- 308098** Right. 1955 car, all models . **\$35.00 ea.**
- 308099** Left. 1955 car, all models.... **\$35.00 ea.**
- 1312666** 1956 sedan..... **\$18.00 ea.**
- 1312867** 1956-58 Hawk..... **\$15.00 ea.**
- 1323138** 1957 Packard..... **\$48.50 ea.**
- 1332328** Right. 1959 Lark..... **\$12.00 ea.**
- 1332329** Left. 1959 Lark..... **\$12.00 ea.**
- 1336222** Right. 1960 Lark..... **\$12.00 ea.**
- 1336223** Left. 1960 Lark..... **\$12.00 ea.**
- 1338684** Right. 1961-62 Lark..... **\$22.00 ea.**
- 1338685** Left. 1961-62 Lark..... **\$54.37 ea.**

- 1338692** 1961 Lark with single headlights..... **\$15.00 ea.**
- 1350106X1** Outer with chrome ring. 1963 Avanti..... **\$50.99 ea.**
- 1350108** Amber inner P/L 1963 Avanti..... **\$39.00 ea.**
- 1353388** Right. 1963 Lark..... **\$20.00 ea.**
- 1353389** Left. 1963 Lark..... **\$20.00 ea.**
- 1353542** Amber. Early 1963 Hawk... **\$18.00 ea.**
- 1356226** Right, clear. 1964-66 Lark **\$40.00 ea.**
- 1356227** Left, clear. 1964-66 Lark.. **\$40.00 ea.**
- 1356762** Clear. Late 1963-64 Hawk **\$25.00 ea.**
- 1358722** Clear. 1964 Avanti..... **\$46.00 ea.**
- 1360694** Right, amber. 1964-66 Lark..... **\$45.00 ea.**
- 1360695** Left, amber. 1964-66 Lark **\$52.00 ea.**
- 1360697** Amber. 1964-83 Avanti.... **\$35.00 ea.**
- 1654081** Truck: 1956 2-E..... **\$42.00 ea.**
- 1655024** Truck: 1958-64 Transtar ... **\$47.75 ea.**
- 1656356** Right, amber. Truck: 1960-64 Champ..... **\$15.00 ea.**
- 1656357** Left, amber. Truck: 1960-64 Champ. Pictured..... **\$15.00 ea.**
- 1657751** Zip van..... **\$15.00 ea.**

BULBS



6-VOLT

- 110527** Parking light, without directional signals. 1934 Dictator, Commander, President. 1950-55 all models. License light. 1938-55 all models..... **\$1.75 ea.**
- 185368** Parking light, without directional signals. 1935-46 all models. 1937-55 all models. 1947-49 Champion. Truck: M-series. Dashboard light. Clear..... **\$1.75 ea.**
- 186547** Tail light. 1934-50 all models. Parking light, with directional signals. 1951-55 all models. Truck: M-series 2R-E, all models #1158..... **\$3.90 ea.**
- 188659** 1934-55 Instrument turn signal and high beam dash indicator..... **\$1.50 ea.**
- 281149** Dome light. 1947-55 all models. Truck: 2R-E. #88..... **\$2.00 ea.**
- 282012** Backup, 1947-52 All..... **\$3.75 ea.**
- 293764** Tail light. 1951-55 all models #1154..... **\$2.85 ea.**
- 523439** Accessory spotlight, back-up. All models, without sealed beam. 1953-55..... **\$9.90 ea.**

12-VOLT

- 1557882** Dashboard light, red. #57, large. All models with red bulb & 1963-85 Avanti..... **\$1.60 ea.**
- 1557883** Dashboard light, red. #53, small. All models with red bulb & 1963-85 Avanti..... **\$1.60 ea.**
- 1358200** Front amber parking bulb for Avanti with clear lens equipment..... **\$2.00 ea.**
- G127934** Dashboard light, clear. #57..... **\$1.05 ea.**
- G142450** License light. 1956-66 car & 1963-85 Avanti..... **\$2.00 ea.**
- G142456** Back-up light. 1956-66 car & 1963-85 Avanti..... **\$2.00 ea.**
- G454645** Tail light. 1956-66 car & 1963-85 Avanti. Parking light. 1956-66 car & 1963-85 Avanti..... **\$1.50 ea.**
- G454646** Backup. 1956-1957 car all except 1957 C & K. Also used on 1958 Scotsman..... **\$2.00 ea.**
- G455136** Dome light. 1956-66 car & 1963-85 Avanti..... **\$2.00 ea.**
- G131282** Dashboard light, clear. #53..... **\$1.25 ea.**

REFLECTOR



- 289886** 1951-52 tail light bezel..... **\$3.95 ea.**
- 1320364** Jewel tail light reflector 1957 sedan..... **\$5.00 ea.**

FRONT FENDER SPEAR ASSEMBLY PARTS FOR 1962-64 HAWK

- 1355125W** Hawk front moulding. 1962-64 Hawk, top of front fender retainer for plastic spear. Chrome..... **\$40.00 ea.**
- 1353851** Seal, spear to moulding..... **\$2.10 ea.**
- 1343590** Front fender plastic spear insert 1962 Hawk..... **\$20.00 ea.**
- 1353324** Front fender plastic spear insert. 1963-64 Hawk..... **\$20.00 ea.**
- 1353741** 1963-64 Hawk socket cable and bulb.. **\$18.00 ea.**
- 1353850** Seal. 1962-64 Hawk. Moulding to body..... **\$3.00 ea.**

- 1353655** Lower metal cover. 1963-64 Hawk..... **\$16.50 ea.**
- 1353661** Seal, under fender light assembly. **\$3.00 ea.**

FRONT SPEAR ASSEMBLY KIT

- Kit for 1963-64 Hawk. Includes:
- 2 1355125W..... Chrome spear
- 2 1353850..... Moulding to body seal
- 2 1353851..... Lens seal
- 2 1353324..... Plastic spear
- 2 1353741..... Socket cable and bulb
- 2 1353655..... Lower cover
- 2 1353661..... Housing seal
- Total if parts were purchased separately..... \$205.00**
- 801857**
- Special Kit Price..... \$184.50 pr.**

LENS GASKETS & HOUSING SEALS

PARKING LENS GASKETS & SEALS

- 274472** Parking light lens gasket. 1942-48 M-series truck..... **\$2.00 ea.**
- 285181** Parking light lens gasket. 1947-49 Champion. Truck: 2R & 57-59 Scotsman truck..... **\$2.00 ea.**
- 289731** Parking light lens gasket. 1950 Champion & 1951 Champion & Commander..... **\$7.50 ea.**
- 297774** Parking light lens gasket. 1953-54 car, all models..... **\$2.00 ea.**
- 309349** Parking light lens gasket. 1955 car, all models..... **\$2.00 ea.**
- 1312797** Parking light lens gasket. 1956 sedan..... **\$2.00 ea.**
- 1312868** Parking light lens gasket. 1956-58 Hawk..... **\$3.50 ea.**
- 1320089** Parking light lens gasket. 1957-58 sedan..... **\$5.75 ea.**
- 1323137** Parking light lens gasket. 1957 Packard..... **\$2.00 ea.**
- 1331554** Parking light lens gasket. 1959-60 Lark. Truck 1960-64 Champ..... **\$2.00 ea.**
- 1332602** Parking light lens gasket. 1959-61 Hawk..... **\$2.00 ea.**
- 1338686** Parking light lens gasket. 1961-63 Lark and 1962 Hawk..... **\$2.00 ea.**
- 1338693** Parking light lens gasket. 1961 Lark with single head lights..... **\$3.25 ea.**
- 1350107** Parking light lens gasket. 1963 Avanti..... **\$2.00 ea.**
- 1353544** Parking light lens gasket. Early 1963 Hawk..... **\$2.00 ea.**
- 1353545** Parking light bezel seal. Early 1963 Hawk..... **\$3.00 ea.**
- 1355021** Parking light lens gasket. Late 1963-64 Hawk..... **\$2.00 ea.**
- 1356228** Parking light lens gasket. 1964-66 Lark..... **\$2.00 ea.**
- 1358715** Parking light housing to body seal. 1964-83 Avanti..... **\$2.50 ea.**
- 1358716** Parking light lens gasket. 1964-83 Avanti..... **\$2.70 ea.**

LENS SCREW KITS

- 800287** 1963-85 Avanti. Chrome screws for headlight ring, parking light & back-up light..... **\$5.00 set**
- 800288** 1962-64 Hawk. Includes parking, tail and back up. 12 chrome plated screws..... **\$5.00 set**
- 801349** 1953 car. Parking light & tail light..... **\$3.50 set**
- 801350** 1954 car. Parking light & tail light..... **\$3.50 set**
- 801351** 1955 car. Parking light & tail light..... **\$3.50 set**



TAIL LIGHT LENS & BODY GASKETS & SEALS

- 3096X2** Tail light housing to body gasket. 1959-60 Lark..... **\$4.45 ea.**
- 3096X5** Tail light housing to body gasket. 1962 wagon..... **\$3.00 ea.**
- 3096X7** Tail light housing to body gasket. 1962-64 Hawk..... **\$8.00 set/4**
- 271284** Tail light lens seal. 1939-40 Champion..... **\$5.00 ea.**
- 287022** Tail light to fender seal. 1947-49 Champion..... **\$4.50 ea.**
- 287068** Tail light to fender seal. 1947-49 Commander..... **\$4.50 ea.**
- 289885** Tail light to fender. 1950 car. All models..... **\$4.00 ea.**
- 293338** Tail light lens seal. 1951..... **\$11.50 ea.**
- 299170** Tail light lens seal. 1953 C & K..... **\$2.00 ea.**
- 306055** Tail light lens seal. 1954 C & K. Note: Some 1954 Coupes used 53 tail lights - call if you're uncertain if this pertains to you and we'll check your serial number..... **\$2.00 ea.**
- 308957** Tail light lens seal. 1955-56 C & K..... **\$2.00 ea.**
- 802234** Tail light lens seal. 1950 and 1952 Champion & Commander..... **\$4.50 ea.**
- 1312391** Tail light lens seal. 1956 sedan..... **\$5.75 ea.**
- 1320361** Tail light body to housing gasket. 1957 sedan..... **\$9.50 ea.**
- 1320916** Tail light lens seal. 1957-61 Hawk..... **\$2.00 ea.**
- 1326518** Tail light lens. 1958 sedan..... **\$2.00 ea.**
- 1331426** Round tail light cable seal to body. 1959-60 Lark..... **\$2.00 ea.**
- 1331429** Tail light lens. 1959-60 Lark..... **\$2.00 ea.**
- 1338883** Tail light housing and lens to body. 1961 Lark..... **\$4.00 ea.**
- 1342665** Tail light lens seal, 1962-63 Lark..... **\$3.00 ea.**
- 1343064** Tail light lens seal. 1962 4-door station wagon..... **\$2.00 ea.**
- 1343065** Seal, tail light cable to body. 1962 wagon..... **\$2.00 ea.**
- 1343456** Tail light housing to body gasket. 1962-63 Lark..... **\$3.50 ea.**
- 1343543** Tail light lens seal. 1962-64 Hawk..... **\$2.00 ea.**
- 1350296** Tail light lens seal. 1963-88 Avanti..... **\$2.00 ea.**
- 1350768** Tail light housing seal. Avanti..... **\$4.50 ea.**
- 1352438** Tail light lens seal. 1963-66 station wagon..... **\$2.00 ea.**
- 1355041** Tail light housing gasket. 1963-66 station wagon..... **\$4.50 ea.**
- 1356262** Tail light lens seal. 1964-65 Lark..... **\$5.50 ea.**
- 1356263** Tail light housing gasket. 1964-65 Lark..... **\$4.00 ea.**
- 1361804** Tail light housing gasket. 1966 Lark..... **\$4.00 ea.**



HEADLIGHT BODY GASKETS & SEALS

- 3305X3** Headlight rim to body. 1964 Hawk..... **\$6.50 ea.**
- 272617** Headlight to rim. 1939-41 car with sealed beam. Truck: early M-series..... **\$12.00 ea.**
- 285196** Headlight to fender. 1947-49 Champion. Truck: 1949-54 & 57-59 w/metal grille... **\$6.00 ea.**
- 285968** Headlight to fender. 1947-49 Commander 1953-66 car, with single Headlight equipment. Truck: 1960-64 Champ & 57-64 with fiberglass grille..... **\$6.00 ea.**
- 289638** Headlight to fender. 1950 Champion. 1951 car, all models..... **\$7.60 ea.**
- 289639** Headlight to fender. 1950 Commander..... **\$6.00 ea.**
- 296275** Headlight to fender. 1952 car, all models..... **\$7.60 ea.**
- 648761** Headlight to fender. 1941-46 car, all models. Truck: M-series..... **\$13.50 ea.**

BACK-UP LENS & BODY GASKETS & SEALS

- 3096X4** Backup housing to body seal. 1959-61 Lark. 1962 Lark 2-dr. wagon..... **\$2.00 ea.**
- 3096X6** Backup housing to body seal. 1962 Lark 4-dr. wagon..... **\$2.00 ea.**
- 3161X3** Backup housing to body & lens seal. 1962 Lark..... **\$3.50 ea.**
- 3161X5** Backup housing to body & lens seal. 1966 all models & 1963-65 wagon..... **\$3.50 ea.**
- 535071X2** Backup housing to body seal. 1953-55..... **\$3.00 ea.**
- 1312390** Backup lens seal. 1956 sedan..... **\$5.75 ea.**
- 1320775** Backup lens seal. 1957-61 Hawk, 1959-61 Lark..... **\$2.50 ea.**
- 1326516** Backup lens seal. 1958 sedan..... **\$2.00 ea.**
- 1342627** Backup light housing to body seal. 1962 Lark..... **\$2.00 ea.**
- 1343542** Backup lens seal. 1962-64 Hawk..... **\$2.00 ea.**
- 1350260** Backup lens seal. 1963-90 Avanti..... **\$2.50 ea.**
- 1353170** Backup lens seal. 1963 Lark..... **\$2.00 ea.**
- 1353275** Backup housing to body seal. 1963 Lark..... **\$3.00 ea.**

LICENSE LENS SEALS

- 534195** License lens seal. 1953-54 car, all models. 1962-66 Lark. 1963-83 Avanti..... **15¢ ea.**
- 1331677** 1959-61 Lark..... **\$3.00 ea.**

1953 Coupe & Hardtop

297572	Parking light lens, right.....	\$55.50
297573	Parking light lens, left.....	\$55.50
297774	Parking light lens gasket (2).....	\$2.00
299169	Tail light lens (2).....	\$30.00
299170	Tail light lens gasket (2).....	\$2.00
801349	License screw kit.....	\$3.50
1559770	License light assembly, (2).....	\$15.00

Total of all parts if purchased separately.....
.....**\$208.40**

801614

Special package price.....**\$185.00 ea.**

1954 Coupe & Hardtop

297572	Parking light lens, right.....	\$55.50
297573	Parking light lens, left.....	\$55.50
297774	Parking light lens gasket (2).....	\$2.00
306055	Tail light lens gasket (2).....	\$2.00
306717	Tail light lens (2).....	\$48.00
801350	License screw kit.....	\$3.50
1559770	License light assembly (2).....	\$15.00

Total of all parts if purchased separately.....
.....**\$254.50**

801615

Special package price.....**\$230.00 ea.**

Note: Some 1954 Coupes used 1953 tail lights - call if you're uncertain if this pertains to you and we'll check your serial number. Plus, we'll adjust this price if it does.

1955 Coupe & Hardtop

308098	Parking light lens, right.....	\$35.00
308099	Parking light lens, left.....	\$35.00
308957	Tail light lens gasket (2).....	\$2.00
308958	Tail light lens (2).....	\$39.95
309349	Parking light lens gasket (2).....	\$2.00
536458	License lens.....	\$15.00
801351	License screw kit.....	\$3.50

Total of all parts if purchased separately.....
.....**\$176.40**

801616

Special package price.....**\$162.00 ea.**

1956 Hawk

308957	Tail light lens gasket (2).....	\$2.00
536458	License lens.....	\$15.00
1312694	Tail light lens (2).....	\$74.00
1312867	Parking light lens (2).....	\$15.00
1312868	Parking light lens gasket (2)....	\$3.50

Total of all parts if purchased separately.....
.....**\$176.00**

801617

Special package price.....**\$160.00 ea.**

1957-58 Hawk

536458	License lens.....	\$15.00
1312867	Parking light lens (2).....	\$15.00
1312868	Parking light lens gasket (2)....	\$3.50
1320775	Back up lens gasket (2).....	\$2.50
1320915	Tail light lens (2).....	\$30.00
1320916	Tail light lens gasket (2).....	\$2.00
1320924	Back up lens (2).....	\$30.00

Total of all parts if purchased separately.....
.....**\$181.00**

801618

Special package price.....**\$160.00 ea.**

1959-61 Hawk

536458	License lens.....	\$15.00
1332601	Parking light lens (2).....	\$48.00
1332602	Parking light lens gasket (2).....	\$2.00
1320775	Back up lens gasket (2).....	\$2.50
1320915	Tail light lens (2).....	\$30.00
1320916	Tail light lens gasket (2).....	\$2.00
1320924	Back up lens (2).....	\$30.00

Total of all parts if purchased separately.....
.....**\$244.00**

801619

Special package price.....**\$220.00 ea.**

1962 Hawk

536458	License lens.....	\$15.00
800288	License screw kit.....	\$5.00
1338686	Parking light lens gasket (2).....	\$2.00
1343540	Tail light lens (2).....	\$40.00
1343541	Back up lens (2).....	\$24.00
1343542	Back up lens gasket (2).....	\$2.00
1343543	Tail light lens gasket (2).....	\$2.00

Total of all parts if purchased separately.....
.....**\$160.00**

801620

Special package price.....**\$145.00 ea.**

Early 1963 Hawk

536458	License lens.....	\$15.00
800288	License screw kit.....	\$5.00
1343540	Tail light lens (2).....	\$40.00
1343541	Back up lens (2).....	\$24.00
1343542	Back up lens gasket (2).....	\$2.00
1343543	Tail light lens gasket (2).....	\$2.00
1353542	Parking light lens (2).....	\$18.00
1353544	Parking light lens gasket (2).....	\$2.00

Total of all parts if purchased separately.....
.....**\$196.00**

801621

Special package price.....**\$175.00 ea.**

Late 1963 Hawk

536458	License lens.....	\$15.00
800288	License screw kit.....	\$5.00
1343540	Tail light lens (2).....	\$40.00
1343541	Back up lens (2).....	\$24.00
1343542	Back up lens gasket (2).....	\$2.00
1343543	Tail light lens gasket (2).....	\$2.00
1356762	Parking light lens, clear (2).....	\$25.00
1355021	Parking light lens gasket (2).....	\$2.00 ea.

Total of all parts if purchased separately.....
.....**\$210.00**

801622

Special package price.....**\$190.00 ea.**

1964 Hawk

536458	License lens.....	\$15.00
800288	License screw kit.....	\$5.00
1343540	Tail light lens (2).....	\$40.00
1343541	Back up lens (2).....	\$24.00
1343542	Back up lens gasket (2).....	\$2.00
1343543	Tail light lens gasket (2).....	\$2.00
1356762	Parking light lens (2).....	\$25.00
1355021	Parking light lens gasket (2).....	\$2.00 ea.

Total of all parts if purchased separately.....
.....**\$210.00**

801623

Special package price.....**\$190.00 ea.**



IGNITION

COILS for 6-cylinder Engines



519977 1942 with IGC distributor. 1946-55 car. Truck: M5, M15, M15A, M17 & 2R-E- 5, 10, 11, 15, 16, 17 **\$46.50 ea.***

533064 1933-42 car, except 1942 with IGC distributor. Not used with original ignition switch & setup **\$46.50 ea.**

1549377 1956-61 car. Truck: 2E-6E 1, 5, 10..... **\$43.65 ea.**

1553539 1961-64 except 1961 Lark with IGN042 distributor. Truck: 2E 6, 11, 14 & 4E 1, 5 & 3E-4E 3, 6, 11, 14, 16, 17 & 6E 5, 10. NOS..... **\$30.90 ea.**

1553636 1965-66 car without trans ignition. New production..... **\$30.90 ea.**

***Note: not for vehicles with old style ignition switch and cable.**

COILS for 8-cylinder Engines

533064 1951-55 car. Truck: 3R-E 7, 12, 13, 28, 40..... **\$46.50 ea.**

1553539 1962-64 car & 1963-64 Avanti. 1956 Golden Hawk. Truck: 7E-8E 7, 12, 13, 28, 40. NOS..... **\$30.90 ea.**

1553636 1956-61 car except 1956 Golden Hawk. 1965-66 car. Truck: 2E-5E 2, 7, 12, 13, 28, 38, 40 & 6E 7, 12, 13, 28, 40. New production..... **\$30.90 ea.**

1565264 1964-66 car, with Trans Igniter ignition. **\$25.50 ea.**



COIL RESISTORS & RELATED PARTS

439553 Resistor, primary coil, 1956-57 V-8 all except Packard **\$35.00 ea.**

1540269 Cable, coil to primary resistor, 1963-64 Lark & Hawk with R-1 or R-2 engines also 1963-64 Avanti. **\$15.50 ea.**

1550327 Resistor wire, ignition to coil. 1960 Lark and Hawk..... **\$15.50 ea.**

1550556 Resistor, R-2 Avanti after serial #5280. Also 1961 6-cylinder Lark & 1961-62 6-cylinder truck. NOS **\$12.80 ea.**

1558482 Resistor. 1963-64 R-2 Lark and Hawk before engine #V-6760. 1963-64 Avanti before serial number 5280. **\$35.00 ea.**

1559977 Cable, ignition switch to coil primary resistor. 1963 Lark and Hawk with R-1 or R-2..... **\$15.50 ea.**

1561493 Cable, ignition switch to coil primary resistor. 1964 Lark and Hawk with R-1 or R-2..... **\$15.50 ea.**

6484685 Resistor used with coil 1553636. **\$19.50 ea.**

IGNITION SHIELDING 1963-65 Avanti

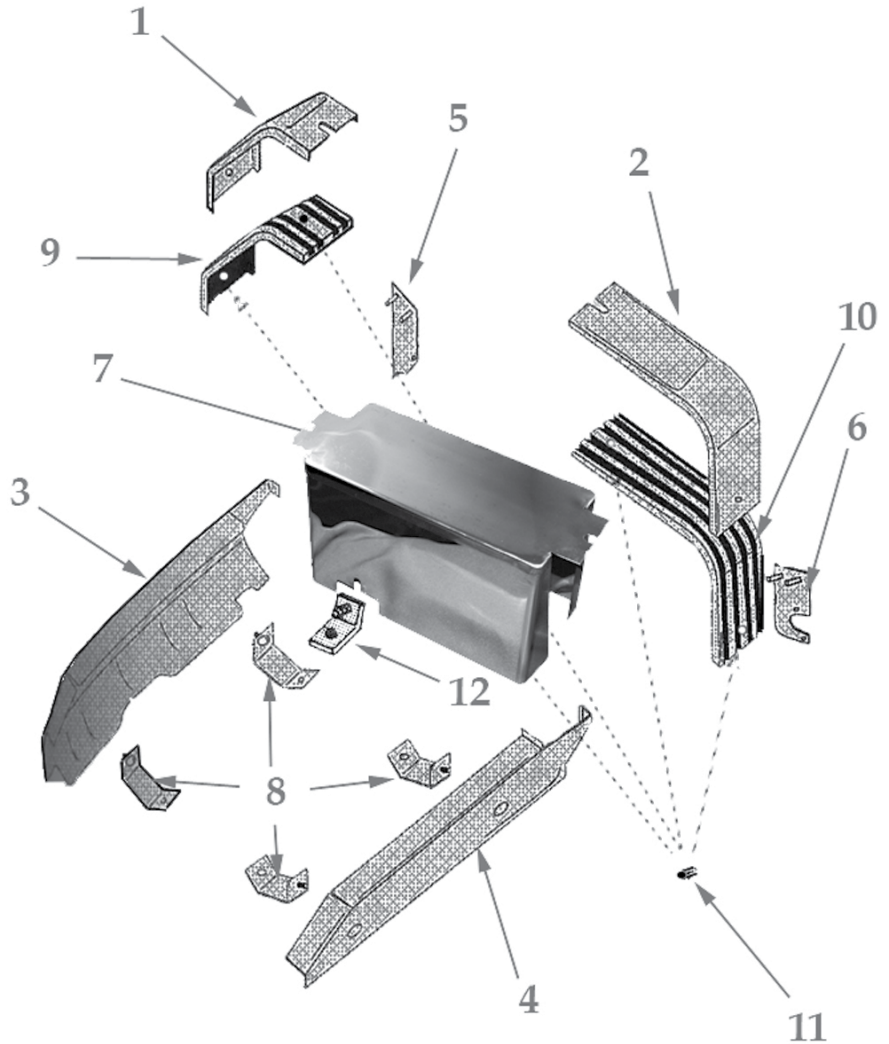

All stainless ignition shielding except for the center distributor cover are NOS. Many years of shelf wear have left some pieces in less than show worthy condition. You can polish the stainless to return its bright and scratch free appearance.

- (1) **1557227** Right, plug wire cover..... **\$30.00 ea.**
- (2) **1557226** Left, plug wire cover..... **\$30.00 ea.**
- (3) **1556944** Right, spark plug cover..... **\$30.00 ea.**
- (4) **1556941** Left, spark plug cover..... **\$75.00 ea.**
- (5) **1557723** Right, bracket to head..... **\$22.50 ea.**
- (7) **1556936** Distributor cover..... **\$119.95 ea.**
- (8) **1556947** Plug cover bracket..... **\$18.00 ea.**
- (9) **1557569** Right, plug wire insulator..... No Stock
- (10) **1557568** Left, plug wire insulator..... No Stock
- (11) **1557658** Spacer. Takes 4 **\$1.50 ea.**
- (12) **1557660** Bracket for distributor cover **\$8.50 ea.**

MOUNTING NUT

Chrome



519987 1947-50 Champion. Chrome mounting nut for ignition switch. **\$20.00 ea.**

IGNITION SHIELDING ACORN NUTS



1-102 Ignition shielding acorn nuts. 1963-64 Avanti. 8 nuts, 8 washers..... **\$16.50 set**

IGNITION SWITCH ASSEMBLY

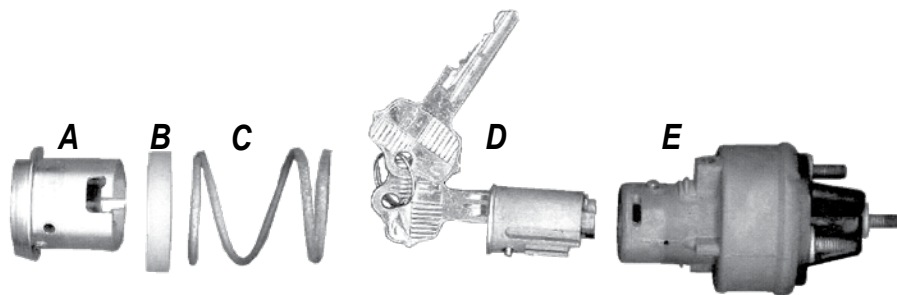

- A) **532501W** Bezel. 1953-54 car, all models NOS. , and all 1955 trucks..... **\$22.20 ea.**
 *A) **1544684W** Bezel, does not have "start" imprinted.*1955-59 car, all models. Truck: 1955-59 **\$29.15 ea.***
 *A) **1549685W** Bezel, used with 1549705 switch. 1960-66 car, all models & 1963-70 Avanti. Truck: 1960-64, all models..... **\$29.15 ea.***
 B) **1544987** Ignition lock spacer. 1956-64, all models & 1963-70 Avanti **\$12.00 ea.**
 C) **532502** Spring. 1953-54 car, all models **\$6.60 ea.**
 C) **536125** Spring, ignition switch tension. 1958 Scotsman **\$6.00 ea.**
 C) **1546371** Spring, ignition switch tension. 1955-66 car, all models & 1963-70 Avanti. **\$5.50 ea.**
 D) **1555547** Ignition lock & keys. 1947-66 car, all models with Yale switch & 1963-70 Avanti. Truck: 1955-64, all models. This lock fits inside 1549705 switch. Includes 2 keys..... **\$22.50 ea.**
 E) **1549705** Ignition switch with 1555547 lock. 1955-66 car & truck. Lock comes with 2 1960-63 style keys. Lock is removable and can be replaced with your original lock and keys or can be re-keyed (by your locksmith) to match your doors. Switch is identical to original and accommodates twist-on style bezel..... **\$85.00 ea.**

***NOTE: This reproduction bezel is made of aluminum and is much stronger than the original. This is an important safety item as the original bezels frequently broke, allowing the switch to become loose and short circuit. Replace your bezel before this happens!**

SWITCHES WITHOUT CYLINDER & KEYS

(Switch only)

- 521050** 1951-52 Commander & 2R series truck. Switch only. Hurd lock..... **\$60.00 ea.**
526396 1950 Commander & Land Cruiser with standard trans. Ignition switch only. Hurd lock..... **\$50.00 ea.**

NOTE: We have a limited quantity of additional ignition switches, please inquire. (317) 462-3124

IGNITION KEYS

- 525810** 1947-59 models with Yale lock. Same key should operate both ignition & doors..... **\$8.00 pr.**

- 525931** 1947-60 models with Hurd lock. Same key should operate both ignition & doors. **\$8.00 pr.**

NOTE: This key is easily identified because the shaft is quite short.

- 1555550** 1960-63 all models including Avanti. Same key should operate both ignition & doors **\$8.00 pr.**

IGNITION SWITCH TUMBLER WITH KEYS

- 520460** Hurd switch tumbler with keys for some M-series trucks **\$54.00 ea.**

Trunk keys can be found on pages 133-134.

Glove box keys can be found on page 40.

- 1561741** 1964-66 all models & 1964-70 Avanti. Same key should operate both ignition and doors. **\$8.00 pr.**

- 801542** Deluxe ignition & door key blank for all 1947-63 models with Yale locks. Beautiful gold finish with crest logo **\$7.95 ea.**

- 801543** Deluxe ignition & door key. All 1947-60 models with Hurd locks. Hurd keys have a very small shaft. Beautiful gold finish with crest logo **\$7.95 ea.**

IGNITION CABLE SETS COPPER CORE WIRE

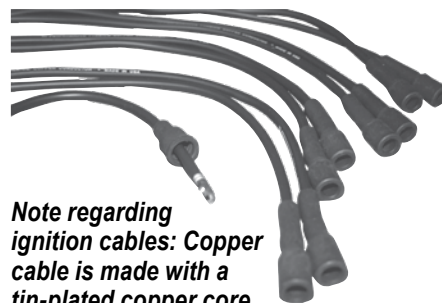

Note regarding ignition cables: Copper cable is made with a tin-plated copper core, EPDM insulation with an EPDM jacket. This is very similar to what was in the car when new. Silicone cable is made with a CHT core (Aramid fiber with a conductive latex covering with a conductive silicone cover), EDPM insulation, with a silicone jacket. Silicone cable will not be as easily damaged by exhaust manifold or engine heat and also reduces radio static.

- 1555534** 1961-64 Lark 6-cylinder. Truck: 6E-8E 5, 10 **\$47.25 set**

***Note: Except coil wire on pre-war car.**

www.studebaker-intl.com

SILICONE WIRE

Black Packard Cable

- 800854** 1939-60 Champion. Truck: M5, M15, M15A & 2R-5E 5, 10, 15 **\$59.50 set**
800855 1961-64 Lark 6-cylinder. Truck: 6E-8E, 5, 10 **\$59.50 ea.**
800856 1951-54 V-8 car, all models **\$78.75 ea.**
800857 1955-58 V-8 car, all models except 1956 Golden Hawk Truck: 1955-58 V-8..... **\$83.25 ea.**
800858 1959-64 V-8 car, all models. Truck: 4E-8E 2, 7, 12,13, 28, 38, 40 **\$78.75 ea.**
800867 1963-64 Avanti **\$89.25 ea.**
800954 1947-50 Commander. Truck: 2E-3E 6, 11, 14, 16,17. May work on earlier vehicles except for distributor to coil wire..... **\$59.50 ea.**

IGNITION CABLE BRACKET

- 1539892** 1956-64 V-8, all models. **\$20.00 ea.**
1564741 Rear upper left. 1965-66 V-8. **\$12.00 ea.**



DISTRIBUTOR

REBUILT



802189 Most models available. Must have rebuildable old Distributor first. Call (317) 462-3124 for availability and price.

NOS DISTRIBUTORS

1564269 Distributor. 1965-66 V-8. Used before engine numbers 20556913 & 805566913.....
\$230.00 ea.

1565703 Distributor. 1966 230 6-cylinder. Used before engine number 715214668 \$195.00 ea.

1565731 Distributor. 1966 230 6-cylinder. Used after engine number 715214668 \$195.00 ea.

1565732 Distributor. 1966 V-8. Used after engine numbers 20556913 & 805566913
\$230.00 ea.

DISTRIBUTOR SEALS (to Block)

510131 Distributor seal. 1934-64 6-cylinder..... \$1.40 ea.

527214 Distributor seal. 1951-52 V-8..... \$1.00 ea.

533010 Distributor seal. 1953-64 V-8 & 1963-64 Avanti \$1.35 ea.

1564114 Distributor. 1965-66 6-cylinder... 50¢ ea.

1564271 Distributor. 1965-66 V-8 50¢ ea.

CAPS FOR 6 CYLINDER ENGINES

125917 With Delco distributor. 1950 Commander & 1959 Lark. Truck: 2R-2E, 6, 11, 14, 16, 17 & 4E 1, 5 & 3E-5E 3, 6, 11, 14, 16, 17, 28 & 29 Dictator & Commander 6-cyl. (see note T-4) \$21.50 ea.

173254 1929-34 Studebaker & Dictator 6 with Delco Remy distributor..... \$30.00 ea.

182271 With Autolite IGW distributor. 1934-41 Dictator, Commander, Coupe Express. 1939-41 Champion. Truck: M5, 15, 15A, 16, 17. (see note T-5)..... \$60.50 ea.

527340 With Autolite IAT distributor. Late 1950 Champion. Truck: 2R 5, 10, 15. (see note 2 & T-2) \$39.90 ea.

530225 With Autolite distributor 1951-64 Champion & Lark. Truck: 2R-2E 5, 10, 15 & 3E-8E 1, 5, 10. (see note T-1) \$21.00 ea.

667658 With Autolite IGC distributor 1942-49 Commander. 1942 - early 1950 Champion. Truck: M5, 15A 16, 17 & 2R 5, 10, 15, 16, 17. (see note 1 & T-3)..... \$45.00 ea.

1565154 1965-66 Lark with Delco distributor... \$13.75 ea.

NOTE 1: Type with spark modifier mounted under base. Used on model 1950 Champion before engine #531,285.

NOTE 2: Type with spark modifier mounted on side of base. Used on & after engine numbers in note 1.

NOTE T-1: Type with spark modifier mounted in side of base. Used on & after 2R5-2R10: 1R-94,733; 2R15; 2R-12,058.

NOTE T-2: Type with spark modifier mounted on side of base. Used on engine numbers 2R5-2R10: 1R-51,666 to 1R-84,733; 2R15: 2R-0,371 to 2R-12,058.

NOTE T-3: Type with spark modified mounted under base. Used before engine number 2R5-2R10: 1R-51,666; 2R15: 2R-10,371. Used on M5-M17 on and after engine numbers in T-5.

NOTE T-4: Delco Remy equipment. Used on and after engine 2R16A-2R17A: R-20,907.

NOTE T-5: Used before engine number M5: 1M-8, 566; M5-M15A: 2M-7,795; M16-M17: 3M-13,488.

NOTE T-6: Used on and after trucks listed in note T-7.

NOTE T-7: Used before truck serial 4E2: E2-674; 4E7: E7-12,136; 4E12-4,167; 4E13-3,093.

Tune-Up with Kits to Save Money!

TUNE-UP KITS

Kit Includes:

- Ignition cable set (Black silicone Packard cable)
- Distributor cap
- Points
- Rotor
- Condenser
- Spark plugs

<p>1951-64 Champion 6-cylinder with Autolite Distributor Total of all parts if purchased separately..... \$155.25 ea</p> <p>801030R Special Package Price.....\$147.00/kit</p>	<p>1962-64 V- 8 all models, except Avanti. Prestolite Total of all parts if purchased separately..... \$209.20 ea.</p> <p>801033R Special Package Price..... \$198.00/kit</p>
<p>1951-59 V- 8 all models except 1956 Golden Hawk & 1960-61 Hawk Delco Total of all parts if purchased separately..... \$226.05 ea.</p> <p>801031R Special Package Price..... \$214.00/kit</p>	<p>1963-64 Avanti R-1 or R-2. Prestolite Total of all parts if purchased separately..... \$214.85 ea.</p> <p>801034R Special Package Price..... \$204.00/kit</p>
<p>1960-61 Lark V-8 all models with Delco window type Total of all parts if purchased separately..... \$198.90 ea</p> <p>801032R Special Package Price..... \$188.00/kit</p>	<p>1965-66 6 cylinder Kit Includes: Points, rotor & condenser only. 1565290 \$14.95/kit</p> <p>Note: When ordering specify year and model of car, No substitutions or deletions.</p>

ELECTRONIC DISTRIBUTOR KIT



Excludes Avanti and Packard engines.

802449 All 1951-64 V-8 except Avanti and Packard engines. 12-volt only. Must use coil supplied with distributor. Comes with new distributor and coil. Includes installation instructions
\$271.95 ea.

CAPS FOR 8 CYLINDER ENGINES

458563 1956 Golden Hawk. Autolite distributor. \$52.00 ea.

530937 1951-59 car, all models. 1960-61 Hawk. Truck: 3R-2E, 7, 12, 13, 28, 38 & 3E-5E 2, 7, 12, 13, 28, 38, 40. With Delco distributor (see note T-7)..... \$23.55 ea.

1550272 1960-61 Lark & 1965-66 Lark. Truck: 4E-6E 2, 7, 12, 13, 28, 40. With Delco window type distributor (see note T-6) \$25.50 ea.

1555503 1962-64 car, all models & 1963-64 Avanti. Truck: 7E-8E 7, 12, 13, 28, 40. With Prestolite distributor \$28.90 ea.



SPARK PLUGS



FOR 6-CYLINDER ENGINES

AC-88 1933-40 car. Truck: M16. \$4.90 ea.

419918 1941-60 car. Truck: 1948-60 \$3.60 ea.

1550554 1961-64 car. Truck: 1961-64 \$5.10 ea.

FOR 8-CYLINDER ENGINES

AC-88 1933-40 car, straight 8..... \$3.60 ea.

439771 1956 Golden Hawk \$4.00 ea.

1550554 1951-64 car except 1956 Golden Hawk. Truck: 1955-64..... \$3.60 ea.

1559195 1963-64, all models including Avanti with jet thrust engine. 1965-66 Lark \$3.60 ea.

DISTRIBUTOR PARTS

516196 Dis-distributor weights. 1947-64, all with Prestolite or Autolite distributor. Set of 2 with brass bushings.....



\$50.30 pr.

526893 Vacuum advance. 1950 Commander. Truck: Late 2R-6E 3, 6, 11, 14, 16, 17.....

\$45.00 ea.

527341 Vacuum advance. Late 1950-60 Champion 6-cylinder.....

\$95.00 ea.

527351 Cable, distributor contact arm, with modifier on side of base. Late 1950-54 Champion & 2R-2E 5 & 10 truck.....

\$9.00 ea.

527352 Cable, distributor contact arm, with modifier below base. Late 1950-54 Champion & 2R-2E 5 & 10 truck.....

\$5.30 ea.

531759 Spring set. Late 1951- all 1952 car and 1959-61 V-8.....

\$14.40 pr.

1549387 1960-64 6-cylinder. Cable to coil.....

\$12.00 ea.

1564652 Vacuum advance. 1966 6-cylinder.....

\$32.00 ea.

1564653 Distributor vacuum advance. 1965-66 V-8.....

\$45.00 ea.

1565135 Distributor vacuum advance. 1965 6-cylinder.....

\$32.00 ea.

1558290 Distributor vacuum advance 1963-64 Lark, Hawk, and Avanti with R1- R2 engines Prestolite, Nors.....

\$125.00 ea.

6484249 Autolite distributor vacuum advance. 1956 Golden Hawk. NOS.....

\$125.00 ea.

Searching for Studebaker parts?

You are in the right place! Studebaker International is the largest supplier of new-old stock and reproduction Studebaker auto parts.

CONDENSERS



FOR 6-CYLINDER ENGINES

175967 1934-41 car. Truck: M5, M15, M15A, M16, M17. With Autolite IGW distributor (see note

T-3).....

\$14.80 ea.

193804 1934 & 1936 Dictator and 1934-40 Straight 8's. With Delco distributor.....

\$14.05 ea.

661926 1950 Commander. 1959 Lark or 1965-66 Lark. Truck: 2R-5E all except 5, 10, 15. 1928-29 Dictator & Commander. With Delco distributor (see note T1).....

\$12.50 ea.

1555506 With Autolite distributor, 1942-64 car. Truck: M5, M15A, 16, 17 & 2R-8E. (see note T-2).....

\$7.90 ea.

NOTE T-1: Delco Remy Equipment. Used on and after engine #: 2R16A-2R17A: 4R20,907.

NOTE T-2: Used on and after engine #: M5: 1M-8,566 and M15-M15A: 2M-7,795 and M16-M17: 3M-13,488.

NOTE T-3: Used before engine numbers in note T-2.

POINTS

FOR 6-CYLINDER ENGINES



194031 1930-34 model "Studebaker", 1934 & 1936 Dictator all with Delco Remy distributor.....

\$35.00 ea.

194035 1934-35 Dictator with Autolite distributor.....

\$16.00 ea.

194036 With Autolite IGW distributor 1936-41 car and M5-M17 truck. (see note T-1).....

\$19.70 ea.

526985 With Delco distributor. 1950 Commander. 1959 Lark or Hawk. Truck: 4E 1, 5 & 2R-5E 3, 6, 11, 14, 16, 17.....

\$17.50 ea.

1548446 1959-64 car and 4E-6E 1, 5, 10 & 7E-8E 1, 5, 10 truck with Autolite distributor.....

\$22.15 ea.

1550501 With Autolite distributor. 1942-59 car. Truck: M5, M15A-M17 & 2R-3E 5, 10, 15, 16, 17 & 3E 1, 5, 10. (see note T-2).....

\$16.60 ea.

1564676 1965-66 car with Delco distributor.

\$11.15 ea.

FOR 8-CYLINDER ENGINES

513653 1941-42 Presidents (dual points).....

\$22.00 pr.



1544167 With Delco distributor 1951-59 car, 1960-61 Hawk. Truck: 2R-4E 2, 7, 12, 13, 28, 38, 40 ..

\$20.00 ea.

1548446 With Prestolite distributor 1962-64 car. Truck: 7E-8E 7, 12, 13, 28, 40.....

\$12.50 ea.

1550286 With Delco window type distributor 1960-61 Lark. 1965-66 Lark.....

\$28.05 ea.

1560473 With Prestolite dual point distributor, 1963-64 with Avanti jet thrust R1 or R-2 engine; 1956 Golden Hawk.....

\$29.30 pr.

NOTE T-1: Used before engine numbers: M5 1M-8,566. M15-M15A: 2M-7,795. M16-M17: 3M-13,488.

NOTE T-2: Used on and after engine numbers in note T-1.

FOR 8-CYLINDER ENGINES

513655 1941 President.....

\$12.00 ea.

516206 1942 President.....

\$12.00 ea.

661926 1951-59 car, all models; 1960-61 Hawk and 2R-5E truck with Delco distributor.

\$10.10 ea.

1550279 1960-61 and 1965-66 Lark. Truck: 4E-6E 2, 7, 12, 13, 28, 40. With Delco window type distributor.....

\$16.55 ea.

1555506 1962-64 Lark or Hawk with single pointed distributor, 1956 Golden Hawk (458578). Truck: 7E 4 12, 13, 28, 40. With Prestolite distributor.....

\$14.00 ea.

1560358 1963-64 Avanti or Larks & Hawks with R-1 or R-2 engines. NOS.....

\$14.00 ea.

ROTORS

FOR 6-CYLINDER ENGINES



125920 1928-29 Dictator & Commander.....

\$35.00 ea.

131569 1929-36 car with Delco distributor.....

\$33.30 ea.

189113 1934-41 car. Truck: M5, 15, 15A, 16, 17. With Autolite IGW distributor (see note T-4).....

\$18.50 ea.

513654 1941-42 President.....

\$35.00 ea.

527328 Late 1950 Champion. With Autolite IAT distributor. Truck: 2R 5, 10, 15 (see note 1 & T-2).....

\$13.70 ea.

530226 1951-64 Champion and Lark. Truck: 2R-2E 5, 10, 15 & 3E-6E 1, 5, 10, & 4E-5E 1, 5 & 7E-8E 5, 10. With Autolite distributor (see note T-1).....

\$9.50 ea.

635267 1950 Commander, 1959 Lark or Hawk. Truck: 2R-5E 3, 6, 11, 14, 16, 17 & 4E 1, 5. With Delco distributor.....

\$11.00 ea.

905826 1942-49 Commander. 1942-early 50 Champion. Truck: Late M5, 15A, 16, 17, & 2R 5, 10, 15, 16, 17 (see note 2 & T-3). With Autolite IGC Distributor.....

\$14.40 ea.

1565138 1965-66 Lark. With Delco distributor.....

\$4.25 ea.

FOR 8-CYLINDER ENGINES

371245 1956 Golden Hawk with Autolite distributor.....

\$20.80 ea.

533942 1951-59 car, all models & 1960-61 Hawk. Truck: 3R-3E & 4E 2, 7, 12, 13, 28, 38, 40. With Delco distributor. (see note T-6).....

\$28.00 ea.

1555502 1962-64 V-8 car, all models & 1963-64 Avanti. Truck: 7E-8E 7, 12, 13, 28, 40. With Prestolite distributor.....

\$10.50 ea.

1564662 1960-61 Lark & 1965-66 Lark. Truck: 4E-6E 2, 7, 12, 13, 28, 40. With Delco window type distributor (see T-5).....

\$9.25 ea.

NOTE 1: Used on 1950 Champion with Autolite IAT distributor (spark modifier on side of base) on & after engine #531, 285.

NOTE 2: Used on 1950 Champion with Autolite IGC distributor (spark modifier under base) before engine #531,285.

NOTE T-1: Type with spark modifier mounted on side of base. Used on trucks after engine #2R5-2R10: 1R-94,732, 2R15: 2R-10,371.

NOTE T-2: Use with Autolite distributor with spark modified mounted on side of base. Engine # 2R5-2R10: 1R-51,666 to 1R-94,733, 2R15: 2R10,371 to 2R-10,371 to 2R-12058.

NOTE T-3: For M5, M15, M15A, M16, M17. Used on and after engine numbers M5: 1M-8566; M15-M15A: 2M-7795; M16-M17: 3M-13,488. For 2R5, 2R10, 2R15, 2R16, 2R17. Type with spark modifier mounted under base. Used on models with engine numbers before 2R5-2R10: 1R-51,666; 2R15: 2R-10,371; 2R16A-2R17A,4R-20907 with Autolite.

NOTE T-4: Used on M5, M15, M15A, M16, M17 before engine number: M5: 1M-8566; M15-M15A: 2M-7795; M16-M17: 3M-13488.

NOTE T-5: Used on and after truck serials: 4E2: E2-674; 4E7: E7-12,136; 4E12-4,167; 4E13: E13-3,093; 4E28: E28-6,659; 4E40: E40-3,120.

NOTE T-6: Used on trucks before serial in note T-5.

STARTER



REBUILT STARTERS

801206R Professionally rebuilt to operate as new, (armature & bendix not included in normal rebuild)..... **\$255.00 ea.**

Must have old Rebuildable starter first.

STARTER MOTOR ARMATURES



188620 Autolite armature. 1936 Dictator, late 1937 Dictator and 1938-42 Commander..... **\$90.00 ea.**

188626 Autolite armature. 1936 Dictator with and late 1937-42 Dictator, Commander & Coupe Express. Also early M16 & 17 truck **\$90.00 ea.**

190461 Armature, early 1937 Dictator & 1941-42 President 8..... **\$110.00 ea.**

197310 Armature, starter. 1939 Champion early- M2 4066..... **\$75.00 ea.**

521885 Armature. 1947-55 cars with Champion 6-cylinder engine **\$90.00 ea.**

522067 Armature. 1947-49 Commander 6-cylinder cars & early 2R16 & 17 truck..... **\$94.00 ea.**

526875 Armature. 1950 Commander cars, late 2R-series trucks and all 3R (1954) and E-series (1955) truck. All with Commander 6-cylinder engine. Also used on 1951-55 V-8 car & truck with V-8 engine **\$90.00 ea.**

1540776 Armature, 1956-60 6-cylinder. **\$75.00 ea.**

1540826 Armature, 1956-58 V-8 **\$75.00 ea.**

1550795 Armature. Late 1960 and all 1961-64 170 6-cyl cars and 1962-64 Champ 6-cylinder truck with automatic transmission..... **\$95.00 ea.**

1552709 Armature, Delco. 1961 V-8..... **\$75.00 ea.**

Note: We have access to additional armatures not featured here. Please inquire.

STARTER BENDIX DRIVE SPRING

521889 1950-55 Champion **\$4.95 ea.**

STARTER SOLENOIDS

191939 1938-50 Commander, 1947-54 Champion **\$75.00 ea.**



530039 Dash mounted. 1951-54 Commander. **\$31.45 ea.**

536124 Dash mounted. 1955 Commander & President..... **\$32.00 ea.**



1539452 Starter mounted. 1956-58 Champion. Truck: 2E 5, 6, 10, 11, 14 & 3E 5, 6, 11, 14, 16. Pictured, left..... **\$79.00 ea.**

1539716 1956-58 Commander & President. 1959-64 car, all models & 1963-64 Avanti. Truck: 3E-6E all models & 7E-8E 5, 7, 10, 12, 13, 28, 40 **\$21.80 ea.**

1564897 1965-66 car, all models & 1966-85 Avanti..... **\$27.00 ea.**

STARTER SWITCHES

195948 Aftermarket, 1939-46 Champion & 1941-42 Commander. Truck: M5-M17 all models & 2R, 3R, E. Floor mounted..... **\$29.00 ea.**

513183 1953-54 Champion with auto transmission on dash **\$33.60 ea.**

519829 1947-1954 car, floor mounted..... **\$67.20 ea.**

527663 1950-51 car with automatic transmission on dash..... **\$25.00 ea.**

531716 1952 with automatic transmission on dash..... **\$33.60 ea.**

532135 1953 Commander with auto transmission on dash. **\$33.60 ea.**

665190 1941-55 truck. NOS. **\$29.00 ea.**



BRUSHES & SPRINGS



123577 Brush set. 1928-33 car, 1934-36 Dictator. 1934-35 Commander. 1934-40 President & 1951-55 V-8. Truck: All with Delco starter. **\$15.75 set/4**

176203 Spring for Autolite brushes. 1934-64 all 6-cylinder, 1962-64 V-8 car, all models & 1963-64 Avanti. Truck: 3E, 5E-8E 5, 10 & 7E-8E 7, 12, 13, 28, 40..... **\$13.90 ea.**

176226 & 524262 (2 ea.) Autolite brush set. 1934-35 Dictator & 1939-46 Champion **\$22.00 set/4**

188622 & 524262 (2 ea.) Brush set. 1936-42 Commander Coupe Express & 1941-42 President 8..... **\$18.50 set/4**

197307 Brush set for Autolite starter. 1939-55 Champion. Truck: M5, M15, M15A & 2R-E 5, 10, 15 Includes 4 - **524262**..... **\$24.00 set/4**

458873 Brush set. 1956-61 V-8 & 1965-66 car. Truck: 2E-6E all except 5, 10 & 4E 1, 5. With Delco starter **\$9.00 set/4**

458874 Spring for brushes. 1956-61 V-8. 1959 6-cylinder, 1965-66 car, all models. Truck: 2E-6E, all models except 5, 10. With Delco starter..... **\$12.25 set/2**

801358 Brush set. 1936-42 Commander, Dictator, Coupe Express & 1941-42 President 8. 2 each - **188622 & 188623** **\$22.00 set/4**

1540774 Brush set, Autolite starter. 1956-59 6-cylinder car..... **\$24.00 set/4**

1550789 Brush set, Prestolite starter. 1960-64 6-cylinder, 1962-64 V-8 car, all models & 1963-64 Avanti. Truck: 5E-6E 5, 10, & 7E-8E 5, 7, 10, 12, 13, 28, 40..... **\$15.20 set/4**

STARTER DRIVES

Remanufactured



Note: Due to a limited supply of cores, your old one must be received first, or a \$100.00 deposit will be charged.

6484191 1956 Golden Hawk **\$35.00 Ex.**

STARTER DRIVES

New

188628 1936-42 Dictator, Commander, Coupe Express & 1936 President **\$105.00 ea.**

190426 1937-40 President..... **\$65.75 ea.**

197313 1939-46 Champion with Autolite starter. Truck: M5, M15, M15A, & 2R-2E 5, 10, 15, 3R & 3E-7E 1, 5, 10. **\$97.25 Ex.**

511488 1934-35 all models..... **\$105.00 ea.**

521888 1947-55 all models. Truck: M16, M17 & 2R-E except 5, 10, 15 **\$97.25 ea.**

1540831 1956-60 6-cylinder & 1956-61 V-8 car with Delco starter. Truck: 4E 1, 5 & 2E-5E 3, 6, 11, 14, 16, 17 & 2E-6E 2, 7, 12, 13, 28, 38 **\$106.20 ea.**

1550373 1960-64 6-cylinder & 1961-64 V-8 car & 1963-64 Avanti. Truck: 7E-8E 5, 7, 10, 12, 13, 28, 40 **\$97.25 ea.**

1564648 1965-66 car & 1966-77 Avanti. **\$25.00 ea.**

STARTER MOTOR REBUILD KITS

Kit Includes:

- Commutator end plate & bushing
- Brush set
- Springs
- Intermediate bearing
- Nose bushing. Where applicable.

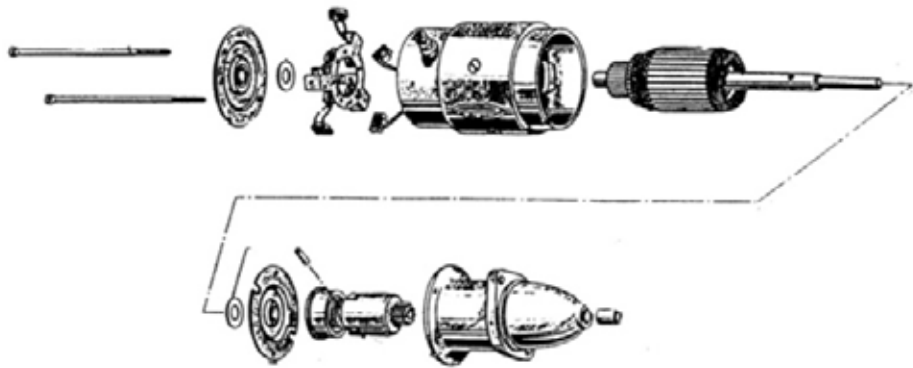

1938 Commander
tag #AL-MAW-4015
191929X1\$80.00/kit

1941-42 Commander & Early M16 & M17 Truck
tag #AL-MAW-4020
199954X1\$80.00/kit

Late **1939 & all 1940-46 Champion & Champion Trucks 1941-55**
tag #AL-MZ-4074 or 4090 - excludes front plate
512863X1\$60.00/kit

1947 Champion tag #4136
519135X1\$60.00/kit

1948-55 Champion
tag #MZ-4151 or 4157 excludes commutator end plate & brush springs
526214X1\$55.00/kit

1950-55 Commander, 1949-55 Commander 6 Truck, Late 2R16 & 17's, all 3R & E 16 & 17 Truck & 1954-55 V-8 Truck
531608X1\$80.00/kit

1947-49 Commander, Late M16 & M17 Truck, Early 2R16 & 17 Trucks
Vehicles with 226 engine and tag #MCH-4001
676714X1\$80.00/kit

1956-61 Commander 6 & V-8 Truck, 4E Champion Truck with Delco Remy equipment, & All **1956-61 V-8 Cars Also 1959 6-Cyl Cars** with Delco Remy equipment
1539580X1\$80.00/kit

1956-58 Champion Car
1539582X1\$80.00/kit

1959 & Early 1960 6-cylinder car (Autolite)
1549019X1\$80.00/kit

STARTER BUSHINGS, PINIONS & BEARINGS

131971 Bushing, Bendix drive housing. 1936 Dictator. 1936-40 President. 1951-55 V-8. Truck: 2R-E. With Delco starter.....**\$6.25 ea.**

171777 Center bearing. All 1934 cars with Delco Remy starter.....**\$26.40 ea.**

171780 Bushing, Bendix drive housing. 1928-35. With Delco starter.....**\$6.00 ea.**

176208 Bushing, Bendix drive housing. 1947-55 Champion. With Autolite starter.....**\$5.50 ea.**

197320 Pinion & barrel, Bendix. 1939-46 Champion.....**\$22.00 ea.**

511728 Bushing, Bendix drive housing. 1934-37 Dictator. 1938-49 Commander. 1941-42 President. 1937-39 Coupe Express. Truck: M16, M17 & 2R 16, 17. With Autolite starter.....**\$7.75 ea.**

1540779 Bushing, Bendix drive housing. 1956 Golden Hawk. 1956-64 6-cylinder, 1962-64 V-8 car, all models & 1963-64 Avanti. Truck: 7E-8E 5, 7, 10, 12, 13, 28, 40 with Autolite starter.....**\$4.50 ea.**

1540830 Bushing, Bendix drive housing. 1956-61 V-8, 1959 6-cylinder, 1965-66 car, all models. Truck: 2E-6E with Delco starter.....**\$5.50 ea.**



Studebaker INTL.
111 Aiken St., Hope IN 47246
(317) 462-3124

Gift Certificate

Good for the purchases to the value of \$ _____

TO: _____

FROM: _____

X _____
This certificate is invalid and void without an Authorized Signature

Studebaker Gift Certificates

Always a Great Idea!
Available in any Amount!

No Expiration Date!

GENERATOR

REBUILT

801207R Professionally rebuilt to operate as new. \$199.00 Ex.

NOTE: We must have your old rebuildable generator first.



ADJUSTING ARMS with Generators



- 529369** 1951-57 V-8 \$18.00 ea.
- 1539782P** 1956-64 6-cylinder. \$12.50 ea.
- 1545940** 1958-64 V-8 without air conditioning. \$25.00 ea.
- 1546014** 1959-64 V-8 with air conditioning. \$35.00 ea.

GENERATOR BRUSH SETS (Standard Equipment Only)

191921 1934 Dictator 6 AL- GAR-4609A & 1935-36 Dictator with Autolite. 1937 Dictator & Coupe Express with AL-GBM-4604A OR 4607A. \$25.00 pr.



191922 1937 Dictator or Coupe Express with Autolite AL-GCM-480ZA generator. Also 1939-40 Champion \$12.10 pr.

195058 1934 Dictator 6 with Delco Remy generator \$25.00 pr.

195059 1936 Dictator & 1934-36 President with Delco Remy equipment. \$31.00 pr.

199035 1940 President. \$31.00 pr.

526812 1950 Commander. 1951-61 V-8. 1959 6-cylinder. Truck: 2R-2E all except 1, 5, 15. With Delco Remy generator. Takes 2. \$8.35 pr.

527487 Brushes. 1939-51 Champion & 1939-49 Commander with Autolite generator. \$23.00 pr.



531647 Brush spring. 1952-61 V-8 with Delco generator. \$6.05 pr.

537829 1939-40 Commander, Coupe Express & 1941-42 President 8 \$18.00 pr.

1550801 For Autolite generator. 1951-62 6-cylinder, 1956 Golden Hawk, & 1962 V-8 car, all models. Truck: 3E-6E 1, 5, 10 & 7E-8E 5, 7, 10, 12, 13, 28, 40 \$19.45 pr.

GENERATOR OVERHAUL KITS

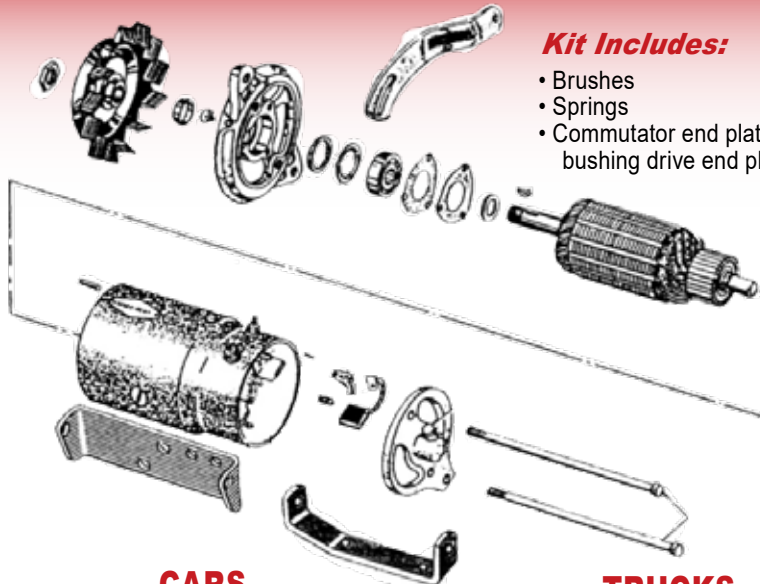

Kit Includes:

- Brushes
- Springs
- Commutator end plate with bushing drive end plate bearing

CARS

- 512574X1** 1941-50 Champion. GDZ 4804A. \$80.00 kit
- 512575X1** 1941-49 Commander 6 GDZ 4805A \$80.00 kit
- 526682X1** Late 1950 Champion. GDZ 6001A. \$80.00 kit
- 526683X1** 1950 Commander. \$80.00 kit
- 531385X1** 1951 Commander. \$80.00 kit
- 531635X1** 1952-54 Commander. Includes insulated brush holder kits. \$80.00 kit
- 531705X1** 1951-55 Champion. \$80.00 kit
- 1540825X1** Autolite. 1956-58 Champion & 1959-early 60's 6-cylinder. \$80.00 kit
- 1541275X1** 1955-58 V-8 except with air conditioning & power steering, 1959 6-cylinder & V-8 with Delco Remy generator. \$80.00 kit
- 1550351X1** All 1960 V-8 & early 1961 V-8. \$80.00 kit
- 1550372X1** Late 1960 & all 1961 6-cylinder. Autolite. \$80.00 kit
- 1553181X1** Late 1961 V-8. \$80.00 kit
- 1555236X1** 1962 car, all models. \$80.00 kit

TRUCKS

- 512574X1** 1941-48 M5 & M15 & early 2R5-10-15 GDZ4804A. \$80.00 kit
- 512575X1** 1941-48 M16 & M17 & early 2R 16 & 17 GDZ4805A. \$80.00 kit
- 531635X1** All 1949-55 Commander 6 truck, V-8 & late 2R 16 & 17 truck. \$80.00 kit
- 531705X1** Late 2R5 thru 1955 Champion truck GDZ6001 A/6001S. \$80.00 kit
- 1540825X1** Autolite. 1956 Champion 6-cyl P.U. also 1957-59. \$80.00 kit
- 1541275X1** All 1956 trucks except Champion 6 & 1959 Champion 6 with Delco Remy, 1957-59 Commander V-8. \$80.00 kit
- 1550351X1** 1960 Champion 1/2 ton 6-cylinder \$80.00 kit
- 1550372X1** 1960-61 Champion 6-cylinder \$80.00 kit
- 1553181X1** 1961 Commander 6 & V-8. \$80.00 kit
- 1555236X1** Autolite. 1962-64 all with single belt equipment. \$80.00 kit
- 1695105X1** 1962-64 trucks models 7-12-13-28-40 with dual belt equipment. \$80.00 kit
- 1695129X1** 1962-64 trucks models 15-25-35-45. Excludes commutator end plate. \$80.00 kit

GENERATOR DRIVE END BEARING

526868 Drive end bearing. 1934-62 car, all models. Truck: All models with generator.....
.....\$20.00 ea.



GENERATOR ARMATURES



458828 1956-58 V-8 except car with power steering and air conditioning.....\$130.00 ea.
530934 Armature, 1951 V-8.....\$151.25 ea.
531641 Armature, 1953-55 V-8.....\$115.25 ea.
531760 1952-55 Champion.....\$125.00 ea.
680896 Truck: 2R 6, 11, 14, 16, 17.....
.....\$125.00 ea.
1540762 1956 Golden Hawk. 1956-62 6-cylinder, 1961-62 V-8.....\$135.00 ea.
1546798 1958 Champion.....\$115.00 ea.
1552759 1960-63 Auto-Lite 40 AMP.....
.....\$235.00 ea.

VOLTAGE REGULATORS



513615 Late 1940-50 Commander, 1940-49 President, & 1941-48

M-series truck (not used on vehicles with low speed cut-in or Hi-output equipment)
.....\$105.40 ea.
530227 1950 Commander. 1951-55 V-8 car with Delco generator. Truck: 2R 6, 11, 14, 16, 17 & 3R-E all except 5, 10, 15.....\$116.85 ea.
530272 1951 Champion. NOS.....\$94.00 ea.
531703 1952-55 6-cylinder car with Autolite generator. Truck: 2R & E 5, 10, 15 with 45 amp generator.....\$212.00 ea.
1539451 1956-early 60 6-cylinder & 1956 Golden Hawk with Autolite generator. Truck: 1957-59 3E, 4E 1, 5, 10.....\$140.00 ea.
1539579 1956-61 V-8 car with Delco generator. Truck: 4E 1, 5 & 3E, 4E all except 1, 5, 10 & 5E all except 5. NOS.....\$155.00 ea.
1550091 1960-61 6-cylinder Lark with GJP7102C generator. Truck: 5E, 6E 5, 10. NOS...
.....\$105.40 ea.
1555237 1962 6-cyl and V-8 car with Autolite generator. Truck: 7E, 8E 5, 7, 10, 12, 13, 28, 40 NOS.....\$82.45 ea.
1556952 1963-64 Avanti. (Replacement).....
.....\$350.00 Exch.
***1558528** 1963-66 car, all models except Avanti, with alternator.....\$23.70 ea.

***Note: These regulators are electronic replacements that look similar to original manufactured ones.**

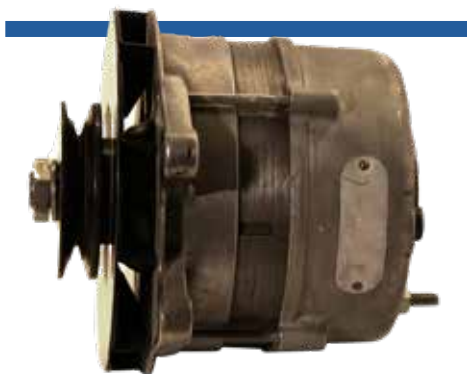

ALTERNATOR

REBUILT

801208R Professionally rebuilt to operate as new. To order we must have the number from the manufacturer tag on your old alternator & the year, model & engine of your car\$199.00 ea.

NOTE: Because of a shortage of cores we must have your old rebuildable alternator first.

ALTERNATOR PARTS

(35-AMP) 1963-65 Car & Truck: 8E

1558002 Brush set, all models.\$25.00 ea.
1558009 Drive end bearing. All models.
.....\$10.90 ea.
1558014 Bearing, slip ring end head. All models.....\$12.60 ea.
1558015 Rectifier, positive. Takes 3.....
.....\$16.00 ea.
1558016 Rectifier, negative. Takes 3.....
.....\$16.00 ea.
1559795 Rotor and slip ring. All models.....
.....\$180.00 ea.
1559797 Head, drive end.....\$60.00 ea.
1559798 Stator. All models.....\$115.00 ea.
1559799 Head slip ring end.....\$90.00 ea.

AVANTI R1-R2 & 1963-65 CARS

With 40-AMP Alternator
Everything same as 35 amp alternator except as follows:

1558008 Head, alternator drive end. All.....
.....\$135.00 ea.
1558010 Stator. All.....\$138.00 ea.

PRESTOLITE & DELCO TAGS



distributor, starter. 1962-64 all models including Avanti.....\$12.00 ea.

800206

Prestolite tag for alternator, distributor, starter. 1962-64 all models including Avanti.....\$12.00 ea.



801109 Delco tag for generator, starter & distributor. 6-volt. Black.....\$12.00 ea.



801110 Delco tag for generator, starter & distributor. 12-volt. Red.....\$12.00 ea.

DISCOUNTS

We appreciate customers making large purchases and offer the following special discounts:

Purchase total over **\$750.00** 10%
\$1,500.00 15%

TURN SIGNAL SWITCHES & RELATED PARTS

- 526544** 6-volt flasher, 1950-54 car, all models. Truck: 1951-55..... **\$12.00 ea.**
- 533519** Switch & cables. All 1953- early 1960 car except 1956 Golden Hawk with automatic transmission. Truck: 1956 V-8 with class-B turn signals & automatic trans. Some 1961 & all 1962-64 truck with 4-speed transmission. Also, 1-ton & larger 1962-64 truck **\$73.50 ea.**
- 533522** Spring shift coil tension. 1953-54 car. **\$1.80 ea.**
- 533627** Switch plate. 1955-59 truck with auto trans. 1953-55 car with field installed switch ("4HD-B" stamped on plate)..... **\$30.00 ea.**
- 535371** Lever, Loma Gray with tan knob, 1953-55 car. Truck: various models 1949-64. See chassis manual to determine your application **\$30.00 ea.**
- 681729** Lever, chrome. Truck: 25 3E, 4E, various applications. Please see your chassis manual to determine application **\$26.00 ea.**
- 684548** Switch. Truck: E-2E with auto trans **\$26.00 ea.**

- 800478** Cancel. 1961-66 car all models except Avanti. Truck: 6E-8E 5, 7, 10, 12. Note: If your turn switch does not cancel after you turn, this is probably what is broken..... **\$11.00 ea.**
- 801095** Cancel. 1963-70 Avanti. If your turn switch does not cancel after you turn, this is probably what is broken **\$11.00 ea.**
- 1550921** Lever, chrome with black knob. 1956-60 car, all models..... **\$35.00 ea.**
- 1551930** Switch and cables. 1961-66 cars all except Avanti. Truck: Some 1961-62 and all 1963-64 without 4-speed. **\$75.00 ea.**
- 1552456** Lever, chrome handle with black knob. 1961 car, all models and 1966 Lark. Truck: 1961-64 Champ **\$35.00 ea.**
- 1555280** Lever, chrome with white knob, 1962-65 car, all models including Avanti **\$35.00 ea.**



- 1558203** Flasher. 1956-66 car, all models & 1963-85 Avanti. Truck: 5E-7E all **\$5.25 ea.**



BACK UP & NEUTRAL SAFETY SWITCHES

- AC-2973** Back-up, 1960 car with standard transmission **\$40.00 ea.**
- 522966** Back-up. 1947-50 car, all models..... **\$36.60 ea.**
- 527294** Neutral safety/backup. 1950 car, all models with automatic trans. **\$32.00 ea.**
- 530440** Neutral safety/backup light. 1951-52 car with auto trans **\$29.00 ea.**
- 534389** Backup light, standard transmission, only. 1955-59 car with Saginaw power steering except 1959 Hawks **\$48.00 ea.**
- 1540309** Neutral safety/backup light. 1956 Golden Hawk **\$63.50 ea.**
- 1549583** Back-up. 1960-61 Lark & Hawk with standard transmission..... **\$38.50 ea.**
- 1549665** Back-up & starter cut out. 1960 Lark. & 1960-61 Hawk with automatic transmission. **\$40.00 ea.**
- 1552780** Back-up & starter cut out. With automatic transmission, 1961-66 Lark & 1962-64 Hawk (on column) **\$36.50 ea.**

- 1557538** Back-up. 1963-64 Avanti with 3-speed transmission **\$88.00 ea.**
- 1557359** Back-up light. 1963-64, all models & 1963-85 Avanti with floor mounted automatic transmission **\$94.00 ea.**
- 1558650** Starter cut-out. 1963-64, all models & 1963-85 Avanti with floor mounted automatic transmission. **\$94.00 ea.**

BACK UP SWITCH BRACKET

- 1553199** Bracket. Back-up switch to 4-speed trans. 1961-64 Lark or Hawk & 1963-64 Avanti **\$19.95 ea.**

BRAKE LIGHT SWITCHES

- A**

B
- (A) 191078** 1942-50 car, all models with screw terminal. **\$37.90 ea.**
- 193032** Some 1938 cars, 1939-41 cars including Coupe Express, 1941-48 M-Series trucks **\$15.00 ea.**
- (B) 666858** All models with push type terminal. 1942-46 Champion & Commander. 1947-66 car & 1963-70 Avanti. Truck: 1942-64..... **\$14.50 ea.**

EMERGENCY BRAKE WARNING LIGHT & SWITCH

- 1360022** Warning light switch. 1964-66 Lark... **\$20.00 ea.**
- 1564499** Warning light. 1963-66 Lark. Mounts on dash. **\$25.00 ea.**

TRUNK & TAILGATE SWITCHES

- 801788** Avanti II trunk release switch..... **\$15.00 ea.**
-
- 1350475** Trunk light switch. 1963-85 Avanti. **\$35.00 ea.**
- 1352460** Rear window switch. 1963-66 station wagon with electric rear window on dash. **\$51.50 ea.**

HEADLIGHT SWITCHES

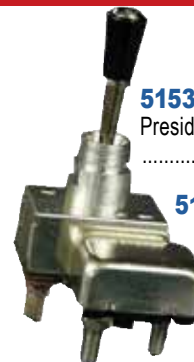

- 515324** 1942 Commander and President, 1942-46 Champion..... **\$75.00 ea.**
- 519798** 1947-49 car, all models..... **\$48.00 ea.**
- 526350** 1950 car, all models..... **\$74.40 ea.**
- 532134** 1953 car, all models... **\$38.40 ea.**

- 536217** 1955 C & K..... **\$95.00 Exch.**
- 536725** 1955 sedan with wrap around windshield **\$46.00 ea.**
- 680908** All 1941 cars. Truck: 2R, 3R, E, 2E, M-series..... **\$45.00 ea.**
- 1540063** 1956 sedan **\$52.00 ea.**
- 1540135** 1956 Hawk, black. Will also fit 1957 Hawk but knob is a different style **\$48.00 ea.**
- 1542263** 1957 car. Includes (1) 1544272 switch and instructions on how to convert it to 1957 specifications..... **\$40.00 ea.**
- 1544272** Black. 1958 sedan. 1958-62 Hawk.... **\$52.50 ea.**
- 1547332** 1959 Lark **\$28.00 ea.**
- 1549564** 1960 Lark **\$150.00 Exch.**
- 1551530** 1961-62 Lark. Truck: 1963-64. **\$125.00 Exch.**
- 1558720** White, 1963-64 Hawk..... **\$52.50 ea.**
- 1561930** White, 1963-83 Avanti. **\$.55.00 set/2**
- 1565148** White. 1964-65 Lark. Smooth and without ridges **\$90.00 ea.**
- 1565577** Black. 1966 Lark **\$48.00 ea.**

HEADLIGHT DIMMER SWITCHES

519246 1940-59 car, all models. Truck: M5-M15, 2R-4E, 5E-8E 13-16, 25-45.. **\$31.50 ea.**



1547356 1960-66 car, all models & 1963-74 Avanti. Truck: 5E-8E 5, 6, 7, 10, 11, 12..... **\$12.50 ea.**

FOG LIGHT SWITCHES

519145 Fog light switch, includes knob. 1947-48 Champion **\$34.00 ea.**

525475 Fog light switch, includes knob. 1949 Champion..... **\$26.50 ea.**

530143 Fog light. 1951-52 car, all models **\$75.00 ea.**

536292 1955 without curved windshield. (Includes C & K)..... **\$38.40 ea.**

HEATER SWITCHES

532133 1953-54 car, all models. Pictured..... **\$42.00 ea.**

534957 1954 Commander **\$35.00 ea.**

535229 1954 Champion **\$37.00 ea.**

536219 1955 All without wraparound windshield. Includes C & K **\$35.00 ea.**

536723 1955 All with wraparound windshield... **\$45.00 ea.**

1540283 1956 Hawk **\$32.00 ea.**

1542245 1957 sedan **\$37.00 ea.**

1547064 1956 sedan..... **\$37.00 ea.**

1547334 1959 Lark **\$27.00 ea.**

1547689 Heater control. 1959 Lark **\$25.00 ea.**

1549346 Heater control. 1960-62 Lark **\$25.00 ea.**

1549565 1960-61 Lark..... **\$35.00 ea.**

1550616 Auxiliary heater. 1960-62 Lark. **\$37.00 ea.**

1554978 1962 Hawk **\$36.00 ea.**

1555074 1962 Lark..... **\$41.00 ea.**

1558719 1963-64 Hawk **\$67.50 ea.**

1561930 1963-83 Avanti **\$48.00 set/2**

1565576 1966 Lark. **\$35.00 ea.**

1691701 For motor blower. Late 1959 & all 1960-64 C-cab trucks..... **\$35.00 ea.**

1692931 Truck: 1960-64 Champ.... **\$35.00 ea.**

HEAT SYNC

1565194 Heat sync. For Trans ignitor Ignition.. **\$96.00 ea.**

AIR CONDITIONER SWITCH

1552649 Switch, fan air control. 1961-62 Lark & Hawk..... **\$45.00 ea.**



Additional Air Conditioning parts are on pages 57 & 190

DEFROSTER SWITCHES

536219 1955 car without wraparound windshield including C & K..... **\$45.00 ea.**

536723 1955 with wrap around windshield..... **\$45.00 ea.**

1542247 1957 all models. **\$65.00 ea.**

1544278 Defroster. 1959-61 Hawk **\$38.00 ea.**

1554978 1962 Hawk. **\$36.00 ea.**

SWITCH LABEL SETS



801931 1956 Hawk, all models. Includes lights, instrument lights, defrost, air, wiper and heat **\$52.00 set/6**

801932 1957-62 Hawk, all models. Includes lights, instrument lights, defrost and air..... **\$36.00 set/4**

801933 1963-64 Hawk, all models. Includes lights, instrument lights, air and wiper. **\$36.00 set/4**

NOTE: Dash Labels are sold in kits only and are not available individually.

INSTRUMENT LIGHT SWITCHES

532132 1953 car, all models **\$36.00 ea.**

534956 1954 Commander **\$36.00 ea.**

535228 1954 Champion **\$32.00 ea.**

536218 1955 car **\$28.00 ea.**

1542265 1957 Hawk **\$55.00 ea.**

1544273 1958 sedan **\$30.00 ea.**

1559409 for rheostat. 1963-66 Lark. **\$25.00 ea.**

1561930 1963-83 Avanti **\$48.00 set/2**

1565576 1966 Lark **\$35.00 ea.**

1685892 1956 truck, all models. **\$28.00 ea.**

INTERIOR LAMP SWITCHES

281130X3 1947-52 Champion and Commander except convertible. Also used on some pre-war model sedans. Mounts on door pillar. Tan. **\$24.95 ea.**



285641 1942-46 Champion & 1947-66 all models. Truck: 1949-64 all, replacement. **\$12.00 ea.**

519157 Map light switch 1947-49 cars, 1953-55 C-K, 1949-64 C-Cab trucks **\$19.50 ea.**

801279 Same as 285641 but used original..... **\$25.00 ea.**

1351043 1963-87 Avanti Replacement. **\$13.00 ea.**

As always, if you don't see what you need, please call (317) 462-3124 & inquire

HORN BUTTON SWITCHES

1543008 Horn button contact switch. 1959-66 cars without horn ring & 1960-64 T-cab trucks..... **\$22.00 ea.**



ELECTRIC DOOR LOCK SWITCH

800503 Electric door lock switch. 1976-83 Avanti..... **\$15.00 ea.**

OIL PRESSURE LIGHT SWITCH

1539898 1956-62 car, all models with warning light. Truck: 3E-4E & 5E-6E 5, 6, 7, 10, 11, 12 & 7E-8E 5, 7, 10, 12 **\$9.00 ea.**



ANTI-CREEP SWITCHES

527260 Anti-creep solenoid valve control switch, on accelerator linkage. 1951-55 car **\$19.20 ea.**

527394 Solenoid valve pressure switch. 1950-64 car with automatic transmission.... **\$42.00 ea.**



527804 Solenoid. 1950-52 car..... **\$85.00 ea.**

532958 Solenoid. All 1953 and early 1954 Canadian built car. **\$85.00 ea.**

535546 Solenoid. All 1954 U.S. car and late 1954 Canadian built car. **\$85.00 ea.**

1548797 Anti-creep solenoid. 1959-66 car, all models..... **\$78.00 ea.**

MISCELLANEOUS SWITCHES

If you don't see the switch you need listed in our catalog, please call

(317) 462-3124

Additional Switches are available in limited quantities

WINDSHIELD WIPER

ELECTRIC SWITCHES

**Parking switch - located on motor and returns arms to down position when wipers are turned off*

307049 1951-55 car & truck: 1949-55 with Redmond motor..... **\$26.25 ea.**

307543 1953-55 car with American Bosch motor..... **\$65.00 ea.**

309018 1955 C-5 and K-5 body styles..... **\$28.00 ea.**

311087 1955 Autolite motors..... **\$28.00 ea.**

311467 1953-54 car, all models & 1955 sedan..... **\$44.25 ea.**

512814 1941 Commander & President..... **\$28.00 ea.**

1312459* Parking switch. 1956-62 car & truck with Autolite motor. **\$26.00 ea.

1312861 Control switch. 1956 Champion with vacuum type motor. **\$28.00 ea.**



1338055 1956-62 car, all models. American Bosch..... **\$42.00 ea.**

1351851* Parking switch. 1963-66 Lark..... **\$25.00 ea.

1558843 1963-64 Hawk..... **\$35.00 ea.**

1540134 1956 sedan..... **\$40.00 ea.**

1540137 1956 C & K..... **\$45.00 ea.**

1542261 1957 sedan & Hawk. Can be used through 1962 by changing the connectors..... **\$95.00 ea.**



1547333 1959 Lark..... **\$25.00 ea.**

1561520 Switch with grooves. 1963-64 Lark... **\$40.00 ea.**

1565152 Switch without grooves. 1965 Lark... **\$35.00 ea.**

1565578 1966 Lark..... **\$35.00 ea.**

1654663 Some 1957-59 truck..... **\$38.50 ea.**

WIPER SWITCH RETAINER NUTS (Chrome)

284969W 1947-55 car, all models, 1957-62 sedan & Lark. Truck: 1949-64 all..... **\$4.50 ea.**



536350W 1957-64 many models including Hawk. 9/16"..... **\$5.50 ea.**

WIPER SWITCH ESCUTCHEON

1557358 1963 - 1964 Avanti..... **\$20.00 ea.**

DRIVE ARMS, PIVOTS & RELATED PARTS

262609 Retainer & spring for wiper arms on 1936-39 car except Champion & all 1941-46 Champion cars with vacuum motors only. Truck: Early 2R... **\$10.00 ea.**

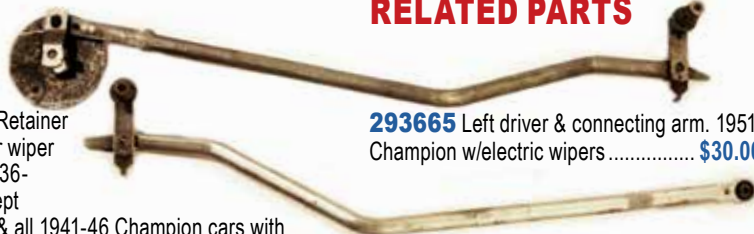

271842 Right wiper arm pivot. 1939 Commander & President with electric wipers..... **\$60.00 ea.**



271843 Left wiper arm pivot. 1939 Commander & President with electric wipers..... **\$60.00 ea.**

272534 Right or left wiper arm pivot. 1940 car, all except Champion. Takes 2..... **\$60.00 ea.**

274180 Right or left wiper arm pivot. 1941-42 car, all except Champion..... **\$60.00 ea.**

278428 Wiper arm, spring with rod. 1941-42 Champion with vacuum wiper..... **\$10.00 ea.**

284967W Wiper pivot spacer. 1947-52 car. Chrome..... **\$20.00 ea.**

1947-48 car. **285117** Right tensioner..... **\$18.00 ea.**

285118 Left tensioner..... **\$18.00 ea.**

286072 Right driver & cable. 1947-48 car..... **\$42.00 ea.**

286073 Left driver & cable. 1947-48 car..... **\$43.20 ea.**

287693W Wiper pivot nut. Chrome. 1947-66 car, all models & all Avanti. Truck: 1949-64, all. Takes 2. **\$4.95 ea.**

290158 Right driver & cable. 1949-50 car..... **\$35.00 ea.**

290159 Left driver & cable. 1949-50 car..... **\$39.00 ea.**

290160 Right tensioner. 1949-50 car..... **\$26.00 ea.**

290161 Left tensioner. 1949-50 car. **\$22.00 ea.**

293663 Clip, wiper arm to pivot. 1951-66 most models. Limited Supply..... **\$15.00 ea.**

293665 Left driver & connecting arm. 1951-52 Champion w/electric wipers..... **\$30.00 ea.**

293685 Left driver & connecting arm. 1951-52 Champion with vacuum wipers..... **\$36.00 ea.**

298231 Left driver & connecting arm. 1953-58 sedan & wagon with electric wipers.... **\$65.00 ea.**

298232 Right driver & connecting arm. 1953-58 sedan & wagon with vacuum or electric wipers **\$34.00 ea.**

298233 Left driver & connecting arm. 1953 sedan & wagon with vacuum wipers... **\$39.00 ea.**

298300 Wiper pivot gasket. 1947-66 car, all models except Avanti. Also used on 1960-64 truck. Takes 2..... **\$3.50 ea.**

298301W Wiper pivot chrome spacer. 1953-66 all models except Avanti. Truck: 1960-64 Champ. **\$18.00 ea.**

303840 Right driver & connecting arm. 1953-61 K-body coupe & hardtop with vacuum or electric wipers..... **\$57.00 ea.**

303841 Left driver & connecting arm. 1953-58 K-body coupe & hardtop with vacuum wipers..... **\$57.00 ea.**

303925 Left driver & connecting arm. 1953-64 C & K bodies with electric wipers..... **\$65.00 ea.**

652730 Wiper pivot spacer. 1949-64 C-cab truck. Chrome..... **\$32.00 ea.**

1332438 Right, driver & electric connecting arm. 1959-60 Lark..... **\$50.00 ea.**

1332475 Left, driver & electric connecting arm. 1959-60 Lark..... **\$50.00 ea.**

1339044 Right, driver & electric connecting arm. 1961-62 Lark..... **\$45.00 ea.**

1339045 Left, driver & electric connecting arm. 1961-62 Lark..... **\$51.50 ea.**

1343550 Right, driver connecting arm. 1962-64 GT Hawk..... **\$40.00 ea.**

1351380 Right, driver & arm. 1963-66 Lark..... **\$98.75 ea.**

1351023 Wiper pivot gasket Avanti. Truck: 1949-64 C-cab. Takes 2 **\$3.50 ea.**

1351024W Chrome washer, wiper pivot. 1963-91 Avanti. **\$8.00 ea.**

801698 Wiper pivot kit..... **\$48.50/kit**

1953-66 car all models excluding Avanti Truck: 1960-64 Champ.

Total of all parts if purchased separately..... **\$52.90**

801698..... **\$48.50/kit**

WIPER PIVOT KIT

1953-66 car all models excluding Avanti Truck: 1960-64 Champ.

Total of all parts if purchased separately..... **\$52.90**

801698..... **\$48.50/kit**



Kit Includes:

- (2) 287693W retainer nuts
- (2) 298300 leather washers
- (2) 298301W chrome spacers

WINDSHIELD WIPER RELATED PARTS

291188 Control cable for wiper motor. 1950 car **\$25.00 ea.**
293687 Control cable. Truck: 2R & all 1954-59 with vacuum wipers & 1951-52 Champion **\$26.00 ea.**

293749 Rubber gasket, wiper motor bracket to cowl. 1951-60 car with electric wiper motor & 1961-62 Hawk..... **\$4.50 ea.**

310844 Rubber gasket, windshield wiper motor to cowl. 1963-70 Avanti **\$2.00 ea.**



800345 Avanti Wiper motor cover, the factory may have left it off but here it is. Keeps dirt out and gives a more finished appearance under the hood. 1963-70 Avanti **\$15.50 ea.**



1339055 Rubber gasket, wiper motor bracket to cowl. 1961-62 Lark **\$2.50 ea.**

WINDSHIELD VACUUM WIPER MOTORS

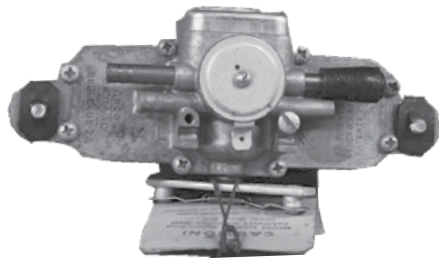

269939 Vacuum motor, new or good used one. 1939 Commander or President..... **\$120.00 ea.**

293684 Vacuum motor, new or good used one. 1951-52 car, all models **\$135.00 ea.**

298128 Vacuum. 1953-58 Champion..... **\$95.00 ea.**

303832 Vacuum. 1953-55 Champion C & K and 1959 Lark..... **\$110.00 ea.**

NOTE: We have limited quantities of Unlisted vacuum motors, please inquire!

POWER WINDOW AND/OR TAILGATE MOTORS



310075 Motor, 6-volt power window motor. 1955 car..... **\$195.75 ea.**

1351263 Motor. 1963-75 Avanti windows & 1963-66 station wagon tailgate with electric window..... **\$295.00 ea.**

ELECTRIC WIPER MOTORS

1. All wiper motors, whether rebuilt or new/old stock, are sold by exchange only.
2. Motors marked with * are available "new" as of this printing and are priced accordingly.
3. All rebuilt motors are dependent on core availability.
4. 1953-61 motors were made by American Bosch, Autolite, and Redmond. We cannot guarantee that the manufacturer of purchased motors will be the same as original.



NOS - ELECTRIC WIPER MOTORS

1351452 1963-64 Hawk. Truck: 1963-1964 Champ less mounting bracket..... **\$175.00 ea.** **1657096** Postal Zip Van **\$151.25 ea.**

REBUILT - ELECTRIC WIPER MOTORS

311168 1953-55 car **\$225.00 Ex.** **1339396** 1961-62 Hawk. Truck: 1961-1962 Champ **\$225.00 Ex.**
653277 1949-55 truck **\$225.00 Ex.** **1351040** 1963-1970 Avanti **\$395.00 Ex.**
1312320 1956-57 car **\$225.00 Ex.** **1351450** 1963-64 Lark **\$225.00 Ex.**
1323466* 1958-59 car. American Bosch 1959-60 **\$225.00 Ex.** **1654075** Truck: 1956 all & some 1957-58..... **\$225.00 Ex.**
1339330 1961-62 car. Truck: 1961-62 C-cab. (Autolite) **\$225.00 Ex.** **1654662*** 1957-60 Truck C-cab with ark-less terminals. **\$225.00 Ex.**
1339332 1961-62 car. American Bosch **\$225.00 Ex.** **1656319** Truck; 1963-64 C-cab.... **\$225.00 Ex.**

WIPER DRIVE ELECTRIC MOTOR REPAIR PARTS

295838 Brush & holder kit. 1951-55 car & truck: 1949-55 with "Redmond" motor .. **\$19.80 ea.**



307043 Spring for brush. 1951-55 car with "Redmond" wiper motor & truck: 1949-55. **\$3.00 ea.**

307542 Armature. 1953-55 with American Bosch..... **\$75.00 ea.**

311079 Spring for brushes. 1955 Autolite motors. Takes 2..... **\$2.50 ea.**

311084 Armature. 1955 car & truck with Autolite motor..... **\$70.00 ea.**

311085 Commutator head for Autolite motor. 1955 car & truck. Includes brushes **\$45.00 ea.**



311089 Motor gear. 1955-62 car & truck with Autolite motor..... **\$18.00 ea.**

1312210 Armature. 1956-62 Autolite..... **\$80.00 ea.**

1314983 Armature. American Bosch. 1956-62 car, 1960-61 Truck..... **\$80.00 ea.**

1351857 Motor drive gear. 1963-66 car **\$16.00 ea.**

POWER WINDOW RELATED PARTS



131026 Rubber grommet on door, wires pass through. 1963-64 Avanti, before #5168..... **\$4.00 ea.**

308456W Chrome housing for power window switches on 1955-58 4-door car. 4-button **\$35.00 ea.**

310216 Relay, to ignition switch. 1955 car **\$52.00 ea.**

310425X1 Switch with chrome knob. 1-button. 1955-58 car **\$45.00 ea.**

310425X2 Switch with gold knob. 1-button. 1955-58 car **\$45.00 ea.**

311008 Circuit breaker, window lift. 1955 with power windows **\$22.50 ea.**

311347 Drive end head for power window motor. 1955 car..... **\$35.00 ea.**

311351 Commutator end head for 6-volt window motor. 1955 car. Includes brushes. **\$50.00 ea.**

311352 Armature for window motor. 1955 car... **\$70.00 ea.**

802444 Avanti power window switch bezel..... **\$30.99 ea.**

1312959 Armature for window motor. 1956-58, 12-volt. **\$60.00 ea.**

1355430 Motor sacrifice gear, brass. 1963-75 Avanti..... **\$52.50 ea.**

Windshield wiper arms & blades on page 54
 Window glass, frames, regulators & hardware pages 48-52

NOTE: All harnesses are made with plastic coated wire & are color coded as original. Unless the harness is NOS, they are made to order and require 2-6 weeks for shipping. Please inquire about anticipated delivery time frame when ordering harnesses marked with an asterisk before the part number. These harnesses have special foreseen circumstances that will require more than 6 weeks.

CHASSIS FRONT WIRING HARNESSSES

Dashboard & Forward

181844-5 1934 Commander. Dash & engine	\$215.00 ea.
196741 1939 Champion	\$135.00 ea.
513160 1940 Champion	\$170.00 ea.
519823 1947-49 Champion	\$240.00 ea.
520350 1947-49 Commander	\$235.00 ea.
526361 1950 Commander	\$260.00 ea.
526362 1950 Champion	\$260.00 ea.
530297 1951 Champion	\$220.00 ea.
530298 1951 Commander	\$220.00 ea.
531670 1952 Champion	\$240.00 ea.
531671 1952 Commander	\$240.00 ea.
534383 1953-54 Champion & C & K body car after serial # 1, 235, 258	\$300.00 ea.
535404 1953-54 Commander C & K	\$335.00 ea.
536539 1955 Champion C & K	\$175.00 ea.
536540 1955 Commander & President V-8 sedan without wraparound windshield	\$305.00 ea.
536541 1955 Commander & President C & K	\$300.00 ea.
537085 1955 Champion sedan with wraparound windshield	\$300.00 ea.
537086 1955 Commander & President sedan w/ wraparound windshield	\$330.00 ea.
537423 1955 Speedster	\$400.00 ea.
675149 Truck: M5, 15, 15A, M16	\$280.00 ea.
682891 Truck: 1949-53 2R, 1954 3R, 1955 E 6-cylinder	\$245.00 ea.
684030 Truck: 1955 E V-8	\$257.00 ea.
1540233 1956 Commander & President	\$305.00 ea.
1540234 1956 Champion. NOS	\$200.00 ea.
1540235 1956 Hawk V-8	\$305.00 ea.
1540839 1956 Golden Hawk	\$425.00 ea.
1542270 1957 Hawk 6-cylinder	\$325.00 ea.
1542271 1957 Hawk V-8	\$440.00 ea.
1542282 1957 Champion 6-cylinder. NOS	\$250.00 ea.
1542283 1957 Commander & President	\$385.00 ea.
1545041 1958 Hawk V-8	\$415.00 ea.
1545043 1958 Champion. NOS	\$250.00 ea.
1545197 1958 Commander & President	\$300.00 ea.
1547442 1959 Lark 6-cylinder	\$87.00 ea.
1548411 1959 Hawk 6-cylinder or V-8	\$225.00 ea.
1549100 1959 Lark front chassis 6-cylinder & V-8. NOS	\$85.00 ea.
1549443 1960 Lark 6-cylinder. NOS	\$420.00 ea.

WIRING HARNESSSES

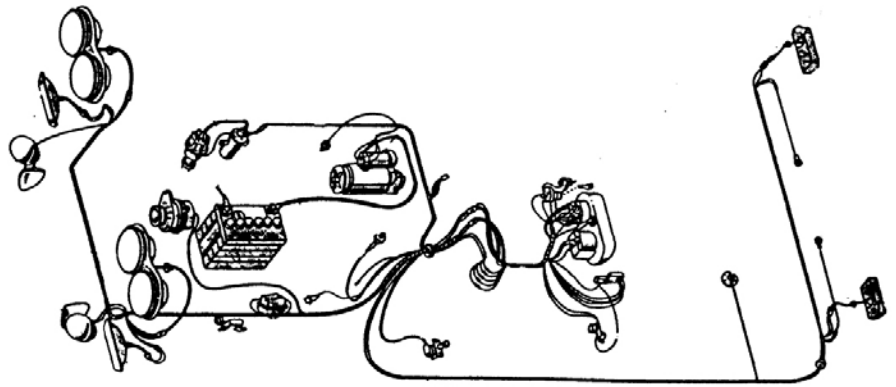

CHASSIS FRONT WIRING HARNESSSES

Dashboard & Forward (Continued)

*1549444 1960 Lark V-8	\$395.00 ea.
*1550079 1960 Hawk	\$320.00 ea.
1550080 1960 Hawk 6-cyl.	\$300.00 ea.
1552125 1961 Lark 6-cyl. NOS	\$250.00 ea.
*1552721 1961 Hawk V-8	\$420.00 ea.
*1554878 1962 Lark V-8	\$390.00 ea.
1554880 1962 Lark 6-cylinder. NOS	\$250.00 ea.
*1554950 1962 Hawk V-8	\$395.00 ea.
1557426 1963-64 Avanti	\$2,051.00 ea.
1558777 1963 Hawk 6-cyl.	\$275.00 ea.
1558995 1963 Lark 6-cylinder. NOS	\$275.00 ea.
1560091 1963-64 Hawk V-8	\$420.00 ea.
1561445 1964 Lark V-8. NOS	\$290.00 ea.
1561446 1964 Lark 6-cylinder. NOS	\$275.00 ea.
1563476 1965-66 Lark V-8. NOS	\$290.00 ea.
1563506 1965-66 Lark 6-cylinder. NOS	\$275.00 ea.
1685379 Truck: 2E V-8	\$235.00 ea.
1689567 Truck: 3E & 4E 6-cylinder	\$200.00 ea.
1689569 Truck: 3E & 4E V-8	\$230.00 ea.
1693350 Truck: 6E 5	\$310.00 ea.
1694264 Truck: 7E-8E 15, 25, 35, 45	\$320.00 ea.
1696306 Truck: 8E 5, 10. NOS	\$280.00 ea.
1696307 Truck: 1963-64 8E 7, 12. NOS	\$280.00 ea.
1696572 Truck: 8E diesel	\$290.00 ea.

WIRING HARNESS CLIP

536795 Clip, wiring to cowl brace, most models



\$4.50 ea.

WIRING DIAGRAMS

800976R Copied from original shop manuals. These diagrams include color codes. Please specify year, model & engine when ordering

\$3.50 ea.

CHASSIS REAR WIRING HARNESSSES

519817 1947-48 all except Land Cruiser	\$85.00 ea.
520810 1947-49 Land Cruiser	\$90.00 ea.
526364 1950 Land Cruiser	\$90.00 ea.
526366 1950 Champion & Commander with turn signals	\$90.00 ea.
530177 1951-52 all except Land Cruiser	\$85.00 ea.
530178 1951-52 Land Cruiser	\$85.00 ea.
534367 1953-54 C & K	\$97.00 ea.
536542 1955 sedan	\$90.00 ea.
536543 1955 C & K	\$90.00 ea.
665624 Truck: M-5	\$100.00 ea.
680000X1 Truck: 2R 5, 6 without turn signals	\$85.00 ea.
683136X1 Truck: 2R 3R, E 5, 6 with turn signals	\$95.00 ea.
683136X2 Truck: 2R 10, 11, 14, 15 with turn signal	\$97.50 ea.
1540181 1956-59 C & K & 1956-58 sedan	\$105.00 ea.
1548277 1959 Lark	\$85.00 ea.
1549445 1960-61 Lark	\$85.00 ea.
1549446 1960-61 station wagon	\$85.00 ea.
1550081 1960-64 C & K. NOS	\$120.00 ea.
1554678 1962-63 Lark. NOS	\$90.00 ea.
1559299 1963 Lark station wagon with manual tailgate. NOS	\$100.00 ea.
1561543 1964-66 Lark station wagon with manual tailgate. NOS	\$95.00 ea.
1561544 1964-66 Lark. NOS	\$90.00 ea.
1565053 1964-66 Lark station wagon with electric tailgate. NOS	\$120.00 ea.
1692317 Truck: 5E-6E 13, 14, 16, 28, 40. NOS	\$80.00 ea.
1692318 Truck: 5E-6E 16, 28, 40. 7E 5, 7, 10, 12 with narrow box. NOS	\$80.00 ea.
1692335 Truck: 5E-6E 5, 6, 7, 10, 11, 12 with narrow box. NOS	\$85.00 ea.
1693847 Truck: 7E 5, 7, 10, 12 with wide box. NOS	\$95.00 ea.
1694266 Truck: 7E - 8E 15,25, 35, 45, 131", 143", 155" with wide box. NOS	\$90.00 ea.
1694267 Truck: 7E - 8E 15,25, 35, 45, 195" with wide box. NOS	\$90.00 ea.

OVERDRIVE WIRING HARNESSES

- 196937** 1939-40 Champion \$38.00 ea.
 - 519822** 1947- early 1950 Champion. 1947-50 Commander..... \$65.00 ea.
 - 527426** Late 1950-52 Champion. Late 1950 Commander..... \$60.00 ea.
 - 530355** 1951 Commander \$55.00 ea.
 - 531727** 1952 Commander..... \$72.00 ea.
 - 532636** 1953-54 Champion C & K. 1955 Champion with lockout switch. \$58.00 ea.
 - 534004** 1953-55 Champion sedan. NOS..... \$82.00 ea.
 - 534399** 1953-54 Commander C & K. 1955 Commander with lockout switch. \$64.00 ea.
 - 537410** 1955 Champion sedan without lockout switch..... \$58.00 ea.
 - 679754** Truck: 1949-53 2R, 1954 3-R, 1955 E.. \$60.00 ea.
 - 684836** Truck: 1955 E without lockout switch \$60.00 ea.
 - 1540182** 1956 Golden Hawk before 6.031.808. NOS..... \$65.00 ea.
 - 1540299** 1956-57 Champion. NOS. \$58.00 ea.
 - 1540300** 1956-57 C & K 6-cyl..... \$35.00 ea.
 - 1540305** 1956-57 C & K V-8..... \$58.00 ea.
 - 1540310** 1956-57 sedan V-8..... \$58.00 ea.
 - 1548251** 1959-60 all models. NOS. \$26.00 ea.
 - 1552343** 1961-63 all models. NOS. \$26.00 ea.
 - 1562249** 1964 all models. NOS \$38.00 ea.
 - 1685847** Truck: 1956-59 2E-4E with relay. \$65.00 ea.
- ### MISC. WIRING HARNESSES
- 288694** 1947-50 convertible top motor. \$100.00 ea.
 - 288955** 1947-50 convertible. Switch to breaker. \$18.00 ea.
 - 288956** 1947-50 convertible. Breaker to solenoid..... \$20.00 ea.
 - 529211** 1950 Champion & Commander. Front turn signals \$50.00 ea.
 - 529341** 1950-51 Champion. Anti-creep \$55.00 ea.
 - 530524** 1951 Commander. Anti-creep..... \$55.00 ea.
 - 530575** 1951 Champion & Commander. Front turn signals \$39.00 ea.
 - 531783** 1952 Champion & Commander. Front turn signals. \$39.00 ea.
 - 532982** 1953-55 V-8. Generator to regulator..... \$18.00 ea.
 - 533095** 1953-54 sedan. Anti-creep..... \$56.00 ea.
 - 533230** 1953-54 all models. Front turn signals.. \$38.00 ea.
 - 536150** 1955 all models. Front turn signals. \$59.00 ea.
 - 536545** 1955 sedan. Anti-creep. \$58.00 ea.
 - 536546** 1955 C & K. Anti-creep..... \$58.00 ea.
 - 1540837** 1956 Golden Hawk. Starter switch to junction \$18.00 ea.
 - 1552256** harness, air conditioning, ignition switch to a/c switch, 1961 Lark \$15.00 ea.

BATTERY BRACKETS & SUPPORTS

- 285758** 6-volt. 1947-55 car, all models. Truck: 1949-55..... \$45.80 ea.
- 
- 770031** 1963 Avanti..... \$34.00 set/2
- 
- 800024** 10 7/8 inch long "J" bolt retainer with washer & wing nut..... \$4.50 ea.
- 
- 1312971P** 12 volt. 1956-58 car, all models. 1959-64 Hawk. Truck: 1956-64 C-cab. \$34.00 ea.
- 
- 1312973P** bracket, battery to fender. 1956-64 C & K body..... \$15.50 ea.
- 
- 1314745** 9 3/4 inch long "J" bolt retainer with washer & wing nut. 1956-64 C & K body, except 1958 Packard Hawk. Takes 2..... \$24.10 ea.
- 
- 1323655** 12 volt. 1956-58 car, all models. 1959-64 Hawk. Truck: 1956-64 C-cab \$24.00 ea.
- 
- 1339477** 12 volt. 1959-66 Lark. 1964-85 Avanti. Truck: 1960-64 Champ \$22.00 ea.
- 
- 1350251X1** Reinforcement for battery hold down bolt & bracket (1350251)..... \$15.00 ea.
- 

BATTERY TRAY

Reinforcement
1965-85 Avanti
800076 Metal panel fits under battery. Bracket bolts to radiator support & front sway bar bolt. Standard on later models. Good addition on earlier models..... \$59.95 ea.



BATTERY BOX Reinforcement

800077 A factory addition on some 1963 Avanti. This fiberglass reinforcement fits under the fender well, adding strength to hold battery \$45.00 ea.



BATTERY MAT

This battery mat offers every car around-the-clock protection from an ever-present threat: its own battery. A battery can leak undetected for months, causing rust on any metal surface the acid encounters. This rust, of course, can cause irreversible damage to body parts resulting in costly repairs or even accidents.

The battery mat (which is slightly larger than a standard size battery) is inserted underneath the battery, which is then clamped down as usual. It can be installed easily at any time, either under an existing battery or when replacing an old one.

Once installed, this battery mat will trap and neutralize battery acid that leaks from the terminals or top side of the battery, thus preventing corrosion and expensive damage. Because of the latex sealant, this battery mat can repel water and keep the acid neutralizers sealed in and potent. Because the latex sealant is not impervious to battery acid, however, the acid will seep into the battery mat's highly porous fabric, where it will be absorbed and harmlessly neutralized.

Everyone who owns a car should install one to prevent damage from a leaking battery. It is usable in Brand "X" cars as well as Studebakers, in recreational vehicles such as motor homes and motor boats.

800804 \$7.00 ea.

JUNCTION BLOCKS

Headlight Cables

198061
Three terminals.
1940-51 car,
most models &
1956 Golden Hawk. Various applications. Truck:
1941-48 M-series, 1949-59 C-cab..... \$42.00 ea.



519186 Five terminals. 1947-57 car, most models..... \$42.00 ea.



HORN

196673 Cup, push button spring contact. 1940-42 Commander, 1947-50 Champion & Commander.....**\$6.00 ea.**

192245 cap, push button contact. Various models of cars & trucks.....**\$29.95 ea.**

192247 Horn plate, various models of cars & trucks.....**\$35.00 ea.**

519180 Spacer, horn. 1947-56 car & 1957 Champion. Also substitutes for various early cars and trucks. Takes 3.....**\$3.60 ea.**

520411 Horn ring push back, sponge. 1947-56 car, all models with horn bar or ring.....**\$22.00 ea.**

522198P Horn bar. Painted. 1947-48 Commander.....**\$50.00 ea.**



522198W Horn bar. Chrome. Pictured above. 1947-48 Commander ...**\$75.00 ea.**

533467
Cable. 1953-56 sedan, all models with power steering.....**\$16.50 ea.**

533468 Cable. 1953-56 C & K with Saginaw power steering.....**\$25.00 ea.**

1539065 Horn cable, 1938-56 all car plus 1957 Champion 6-cylinder with 3-spoke wheel and without power steering. Truck: 1941-48 M-series and 1949-64 C-cab.....**\$15.00 ea.**

1541949 Switch. 1957-66 car with type A & B steering wheels. See Chassis Parts Manual**\$20.00 ea.**

1541950 Spacer. 1957-60 and 1963-66, all with horn ring. 1957-66 all with horn button.....**\$7.25 ea.**

1541961W Center ring, chrome. 1957-66 car, all models without horn ring.....**\$18.00 ea.**

1541991 Contact plate. 1957-66 car, all models.....**\$18.00 ea.**



1542007 Horn cable with brushes, 1957-59 Hawk with Saginaw power steering**\$18.00 ea.**

1542795 Cable extension. 1962-64 Hawk with power or disc brakes.....**\$4.00 ea.**

1543008 Switch. 1957-66 car with center button & 1960-64 T-cab trucks.....**\$25.00 ea.**

1551595 Spacer for horn bar. 1961-62. Substitutes for many cars & trucks back through the 1940's..**\$4.50 ea.**



1552237 Roller & bracket assembly. 1961 Lark.....**\$25.00 ea.**

1555303 Roller & bracket Assembly. 1962-66 car, all models except Avanti.....**\$28.00 ea.**

Please see page 33 for horn buttons.

Can't find the part you're looking for?

Call & we'll be glad to look for a part just for you!



(317) 462-3124

We welcome overseas customers

HORNS - Replacement

800927 Sold in pairs only — 1 high and 1 low tone. Comes with universal type mounting bracket for all model cars and trucks. 12-volt**\$169.55 pr.**



1544080 Horn, Autolite Hi. 1957-58 car. NOS.....**\$95.00 ea.**
1562522 Horn, Delco Lo. 1964-66 car. NOS.....**\$95.00 ea.**

HORN RELAYS

190085 1937 Dictator & Coupe Express. 1947-55 car, all models. Truck: M5-M17 & 2R-E.....**\$41.90 ea.**

1539596 1956-58 car, all models. Truck: 2E-4E.....**\$27.00 ea.**

1547377 Pictured 1959-62 car, all models. Truck: 5E-8E.....**\$54.00 ea.**

1557365 1963-66 car, all models & 1963-85 Avanti. Truck: 8E.....**\$43.30 ea.**





Wayne Dawson's 1958 Packard Hawk from Payson, Arizona

TRANSMISSION SECTION GLOSSARY

Transmission Assemblies	216
Frame Cross Members	216
Floor Shifter Assemblies & Related Parts ..	217-218
Seals & Gaskets	219
Clutch Related Parts	220-224
Overdrive Related Parts	226-228
T86 & T96 Related Parts	230-235
DG Automatic Related Parts	236-241
Flight-O-Matic Related Parts	242-245



TRANSMISSION ASSEMBLIES



- 681756** T-97 4-speed transmission. 2R 16 & 17 model truck. Only one in stock..... **\$900.00 ea.**
- 1545946** Standard transmission. 1958 6-cylinder taxi..... **\$550.00 ea.**
- 1546523** T90 standard transmission. 1959-60 taxi or 6-cylinder car with 10.5" clutch..... **\$550.00 ea.**
- 1548177** T-90 standard transmission. 1959-60 taxi or 6-cylinder car without 10.5" clutch..... **\$550.00 ea.**
- 1551596** T-90 standard transmission. 1961-64 6-cylinder taxi..... **\$550.00 ea.**

- 1555803** Standard transmission. 1962 6-cylinder taxi with floor shift..... **\$550.00 ea.**
- 1563833** Automatic transmission. 1965 & early 1966 6-cylinder car with 194 cubic inch engine..... **\$650.00 ea.**
- 1564207** Automatic transmission. 1966 car with 230 cubic inch 6-cylinder engine..... **\$650.00 ea.**
- 1565176** Standard transmission, T-90 floor shift. 1965-66 6-cylinder 194 cubic inch taxi..... **\$550.00 ea.**
- 1565206** Automatic transmission. 1966 6-cylinder car after serial # C-130329. Standard duty..... **\$650.00 ea.**

1687347 3-speed manual transmission E-7 -8E truck models 7 & 12 all with 4.27, 4.55, 4.56, and 4.88 rear axle. Only one in stock..... **\$795.00 ea.**

1687687 3-speed manual transmission E-7 -8E truck models 7 & 12 all with 3:73, 4:09, and 4:10 rear axle. Only one in stock..... **\$750.00 ea.**

1688944 3-speed manual transmission, 3E & 4E truck models 2, 7, & 12 (V-8) with 4.27, 4.55, and 4.88 rear axle..... **\$750.00 ea.**

1692287 3-speed manual transmission 5E 6 and 11 truck models with 3:73, 4:09, and 4:10 rear axle..... **\$750.00 ea.**

1692797 3-speed manual transmission, models 8E 5 & 10 (RHC)..... **\$750.00 ea.**

FRAME CROSS MEMBERS - Cars

- 518499** Front frame cross member. 1947-49 Champion..... **\$150.00 ea.**
- 1539366** Rear engine support cross member. 1956 Golden Hawk. (1501-8)..... **\$320.00 ea.**
- 1541389** Rear shock absorber cross member. 1955-66 cars..... **\$95.00 ea.**
- 1545042** Front frame cross member. 1958-64 car..... **\$325.00 ea.**



- 1546103** Rear engine support cross member. 1958 6-cylinder taxi with standard transmission. May fit other vehicles..... **\$85.00 ea.**
- 1547507** Gas tank support member. 1955-66 cars..... **\$95.00 ea.**
- 1550389** Rear engine support cross member. All convertibles 1960-64 except late 1963-64 6-cylinder..... **\$140.00 ea.**

- 1555884** Rear frame, tubular stainless steel. 1963-85 Avanti. Includes center mounting bracket. Pictured..... **\$145.00 ea.**
- 1563626** Frame front cross member. 1965-66 car..... **\$325.00 ea.**
- 1563727** Rear engine support cross member. All 1965-66 cars except sliding roof wagon..... **\$115.00 ea.**

FRAME CROSS MEMBERS - Trucks

- 673015** Front frame cross member. 2R through 6E 13 & larger. Also 7E & 8E model 13, 28, 40..... **\$100.00 ea.**
- 673976** Third cross member. 2R through 6E model truck 13 & larger. Also 7E & 8E models 13, 28, & 40..... **\$120.00 ea.**
- 674037** Fifth & sixth frame cross member. Most larger 1949-64 truck. Call for exact application (317) 462-3124. Only one in stock..... **\$95.00 ea.**
- 678164** Right frame member & engine support. All 1949-64 truck except 1/2 & 3/4-ton **\$75.00 ea.**
- 678165** Left frame member & engine support. All 1949-64 truck except 1/2 & 3/4-ton **\$75.00 ea.**
- 679290** Spare tire support. Late 2R through 8E truck models 16 through 45 with 9.00x20 or 10.00 X22.5 tires..... **\$120.00 ea.**
- 680942** Spare tire support. Late 2R and all 3R through 8E 1/2 & 3/4-ton..... **\$65.00 ea.**
- 682818** Spare tire support. 2R through 8E models 13, 14, & 15..... **\$120.00 ea.**

- 1690462** Second frame cross member. All 1957-64 truck models..... **\$130.00 ea.**
- 1692475** Left frame member & engine support. 1960-62 T-cab 1/2 & 3/4-ton truck. Only one in stock..... **\$130.00 ea.**
- 1693031** Front cross member. 1960-64 T-cab, both 1/2 & 3/4-ton. Only one in stock..... **\$160.00 ea.**
- 1696822** Right frame member and engine support. 1963-64 T-cab truck 1/2 & 3/4-ton. Only one in stock..... **\$130.00 ea.**

MOUNTING BRACKETS

Automatic transmission rear support - Trucks

- 683979** Truck: E & 2E 7, 12, with DG automatic transmission..... **\$99.95 ea.**
- 1686126** Truck: E - 2E, 7 12, with Flight-O-Matic automatic trans. Also 3E-4E 2, 7, 12, 14 with automatic transmission..... **\$99.95 ea.**
- 1692223** Truck: 5E & 8E 2, 7, 12, 13 with automatic transmission..... **\$99.95 ea.**

FRAME RAIL PLATES



- 800079** Closes lower rail of frame on front section. Left or right. 1953-66 car and 1963-85 Avanti..... **\$90.00 ea.**
- 800080** Closes lower rail frame on rear section. Left or right. 1953-66 2 door sedan, convertible, and hardtop, all except C & K. Will also fit 1963-85 Avanti..... **\$120.00 ea.**

AVANTI REAR FRAME SADDLE (Body Mount)

Rear cross member welds to it.

- 800917** Left..... **\$82.50 ea.**
- 800918** Right..... **\$82.50 ea.**



TORQUE CONVERTERS

- 527825** 1950-56 Champion with DG type 3-band transmission **\$550.00 ea.**
1556424 Late 1963- 1964 6-cylinder. **\$265.00 ea.**

- 1563826** 1965-66 6-cylinder **\$265.00 ea.**
1563827 1965-66 283 V-8 **\$265.00 ea.**

SHIFTER LEVER GROMMET



- 532551** At end of lever where it attaches within steering column. 1953-66 car, all models with column shifter, standard or automatic transmission..... **\$8.00 ea.**

FLOOR SHIFTER ASSEMBLY PARTS

Lark, Hawk, Avanti, all with Automatic Power Shifting

- (1) **1556344** Cap. 1963-64 Lark & Hawk. 1963-83 Avanti..... **\$4.00 ea.**
 (2) **1556346** Chrome shifter ball. 1963-64 Lark & Hawk. 1963-83 Avanti..... **\$12.00 ea.**
 (3) **1556342** Spring. 1963-64 Lark & Hawk. 1963-85 Avanti **\$3.00 ea.**
 (4) **1556383** Shaft. 1963-64 Lark & Hawk. 1963-85 Avanti **\$8.00 ea.**
 (5) **1556343** Spring. 1963-64 Lark & Hawk. 1963-85 Avanti **\$3.00 ea.**
 (6) **1556333** Chrome lever. 1963-64 Lark & Hawk. 1963-85 Avanti. **\$28.00 ea.**
 (8) **1556328** Shifter dial. 1963-83 Avanti, 1963-64 Hawk, 1963-66 Lark with floor mounted power shift automatic. **\$39.50 ea.**
 (9) **1556347** Dial screw. 1963-64 Lark & Hawk. 1963-85 Avanti. **15¢ ea.**
 (10) **1556338** Chrome housing. 1963-64 Lark & Hawk. 1963-74 Avanti. **\$65.00 ea.**
 (11) **287533** Rubber bumper. 1963-64 Lark & Hawk. 1963-85 Avanti. **\$3.00 ea.**
 (13) **1558210** Bracket. 1963-64 Lark & Hawk. 1963-85 Avanti. **\$16.00 ea.**
 (14) **1539489** Insulator grommet. 1963-64 Lark & Hawk. 1963-85 Avanti **\$8.00 ea.**
 (15) **1541533** Rod swivel. 1963-64 Lark & Hawk. 1963-85 Avanti **\$18.95 ea.**
 (17) **1556350** Rubber boot. 1963-64 Lark & Hawk. 1963-85 Avanti **\$26.00 ea.**
 (18) **1556351** Retainer. 1963-64 Lark & Hawk. 1963-85 Avanti. **\$5.50 ea.**

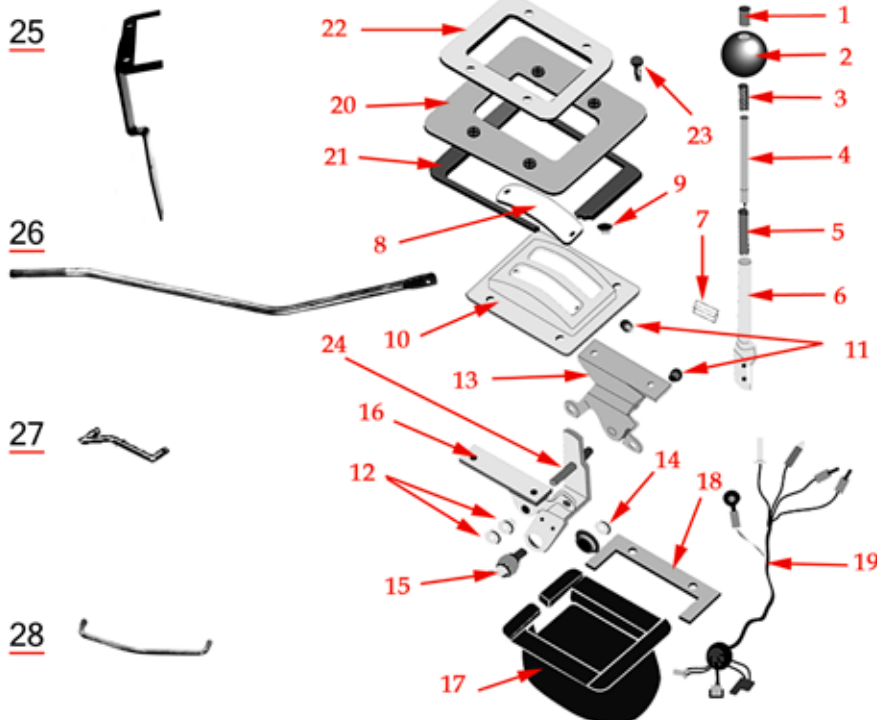

- (25) **1560311** Wiring harness. 1963-64 Lark & Hawk **\$45.00 ea.**
 (20) **1560348** Retainer plate. 1963-64 Lark & Hawk **\$16.00 ea.**
 (21) **1557275** Assembly to console seal. 1963-85 Avanti **\$6.50 ea.**
 (23) **G114988** Rivet, upper to lower level. 1963-64 Lark & Hawk & 1963-85 Avanti.... **\$1.25 ea.**
 (24) **1556334** Lever assembly. 1963-85 Avanti. **\$16.00 ea.**
 (24) **1560332** Lever assembly. 1963-66 Lark & Hawk **\$40.00 ea.**
 (25) **1557447** Bracket. 1963-85 Avanti..... **\$12.00 ea.**
 (25) **1560340** Bracket, starter cut-out & backup switch. 1963-66 Lark & Avanti..... **\$20.00 ea.**
 (26) **1557319** Rod. 1963-74 Avanti.. **\$12.50 ea.**
 (26) **1558806** Rod. 1963-64 Lark... **\$12.50 ea.**
 (28) **1557390** Rod, starter cut-out switch. 1963-64 Lark & Hawk. 1963-85 Avanti **\$4.50 ea.**

SHIFTER KNOBS



- (B) **515645X1** 1942 Commander & President. 1946 Champion. 1947-49 car, all models with column shift. White..... **\$20.45 ea.**
 (C) **515645X2** 1949-60 truck, all models with column shift. Black..... **\$20.45 ea.**
 (D) **515645X4** 1950-52 car, all models with std. trans. & column shift. Light tan color **\$20.45 ea.**
 (A) **524623** 1950-52 car with automatic transmission column shift. Tan..... **\$15.00 ea.**
 (E) **533343X1** 1953-57 car, all models with column shift. Dark gray. **\$25.00 ea.**
 (F) **533343X2** 1955 car, all models with column shift. Pearl metallic..... **\$25.00 ea.**
 (G) **533343X3** 1956-57 car, all models with column shift. Black..... **\$25.00 ea.**

- (H) **1543412X1** 1958-61 car, all models & 1966 all models. Black. NOS **\$18.00 ea.**
 (I) **1543412X2** 1962-65 car, all models with column shift. Off-white **\$18.00 ea.**
 (J) **1552824** 1961-64 Lark or Hawk & 1963-64 Avanti with original type 4-speed floor shifter transmission..... **\$27.50 ea.**
1555731 Ball, 3-speed floor shift. 1963-64 Avanti with 3-speed manual transmission..... **\$15.00 ea.**
 (K) **1686060** Truck, all models with floor mounted shift. Black..... **\$22.85 ea.**

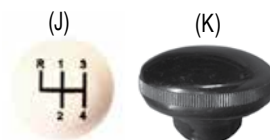

SHIFTER BOOTS

1339521 1961-64 Lark and Hawks with 4-speed. Improved design keeps boot in place beneath retainer..... **\$46.55 ea.**



1556146 1963-64 Avanti 3 or 4-speed shifter boot. Made of high quality neoprene to last and keep hot air out. Enlarged lip on 1963-style boot enables it to fit on 1964 Avanti..... **\$42.50 ea.**

SHIFTER COVERS



1339710 1961-64 Hawk with 4-speed transmission floor board lever. **\$95.00 ea.**

1343800 1962-64 Lark with 4-speed transmission..... **\$95.00 ea.**



1347779 Fiberglass shifter plate with 4-speed transmission. 1964-85 Avanti **\$25.00 ea.**



1347877 Fiberglass shifter plate with auto transmission. 1963-85 Avanti **\$25.00 ea.**

SHIFTER REBUILD KIT



802390 1961-64 all with 4-speed floor shift including Avanti. Includes pin, bushing (2), in retainer clip (2), space washer (2), spring washer, and anti-rattle plate..... **\$45.00 kit**

SEALS

STANDARD TRANSMISSION GASKET SETS

- S-628** 1939-40 Champion **\$18.00 ea.**
- S-629** 1941-46 Champion **\$18.00 ea.**
- S-630** 1936-37 President **\$18.00 ea.**
- S-632** 1940 Commander & President..... **\$18.00 ea.**
- S-641** Truck: M-series with 4-speed trans. & 1949-56 trucks with T-9 or T9A 4-speed transmission..... **\$18.00 ea.**
- S-642** Truck: 1941-48 M5 without overdrive & with overdrive before serial # M5-33, 948 **\$18.00 ea.**
- S-682** Truck: 1949-64 16-17 & 28 with T-97 4-speed..... **\$18.00 ea.**

- 535516** 1941-57 Champion with T-96 & overdrive..... **\$21.60 ea.**
- 800380** 1951-57 V-8 car with T-86 and overdrive. Truck:1941-57 6-cylinder with T-86 and overdrive. Includes 10 gaskets..... **\$27.50 ea.**
- 1546281** 1958-64 6-cyl, with T-96. Includes 5 gaskets **\$18.00 ea.**
- 1546282** 1958-64 car with T-86 3-speed transmission **\$25.00 ea.**
- 1546283** 1956-58 car with T-85 3-speed transmission **\$18.00 ea.**
- 1561840** 1961-64 car & 1963-64 Avanti with T-10 4-speed. Includes 8 gaskets **\$29.00 ea.**

AUTOMATIC TRANSMISSION REAR SEALS

- 1541097** 1950-55 car, all models. 1956-57 Speedo gear housing. Truck:2E 7, 12 & 3E-6E 2, 7, 12 & 7E-8E 5, 7, 10, 12. **\$13.00 ea.**
- 1553737** 1958-66 V-8, 1958- early 1963 6-cylinder and 1963-71 Avanti..... **\$10.00 ea.**

AUTOMATIC TRANSMISSION FRONT SEALS

- 529582** 1950-55 car, all models. Truck: E-2E 7, 12..... **\$16.30 ea.**
- 1540922** 1956-66 car, all models except 1963-66 6-cyl. Also, 1963-71 Avanti. Truck: 2E 7, 12 & 3E-6E 2, 7, 12, 13 & 7E-8E 5, 7, 10, 12..... **\$8.75 ea.**
- 1559008** Late 1963-66 6-cylinder. **\$20.25 ea.**

SHIFTER RELATED PARTS

197565 Insulator, shifter lever. 1939-66 with standard transmission. Attaches to lever on transmission. Takes 2 **\$8.00 ea.**



1339524W Retainer ring. 1960-64 Lark or Hawk with 4 speed floor shifter. ... **\$49.00 ea.**

1539489 Insulator, floor shifter lever. 1962-66 car all models & 1963-71 Avanti with automatic transmission. Attaches to lever on transmission.... **\$8.00 ea.**

1552793 Shifter rod, low & second. 1961-64 Lark & Hawk with 4-speed **\$8.00 ea.**

1552811 Reverse shifter rod. 1961-64 Lark & Hawk with 4-speed. **\$15.00 ea.**

1552923 Spring, 4-speed shifter lever, anti rattle, 1961-64 all models, including Avanti. **\$6.50 ea.**

1559789 Retainer ring for shifter rubber boot. 1964 Avanti and early Avanti II with 3 or 4 speed transmission. Chrome..... **\$38.00 ea.**

STANDARD TRANSMISSION LEVER SEALS

674869 1947-66 car, all models with T-86, T-90, T-96 & 1963-64 Avanti with 3-speed. Truck: M5 & 2R-2E 5, 7, 10, 12 & 3E-4E 1, 3, 5, 6, 10, 11 & 5E-6E 5, 6, 10. Note: Also fits overdrive only on T-85. **\$7.00 ea.**

684881 1956-58 car with T-85. 1959-64 T-89. 1961-64 car & 1963-64 Avanti T-10 4-speed..... **\$2.00 ea.**

STANDARD TRANSMISSION REAR SEALS

- 198779** 1940-46 Champion, 1941-42 Commander & President. Truck: M-series with overdrive **\$20.50 ea.**
- 678953** 1931 President & 1941-64 truck with 4-speed transmission, except transmissions made by New Process **\$25.00 ea.**
- 1541097** 1938-40 President with overdrive. 1938-40 Commander & Champ with overdrive 1938-40 all without overdrive, 1947-54 car, all models with standard or overdrive. 1955-57 with T-86 or T-96. Truck: M5 & 2R-8E 1, 2, 3, 5, 6, 7, 10, 11, 12, single lip (Replacement). **\$13.00 ea.**
- 1545164** 1959-64 standard with T-89 & 1958 overdrive with T-85 **\$13.00 ea.**
- 1553737** 1958-66 car, all models & 1963-64 Avanti with 3-speed & T-86, T-90, T-96 standard or overdrive..... **\$10.00 ea.**
- 1555257** 1961-64 car & 1963-64 Avanti with T-10 4-speed..... **\$5.50 ea.**

AUTOMATIC TRANSMISSION FILTER SCREEN

529767 All 1950-55 except DG 250 **\$30.00 ea.**



1545195 1956-66 car, all models & 1963-71 Avanti. Truck: 1956-64. Includes 1540935 pan gasket..... **\$51.00 ea.**

RUBBER AUTOMATIC TRANS. FILLER COVER

1328759X1..... 1958-60 Lark..... black
1328759X2..... 1958 sedan..... blue
1328759X3..... 1958 sedan..... green
1328759X4..... 1958 sedan..... brown
1328759X5..... 1959 Lark..... gray
1328759X6..... 1959 Lark..... blue
1328759X7..... 1959 Lark..... green
1328759X9..... 1960 Lark..... blue
1328759X10..... 1960 Lark..... green
1328759X11..... 1959 Lark..... brown
 **\$35.00 ea.**

AUTOMATIC TRANSMISSION GASKET & "O" RING SETS



534543 Gasket set. 1950-54 car, all models & 1955 V-8 with DG-200 transmission ... **\$89.75 ea.**

535644 Gasket set. 1955 6-cyl car with DG-150 transmission **\$60.00 ea.**

537813 Gasket set. 1955 V-8 car with DG-200M & DG250M transmission..... **\$60.00 ea.**

537955 Gasket set. 1955-56 6-cyl car with DG-150M transmission..... **\$60.00 ea.**

1539122 O-ring kit, without 529646 MDC piston inner seal. All 1950-55 car. 1956 Champion & truck with DG automatic transmission.. **\$95.00 ea.**

1541703 Gasket & O-ring set. 1956-58 Champion 6-cylinder..... **\$60.00 ea.**

1541704 Gasket & O-ring set. 1956-58 8-cylinder. (A52-7A) **\$75.00 ea.**

1555510 Gasket & O-ring set. 1959-60 6-cylinder. Pictured..... **\$46.00 ea.**

1555511 Gasket & O-ring set. 1961- early 63 6-cylinder..... **\$46.00 ea.**

1555512 1961-64 6-cylinder. Heavy duty..... **\$75.00 ea.**

1555513 Gasket & O-ring set. 1959-64 V-8 with column shift..... **\$75.00 ea.**

1557608 Gasket & O-ring set. 1963-64 V-8 car with floor shift) & 1963-71 Avanti. **\$75.00 ea.**

1560127 Gasket & O-ring set. Late 1963-66 6-cylinder..... **\$56.00 ea.**

AUTOMATIC TRANSMISSION OVERHAUL KITS



Kits Include:

- Gasket set
- "O" Ring set
- Front seal
- Rear seal
- Front clutch discs
- Rear clutch discs
- Complete clutch plate set. Includes related rings & retainers.



1565184 1959-60 6-cylinder. Is also adaptable for 1961-early 1963 6-cylinder by substituting later gasket set **\$195.00 ea.**

1565186 1961- early 1963 6-cylinder..... **\$195.00 ea.**

1565187 Late 1963-66 6-cylinder with model 35 transmission..... **\$195.00 ea.**

AUTOMATIC TRANSMISSION PAN GASKETS

527783 1950-55 car, all models..... **\$11.45 ea.**

1540935 1956-66 V-8 car, all models & 1963-71 Avanti. 1956-early 63 6-cylinder. Truck: 2E 7, 12 & 3E-6E 2, 7, 12, 13 & 7E-8E 5, 7, 10, 12..... **\$11.00 ea.**

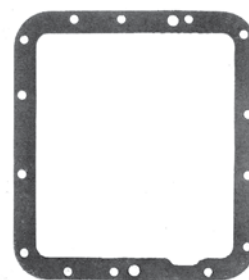

1559148 Late 1963-66 6-cylinder car..... **\$18.50 ea.**

AUTOMATIC TRANSMISSION COOLER FLEX LINE & ELBOWS

G137422 Brass elbow, to radiator & transmission. All models with cooler including Avanti..... **\$15.75 ea.**

189888 Cooler hose. 1957-64 sedan, includes Lark..... **\$21.50 ea.**

531013 Spacer, cooler tube to oil pan..... **\$1.50 ea.**

535284 All 1957- 58 V-8 Hawks. Cooler hose... **\$23.30 ea.**

1557450 Cooler hose. 1963-64 Hawk, 1963-85 Avanti, inlet or outlet. 1965-66 Lark inlet only..... **\$29.60 ea.**

1559180 Cooler hose. 1965-66 Lark outlet..... **\$16.00 ea.**

AUTOMATIC TRANSMISSION FLEX PLATES

527801 Flex plate reinforcer. 1950-64 car, all models & 1963-64 Avanti..... **\$12.50 ea.**

1539081 Flex plate. 1950-64 car, all models & 1963-64 Avanti..... **\$36.00 ea.**



CLUTCH



681066* Truck: M16, 17 & 2R-3R 6, 11, 14, 16, 17, 28, 38. 10-3/4" X 1-1/8" spline relined..... **\$183.75 Ex.**

800367* 8"X1" spline, standard duty. 1939-60 6-cylinder Champion. Pictured..... **\$176.75 Ex.**

800368* 8.5"X1" spline. 1939-64 6-cylinder..... **\$122.00 Ex.**

800369 9.125"X1" spline. 1955-66 6-cylinder. NOS - various. (Core charge - \$100.00)..... **\$150.00 Ex.**

REBUILT CLUTCH DISCS

800370 10"X1-1/8" spline. 1955-64 V-8. (Core charge - \$100.00)..... **\$190.00 Ex.**

800371* 10.5"X1-1/8" spline. 1957-64 V-8 including Avanti. Truck: 1955-64 V-8..... **\$124.90 Ex.**

800372* 9.25"X1-1/8" spline. 1936-37 Dictator, 1938-50 Commander & 1951-54 V-8. Truck: 1949-64 6-cyl **\$157.50 Ex.**

1686260* Truck: 1957-64 V-8. 11"..... **\$245.00 Ex.**

**All sold Rebuilt, exchange unless otherwise indicated. We must receive your old clutch disc first.*

NOTE: We reserve the right to change core charges and pre-send policies according to the availability of rebuildable clutch discs.

NOS CLUTCH DISCS

1564394 1965-66 V-8..... **\$85.00 ea.**

1564412 Standard. 1965-66 194 6-cylinder..... **\$78.00 ea.**

1565520 Heavy Duty. 1965-66 194 6-cylinder.. **\$85.00 ea.**

1565916 Standard. 1966 230 6-cylinder..... **\$95.00 ea.**

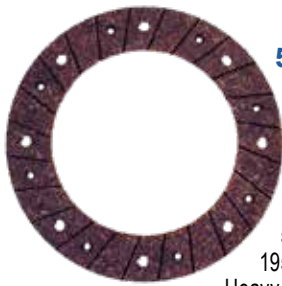

513444 1947-54 Champion. 1959-60 6-cylinder. 8".....**\$47.90 pr.**

535515 1955-58 Champion. 1959-61 6-cyl. Heavy Duty. 9-1/2".....**\$39.95 pr.**

536335 1955-57 259 V-8. 10".....**\$53.00 pr.**

678010 Truck: 2R-3R all except 5, 10, 15. 10-3/4".....**\$76.50 pr.**

683843 1956-57 President & Golden Hawk. 1956-57 289 V-8. Truck: E-2E all except 5, 10, 15. 3E-5E 3, 6, 14, 16, 17. 3E-5E 11 with overdrive or 4-speed trans. 3E-6E 2, 7, 12, 13, 28, 38. 7E-8E 5, 10. 10-1/2".....**\$59.95 pr.**

1539022 1956-57 Commander & President, 1957-58 Golden Hawk. 10-1/4".....**\$59.95 pr.**

CLUTCH FACINGS

1542385 1957-58 289 V-8. 1959-60 6-cyl heavy duty. 1959-61 V-8 heavy duty, 1957-58 Golden Hawk. 10-1/2".....**\$59.95 pr.**

1543129 1957-64 259 V-8. 10-1/4".....**\$49.95 pr.**

1545961 1958 Champion. 8-1/2".....**\$39.95 pr.**

1546601 1958 Champion. 9-1/4".....**\$39.95 pr.**

1548295 1959-60 6-cylinder. Heavy duty front plate. 9-1/4".....**\$19.95 ea.**

1548296 1959-60 6-cylinder. Heavy duty rear plate. 9-1/4".....**\$19.95 ea.**

1688095 Truck: 3E-6E 2, 7, 12, 13, 28, 38, 40. & 7E-8E 7, 12, 13, 28, 40. 12".....**\$69.95 pr.**

1694871 Truck: 7E-8E 15, 25, 35, 45. 13".....**\$79.95 pr.**

1695541 Truck: 7E-8E 13, 28, 40. 12".....**\$79.95 pr.**

BEARING RETAINER KIT

(Clutch Shaft)

532200 1942-54 car. Truck: 1949-59 all and 1960-64 Models 13 thru 45.....**\$23.00 ea.**



CLUTCH RELEASE BEARING ASSEMBLY

195402 1939-42 President. Truck: M16-M17. 2-R-3R 6, 11, 14, 16, 17, 28, 38 (without collar).....**\$64.75 ea.**



198118 1939-64 6-cylinder Champion and Lark 6.....**\$73.95 ea.**

1550534 1934-50 Commander. 1951-64 V-8 car, all models including Avanti. Truck: M5 15, 15A & 2R-3R 5, 10, 15 & 3E-6E all & 7E-8E 5, 7, 10, 12, 13, 28, 40.....**\$157.50 ea.**

1550572 Same as 1550534 but has grease fitting. Heavy duty. (Requires a 1548805 hose to re-grease).....**\$90.00 ea.**

1564753 1965-66 all.....**\$45.00 ea.**

CLUTCH RELEASE BEARING SHAFT & LEVERS

(See Chassis Parts Book Illustration #s)

678604 Shaft & lever. Truck: 2R - 2E 5, 10, 15. 3E- 4E 1, 5, 110. (0203-11).....**\$41.50 ea.**

680940 Shaft & lever. Truck: 2R-4E 1, 5, 10. (0206-1).....**\$36.25 ea.**

682824 Shaft & lever, for 4-speed transmission. Truck: 3R - 2E 6, 11, 14, 16, 17, 3E - 4E 3, 6, 11. (0203-11).....**\$40.00 ea.**

1553490 Shaft & lever. 1961 6-cylinder car after engine S-185, 257. (0203-11).....**\$36.00 ea.**

1554440 Shaft & lever. 1962-64 6-cylinder car. (0203-11).....**\$36.00 ea.**

1692284 Shaft & lever. Truck: 5E 6, 11, with 3 speed transmission. (0203-11).....**\$40.00 ea.**

NOTE: Additional Shafts and levers for 1933 - 1958 cars are listed by car on the following three pages.

CLUTCH PRESSURE PLATES

664076* Rebuilt. Truck: M16, 17 & 2R-3R 6, 11, 14, 16, 17, 28, 38. 10 3/4' diameter.....**\$367.50 Ex.**

800374* Rebuilt. 1939-60 6-cylinder Champion. 8" diameter.....**\$227.50 Ex.**

800375* Rebuilt. 1939-64 6-cylinder car. 8.5" diameter.....**\$236.50 Ex.**

800376 Rebuilt. 1951-54 V-8 car, 1940-50 Commander 6-cylinder & 1955-64 6-cylinder 9.25" diameter. Truck: 1941-64 6-cylinder. (Core charge - \$100.00).....**\$201.25 Ex.**

800377* Rebuilt. 1955-64 V-8 car. 10" diameter.....**\$120.00 Ex.**

800378* New, while supplies last. 1957-64 V-8 car. 10.5" diameter. Truck: 1955-64 V-8. Standard duty.....**\$181.20 ea.**

1565518 1965-66 194 6-cylinder. Heavy duty. NOS.....**\$95.00 ea.**



1687116* Rebuilt. Truck: 1957-64 V-8 with 11" diameter.....**\$289.00 Ex.**

***All sold Rebuilt, exchange unless otherwise indicated. We must receive your old clutch pressure plate first**

CLUTCH ADJUSTING ROD

1551507 Rod, clutch adjustment. 1961-64 Lark. Pictured.....**\$18.00 ea.**

1552292 Rod, bell-crank to pedal adjustment. 1961-64 Lark.....**\$16.00 ea.**

1560969 Rod, clutch adjustment. 1963-64 Avanti.....**\$39.00 ea.**

STARTER GEAR RINGS

525271 1950-54 Champion 6-cylinder with standard transmission. Truck: 2R, 3R, E, 2E 5, 10, 15, 3E-6E 1, 5, 10, 7E 5, 10, without automatic transmission.....**\$95.00 ea.**

1539744 1956-64 V-8 with automatic transmission.....**\$61.25 ea.**

1539745 1955-64 V-8 including Avanti with standard transmission. Truck: 2E all except 5, 10, 15. 3E-6E all except 1, 5, 10 & E-8E 5, 7, 12, 28, 40.....**\$89.50 ea.**

1539747 1955-64 Champion 6-cylinder with standard trans. Truck: 4E 1, 5.....**\$90.00 ea.**

BELL HOUSING PARTS

196420 Dowel to engine plate. 1939-46 Champion. Takes 2.....**\$7.30 ea.**

511708 Bushing, bronze. 1934-39 car, all models except Champion.....**\$5.50 ea.**

527420 Bushing, bronze. 1939-46 Champion.....**\$6.60 ea.**

527421 Bushing, bronze. 1940-42 Commander & 1941-42 President.....**\$5.50 ea.**

1549243 Shield. Lower bell housing. 1951-64 V-8.....**\$12.90 ea.**

PRE-WAR CLUTCH LINKAGES

1933-46 All Typical

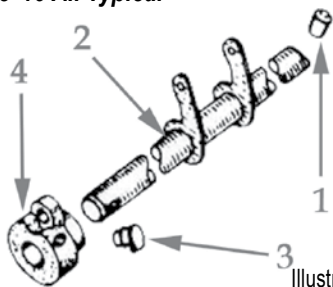

Illustration, Trans.-1

1936 All Models

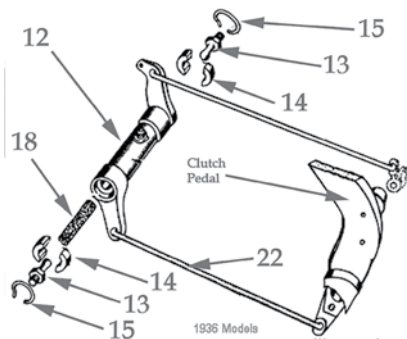

Illustration, Trans.-2

1937 All Models

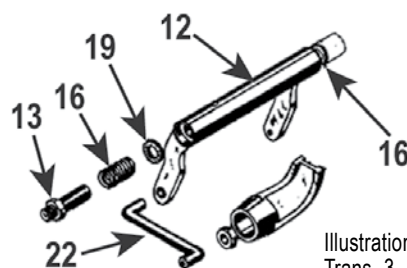

Illustration, Trans.-3

1938-40

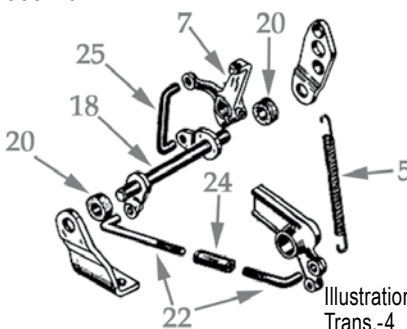

Illustration, Trans.-4

1939-46 Champion 1941-42 All Models

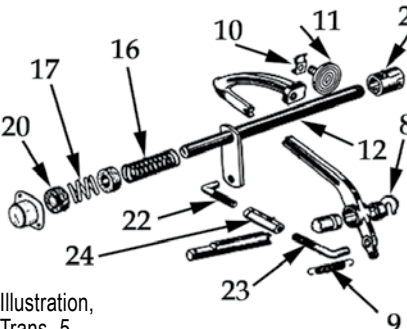

Illustration, Trans.-5

- (1) **512766** Oiler. 1939-46 Champion, 1941-42 Commander & President **\$3.50 ea.**
- (2) **510173** Shaft & Levers. 1934-35 Dictator **\$60.00 ea.**
- (2) **189218** Shaft & Levers. 1937 Dictator & Coupe Express **\$60.00 ea.**
- (2) **191786** Shaft & Levers. 1938-40 Commander & President **\$30.00 ea.**
- (2) **199228** Shaft & Levers. 1941-42 Commander & President **\$30.00 ea.**
- (2) **194644** Shaft & Levers. 1939-40 Champion **\$80.00 ea.**
- (2) **514070** Shaft & Levers. 1941-46, all models **\$84.00 ea.**
- (3) **512761** Oiler. 1941-46, all models .. **\$3.50 ea.**
- (4) **187481** Bushing & retainer. 1936-37 Dictator & Coupe Express **\$24.95 ea.**
- (4) **512758** Bushing & retainer. 1941-42 Commander & President **\$24.95 ea.**
- (4) **196080** Bushing & retainer. 1939-40 Champion **\$24.95 ea.**
- (4) **512755** Bushing & retainer. 1941-46 Champion **\$15.00 ea.**
- (5) **191828** Spring. 1938-40, all models except Champion **\$9.40 ea.**
- 187483** Lever, inner. 1936, all cars **\$22.50 ea.**
- 191223** Set screw. Late 1937 car. 3/8" ... **\$2.00 ea.**
- 191236** Set screw. Early 1937 car. 5/16" **\$2.00 ea.**
- (7) **192181** Lever, outer. 1938-39, all models except Champion **\$32.95 ea.**
- (8) **197809** Bushing. 1935-37 Dictator, 1938-40 Commander, 1942 Commander, 1936 President, 1942 President. Takes 2 **\$7.50 ea.**
- (8) **199222** Bushing. 1941 Commander & President. Takes 2 **\$7.50 ea.**
- (8) **194557** Bushing. 1939-46 Champion. Takes 2 **\$9.35 ea.**
- (9) **510434** Spring. 1934-35 Dictator... **\$9.40 ea.**
- (9) **199435** Spring. 1941-42 Commander & President **\$5.30 ea.**
- (9) **197476** Spring. 1939-40 Champion **\$7.20 ea.**
- (9) **198877** Spring. 1941-46 Champion **\$5.30 ea.**
- (9) **631469** Clip for pullback spring. 1934-35 Dictator **\$1.50 ea.**
- 510426** Retainer for clutch pedal. 1937-40 Dictator, Commander, Coupe Express & President **\$4.35 ea.**
- (10) **513818** Plate, pedal starter switch operating. 1941-42 Commander & 1942 President **\$9.20 ea.**
- (10) **195950** Plate, pedal starter switch operating. 1939-46 Champion **\$9.20 ea.**
- (11) **151606** Clutch pedal pad. 1929-37, all cars .. **\$18.50 ea.**
- (11) **675269** Clutch pedal pad. 1939-46 Champion & 1941-42 Commander & President **\$18.00 ea.**
- 194562** Floor rubber seal for clutch pedal. 1939-46 Champion & all 1941-42 Commander & President **\$5.00 ea.**
- (12) **189232** Shaft. 1937 Dictator & Coupe Express **\$42.50 ea.**
- (12) **189233** Shaft. 1937 President **\$42.50 ea.**
- (12) **191789** Shaft. 1938-40 Commander & President **\$32.95 ea.**
- (12) **195228** Shaft. 1939-40 President **\$14.25 ea.**
- (12) **199230** Shaft. 1941 Commander **\$28.50 ea.**
- (12) **515006** Shaft. 1942 Commander & President **\$28.50 ea.**
- (12) **194650** Shaft. 1939-40 Champion **\$28.50 ea.**
- (12) **198816** Shaft. 1941-46 Champion **\$17.00 ea.**
- (13) **187640** Stud. 1936 Dictator & President. Takes 2 **\$9.75 ea.**
- 189215** Stud. 1937 Dictator **\$12.00 ea.**
- (14) **187641** Seat. 1936 Dictator & President. Takes 4 **\$5.50 ea.**
- (15) **187642** Retainer. 1936 Dictator & President. Takes 2 **\$4.40 ea.**
- (17) **631893** Spring. 1941-42 Commander & President (outer), 1941-46 Champion .. **\$1.50 ea.**
- (16) **196952** Spring. 1939-46 Champion **\$1.50 ea.**
- (18) **187637** Oil wick. 1936 Dictator & President .. **\$3.95 ea.**
- (20) **191409** Oil washer. 1938-40 all models except Champion. Takes 2 **\$3.95 ea.**
- (20) **191409** Oil washer. 1939-40 Champion, inner coil washer on 1941-46 Champion. Takes 1 **\$3.95 ea.**
- (20) **199304** Oil washer. 1941-42 all models except Champion. Takes 2 **\$3.95 ea.**
- (20) **199621** Oil washer (outer) on 1941-46 Champion **\$3.95 ea.**
- (21) **199220** Sleeve. 1941-42 Commander & President **\$30.00 ea.**
- (21) **194643** Sleeve. 1939-46 Champion **\$14.50 ea.**
- 199493** Pin, clevis to shaft. 1941-42 Commander & President **\$3.35 ea.**
- (22) **187646** Rod. 1936 President **\$9.35 ea.**
- (22) **189216** Rod 3 1/2", 1937 Dictator and Coupe Express **\$9.30 ea.**
- (22) **191622** Rod, 4 1/4" long. 1939-40 Commander, Coupe Express & 1938 President **\$9.30 ea.**
- (22) **191623** Rod, 2 1/4" long. 1938-40 Commander & President **\$6.85 ea.**
- (22) **195231** Rod, 3 1/2" long. 1939-40 President **\$6.85 ea.**
- (22) **199480** Rod. 1941 Commander & President **\$9.40 ea.**
- (22) **515019** Rod. 1942 Commander & President **\$9.40 ea.**
- (22) **194601** Rod. 1939-40 Champion .. **\$5.40 ea.**
- (22) **198769** Rod. 1941-46 Champion .. **\$5.25 ea.**
- (23) **199481** Rod. 1941-42 Commander & President **\$9.40 ea.**
- (23) **195551** Rod. 1939-40 Champion .. **\$9.40 ea.**
- (23) **198770** Rod. 1941-46 Champion .. **\$9.30 ea.**
- 194604** Locking nut, rear. 1939-40 Champion **\$2.00 ea.**
- (24) **191618** Turnbuckle. 1938-42 car, all models except Champion **\$9.35 ea.**
- (24) **194603** Turnbuckle. 1939-46 Champion **\$8.70 ea.**
- 191619** Nut, left-hand thread. 1938-42 car, all models except Champion **\$3.20 ea.**
- (25) **191787** Rod. 1938-40 all car, except Champion **\$9.35 ea.**

CLUTCH PEDAL SPRINGS

- 182698** Spring, clutch toggle lever. 1934-42 Dictator & Commander, 1947-54 Commander, 1955-64 most models. See chassis manual. Takes 3  **\$9.75 ea.**
- 184291** Spring washer, clutch operating rods. Most models **\$1.25 ea.**
- 266584** 1941-48 M-Series truck **\$9.50 ea.**
- 284505P** Spring, clutch pedal return. All 1965-66 car **\$9.95 ea.**
- 519432** Spring, pedal pull-back. 1947-52 car, all models **\$19.80 ea.**
- 531049** Spring, pedal pull-back. All 1953-54 **\$14.40 ea.**
- 536330** Spring, pressure plate. 7 coils & green. 1955-60 with 259 V-8 **\$7.25 ea.**
- 536743** Spring, pedal pull-back. 1953-60 all models. 1961-64 Hawk **\$12.00 ea.**
- 1552360** Spring, pedal pull-back. 1961-64 Lark. Truck: 1963-64 Champ **\$18.00 ea.**
-  **1564763** Spring, retaining clutch push rod. 7 coils & green. 1965-66 all models. Pictured, above **\$10.00 ea.**

CLUTCH RELATED PARTS

- 199220** Sleeve, clutch operating shaft. 1947-54 Commander & 1955-64 all models with standard transmission including Avanti **\$30.00 ea.**
- 534175** Pin, clutch operating shaft clevis 1953-66 all models including Avanti **\$3.50 ea.**
- 534872** Boot, clutch operating shaft. 1953-64 all models with standard transmission.. **\$6.00 ea.** 
- 1540227** Shaft, clutch pedal. 1956 Golden Hawk **\$60.00 ea.**
-  **1541533** Swivel, on clutch adjustment rod. All 1959-66 models except Hawk with 4-speed. 1963-64 Avanti. On automatic trans. 1957-66 all models. **\$18.95 ea.**
- 1543914** Bushing, clutch pedal. 1961-66 all models except C & K & 1963-85 Avanti. If your pedal wobbles, these probably need replacing. Takes 2 **\$4.50 ea.** 
-  **1552589** Boot, clutch rod, 1961-66 car all models & 1963-64 Avanti with standard transmission. Truck: 1963-64 Champ .. **\$21.55 ea.**
- 1564751** Boot, clutch release bearing. 1965-66 6-cylinder & V-8 **\$20.00 ea.** 

CLUTCH LINKAGE 1947-52 CARS

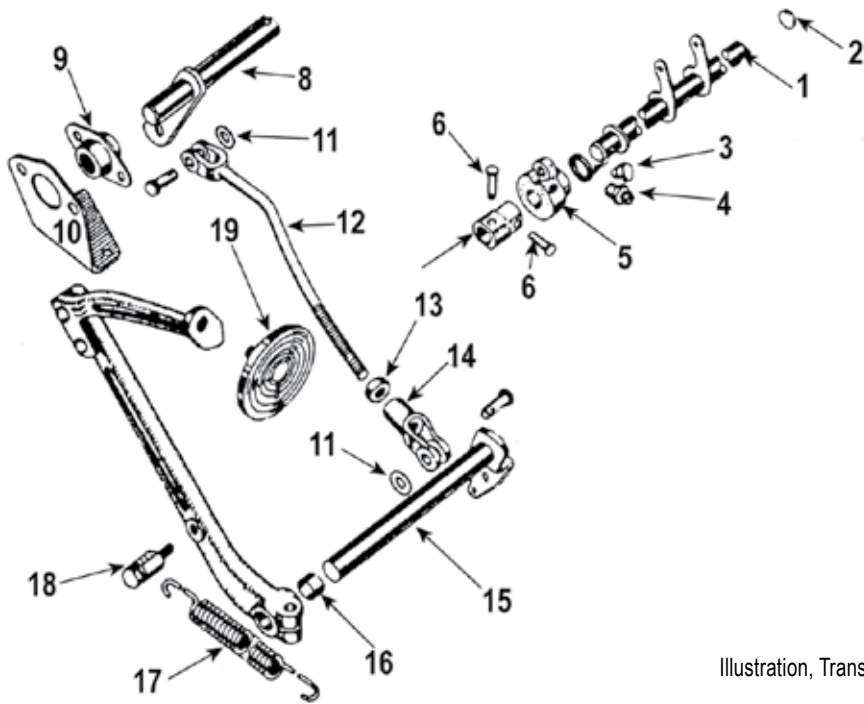

Illustration, Trans.-7

- (1) **524950** Shaft & levers. 1947-52 Champion (order 524848 plug on all 1947-early 1948 cars) **\$45.30 ea.**
- (1) **524951** Shaft & levers. 1947-50 Commander. Order 524849 plug on all 1947 & early 1948 car **\$54.35 ea.**
- (1) **529216** Shaft & levers. 1951-52 all models... **\$46.70 ea.**
- (2) **524848** Plug, original equipment on late 1948-52 Champion **\$2.00 ea.**
- (2) **524849** Plug, original equipment on late 1948-52 Commander **\$2.00 ea.**
- (3) **2082X1** Oiler. 1947-early 1948 **\$1.90 ea.**
- (4) **G110161** Nipple, late 1948-52 all models **\$2.00 ea.**
- (5) **527275** Retainer. 1947-50 Champion **\$28.45 ea.**
- (5) **527278** Retainer. 1947-50 Commander. **\$28.80 ea.**
- (5) **529333** Retainer. 1951-52 Commander. **\$28.50 ea.**
- (6) **522272** Pin. 1947-52 Champion. Takes 2 **\$2.00 ea.**
- (7) **194643** Sleeve. 1947-52 Champion **\$14.50 ea.**
- (7) **199220** Sleeve. 1947-52 Commander **\$30.00 ea.**
- (8) **519447** Shaft & lever. 1947-early 1950 Champion **\$19.80 ea.**
- (8) **527893** Shaft & lever. Late 1950 Champion **\$19.80 ea.**
- (8) **531489** Shaft & lever. 1951-52 Champion **\$19.80 ea.**
- (8) **518289** Shaft & lever. 1947-50 Commander. **\$19.80 ea.**
- (8) **531488** Shaft & lever. 1951-52 Commander. **\$29.85 ea.**
- (9) **532200** Retainer & bearing kit. 1947-52 all... **\$23.00 ea.**
- (10) **520996** Bracket. 1947-49 Champion **\$14.40 ea.**
- (10) **526261** Bracket. Early 1950 Champion **\$14.40 ea.**
- (10) **527911** Bracket, late 1950 Champion **\$14.40 ea.**
- (10) **520234** Bracket. 1947-50 Commander **\$14.00 ea.**
- (10) **529158** Bracket. 1951-52, all **\$14.40 ea.**
- (12) **519493** Rod. 1947- early 1950 Champion... **\$18.00 ea.**
- (12) **527872** Rod. Late 1950 Champion **\$18.00 ea.**
- (12) **519816** Rod. 1947-50 Commander. **\$17.90 ea.**
- (12) **527915** Rod. 1951-52 all **\$27.90 ea.**
- (13) **G103026** Nut. 1947-52 all **\$1.00 ea.**
- (14) **636805** Clevis. 1947-52 all **\$14.40 ea.**
- (15) **519303** Shaft & levers. 1947- early 1950 Champion. **\$23.75 ea.**
- (15) **527871** Shaft & levers. Late 1950 Champion **\$23.75 ea.**
- (15) **529129** Shaft & levers. 1951-52 Champion. **\$19.80 ea.**
- (15) **519832** Shaft & levers. 1947-50 Commander **\$19.80 ea.**
- (15) **529331** Shaft & levers. 1951-52 Commander **\$24.30 ea.**
- (16) **194557** Bushing. 1947-52, all. Takes 2. **\$9.35 ea.**
- (17) **519432** Spring. 1947-52, all. **\$19.80 ea.**
- (18) **517404** Stud. 1947-52, all. **\$10.00 ea.**
- (19) **675269** Pedal pad. 1947-52 all... **\$18.00 ea.**

CLUTCH LINKAGE 1953-1958 CARS

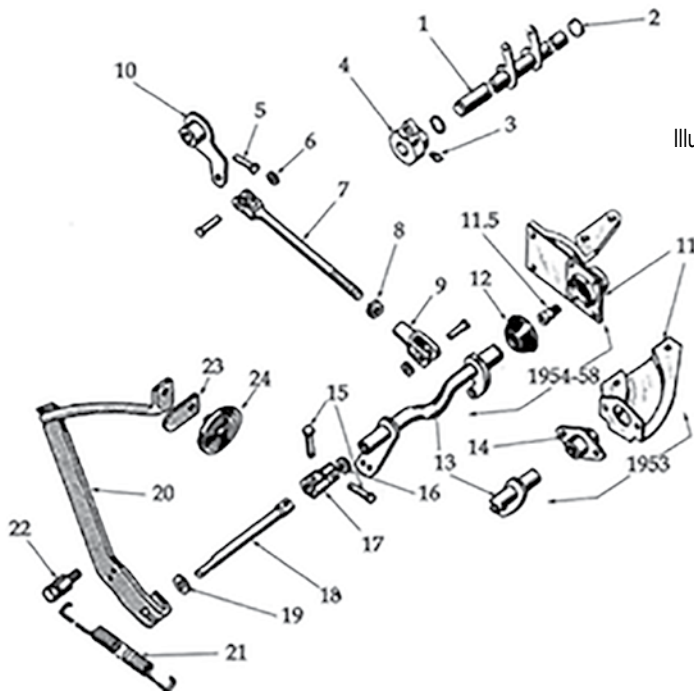

Illustration, Trans.-8

- (1) **532031** Shaft and levers. 1953-54 Champion.\$42.00 ea.
- (1) **531997** Shaft and levers. 1953-54 Commander.\$39.20 ea.
- (1) **535692** Shaft and levers. 1955-58 Champion.\$39.20 ea.
- (2) **524848** Plug. 1953-58 Champion.\$2.00 ea.
- (2) **524849** Plug. 1953-58 Commander.\$2.00 ea.
- (4) **527275** Retainer. 1953-54 Champion.\$28.45 ea.
- (4) **535951** Retainer. 1955-58 Champion.\$25.40 ea.
- (4) **529333** Retainer. 1953-58 Commander.\$28.50 ea.
- (5) **522272** Pin. 1953-54 Champion.\$2.00 ea.
- (5) **42X102** Pin. 1955-58 Champion all V-8.\$1.50 ea.
- (7) **532034** Rod. All 1953-58 except C-body coupe and K-body hardtop and any 1958 with Clevis type end.\$21.35 ea.
- (7) **531992** Rod. All 1953-58 C & K except 1956 Golden Hawk.\$60.00 ea.
- (8) **G120369** Nut. All 1955-58 except 1956 Golden Hawk.\$1.00 ea.
- (10) **532045** Lever. 1953-54 Champion.\$29.00 ea.
- (10) **532051** Lever. 1953-54 Commander and 1955-58 Champion.\$33.45 ea.
- (10) **536306** Lever. All 1955-58 V-8 except 1957 Packard & 1956-57 4-door President w/long wheel base & overdrive.\$25.40 ea.
- (11) **532053P** Bracket. 1953 Champion sedan.\$12.00 ea.
- (11) **532123P** Bracket. 1953 Champion coupe and hardtop.\$11.75 ea.
- (11) **535329** Bracket. All 1954-58 Champion except coupe and hardtop.\$35.00 ea.
- (11) **535330** Bracket. 1954-58 Champion coupe and hardtop.\$42.00 ea.
- (11) **532039** Bracket. 1953 Commander sedan.\$44.80 ea.
- (11) **535331** Bracket. All 1954-57 Commander except coupe, hardtop and 1956-57 4-door long wheel base President with overdrive.\$39.00 ea.
- (11.5) **534833** Ball stud. All 1954-58. Includes #11 bracket.\$17.80 ea.
- (12) **534872** Boot. All 1954-58.\$6.00 ea.
- (13) **532054** Shaft & Levers. All 1953.\$46.80 ea.
- (13) **1546329** Shaft & Levers. All 1954 Champion except sedan with overdrive. All 1955 car without overdrive. All 1956-57 6-cylinder, all 1956-57 V-8 except long wheel base sedan with overdrive. Also used on all 1958 V-8 except Golden and Packard Hawk.\$34.40 ea.
- (13) **1539422** Shaft and levers. 1956 Golden Hawk.\$75.00 ea.
- (13) **537108** Shaft and levers. 1954-55 Champion sedan with overdrive.\$75.00 ea.
- (14) **532200** Bearing and retainer kit. All 1953.\$23.00 ea.
- (15) **534175** Pin. All 1953-58. Takes 2.\$3.50 ea.
- (16) **533933** Washer. All 1953-58.\$3.90 ea.
- (17) **199220** Sleeve. All 1953-58.\$30.00 ea.
- (18) **533188** Shaft. All 1953-58.\$21.35 ea.
- (19) **532035** Washer. All 1953-58.\$2.00 ea.
- (20) **532010** Pedal. All 1953-54.\$41.60 ea.
- (20) **536147** Pedal. All 1955-58.\$32.90 ea.
- (21) **531049** Spring. All 1953-54.\$14.40 ea.
- (21) **536743** Spring. All 1955-58.\$12.00 ea.
- (22) **517504** Stud. All 1953-54.\$6.00 ea.
- (23) **530561** Plate. All 1953-54.\$2.80 ea.
- (24) **675269** Pad. All 1953-54.\$18.00 ea.
- (24) **537288** Pad. All 1955-58.\$22.00 ea.

STANDARD TRANSMISSION FRONT BEARINGS

188494 1936-37 Dictator & 1939-46 Champion.\$95.00 ea.



192302 1938-42 Commander & President. 1947-54 car, all models. 1955 with T-86 or T-96. Truck: M5.\$55.00 ea.

630363 Truck: M5-M17 & 2R-2E all with T-9 & T-9A.\$72.00 ea.

681682 Truck: 2R-8E all with T-98 & T-98A.\$95.00 ea.

1540395 1959-66 car with T-86 or T-96. Truck: M5 & 2R-2E 5, 7, 10, 12 & 3E-8E 1, 3, 5, 6, 10, 11.\$107.00 ea.

1541089 1956-58 V-8 car with T-85 & 1959-64 V-8 car with T-89. 1961-64 car & 1963-64 Avanti with T-10 4-speed. Truck: 3E-4E 2, 7, 12 & 5E-8E 7, 11.\$84.00 ea.

1546150 1958-64 6-cylinder car with T-90.\$137.45 ea.

1565324 1934-35 Dictator & Commander & 1934-37 President. 1965-66 6-cylinder car with T-90.\$151.25 ea.

STANDARD TRANSMISSION REAR BEARINGS

122825 1956-58 V-8 car with T-85. 1959-64 V-8 with T-89. Truck: All M5-M17 with 4-speed & 3E-8E 2, 7, 12 with 3-speed.\$148.10 ea.



134030 1939-54 Commander & President. 1955-58 V-8 with T-86. Truck: 2R-2E 5, 7, 10, 12 & 3E-6E 1, 3, 5, 6, 10, 11.\$49.00 ea.

197276 1939-54 Champion.\$61.15 ea.

513273 1955-58 6-cylinder with T-96.\$38.00 ea.

639512 Truck: All 2R-6E with T-98A & 7E-8E 5, 7, 10, 12, 13, 28, 40 with T-98A 4-speed.\$55.00 ea.

1540395 1959-64 V-8 car & 1963-64 Avanti with T-86. 1965-66 with T-86 and overdrive. Truck: 7E-8E 5, 10.\$107.00 ea.

1541089 1961-64 car, all models with 4-speed, including Avanti.\$84.00 ea.

1542951 1939-54 6-cylinder with overdrive. 1955-64 6-cylinder with T-96 and overdrive.\$44.50 ea.

1549333 1958-66 6-cylinder car with T-96.\$72.00 ea.

1556345 Bushing. T-10 4-speed. 1961-64 car including Avanti.\$15.00 ea.

1565325 1958-66 6-cylinder with T-90.\$85.00 ea.

1963-64 AVANTI

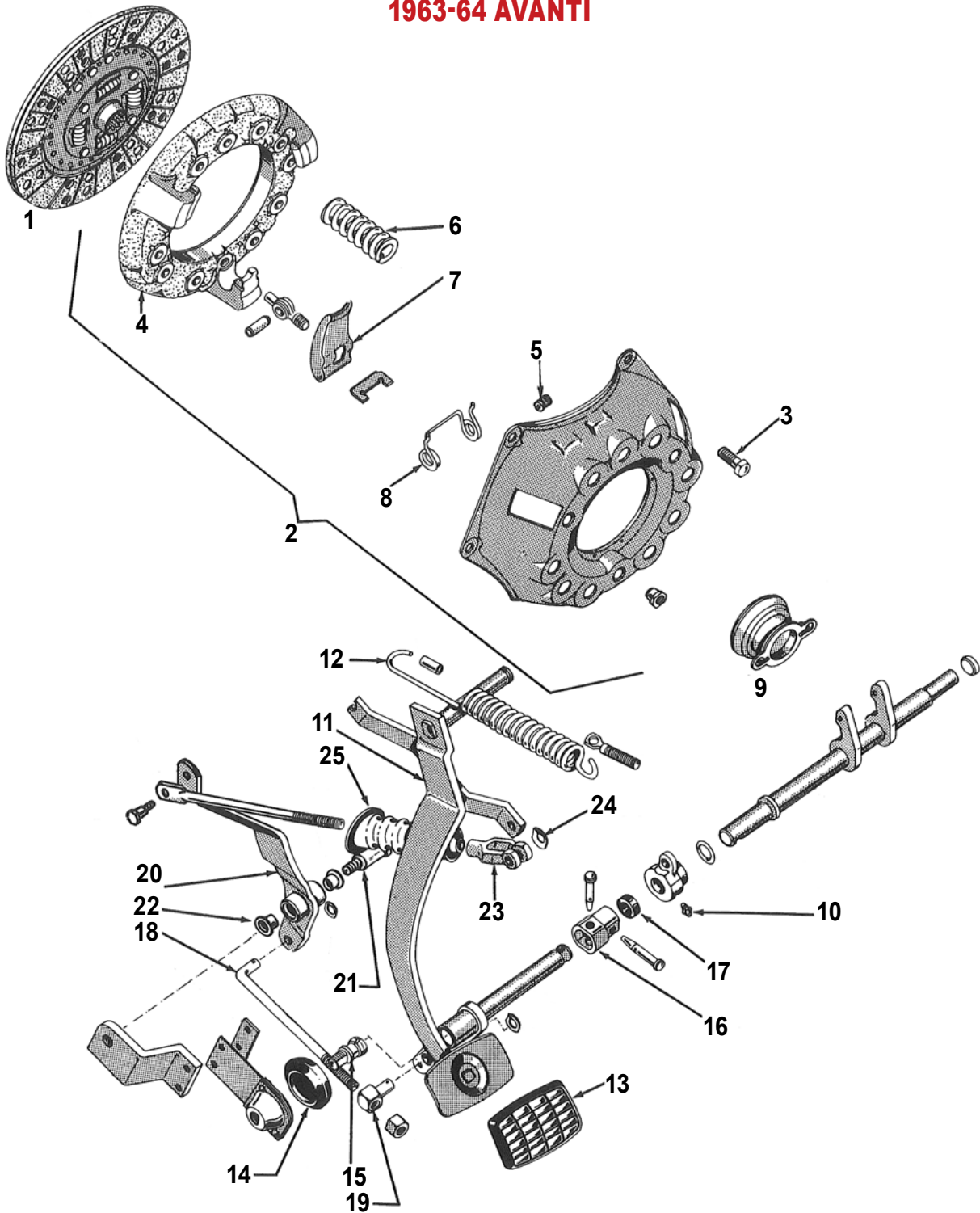

- | | | |
|--|---|---|
| 1) 800371 Clutch disc \$124.90 ea. | 7) 1560643 toggle lever for pressure plate models 1658 and 1677..... \$17.00 ea. | 16) 683833 sleeve..... \$25.00 ea. |
| 2) 800378 Pressure plate (only standard duty available) \$181.20 ea. | 8) spring..... \$9.75 ea. | 17) 533933 washer \$3.90 ea. |
| 3) 195227 screw to flywheel \$27.20 set/6 | 9) 1550534 release bearing, includes bearing, collar, spring, and plate..... \$157.50 ea. | 18) 1560969 rod..... \$39.00 ea. |
| 4) 1557491 plate for pressure plate model numbers 1610 and 1658 \$145.00 ea. | 10) 3176x1 grease fitting \$1.50 ea. | 19) 1541533 swivel..... \$18.95 ea. |
| 5) 1553132 roller \$17.00 ea. | 11) 1554070 clutch pedal & shaft ... \$85.00 ea. | 20) 1552287 bellcrank..... \$58.00 ea. |
| 6) 531577 spring for pressure plate models 1610 and 1658, takes 9..... \$15.50 ea. | 12) 1552360 pull back spring \$18.00 ea. | 21) 1552299 pivot pin \$26.00 ea. |
| 7) 1552562 toggle lever for pressure plate models 1610 and 1614..... \$17.00 ea. | 13) 1552334 pedal pad..... \$18.00 ea. | 22) 1543914 bushing..... \$4.50 ea. |
| | 14) 524972 operating shaft boot \$6.00 ea. | 23) 1544246 clevis \$19.00 ea. |
| | 15) 534833 ball stud..... \$17.80 ea. | 24) 184291 washer \$1.25 ea. |
| | | 25) 1552589 boot..... \$21.55 ea. |

BELOW: Wendy Lee's 1947 Champion Starlight Coupe from Fair Oaks, California



OVERDRIVE RELAYS

523297 Overdrive relay. 6-volt. 1947-55 car & truck
\$117.95 ea.

1539595 12-volt 1956 car & truck.
\$117.95 ea.

1542260 12-volt 1957 car & truck. NOS.
\$150.00 ea.



OVERDRIVE SHAFT BEARINGS

134030 1936-37 Dictator. 1956 V-8 car with T-85. Truck: 3E-6E 2, 7, 12.....
\$49.00 ea.

192302 1958 car, all models.....
\$55.00 ea.

513273 1941-42 Commander & President. 1941-46 Champion. Truck: early M5.....
\$38.00 ea.

531584 1951-54 car, all models. 1955 with T-86 and T-96. Truck: 2E 5, 7, 10, 12 & 3E-6E 1, 3, 5, 6, 10, 11 & 7E-8E 5, 10.....
\$54.80 ea.

1540395 1959-66 car, all models. Truck: 7E-8E 7, 12.....
\$107.00 ea.

1542951 1939-40 car, all models. 1947-50 all models, 1956-57 with T-86 and T-96. Truck: Late M5 & 2R-2E 5, 7, 10, 12.....
\$44.50 ea.

OVERDRIVE LOCKOUT CABLES

519261 Sleeve & tube. 1947-49 Champion.....
\$18.00 ea.

520362 Sleeve & tube. 1947-49 Commander.....
\$13.25 ea.

522805 Button & wire. All 1947-48 car and will also fit all 1949 car. Trucks: 2R-2E.....
\$45.00 ea.

526114 Button & wire. All 1950-52 & 1956 car..
\$40.00 ea.

532615X2 Button & wire. All 1953-55 car.....
\$38.40 ea.

532614X1 sleeve & tube. 1953- early 1955 car.....
\$18.00 ea.

537669X1 sleeve & tube. Late 1955-57 car.....
\$18.00 ea.

OVERDRIVE SOLENOID



1539359 All 1964 - 66. NOS.....
\$175.00 Ex.

1545215 All 1958-64 with three terminal solenoid. Rebuilt.....
\$180.00 Ex.

OVERDRIVE SOLENOID PAWL OPERATING ROD SEAL

196183 1939-42 Commander & President. 1939-46 Champion. 1947-66 car, all models with overdrive. Truck: M5, 2R-6E 5, 7, 10, 12 & 3E-6E 1, 3 & 7E-8E 5, 7, 10, 12.....
\$5.00 ea.

BOOT, OVERDRIVE GOVERNOR

522022 All 1947-57 models with overdrive transmission.....
\$6.50 ea.

Overdrive Governors Call for Availability and Price

OVERDRIVE KICK DOWN SWITCHES



529479 1941-60 car, all models. Truck: M5 & 2R-5E 1, 2, 3, 5, 6, 7, 10, 11...
\$39.50 ea.

532896 1953-55 Commander. 1955 President....
\$28.00 ea.

1551253 1961-64 car. Truck: 6E - 8E, 5, 7, 10, 12.....
\$75.00 ea.

1564000 1965-66 Lark.....
\$48.00 ea.

OVERDRIVE LOCKOUT SWITCHES

521436 All 1947-55 car. Truck: M5-2R-E 5, 6, 7, 10, 11, 12.....
\$63.00 ea.

521437 Gasket...
\$3.00 ea.



SYNCHRONIZER BLOCKING RINGS



197306 T-96 second & high. 1939-58 Champion. 1959-64 Lark 6-cylinder.....
\$28.00 ea.

458449 T-10 4-speed. All 1961-64 car including 1963-64 Avanti, low & second, third & high. T-85 3-speed. All 1956-58 car including 1963-64 Avanti, second & high.....
\$38.00 ea.

1555429 1939-66 all models with T-86, T-89, or T-90 transmission.....
\$38.00 ea.

TRANSMISSION WITHOUT OVERDRIVE

1939-46 Sixes & Eights
(2) **197256** Gasket. 1939-46 Champion.....
\$2.40 ea.

(2) **198964** Gasket. 1940-42 all except Champion.....
\$2.40 ea.

(3) **193060** Flange. 1940-42 all except Champion.....
\$70.00 ea.

(3) **197287** Flange. 1939-46 Champion.....
\$45.30 ea.

(4) **188298** .0135 gasket. All 1940-42 except Champion.....
\$6.70 ea.

(4) **192306** .025 gasket. All 1940-42 except Champion. Available only in 800380-1546282 gasket set.....
\$6.75 ea.

(4) **197234** Gasket. 1939-46 Champion.....
\$6.70 ea.

Note: See bottom of page 256 in 1934-46 Chassis Parts book for exact application.

(5.1) **197273** Bearing. All 1939 & early 1940 Champion without overdrive.....
\$28.30 ea.

(5.1) **513258** Bearing. All 1941-42 car without overdrive except Champion.....
\$28.30 ea.

(6A) **188279** Gasket. All 1940 except Champion.....
Order S-632 Gasket set

(6A) **197246** Gasket. 1939-40 Champion without overdrive.....
Order S-628 Gasket set

(6A) **512984** Gasket. 1941-46 Champion without overdrive.....
Order S-629 Gasket set

(6B) **513075** Gasket. All 1941-42 car without overdrive except Champion.....
\$4.40 ea.

(7) **197269** Seal, rear transmission. All 1939 - early 1940 Champion without overdrive.....
\$21.80 ea.

(7) **198779** Seal, rear transmission. 1940 Champion and all 1941-46 car without overdrive.....
\$20.50 ea.

(7) **1541097** Seal, rear transmission. All 1940 car without overdrive except Champion.....
\$13.00 ea.

(8) **196141** Main shaft. All 1940 car without overdrive except Champion.....
\$82.00 ea.

(8) **197285** Main shaft. 1939- early 1940 Champion without overdrive.....
\$121.50 ea.

(8) **198784** Main shaft. Late 1940 Champion without overdrive.....
\$121.50 ea.

(8) **512989** Main shaft. 1941 Champion without overdrive.....
\$121.50 ea.

(8) **513256** Main shaft. All 1941 except Champion without overdrive.....
\$121.50 ea.

(10) **197376** Gear, low and reverse. 1939-40 Champion.....
\$81.40 ea.

(10) **512996** Gear, low and reverse. 1941-46 Champion.....
\$81.40 ea.

(11) **196143** Gear, 2nd. 1940-42 Commander & President.....
\$69.40 ea.

(11) **197288** Gear, 2nd. 1939-46 Champion.....
\$75.00 ea.

188348 Snap ring, 2nd gear. 1940 Commander & President.....
\$5.70 ea.

(12) **516732** Synchronizer, without blocking rings. 1939-46 Champion.....
\$74.50 ea.

(13) **198967** Gear, 2nd & high synchronizer. All 1940-42 except Champion.....
\$38.90 ea.

(13) **514449** Gear, 2nd & high synchronizer. 1939-46 Champion.....
\$43.60 ea.

(14) **188348** Snap ring. All 1941-42 except Champion.....
\$5.70 ea.

(14) **197230** Snap ring. 1939-46 Champion.....
\$5.40 ea.

(15) **197305** Sleeve. 1939-46 Champion.....
\$39.80 ea.

(15) **198968** Sleeve. 1940-42 all except Champion.....
Available only as part of Synchronizer Assembly.

(16) **197271** Plate, shifter. 1939-46 Champion. Takes 3.....
\$2.80 ea.

(16) **198970** Plate. All 1940-42 except Champion. Takes 3.....
\$10.00 ea.

(17) **198971** Snap ring. All 1940-42 except Champion. Takes 2.....
\$6.40 ea.

(17) **199111** Snap ring. 1939-46 Champion. Takes 3.....
\$5.40 ea.

(18) **197306** Blocking ring. 1939-46 Champion. Takes 2.....
\$28.00 ea.

(19) **188295** Roller. All 1940-42 except Champion. Takes 14.....
\$3.25 ea.

(19) **512990** Roller. 1941-46 Champion. Takes 13.....
\$1.50 ea.

(20) **134030** Bearing. All 1940-42 except Champion.....
\$49.00 ea.

TRANSMISSION LESS OVERDRIVE 1939-46 SIXES & EIGHTS

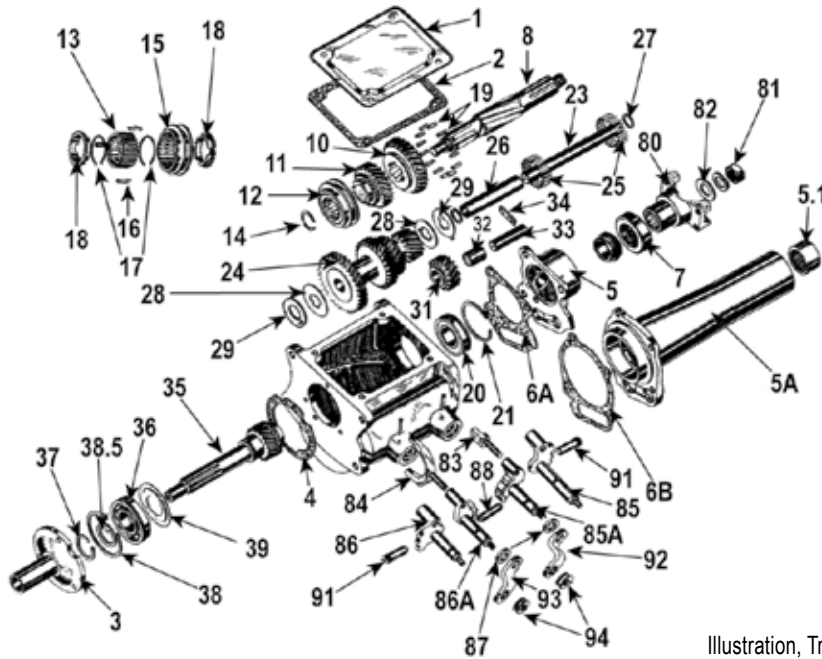

Illustration, Trans.-9

- | | | | | | |
|---|---------------------|--|---------------------|--|--------------------|
| (20) 197276 Bearing. All 1939-46 Champion without overdrive. | \$61.15 ea. | (28) 188287 Thrust washer. 1940 Commander & President, front or rear. | \$7.20 ea. | Champion..... | \$95.00 ea. |
| (21) 194272 .076 snap ring. 1939-46 Champion without overdrive. | \$6.80 ea. | (29) 188289 Thrust washer. 1940 Commander & President, front & rear. | \$8.90 ea. | (36) 192302 Bearing, rear pinion. All 1940-42 except Champion..... | \$55.00 ea. |
| (21) 188521 .086 snap ring. 1940-42 Commander & 1941-42 President without overdrive..... | \$5.40 ea. | (29) 194263 Thrust washer. 1939-40 Champion, rear only. | \$8.90 ea. | (37) 188348 .086 snap ring. 1940-42 Commander & President..... | \$5.70 ea. |
| (21) 188522 .089 snap ring. 1940-42 Commander & 1941-42 President without overdrive..... | \$6.40 ea. | (29) 194264 Thrust washer. 1939-46 Champion, front only. | \$8.90 ea. | (37) 188349 .089 snap ring. 1940-42 Commander & President..... | \$6.40 ea. |
| (21) 188523 .092 snap ring. 1940-42 Commander & 1941-42 President without overdrive..... | \$6.80 ea. | (29) 513005 Thrust washer. 1941-46 Champion, rear only. | \$8.90 ea. | (37) 188350 .092 snap ring, small. 1940-42 Commander & President. | \$6.40 ea. |
| (21) 188524 .095 snap ring. 1940-42 Commander & 1941-42 President without overdrive..... | \$6.80 ea. | (29) 519926 Thrust washer. 1941-42 Commander & President, front & rear..... | \$13.40 ea. | (37) 188351 .095 snap ring. 1940-42 Commander & President..... | \$6.40 ea. |
| (23) 188285 Counter shaft. 1940 Commander & President, all without overdrive..... | \$28.40 ea. | (31) 193058 Reverse idler gear. 1940-42 Commander & President. | \$32.40 ea. | (37) 194275 .092 snap ring. 1939-46 Champion. | \$7.90 ea. |
| (23) 188385 Counter shaft. 1940 Commander & President, all with overdrive. | \$20.00 ea. | (31) 197263 Reverse idler gear. 1939-40 Champion. | \$32.40 ea. | (37) 197665 .095 snap ring, small. 1939-46 Champion..... | \$5.80 ea. |
| (23) 197250 Counter shaft. 1939-40 Champion. | \$15.40 ea. | (31) 512997 Reverse idler gear. 1941-46 Champion. | \$43.80 ea. | (37) 197666 .099 snap ring, small. 1939-46 Champion. | \$7.20 ea. |
| (23) 513079 Counter shaft. 1941-42 Commander & President..... | \$20.00 ea. | (33) G124545 Key to case for 188384..... | \$1.90 ea. | (38) 188367 .0625 snap ring, large. 1940-42 Commander & President. | \$7.20 ea. |
| (23) 513002 Counter shaft. 1941-46 Champion. | \$23.70 ea. | (33) 188284 Shaft. 1940 Commander & President without overdrive. | \$23.80 ea. | (38) 194276 .076 snap ring, large. 1939-46 Champion. | \$6.80 ea. |
| (24) 193122 Cluster gear. 1940-42 Commander & President..... | \$175.00 ea. | (33) 188384 Shaft. 1940 Commander & President with overdrive. | \$23.80 ea. | (38) 514148 .073 snap ring, large. 1941-46 Champion..... | \$6.40 ea. |
| (24) 197324 Cluster gear. 1939-40 Champion. | \$135.00 ea. | (33) 512998 Shaft. 1941-46 Champion. | \$15.40 ea. | (38.5) 188383 Washer. 1940 Commander & President. | \$8.90 ea. |
| (24) 513004 Cluster gear. 1941-46 Champion..... | \$165.00 ea. | (33) 513081 Shaft. 1942 President & Commander..... | \$19.70 ea. | (39) 193089 Slinger. 1940-42 Commander & President. | \$9.80 ea. |
| (25) 188291 Rollers. 1940-42 Commander & President. Takes 44..... | \$1.50 ea. | (34) 513003 Lock plate. 1941-46 Champion. | \$5.40 ea. | (80) 195528 Flange. 1939-40 Champion without overdrive..... | Call |
| (25) 197248 Bushings, cluster gear. 1939-46 Champion. Takes 2..... | \$8.60 ea. | (34) 512928 Lock plate. 1942 Commander & President..... | \$6.80 ea. | (81) 179233 Nut. 1940 Commander & President without overdrive. | \$8.40 ea. |
| (26) 188282 Spacer. 1940 Commander & President..... | \$9.40 ea. | (35) 197323 Pinion. 1939-40 Champion. | \$93.20 ea. | (82) 180747 Washer. 1940 Commander & President & 1939-40 Champion. | \$3.00 ea. |
| (27) 512927 Washer. 1941-42 Commander & President..... | \$7.65 ea. | (35) 512985 Pinion. 1941-46 Champion..... | \$105.35 ea. | (83) 197251 Shoe. 1939-46 Champion..... | \$30.40 ea. |
| | | (35) 513253 Pinion. 1940-42 Commander & President..... | \$98.70 ea. | (83) 198972 Shoe. 1940-42 Commander & President. | \$25.40 ea. |
| | | (36) 188494 Bearing, rear pinion. 1939-46 | | (84) 197252 Fork. 2nd & high. 1939-46 Champion. | \$40.50 ea. |
| | | | | (84) 198973 Fork. 2nd & high. 1940-42 Commander & President..... | \$45.70 ea. |
| | | | | (85) 513260 Lever and shaft, low and reverse. 1940-42 President & Commander. . | \$23.80 ea. |
| | | | | (85A) 513400 Lever and shaft, low and reverse. 1941-46 Champion. | \$46.60 ea. |
| | | | | (86) 513259 Lever and shaft, 2nd & high. 1940-42 Commander & 1941-42 President..... | \$23.80 ea. |
| | | | | (86A) 512981 Lever and shaft, 2nd and high. 1939-46 Champion..... | \$24.00 ea. |
| | | | | (88) 199251 Poppet, inner shift lever. 1939-46 Champion..... | \$23.70 ea. |
| | | | | (91) 199282 Poppet, inner shift lever. 1940-42 Commander & President. Takes 2..... | \$9.50 ea. |
| | | | | (92) 197192 Lever, low and reverse. 1940-42 Commander & President. | \$15.60 ea. |
| | | | | (93) 197192 Lever, 2nd & high. 1940-42 Commander & President..... | \$15.60 ea. |
| | | | | (94) 197565 Insulator. 1940-46 all and (late) 1939 Champion. Takes 2..... | \$8.00 ea. |

TRANSMISSION OVERDRIVE UNIT 1939-46 SIXES & EIGHTS

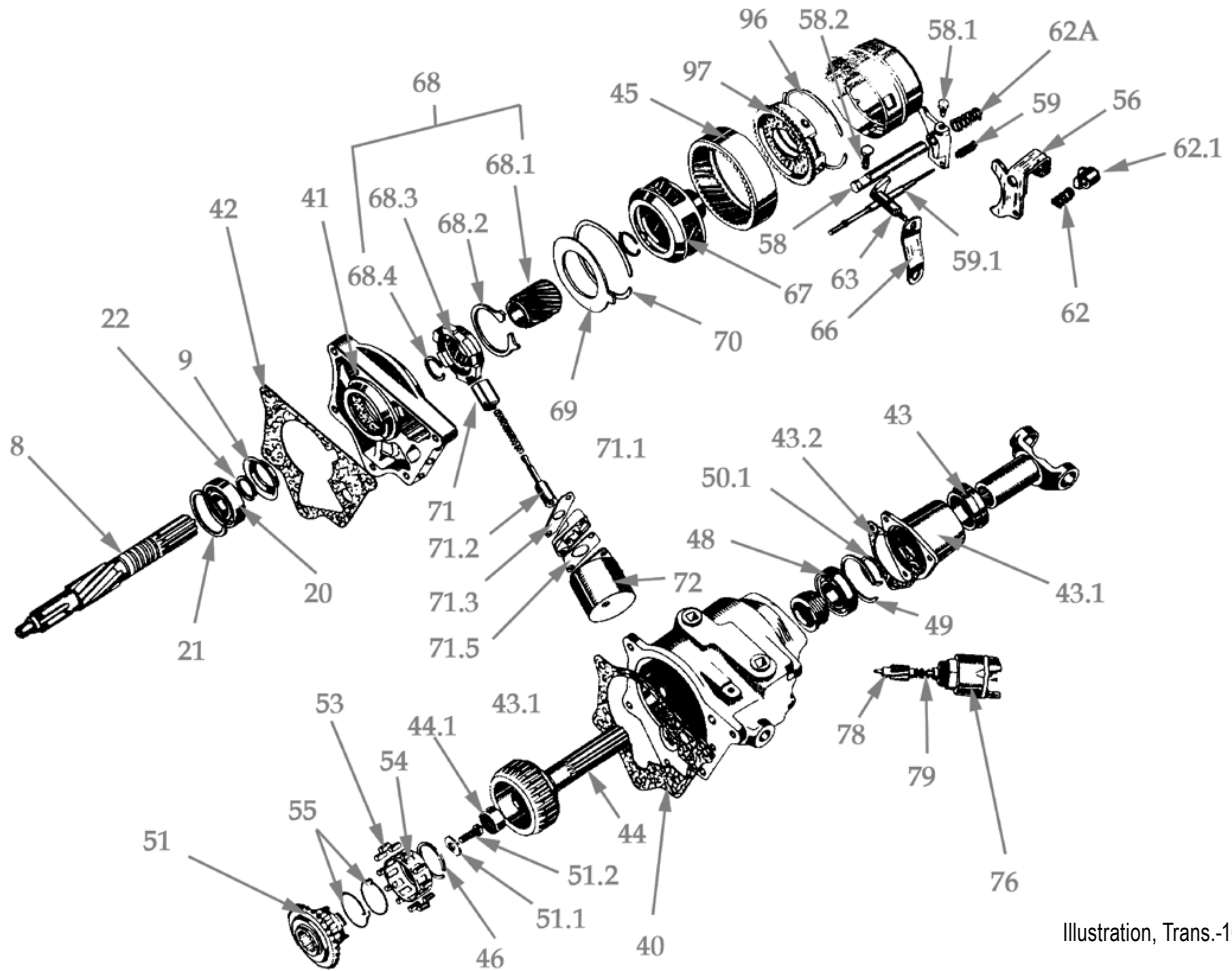

Illustration, Trans.-10

- | | | |
|---|--|--|
| (8) 197267 Main shaft. 1939-40 Champion with overdrive..... \$107.30 ea. | (21) 512992 .062 snap ring. 1941-46 Champion with overdrive \$5.40 ea. | (22) 197242 .095 snap ring. 1939-46 Champion with overdrive \$3.00 ea. |
| (8) 512988 Main shaft. 1941-46 Champion with overdrive..... \$107.30 ea. | (21) 512993 .065 snap ring. 1941-46 Champion with overdrive \$5.40 ea. | (40) 197225 Gasket. 1939-40 Champion..... \$5.40 ea. |
| (8) 513257 Main shaft. 1941-42 all except Champion cars with overdrive \$82.40 ea. | (21) 512994 .068 snap ring. 1941-46 Champion with overdrive..... \$5.40 ea. | (40) 198985 Gasket. 1940 Commander & President..... Order S-632 Gasket Set |
| (9) 197270 Baffle. 1939-46 Champion..... Call | (21) 512995 .071 snap ring. 1941-46 Champion with overdrive \$5.40 ea. | (40) 513008 Gasket. 1941-46, all..... \$1.80 ea. |
| (20) 134030 Bearing. 1940-42 all except Champion..... \$49.00 ea. | (22) 188348 .086 snap ring. 1940-42 Commander & 1941-42 President with overdrive..... \$5.70 ea. | (41) Plate..... No Stock |
| (20) 197275 Bearing. 1939-46 Champion all with overdrive \$43.70 ea. | (22) 188349 .089 snap ring. 1940-42 Commander & 1941-42 President with overdrive..... \$6.40 ea. | (42) 197223 Gasket. 1939-40 Champion..... Order S-628 Gasket Set |
| (21) 188521 .086 snap ring. 1940-42 Commander & 1941-42 President without overdrive..... \$5.40 ea. | (22) 188350 .092 snap ring. 1940-42 Commander & 1941-42 President with overdrive..... \$6.40 ea. | (42) 198987 Gasket. 1940 Commander & President..... Order S-632 Gasket Set |
| (21) 188522 .089 snap ring. 1940-42 Commander & 1941-42 President without overdrive..... \$6.40 ea. | (22) 188351 .095 snap ring. 1940-42 Commander & 1941-42 President with overdrive..... \$6.40 ea. | (43) 198779 Oil seal, overdrive housing. 1941-46 Champion & 1941-42 Commander & President..... \$20.50 ea. |
| (21) 188523 .092 snap ring. 1940-42 Commander & 1941-42 President without overdrive..... \$6.80 ea. | (22) 197239 .086 snap ring. 1939-46 Champion with overdrive. \$4.50 ea. | (43) 1541097 Oil seal, overdrive. 1939-40 Champion, 1940 Commander & President..... \$13.00 ea. |
| (21) 188524 .095 snap ring. 1940-42 Commander & 1941-42 President without overdrive..... \$6.80 ea. | (22) 197240 .089 snap ring. 1939-46 Champion with overdrive \$3.00 ea. | (43.1) 513009 .005 flange, overdrive housing. All 1941-46..... \$20.00 ea. |
| (21) 194272 .076 snap ring, large. 1939-46..... \$6.80 ea. | (22) 197241 .092 snap ring. 1939-46 Champion with overdrive \$3.00 ea. | (43.2) 516565 .005 gasket, overdrive flange. All 1941-46 \$4.00 ea. |
| | | (43.2) 516566 .010 gasket, overdrive flange. 1941-46, all..... \$4.00 ea. |
| | | (44) 513019 Shaft, overdrive. All 1941 car..... \$120.00 ea. |

- (44) **516742** Shaft, overdrive. All 1942-46 car ...
..... **\$129.00 ea.**
- (44.1) **515378** Bearing. 1939 Champion & all
1940-46..... **\$22.00 ea.**
- (45) **190893** Gear or sleeve. **\$111.40 ea.**
- (46) **190919** Snap ring. 1939 Champion & all
1940-46..... **\$5.70 ea.**
- (48) **197275** Bearing. 1939 Champion & all 1940
..... **\$43.70 ea.**
- (50) **190927** Snap ring. 1939 Champion & all
1940 car **\$2.80 ea.**
- (50) **194272** Snap ring. All 1941-46 car.....
..... **\$6.80 ea.**
- (50.1) **190926** .086 snap ring. 1939 Champion &
all 1940..... **\$2.80 ea.**
- (50.1) **190927** .089 snap ring. 1939 Champion &
all 1940..... **\$2.80 ea.**
- (50.1) **190928** .092 snap ring. 1939 Champion &
all 1940..... **\$3.90 ea.**
- (50.1) **190929** .095 snap ring. 1939 Champion &
all 1940..... **\$3.90 ea.**
- (50.1) **197239** .086 snap ring. All 1941-46.
..... **\$4.50 ea.**
- (50.1) **197240** .089 snap ring. All 1941-46.
..... **\$3.00 ea.**
- (50.1) **197241** .092 snap ring. All 1941-46.
..... **\$3.00 ea.**
- (50.1) **197242** .095 snap ring. All 1941-46.
..... **\$3.00 ea.**
- (50.1) **516554** .100 snap ring. All 1941-46.....
..... **\$3.90 ea.**
- (51) **515379** Cam. 1939 Champion & all 1940-
46. **\$98.80 ea.**
- (51.1) **193117** Washer. 1939 Champion & all
1940-46..... **\$2.80 ea.**
- (51.2) **G181364** Screw. 1939 Champion & all
1940-46..... **\$3.25 ea.**
- (53) **190917** Roller **\$22.00 set/12**
- (54) **190918** Retainer. 1939 Champion & all
1940-46..... **\$17.40 ea.**
- (55) **188541** Spring. 1939 Champion, all 1940-
46. 1941 and later takes 2 **\$6.75 ea.**
- (56) **197221** Fork. 1939-40 Champion
..... **\$36.00 ea.**
- (56) **513014** Fork. All 1941-46 **\$24.80 ea.**
- (58.1) **190912** Set screw. 1941-46, all
..... **\$5.40 ea.**
- (59) **514534** Spring. 1941-46 all except late
1942 President. **\$5.00 ea.**
- (59.1) **514532** Plunger. Early 1942 Commander
& President..... **\$17.80 ea.**
- (59.1) **514536** Plunger. 1941 Commander &
President. **\$17.80 ea.**
- (62A) **197231** Spring. 1941 Commander and
President & 1939-46 Champion. **\$5.00 ea.**
- (63) **197222** Shaft. 1939-40 Champion **Call**
- (63) **513017** Shaft. 1941-46, all. **\$18.00 ea.**
- (66) **513939** Lever. 1941-46 all **Call**
- (68) **198988** Sun gear, complete. All 1940.....
..... **\$84.50 ea.**
- (68) **513020** Sun gear, complete. 1941-46, all. ...
..... **\$93.20 ea.**
- (68.1) **513021** Sun gear. Gear only. All 1941-46
..... **\$42.50 ea.**
- (68.2) **198989** Blocking ring. Some 1940 & all
1941-46 Champion. Also fits 1940-42 Com-
mander & President..... **\$24.90 ea.**
- (68.4) **190883** Snap ring. All 1939-46.....
..... **\$3.00 ea.**
- (69) **196184** Plate. All 1939 & some 1940
Champion..... No Stock
- (69) **198990** Plate. Some 1940 Champion,
1941-46 Champion & all 1940-42 Commander
& President..... **Call**
- (71) **513023** Pawl. 1941- early 42 Commander &
President **\$28.90 ea.**
- (71) **513023** Pawl. 1941-46 Champion
..... **\$28.90 ea.**
- (71.1) **196182** Spring. 1939-46 all models
except late 1942 President. **\$5.00 ea.**
- (71.2) **196181** Rod. 1939-46 all models.....
..... **\$12.30 ea.**
- 196183** Trans rod oil seal. No illustration. 1939-
46 all..... **\$5.00 ea.**
- 196197** Step washer. No illustration. 1939-46
all..... **\$5.00 ea.**
- 667090** Plug. No illustration **\$2.00 ea.**
- (72) **196198** Solenoid. 1940 Commander &
President. **\$82.40 ea.**
- (72) **197266** Solenoid. 1939-40 Champion.
..... **\$120.00 ea.**
- (72) **513292** Solenoid. 1941-46 all models
except late 1942 President. **\$137.50 ea.**
- (79) **515708** Snap ring. 1942 President.
..... **\$7.30 ea.**
- (96) **190895** .054 snap ring, overdrive clutch.
1939-46, all **\$8.20 ea.**
- (96) **190896** .056 snap ring, overdrive clutch.
1939-46, all. **\$8.20 ea.**
- (96) **190897** .058 snap ring, overdrive clutch.
1939-46, all **\$8.20 ea.**
- (97) **516014** Clutch, complete. 1942-46, all
models..... **\$177.35 ea.**

Returning Parts?

Please include a copy of your invoice with your return.

There is a \$5.00 "Invoice Search" fee
for items returned without one.

STANDARD & OVERDRIVE TRANSMISSION *Includes Land Cruiser

YEAR SYMBOL	MODEL	YEAR SYMBOL	MODEL	YEAR SYMBOL	MODEL
1947	Champion 6G	1954	Champion 15G	1950*	Commander 17A
1948	Champion 7G	1955	Champion 16G	1951*	Commander H
1949	Champion 8G	1956	Champion 56G	1952*	Commander 3H
1950	Champion 9G	1957	Champion 57G	1953	Commander 4H
1951	Champion 10G	1947*	Commander 14A	1954	Commander 5H
1952	Champion 12G	1948*	Commander 15A	1955	V-8 16G8/6H
1953	Champion 14G	1949*	Commander 16A	1956	V-8 56B & H
				1957	V-8 57 B, H, L

T96 (6-cylinder) & T86 (V-8) STANDARD OVERDRIVE

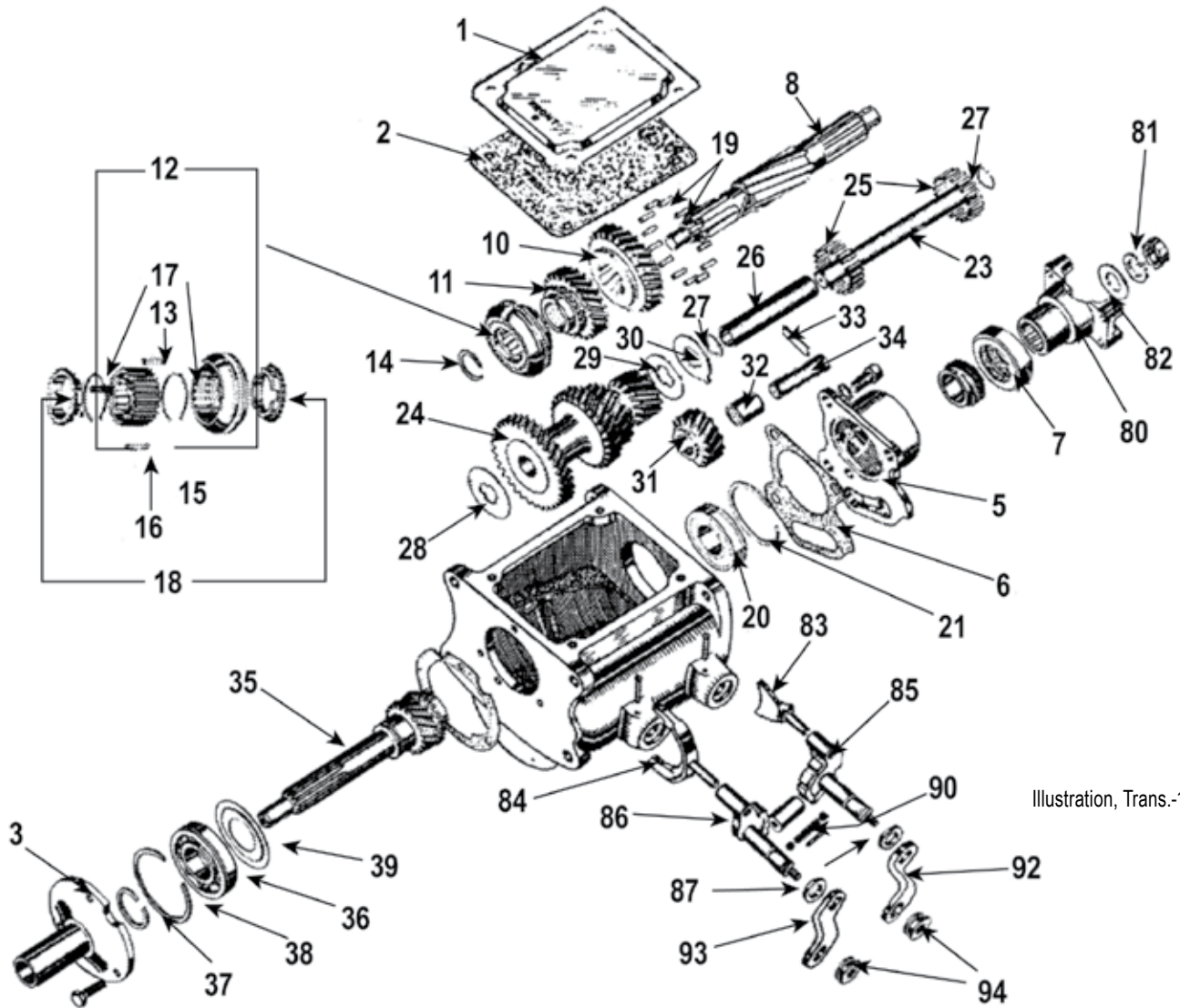

Illustration, Trans.-11

TRANSMISSION CASE

- (1) **522379** Cover. 6G-57G..... **\$28.00 ea.**
- (2) **522378** Gasket. 6G-57G..... **\$10.30 ea.**
- (2) **523183** Gasket. 14A-57B, H, L.....
..... Only available in complete gasket set
- (3) **197287** Flange. 6G-57G..... **\$45.30 ea.**
- (3) **193060** Flange. 14A-57B, H, L ... **\$70.00 ea.**
- (4) **197234** Gasket. 6G-57G..... **\$6.70 ea.**
- (4) **188296** .009 gasket. 14A-57B, H, L.....
..... **\$6.70 ea.**
- (4) **188298** .0135 gasket. 14A-57B, H, L.....
..... **\$6.70 ea.**
- (4) **192306** .025 gasket. 14A-57B, H, L. Avail-
able only in 800380 set..... **\$6.75 ea.**
- (5) **521423** Flange. 6G-157G..... **\$42.80 ea.**
- (5) **674859** Flange. 14A-57B, H, L ... **\$83.20 ea.**
- (6) **535033** Gasket. 6G-57G. Also available in
800381 gasket set..... **\$6.40 ea.**
- (6) **513075** Gasket. 14A-57B, H, L. Also avail-
able in 800380 gasket set..... **\$4.40 ea.**
- (7) **1541097** Rear seal, single lip type.....
..... **\$13.00 ea.**
- 535516** Transmission gasket set. 6G-57G.
Includes all paper gaskets..... **\$21.60 ea.**
- 800380** Transmission gasket set. 14A-57B, H,
L. Includes all paper gaskets..... **\$27.50 ea.**

MAIN SHAFT, GEAR & BEARINGS

- (8) **521473** Shaft, standard. 6G-57G.....
.....\$132.80 ea.
- (8) **521474** Shaft, with overdrive. 6G-57G.....
.....\$112.55 ea.
- (8) **521749** Shaft, standard. 14A-57B, H, L.....
.....\$132.80 ea.
- (8) **521750** Shaft, without overdrive. 14A-57B,
H, L.....\$123.40 ea.
- Note: Except 521474, the supply of shafts is very limited. 14A-57B, H, L.**
- (9) **521478** Baffle, with overdrive. 6G-57G.....
.....\$5.40 ea.
- (9) **521758** Baffle, without overdrive. 14A-57B,
H, L.....\$7.20 ea.
- (10) **521479** Gear, low & reverse. 6G-57G.....
.....\$132.80 ea.
- (10) **1540394** Gear, low & reverse. 14A-57B, H,
L.....Call
- (11) **521483** Gear, 2nd. 6G-57G.....\$73.80 ea.
- (11) **1540393** Gear, 2nd. 14A-57B, H, L.....
.....\$93.40 ea.
- (12) **521484** Synchronizer assembly. 6G-57G
without blocking rings.....\$110.75 ea.
- (12) **674868** Synchronizer assembly.
14A-57B,H,L without blocking rings.....
.....\$198.00 ea.
- (13) **521486** Gear, 2nd & high synchronizer.
6G-57G.....\$98.85 ea.
- (13) **674884** Gear, 2nd & high synchronizer.
14A-57B, H, L.....\$73.80 ea.
- (14) **1549784** Snap ring. 6G-57G.....\$7.20 ea.
- (14) **1554074** Snap ring. 14A-57B, H, L.....
.....\$6.20 ea.
- (15) **521485** Sleeve, 2nd & high synchronizer.
6G-57G.....\$65.00 ea.
- (15) **198968** Sleeve, 2nd & high synchronizer.
14A-57B, H, L.....Available only in
.....synchronizer assembly.
- (16) **521487** Plate, 2nd & high synchronizer.
6G-57G. Takes 3.....\$6.20 ea.
- (16) **198970** Plate, 2nd & high synchronizer.
14A-57B, H, L. Takes 3.....\$10.00 ea.
- (17) **199111** Snap ring. 6G-57G. Takes 2.....
.....\$5.40 ea.
- (18) **197306** Blocking ring, 2nd & high synchro-
nizer. 6G-57G. Takes 2.....\$28.00 ea.
- (19) **512990** Roller, main shaft front. 6G-57G.
Takes 13.....\$1.50 ea.
- (19) **188295** Roller, main shaft front. 14A-57B,
H, L, Takes 14.....\$3.25 ea.
- (20) **197276** Bearing, main shaft rear. Standard
6G-57G.....\$61.15 ea.
- (20) **1542951** Bearing, main shaft rear with
overdrive. 6G-57G.....\$44.50 ea.
- (20) **134030** Bearing, main shaft rear. 14A-3H..
.....\$49.00 ea.
- (21) **521745** .074 snap ring, large. 6G-57G.....
.....\$5.40 ea.
- (21) **194272** .076 snap ring, large. 2G-57G.....
.....\$6.80 ea.
- (21) **197239** .086 snap ring, small. 6G-57G.....
.....\$4.50 ea.
- (21) **197240** .089 snap ring, small. 6G-57G.....
.....\$3.00 ea.

- (21) **197241** Snap ring, small (.092). 6G-57G....
.....\$3.00 ea.
- (21) **1554074** Snap ring, small (.086-.088) 14A-
57 B, H, L.....\$6.20 ea.
- (21) **1554075** Snap ring, small (.084-.091) 14A-
57 B, H, L.....\$6.40 ea.
- (21) **1554076** Snap ring, small (.092-.094) 14A-
57 B, H, L.....\$6.40 ea.

COUNTER SHAFT & RELATED PARTS

- (23) **521488** Counter shaft. 6G-57G.....
.....\$32.80 ea.
- (23) **1553388** Counter shaft. 14A-57 B, H, L.....
.....\$100.00 ea.
- (24) **521489** Cluster gear. 6G-57G.....Call
- (24) **1540389** Cluster gear. 14A-57B, H, L Call
- (25) **188291** Roller, cluster gear. 6G-57G. Takes
40.....\$1.50 ea.
- (25) **188291** Roller, cluster gear. 14A-57 B, H,
L, Takes 44.....\$1.50 ea.
- (26) **521490** Spacer, roller bearing. 6G-57G.
Takes 1.....\$13.20 ea.
- (26) **531713** Spacer & washer kit. 14A-57 B, H,
L, Takes 1.....\$32.40 ea.
- (27) **521491** Washer. 6G-57G. Takes 2.....
.....\$5.00 ea.
- (27) **512927** Washer. Early 14A-57B, H, L.
Takes 2.....\$7.65 ea.
- (27) **512927** Washer. Late 3H. Takes 4.....
.....\$7.65 ea.
- (28) **521492** Thrust washer, 2-1/8" overdrive.
6G-57G.....\$7.65 ea.
- (28) **674873** Thrust washer, 2-5/8" overdrive.
14A-57B, H, L.....\$14.20 ea.
- (29) **674872** Thrust washer, 1-15/16" overdrive.
14A-57B, H, L.....\$13.20 ea.
- (29) **521494** Thrust washer, 1-29/32" overdrive.
6G-57G.....\$8.40 ea.
- (30) **521493** Thrust washer, 1-29/32" overdrive.
6G-57G.....\$10.50 ea.
- (30) **674874** Thrust washer, 1-29/32" overdrive.
14A-57B, H, L.....\$13.20 ea.

REVERSE IDLER GEAR & SHAFT

- (31) **521480** Gear, reverse idler. 6G-57G.....
.....\$44.20 ea.
- (31) **1540390** Gear, reverse idler. 14A-57 B, H,
L.....\$72.30 ea.
- (32) **521481** Bushing. 6G-57G.....\$9.40 ea.
- (33) **521482** Shaft. 6G-57G.....\$17.00 ea.
- (33) **521761** Shaft. 14S-57B, H, L.....\$18.20 ea.
- (34) **513003** Lock plate. 6G-57G.....\$5.40 ea.
- (34) **512928** Lock plate. 14A-57B,H,L.....
.....\$6.80 ea.

MAIN DRIVE PINION & BEARINGS

- (35) **521471** Pinion shaft. 6G-57G...\$94.00 ea.
- (35) **1540373** Pinion shaft. 14A-57B, H, L.....
.....\$147.50 ea.

- (36) **192302** Bearing. 1955 & earlier.....
.....\$55.00 ea.
- (36) **1540395** Bearing. 1956 & later.....
.....\$107.00 ea.
- (37) **522854** .087 snap ring. 6G-57G..\$5.00 ea.
- (37) **194275** .092 snap ring. 6G-57G..\$7.90 ea.
- (37) **197665** .095 snap ring. 6G-57G..\$5.80 ea.
- (37) **197666** .098 snap ring. 6G-57G..\$7.20 ea.
- (37) **532763** .103 snap ring. 6G-57G..\$6.40 ea.
- (37) **1554074** .087 snap ring. 14A-57 B, H, L...
.....\$6.20 ea.
- (37) **1554075** .090 snap ring. 14A-57 B, H, L...
.....\$6.40 ea.
- (37) **1554076** .093 snap ring. 14A-57 B, H, L...
.....\$6.40 ea.
- (37) **1554077** .101 snap ring. 14A-57 B, H, L...
.....\$6.20 ea.
- (38) **514148** .074 snap ring. 6G-57G..\$6.40 ea.
- (38) **194276** .077 snap ring. 6G-57G..\$6.80 ea.
- (38) **188367** .0625 snap ring. 14A-57 B, H, L...
.....\$7.20 ea.

U-JOINT FLANGE

- (81) **179233** Nut, on transmission shift. All.....
.....\$8.40 ea.
- (82) **180747** Washer, plain. All.....\$3.00 ea.
- (83) **521497** Shoe, low & reverse. 6G-57G.....
.....\$46.80 ea.
- (83) **674883** Shoe, low & reverse. 14A-57 B, H,
L.....\$57.30 ea.
- (84) **521496** Fork, 2nd & high. 6G-57G.....
.....\$36.20 ea.
- (84) **198973** Fork, 2nd & high. 14A-57 B, H, L.
.....\$45.70 ea.
- (85) **521469** Lever & shaft, inner, low & reverse.
6G-57G.....\$45.20 ea.
- (85) **521757** Lever & shaft, inner, low & reverse.
14A-15A.....\$42.30 ea.
- (85) **525337** Lever & shaft, inner, low & reverse.
16A-57B, H, L.....\$43.00 ea.
- (86) **521467** Lever & shaft, inner, 2nd & high.
6G-57G.....\$45.20 ea.
- (86) **674866** Lever & shaft, inner, 2nd. 14A-57
B, H, L.....\$42.80 ea.
- (86) **G103565** Pin, locating or retainer. All.....
.....\$1.50 ea.
- (87) **674869** Seal, inner. All.....\$7.00 ea.
- (88) **674890** Sleeve 1.287" long. All.....
.....\$18.80 ea.
- (88) **674889** Sleeve 1.291" long.\$15.60 ea.
- Note: We have a few of the other sleeves in 1.295"
and 1.303". All.....\$15.60 ea.**
- (89) **674885** Spring. All.....\$6.75 ea.
- (90) **527517** Plunger. All.....\$12.00 ea.
- (91) **G147487** 5/16" ball. All. Takes 2 ...50¢ ea.
- (92) **518948** Lever, low & reverse. All.....
.....\$21.10 ea.
- (93) **519425** Lever, 2nd & high. 6G-57G.....
.....\$14.75 ea.
- (93) **519621** Lever, 2nd & high. 14A-57 B, H, L.
.....\$14.75 ea.
- (94) **197565** Insulator. All. Takes 2.....\$8.00 ea.

STANDARD & OVERDRIVE 1947-57

Illustration, Trans.-12

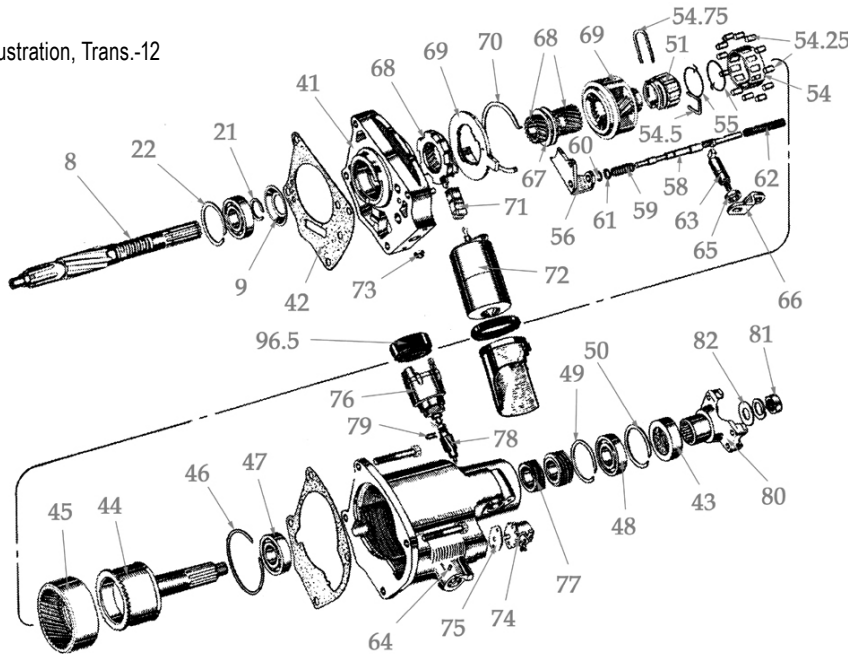

MAIN SHAFT, GEAR & BEARINGS

- (8) **521473** Shaft, standard. 6G-57G..... \$132.80 ea.
- (8) **521474** Shaft, with overdrive. 6G-57G..... \$112.55 ea.
- (8) **521749** Shaft, standard. 14A-57B, H, L..... \$132.80 ea.
- (8) **521750** Shaft, without overdrive. 14A-57B, H, L..... \$123.40 ea.
- Note: Except 521474, the supply of shafts is very limited. 14A-57B, H, L.*
- (9) **521478** Baffle, w/overdrive. 6G-57G..... \$5.40 ea.
- (9) **521758** Baffle, without overdrive. 14A-57B, H, L..... \$7.20 ea.
- (21) **1554075** .089 snap ring, small..... \$6.40 ea.
- (21) **1554076** .092 snap ring, small..... \$6.40 ea.
- (21) **1554077** .095 snap ring, small..... \$6.20 ea.
- (22) **512992** .062 snap ring, large. 6G-57G..... \$5.40 ea.
- (22) **512993** .065 snap ring, large. 6G-57G..... \$5.40 ea.
- (22) **512994** .068 snap ring, large. 6G-57G..... \$5.40 ea.
- (22) **512995** .071 snap ring, large. 6G-57G..... \$5.40 ea.
- (22) **188521** .086 snap ring, large. 14A-57B, H, L..... \$5.40 ea.
- (22) **188522** .089 snap ring, large. 14A-57B, H, L..... \$6.40 ea.
- (22) **188523** .092 snap ring, large. 14A-57B, H, L..... \$6.80 ea.
- (22) **188524** .095 snap ring, large. 14A-57B, H, L..... \$6.80 ea.
- (23) **134030** Bearing. 14A-57B, H, L..... \$49.00 ea.
- (23) **197275** Bearing. 6G-57G..... \$43.70 ea.

OVERDRIVE

- (41) **521753** Adapter plate. 14A 57B, H, L..... \$115.00 ea.
- (42) **521500** Gasket. 6G-57G..... \$3.00 ea.
- (42) **522095** Gasket. 14A-57B, H, L..... Available only in 800380 gasket set
- (43) **1541097** Rear seal..... \$13.00 ea.
- (44) **521445** Shaft, overdrive. 6G - early 7G, early 14A, 15A before serial #L108-2..... \$127.50 ea.

- (44) **525675** Shaft, overdrive. Late 7G-12G, late 15A-57B, H, L after serial # L108-2..... \$171.00 ea.
- (45) **525673** Gear. All..... \$117.50 ea.
- (46) **521448** Snap ring. All..... \$5.50 ea.
- (47) **1542951** Bearing, front overdrive shaft. 6G - early 7G, 14A - early 15A..... \$44.50 ea.
- (48) **1542951** Bearing, rear overdrive shaft. 6G-9G, 14A-17A..... \$44.50 ea.
- (48) **531584** Bearing, rear overdrive shaft. 10G-16G, H-3H. Takes 1..... \$54.80 ea.
- (48) **197275** Bearing. 1956 & later..... \$43.70 ea.
- (49) **512992** .062 snap ring. All..... \$5.40 ea.
- (50) **512992** .062 snap ring. All..... \$5.40 ea.
- (50) **512993** .065 snap ring. All..... \$5.40 ea.
- (50) **512994** .068 snap ring. All..... \$5.40 ea.
- (50) **512995** .073 snap ring. All..... \$5.40 ea.

FREE WHEEL CAM

- (51) **521441** Cam. All..... Call
- (54) **521443** Retainer, freewheel clutch. All..... \$14.00 ea.
- (54.25) **190917** Roller. All. Takes 12..... \$22.00 set/12
- (54.5) **521444** Clip, retainer. All..... \$12.00 ea.
- (54.75) **521442** Clip, retainer. All..... \$5.40 ea.
- (55) **188541** Spring, freewheel clutch. All. Takes 2..... \$6.75 ea.

OVERDRIVE SHAFT

- (56) **521501** Fork, overdrive shift. 6G-early 7G, 14A - early 15A..... \$17.00 ea.
- (56) **525341** Fork, overdrive shift. Late 7G-12G, late 15A-57B, H, L..... \$17.00 ea.
- (57) **521434** Pin, overdrive shift fork guide. All..... \$2.00 ea.
- (58) **521430** Rail, overdrive shift. 6G - early 7G..... \$27.50 ea.
- (58) **521440** Rail, overdrive shift. Late 7G-57G..... \$27.50 ea.
- (58) **521754** Rail, overdrive shift. 14A - early 15A..... \$27.50 ea.
- (58) **525339** Rail, overdrive shift. Late 15A-57B, H, L..... \$27.50 ea.
- (59) **521435** Spring, overdrive shift fork. 6G - early 7G, 14A - early 15A..... \$2.50 ea.
- (59) **525344** Spring, overdrive shift fork. Late 7G

- 12G, late 15A-57B, H, L..... \$2.50 ea.
- (60) **525342** C-washer. Late 7G-57G, late 15A-57B, H, L..... \$2.50 ea.
- (61) **521433** Cupped washer. 6G - early 7G, 14A - early 15A..... \$2.50 ea.
- (61) **525343** Cupped washer. Late 7G-57G, late 15A-57B, H, L..... \$2.50 ea.
- (62) **521431** Spring, overdrive shift, rail reverse lockup. All..... \$4.00 ea.
- (63) **521438** Shaft, overdrive shift. All..... \$17.50 ea.
- (64) **G103565** Locating pin. All..... \$1.50 ea.
- (65) **674869** Seal, overdrive shift shaft. All..... \$7.00 ea.
- (66) **521439** Lever, overdrive shift shaft. All..... \$10.00 ea.

SUN GEAR

- (68) **521450** Sun gear. All..... \$82.50 ea.
- (68.1) **521451** Collar. All..... \$27.50 ea.
- 521452** Snap ring. All Not shown..... \$3.00 ea.
- (68.5) **522172** Plate blocking ring. All..... \$114.00 ea.
- (69) **521455** Plate. Before engine # 241,065.6G..... \$33.00 ea.
- (69) **522161** Plate. After engine #241,065. 6G..... \$39.75 ea.
- (70) **521456** .0625 snap ring. All..... \$7.80 ea.
- (70) **521457** .0665 snap ring. All..... \$9.35 ea.
- (70) **521458** .0705 snap ring. All..... \$7.80 ea.
- (71) **521495** Pawl. Used on 7G thru transmission serial # F298-2 & 15A serial # F118-3..... \$33.00 ea.
- (71) **525345** Pawl. Used on cars after those in listing of 521495..... \$33.00 ea.

OVERDRIVE CUT-OUT CONTROL

- (Only currently available parts are listed in this section)
- (72) **458502** Solenoid. All 1956-57... \$265.00 ea.
 - (72) **531067** Solenoid. All 1947-55... \$260.00 ea.
 - (73) **196183** Seal, solenoid operating rod. All..... \$5.00 ea.
 - (74) **521436** Overdrive lockout switch. All..... \$63.00 ea.
 - (75) **521437** Gasket for lockout switch. All..... \$3.00 ea.
 - (76) **520454** Governor. All..... \$164.00 ex.
 - (77) **520085** Gear, 7-tooth. All..... \$27.50 ea.
 - (78) **520086** Gear, 15-tooth. All..... Call
 - (79) **515708** Snap ring. All..... \$7.30 ea.

U-JOINT FLANGE

- (81) **179233** Nut, on trans shift. All..... \$8.40 ea.
- (82) **180747** Washer, plain. All..... \$3.00 ea.

TYPICAL OVERDRIVE UNIT T86 & T96 1958-66

- (8) **521474** Main shaft. T96, 1958-61..... \$112.55 ea.
- (8) **1555478** Main shaft. T96, 1962-64..... \$95.00 ea.
- (8) **1545153** Main shaft. T86, 1958-66..... \$168.50 ea.
- (8) **1545154** Main shaft. T86, 1958-66..... \$122.80 ea.
- (9) **521478** Baffle. T96, 1958-64..... \$5.40 ea.
- (9) **521758** Baffle. T86, 1958-66..... \$7.20 ea.
- (20) **1549333** Bearing. T96, T86, 1958-66 with standard transmission..... \$72.00 ea.
- (21) **197239** .086 snap ring. T96, 1958..... \$4.50 ea.

TYPICAL OVERDRIVE UNIT T86 & T96 1958-66

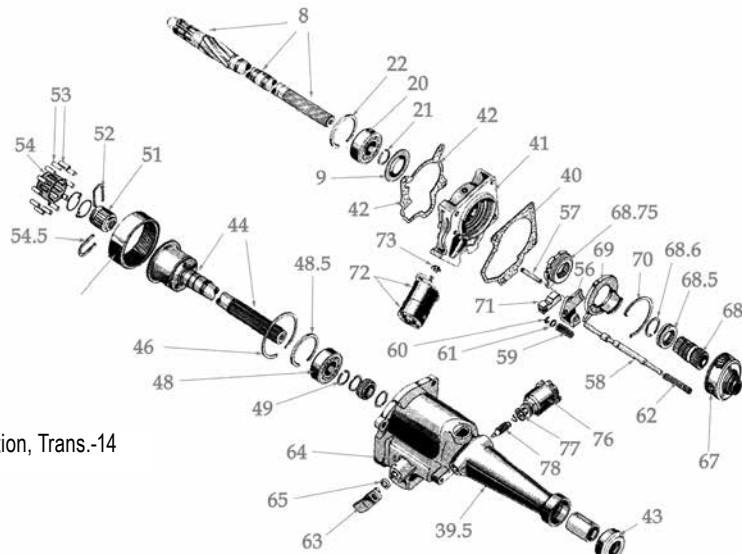

Illustration, Trans.-14

- | | | | | | |
|--|---------------------|---|---|--|-----------------------|
| (21) 197240 .089 snap ring. T96, 1958..... | \$3.00 ea. | (21) 1554074 .086 - .088 snap ring, small. T86, 1959-66..... | \$6.20 ea. | (49) 1545181 Snap ring, large. 1959-66, all without overdrive..... | \$7.70 ea. |
| (21) 197241 .092 snap ring. T96, 1958..... | \$3.00 ea. | (21) 1554075 .089 - .091 snap ring, small. T86, 1959-66..... | \$6.40 ea. | (51) 521441 Cam, overdrive. All..... | Call |
| (21) 197242 .095 snap ring. T96, 1958..... | \$3.00 ea. | (21) 1554076 .092 - .094 snap ring, small. T86, 1965-66..... | \$6.40 ea. | (52) 521444 Clip, snap ring. All..... | \$12.00 ea. |
| (21) 1550544 .086 - .088 snap ring. T96, 1959-66..... | \$2.40 ea. | (21) 1554077 .095 - .097 snap ring, small. T86, 1959-66..... | \$6.20 ea. | (53) 190917 Roller, freewheel clutch. All. Takes 12..... | \$22.00 set/12 |
| (21) 1552006 .089 - .091 snap ring. T96, 1959-66..... | \$2.40 ea. | (22) 188521 .086 - .088 snap ring, large. T86, 1965-66..... | \$5.40 ea. | (54) 521443 Retainer, freewheel clutch. All..... | \$14.00 ea. |
| (21) 1552007 .092 - .094 snap ring. T96, 1959-66..... | \$2.40 ea. | (22) 188522 .089 - .091 snap ring, large. T86..... | \$6.40 ea. | (54.5) 521442 Clip. All..... | \$5.40 ea. |
| (21) 1552008 .095 - .097 snap ring. T96, 1959-66..... | \$2.40 ea. | (22) 188523 .092 - .094 snap ring, large. T86..... | \$6.80 ea. | (55) 188541 Spring. All. Takes 2..... | \$6.75 ea. |
| (20) 134030 Bearing. T96, 1958 overdrive..... | \$49.00 ea. | (39.5) 1564802 Housing, overdrive. 1965-66, all..... | \$169.00 ea. | (56) 1542314 Fork. 1958, all..... | \$26.40 ea. |
| (21) 1554074 .086 snap ring, small. T96 or T86 1958..... | \$6.20 ea. | (40) 1545174 Gasket, overdrive housing. T96, 1958-64..... | \$3.00 ea. | (56) 1554449 Fork. 1959-66, all..... | \$22.75 ea. |
| (21) 1554075 .089 snap ring, small. T96, T86, 1958..... | \$6.40 ea. | (40) 1545166 Gasket, overdrive housing. T86, all..... | \$3.70 ea. | (57) 1545188 Pin. 1958, all. 1965-66, all.& T86, 1959-64, all..... | \$7.70 ea. |
| (21) 1554076 .092 snap ring, small. T96, T86, 1958..... | \$6.40 ea. | (41) 1545168 Plate, overdrive adapter. T96, 1958-64..... | \$118.00 ea. | (57) 521434 Pin. T96, 1959-64, all..... | \$2.00 ea. |
| (21) 1554077 .095 snap ring, small. T96, T86, 1958 overdrive..... | \$6.20 ea. | (42) 1545165 Gasket, adapter plate. T96, 1958-64..... | \$3.00 ea. | (58) 1545186 Rail. T96, 1958-64..... | \$26.40 ea. |
| (22) 188521 .086 snap ring, large. T96, T86, 1958 overdrive..... | \$5.40 ea. | (42) 1545173 Gasket, adapter plate. All..... | Only Available with 1546282 Gasket Set | (58) 1545187 Rail. T86, 1958-66..... | \$26.40 ea. |
| (22) 188522 .089 snap ring, large. T96, T86, 1958 overdrive..... | \$6.40 ea. | (43) 1553737 Rear seal, overdrive. All..... | \$10.00 ea. | (59) 525344 Spring. All..... | \$2.50 ea. |
| (22) 188523 .092 snap ring, large. T96, T86, 1958 overdrive..... | \$6.80 ea. | (44) 1545177 Shaft, overdrive. All..... | \$159.40 ea. | (60) 525342 C-washer. All..... | \$2.50 ea. |
| (22) 188524 .095 snap ring, large. T96, T86, 1958 overdrive..... | \$6.80 ea. | (45) 525673 Gear, overdrive shaft ring. All..... | \$117.50 ea. | (61) 525343 Washer. All..... | \$2.50 ea. |
| (22) 521745 .074 snap ring, large. T96, 1958 overdrive..... | \$5.40 ea. | (46) 521448 .062 snap ring. All..... | \$5.50 ea. | (62) 521431 Spring. All..... | \$4.00 ea. |
| (22) 194272 .076 snap ring, large. T96 overdrive..... | \$6.80 ea. | (48) 192302 Bearing, front overdrive shaft. 1958 only..... | \$55.00 ea. | (63) 537687 Shaft. Early 1958, all..... | \$26.40 ea. |
| (20) 1542951 Bearing. T96. 1959-64 overdrive .. | \$44.50 ea. | (48) 1540395 Bearing, front overdrive shaft. 1959-64..... | \$107.00 ea. | (63) 458496 Shaft. Late 1958-66, all..... | \$26.40 ea. |
| (21) 197239 .086 - .088 snap ring, small. T96, 1959-64 overdrive..... | \$4.50 ea. | (48.5) 371860 .087 snap ring, small. 1958, all..... | \$4.35 ea. | (64) G103565 Pin, locating. All..... | \$1.50 ea. |
| (21) 197240 .089 - .091 snap ring, small..... | \$3.00 ea. | (48.5) 371861 .090 snap ring, small. 1958, all..... | \$4.35 ea. | (65) 674869 Seal. All..... | \$7.00 ea. |
| (21) 197241 .092 - .094 snap ring, small..... | \$3.00 ea. | (48.5) 371862 .093 snap ring, small. 1958, all..... | \$4.35 ea. | (68) 521450 Gear. All..... | \$82.50 ea. |
| (22) 1543119 Snap ring, large. T96, 1959-64..... | \$7.80 ea. | (48.5) 371863 .096 snap ring, small. 1958, all..... | \$4.35 ea. | (68.5) 521451 Collar. All..... | \$27.50 ea. |
| (20) 1540395 Bearing. T86, 1959-66 with or without overdrive..... | \$107.00 ea. | (49) 1545181 Snap ring, large. 1958, all..... | \$7.70 ea. | (68.6) 521452 Snap ring. All..... | \$3.00 ea. |
| | | (48.5) 1554074 Snap ring, small. 1959-66, all without overdrive..... | \$6.20 ea. | (68.75) 522172 Plate. All..... | \$114.00 ea. |
| | | | | (69) 1545194 Plate, overdrive stationary gear. T96, all..... | \$39.60 ea. |
| | | | | (69) 1545184 Plate, overdrive stationary gear. T86, all..... | \$39.60 ea. |
| | | | | (70) 521456 .0625 snap ring. All..... | \$7.80 ea. |
| | | | | (70) 521457 .0665 snap ring. All 1958..... | \$9.35 ea. |
| | | | | (70) 521458 .705 snap ring. 1958, all..... | \$7.80 ea. |
| | | | | (71) 1545191 Pawl. T96, 1958-64..... | \$30.80 ea. |
| | | | | (71) 1545192 Pawl. T86, all..... | \$30.80 ea. |
| | | | | (72) 1545215 Solenoid. 1958-63, all..... | \$180.00 Ex. |
| | | | | (72) 1539359 Solenoid. 1964-66, all..... | \$175.00 Ex. |
| | | | | (73) 196183 Seal, solenoid. All..... | \$5.00 ea. |
| | | | | (76) 1545213 Governor. T96, 1958-63. 1958 only with rear axle # 4:55 or 4:56..... | \$154.00 ea. |
| | | | | (76) 1545214 Governor. T86, 1958 only. T96, 1958 with 3:54, 4:09 or 4:10 rear axle..... | \$115.00 ea. |
| | | | | (76) 1547572 Governor. T96, 1959 & T86, 1959-63..... | \$148.00 ea. |
| | | | | (76) 1562284 Governor. T86, 1964..... | Call |
| | | | | (76) 1562279 Governor. T96, 1964-66. T86, 1965-66..... | \$110.00 ea. |
| | | | | (78) 1544766 Gear. All 1958 car except Champion with 4:55 or 4:56 rear axle..... | \$22.30 ea. |
| | | | | (78) 1544767 Gear. T96, 1958-64 Champion with 4:55 or 4:56 rear axle..... | \$39.60 ea. |
| | | | | (78) 1547573 Gear. T96, 1959, all. T96, 1960-64 except 4:55 or 4:56 rear axle. Also fits all 1959-64 V-8 and all 1965-66..... | \$39.60 ea. |
| | | | | (79) 515708 Snap ring. All..... | \$7.30 ea. |

1958-66 T86 & T96 STANDARD & OVERDRIVE TRANSMISSION

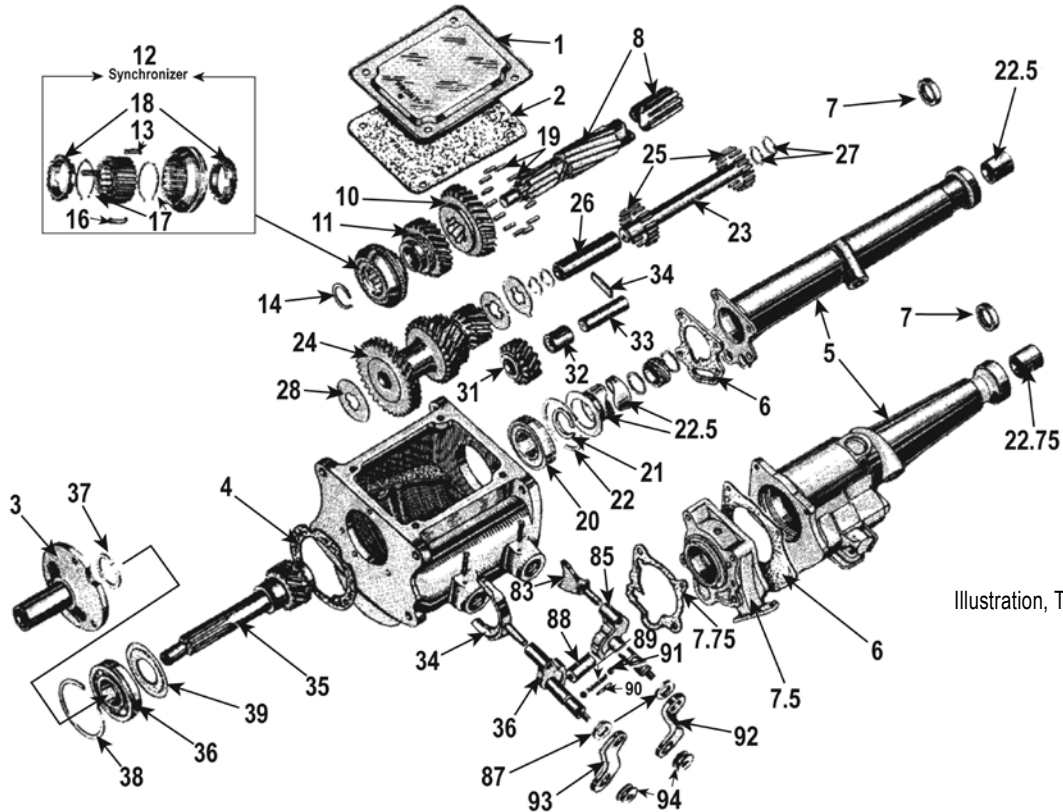

Illustration, Trans.-13

- | | | | | | |
|---|---------------------|--|--------------------------------------|---|---|
| (1) 522379 Cover. T96, 1958-64..... | \$28.00 ea. | (7) 1553737 Seal. T96 or T86 1958-66..... | \$10.00 ea. | (8) 1545154 Main shaft. T86, 1958-66 overdrive..... | \$122.80 ea. |
| (1) 1564781 Cover. T96, 1965-66.... | \$14.00 ea. | (7.5) 1545169 Plate. T86, 1958-66..... | \$121.80 ea. | (10) 521479 Gear. T96, 1958-63..... | \$132.80 ea. |
| (1) 1562889 Cover. T86, 1958-66.... | \$14.00 ea. | (7.75) 1545173 Gasket. T86, 1958-66..... | Available only in 1546282 gasket set | (10) 1562351 Gear. T96, 1964-66.... | \$93.00 ea. |
| (2) 522378 Gasket. T96, 1958-64..... | \$10.30 ea. | 1545149 Main shaft & gear set. T96, 1958-61... | \$252.30 ea. | (10) 1540394 Gear, used. T86, 1958-66.... | Call |
| (2) 1564782 Gasket. T96, 1965-66.... | \$7.80 ea. | 1555215 Main shaft & gear set. T96, 1962-64... | \$215.00 ea. | (11) 521483 Gear. T96, 1958-61..... | \$73.80 ea. |
| (2) 1545145 Gasket. T86, 1958-64.... | \$6.70 ea. | 1564783 Main shaft & gear set. T96, 1965-66... | \$215.00 ea. | (11) 1555200 Gear. T96, 1962-63.... | \$93.00 ea. |
| (2) 1562890 Gasket. T86, 1965-66.... | \$5.50 ea. | 1555217 Main shaft & gear set. T96, 1962-64
with overdrive transmission..... | \$187.50 ea. | (11) 1561959 Gear. T96, 1964..... | \$82.50 ea. |
| (3) 197287 Flange. T96, 1958-64..... | \$45.30 ea. | 1545150 Main shaft & gear set. T86, 1958-64... | \$352.80 ea. | (11) 1564785 Gear. T96, 1965-66.... | \$93.00 ea. |
| (3) 1564787 Flange. T96, 1965-66.... | \$39.20 ea. | 1564799 Main shaft & gear set. T86, 1965-66... | \$252.80 ea. | (11) 521762 Gear. T86, 1958 Champion..... | \$93.40 ea. |
| (3) 1545155 Flange. T86, 1958-64.... | \$49.90 ea. | 1545151 Main shaft & gear set. T86, 1958-66
overdrive..... | \$259.90 ea. | (11) 1540393 Gear. T86, 1958-66.... | \$93.40 ea. |
| (3) 1564787 Flange. T96, 1965-66.... | \$39.20 ea. | (8) 1545152 Main shaft. T96, 1958-61..... | \$121.30 ea. | (12) 521484 Synchronizer without blocking
rings. T96, 1958-61..... | \$110.75 ea. |
| (3) 1564797 Flange. T86, 1965-66.... | \$42.00 ea. | (8) 1555477 Main shaft. T96, 1962-64..... | \$121.30 ea. | (12) 1555461 Synchronizer without blocking
rings. T96, 1962-66..... | Call for availability & price. |
| (4) 197234 .012 gasket. T96, 1958-66..... | \$6.70 ea. | (8) 1564784 Main shaft. T96, 1965-66..... | \$148.50 ea. | (12) 674868 Synchronizer without blocking
rings. T86, 1958-66..... | \$198.00 ea. |
| (4) 188296 .009 gasket. T86, 1958 only..... | \$6.70 ea. | (8) 521474 Main shaft. T96, 1958-61 overdrive.. | \$112.55 ea. | (13) 521486 Gear. T96, 1958-61..... | \$98.85 ea. |
| (4) 188298 .0135 gasket. T86, 1958 only..... | \$6.70 ea. | (8) 1555478 Main shaft. T96, 1962-64 overdrive | \$95.00 ea. | (13) 1555462 Gear. T96, 1962-66.... | \$54.30 ea. |
| (4) 192306 .025 gasket. T96, 1958-66 Available
only in 800380-1546282 gasket set... | \$6.75 ea. | (8) 1545153 Main shaft. T86, 1958-66..... | \$168.50 ea. | (13) 674884 Gear. T86, 1958-66..... | \$73.80 ea. |
| (5) 1545156 Flange. T96, 1958-64.... | \$72.50 ea. | | | (14) 1549784 Snap ring. T96, 1958-66..... | \$7.20 ea. |
| (5) 1564792 Flange. T96, 1965-66 | \$148.00 ea. | | | (14) 1554074 Snap ring. T86, 1958-66..... | \$6.20 ea. |
| (5) 1545158 Flange. T86, 1958-59... | \$72.30 ea. | | | (15) 521485 Sleeve. T96, 1958-66... .. | \$65.00 ea. |
| (5) 1550027 Flange. T86, 1960-64.... | \$72.30 ea. | | | (15) 198968 Sleeve. T86..... | Available only in synchronizer assembly |
| (5) 1564803 Flange. T86, 1965-66..... | \$142.50 ea. | | | | |
| (6) 535033 Gasket. T96, 1958-64..... | \$6.40 ea. | | | | |
| (6) 1564791 Gasket. T96, 1965-66.... | \$5.70 ea. | | | | |
| (6) 1545166 Gasket. T86, 1958-66.... | \$3.70 ea. | | | | |

- (16) **521487** Plate, synchronizer. T96, 1958-66. Takes 3..... **\$6.20 ea.**
- (16) **198970** Plate, synchronizer. T86, 1958-66. Takes 3..... **\$10.00 ea.**
- (17) **199111** Snap ring. T96, 1958-66. Takes 2... .. **\$5.40 ea.**
- (18) **197306** Blocking ring. T96, 1958-66. Takes 2..... **\$28.00 ea.**
- (19) **512990** Roller. T96, 1958-61. Takes 13. **\$1.50 ea.**
- (19) **1555464** Roller. T96, 1962-66. Takes 13..... **\$1.60 ea.**
- (19) **188295** Roller. T86, 1958-66. Takes 14..... **\$3.25 ea.**
- (20) **1549333** Bearing. T96 or T86 1958-66 standard transmission. **\$72.00 ea.**
- (21) **197239** .086 snap ring. T96, 1958. **\$4.50 ea.**
- (21) **197240** .089 snap ring. T96, 1958. **\$3.00 ea.**
- (21) **197241** .092 snap ring. T96, 1958. **\$3.00 ea.**
- (21) **197242** .095 snap ring. T96, 1958. **\$3.00 ea.**
- (21) **1550544** .086 - .088 snap ring. T96, 1959-66..... **\$2.40 ea.**
- (21) **1552006** Snap ring. (.089-.091) T96, 1959-66..... **\$2.40 ea.**
- (21) **1552007** .092-.094 snap ring. T96, 1959-66..... **\$2.40 ea.**
- (21) **1552008** .095-.097 snap ring. T96, 1959-66..... **\$2.40 ea.**
- (20) **134030** Bearing, overdrive. T96, 1958. **\$49.00 ea.**
- (21) **1554074** .086 snap ring, small. T96, T86 1958..... **\$6.20 ea.**
- (21) **1554075** .089 snap ring, small. T96, T86 1958..... **\$6.40 ea.**
- (21) **1554076** .092 snap ring, small. T96, T86 1958..... **\$6.40 ea.**
- (21) **1554077** .095 snap ring, small. T96, T86 1958 overdrive..... **\$6.20 ea.**
- (22) **188521** .086 snap ring, large. T96, T86 1958 overdrive..... **\$5.40 ea.**
- (22) **188522** .089 snap ring, large. T96, T86 1958 overdrive..... **\$6.40 ea.**
- (22) **188523** .092 snap ring, large. T96, T86 1958 overdrive..... **\$6.80 ea.**
- (22) **188524** .095 snap ring, large. T96 or T86 1958 overdrive..... **\$6.80 ea.**
- (22) **521745** .074 snap ring, large. T96 1958 overdrive..... **\$5.40 ea.**
- (22) **194272** .076 snap ring, large. T96 overdrive..... **\$6.80 ea.**
- (20) **1542951** Bearing. T96. 1959-64 overdrive **\$44.50 ea.**
- (21) **197239** .086 - .088 snap ring, small. T96 1959-64 overdrive. **\$4.50 ea.**
- (21) **197240** .089 - .091 snap ring, small..... **\$3.00 ea.**
- (21) **197241** .092 - .094 snap ring, small..... **\$3.00 ea.**
- (22) **1543119** Snap ring, large. T96 1959-64. **\$7.80 ea.**
- (20) **1540395** Bearing. T86 1959-66 with or without overdrive **\$107.00 ea.**
- (21) **1554074** .086 - .088 snap ring, small. T86, 1959-66..... **\$6.20 ea.**
- (21) **1554075** .089 - .091 snap ring, small. T86 1959-66..... **\$6.40 ea.**
- (21) **1554076** .092 - .094 snap ring, small. T86 1965-66..... **\$6.40 ea.**
- (21) **1554077** .095 - .097 snap ring, small. T86 1959-66..... **\$6.20 ea.**
- (22) **188521** .086 - .088 snap ring, large. T86 1965-66..... **\$5.40 ea.**
- (22) **188522** .089 - .091 snap ring, large. T86..... **\$6.40 ea.**
- (22) **188523** .092 - .094 snap ring, large. T86 **\$6.80 ea.**
- (22.5) **1554137** Retainer. T86, 1965-66..... **\$22.55 ea.**
- (22.75) **1559902** Bushing. All without overdrive **\$45.00 ea.**
- (23) **521488** Counter shaft. T96, 1958-66. **\$32.80 ea.**
- (23) **1553388** Counter shaft. T86 1958-66. **\$100.00 ea.**
- (24) **521489** Cluster gear. T96, 1958-63..... **Call**
- (24) **1561961** Cluster gear. T96, 1964..... **\$149.50 ea.**
- (24) **1540389** Cluster gear. T86, 1958-66... **Call**
- (25) **188291** Roller. All. T96, takes 40. T86, takes 44..... **\$1.50 ea.**
- (26) **521490** Spacer. T96, 1958-61... **\$13.20 ea.**
- (26) **1555463** Spacer. T96, 1962-66... **\$7.70 ea.**
- (26) **531713** Spacer. T86, all..... **\$32.40 ea.**
- (27) **521491** Washer. T96, all..... **\$5.00 ea.**
- (27) **512927** Washer. T86, all..... **\$7.65 ea.**
- (28) **521492** Thrust washer. T96, all... **\$7.65 ea.**
- (31) **521480** Gear. T96, 1958-63..... **\$44.20 ea.**
- (31) **1562350** Gear. T96, 1964-66... **\$54.00 ea.**
- (31) **1540390** Gear. T86, all..... **\$72.30 ea.**
- (32) **521481** Bushing. T96, all..... **\$9.40 ea.**
- (33) **521482** Shaft. T96, all..... **\$17.00 ea.**
- (33) **521761** Shaft. T86, all..... **\$18.20 ea.**
- (34) **513003** Lock plate. T96, all..... **\$5.40 ea.**
- (34) **512928** Lock plate. T86, all..... **\$6.80 ea.**
- (35) **521471** Pinion. T96, 1958-61... **\$94.00 ea.**
- (35) **1555133** Pinion. T96, 1962-63..... **Call for availability and price**
- (35) **1561960** Pinion. T96, 1964..... **\$154.00 ea.**
- (35) **1540383** Pinion. T86, 1958-64..... **\$132.50 ea.**
- (36) **1540395** Bearing. All..... **\$107.00 ea.**
- (37) **522854** .087 snap ring, small. T96 1958..... **\$5.00 ea.**
- (37) **194275** .092 snap ring, small. T96 1958-64..... **\$7.90 ea.**
- (37) **197665** .095 snap ring, small. T86 1958-64..... **\$5.80 ea.**
- (37) **197666** .098 snap ring, small. T96 1958-64..... **\$7.20 ea.**
- (37) **532763** .103 snap ring, small. T96 1958..... **\$6.40 ea.**
- (37) **1554074** .087 snap ring, small. T96 1958 & 1965-66 T86 & T96..... **\$6.20 ea.**
- (37) **1554075** .090 snap ring, small. T86, all. T96 1965-66. **\$6.40 ea.**
- (37) **1554076** .093 snap ring, small. T86, all. T96 1965-66..... **\$6.40 ea.**
- (37) **1554077** .096 snap ring, small. T86, all..... **\$6.20 ea.**
- (37) **532764** .010 snap ring, small. T86 1958..... **\$6.20 ea.**
- (38) **514148** .074 snap ring, large. T96, all..... **\$6.40 ea.**
- (38) **194276** .077 snap ring, large. T96 1958..... **\$6.80 ea.**
- (38) **188367** .0625 snap ring, large. T86, all. **\$7.20 ea.**
- (85) **521469** Lever & shaft. T96, all with standard transmission..... **\$45.20 ea.**
- (85) **1547057** Lever & shaft. T96, 1958-64 with overdrive..... **\$39.60 ea.**
- (85) **1545147** Lever & shaft. T86 1958-64, all... .. **\$49.00 ea.**
- (85) **1564801** Lever & shaft. T86, 1965-66, all... .. **\$39.00 ea.**
- (87) **674869** Seal. All. Takes 2..... **\$7.00 ea.**
- (88) **674890** 1.287 sleeve. All..... **\$18.80 ea.**
- (88) **674889** 1.291 sleeve. All..... **\$15.60 ea.**
- (88) **674888** 1.295 sleeve. All..... **\$15.60 ea.**
- (88) **674887** 1.299 sleeve. All..... **\$15.60 ea.**
- (88) **521498** 1.303 sleeve. All..... **\$15.60 ea.**
- (89) **674885** Spring. All..... **\$6.75 ea.**
- (90) **527517** Plunger. All..... **\$12.00 ea.**
- (91) **G145641** Ball. All..... **\$6.25 set/25**
- (92) **1544247** Lever. T96, 1958 with standard transmission..... **\$13.80 ea.**
- (92) **1546796** Lever. T96, 1958 with overdrive. ... **\$13.80 ea.**
- (92) **518948** Lever. T86 1958..... **\$21.10 ea.**
- (92) **1547598** Lever. T96 1958 type without shift lever grommet. **\$13.80 ea.**
- (92) **1549303** Lever. T96 1959-64 type with shift lever grommet. **\$13.80 ea.**
- (92) **1547537** Lever. T86 1959-64.... **\$13.80 ea.**
- (93) **1544248** Lever. T96 1958 - early 1959 type without grommet..... **\$13.80 ea.**
- (93) **519425** Lever. T96 1959-64 type with shift lever grommet. **\$14.75 ea.**
- (93) **519621** Lever. T86 1958-64. **\$14.75 ea.**
- (94) **197565** Grommet or insulator. Late 1959-66, all. Takes 2..... **\$8.00 ea.**

AUTOMATIC TRANSMISSION - DG-3 BAND

The chart below will help you identify the type of automatic transmission in your Studebaker. The transmission model identification plate is located on the left side of the transmission case. To avoid possibility of error, refer to same before ordering parts.

MODEL	YEAR	US SERIAL #	CANADA SERIAL #
DG-150	1954 Champion	ALL	ALL
DG-150	1955 Champion	Before 1,147,699	Before G-758,631
DG-150M	1955 Champion	On or after 1,147,699	On or after G-760,919
DG-200	1950-53 cars	ALL	ALL
DG-200	1954 Commander	ALL	ALL
DG-200	1955 Commander with 224 cu in V8's	Before V-318,899	Before 8,957,735
DG-200M	1955 Commander With 224 cubic inch	On or after V-318,899	
DG-200M	1955 Champion	ALL	G-758,631 to G760,919
DG-250M	1955 259 V8	ALL	ALL

(I-65) EXTENSION CASE COMPLETE EXCEPT 12, 13, 14, 17

529979 1951-51 Champion \$299.00 ea.	(16) 529835 Pawl. 1950-54 Commander..... \$5.40 ea.	(36) 529971 Link assembly. 1950 Commander, 1954 Commander with part throttle, kick down, 1954 Champion \$30.70 ea.
531046 1950 Commander \$329.50 ea.	(17) 527956 Gasket. 1950-56, all models..... \$8.00 ea.	(36) 535613 Link assembly. 1955-56 with DG 150, 150M, 200M, 250M \$30.70 ea.
535626 1954-55 Champion DG 150..... \$329.50 ea.	(18) 529858 Spacer. 1950-56, all models..... \$7.15 ea.	(37) 529804 Cam. 1950-53 Champion, 1953-54 Commander with part throttle, kick down. Also 1955 Commander with DG 200 transmission..... \$13.75 ea.
529984 1951-54 Commander & 1955 Champion. DG 200..... \$329.50 ea.	(20) 529855 Gear. 1950-56, all models..... \$27.50 ea.	(38) 529849 Snap Ring. 1950-56, all models..... \$1.20 ea.
537030 1955-56 Champion & 1955 President DG 150M & 200M..... \$329.50 ea.	(21) 529857 Gear. 1950-56, all models..... \$46.20 ea.	(39) 529848 Shaft. 1950-56 all models..... \$13.75 ea.
529789 Rear oil pump complete, all models. Includes parts #1 - 9 minus #2 \$83.50 ea.	(22) 529856 Spacer. 1950-56, all models..... \$7.15 ea.	(40) 529850 Seal. Some 1950-54 car. See chassis parts book for reference. \$4.40 ea.
(2) 527966 .002 gasket. 1950-51 all models..... \$7.50 ea.	(23) Not sold separately	(41) 529832 Detent. 1950-56 all models..... \$4.95 ea.
(2) 527967 .003 gasket. 1950-51 all models..... \$7.50 ea.	(24) 529836 Plate. 1950-53 Champion, 1950-54 Commander, 1955 with DG 200. \$2.75 ea.	(42) 529833 Spring. 1950-56, all models..... \$1.20 ea.
(2) 527968 .005 gasket. 1950-51 all models..... \$5.50 ea.	(24) 535579 Plate. 1954 Champion, all 1955-56 with DG 150, 150M, 200M & 250M..... \$2.75 ea.	(43) 529527 Seal. 1950-56, all models..... \$1.35 ea.
(2) 531409X1 .006 gasket. 1950-56 all models..... \$2.75 ea.	(25) 529834 Arm. 1950-54 Commander, 1954 Champion, 1955-56 with DG 150, 150M, 200M, 250M..... \$7.15 ea.	(44) 529902 Bushing. 1950-56, all models..... \$5.50 ea.
(2) 531409X2 .009 gasket. 1950-56, all models..... \$2.75 ea.	(26) 529837 Spacer. 1950-54 Commander, 1953 Champion, 1955-56 with DG 150, 150M, 200M, 250M..... \$2.75 ea.	(45) 531040 6-tooth gear. 1950-54 all except 1951-54 Champion with 4:56 rear end and some other 1955 thru 1956 car. See speedometer gear chart in chassis parts book \$51.45 ea.
(7) 527965 Gasket. 1950-56, all models..... \$2.00 ea.	(27) 529838 Washer. 1950-54 Commander, 1954 Champion, 1955-56, all \$1.20 ea.	(46) 527963 Gasket. 1950-56, all models..... \$1.40 ea.
(8) Not sold separately	(28) 529839 Spring. 1950-54 Commander, 1954 Champion, 1955-56 all with DG 150, 150M, 200M, 250M..... \$1.20 ea.	(47) 529831 Cover. 1950-56, all models..... \$4.95 ea.
(9) Not sold separately	(29) 529815 Detent. 1950-56, all models..... \$2.75 ea.	(48) 529830 Housing . 1950-56, all models..... \$5.90 ea.
(10) 529776 Case only. 1950-56, all models..... \$177.60 ea.	(30) 529813 Valve & fork. 1950-56, all models... \$29.00 ea.	(49) 527962 Gasket . 1950-56, all models..... \$3.30 ea.
(11) 529678 Seal. Some 1950-54 cars. See chassis parts book \$5.40 ea.	(31) 529828 Governor. 1950-56, all models..... \$94.00 ea.	(50) G116102 Call
(12) 529860 Dowel screw. Late 1950 & all 1951-56 car..... \$2.50 ea.	(34 & #57) 529810 Shoe. 1950-56, all models. Takes 4..... \$7.15 ea.	(51) G138631 Screw. 1950-56, all models..... \$2.75 ea.
(12.5) 529854 Spring. 1950-56, all models..... \$1.60 ea.	(35) 529803 Yoke. 1950-56, all models..... \$21.90 ea.	(52) 529867 Nut . 1950-56, all models..... \$2.75 ea.
(13) 529851 Piston. 1950-54 car..... \$7.15 ea.		
(14) 529844 Pin. 1950-56, all models..... \$10.40 ea.		
(15) 529866 Seal. 1950 all, 1954-56 Champion, 1951-55 Commander. Takes 2..... \$1.60 ea.		

DG AUTOMATIC TRANSMISSION

Extension Case Governor, Rear Oil Pump, Speedo, Gear Housing & Parking Brake Toggle

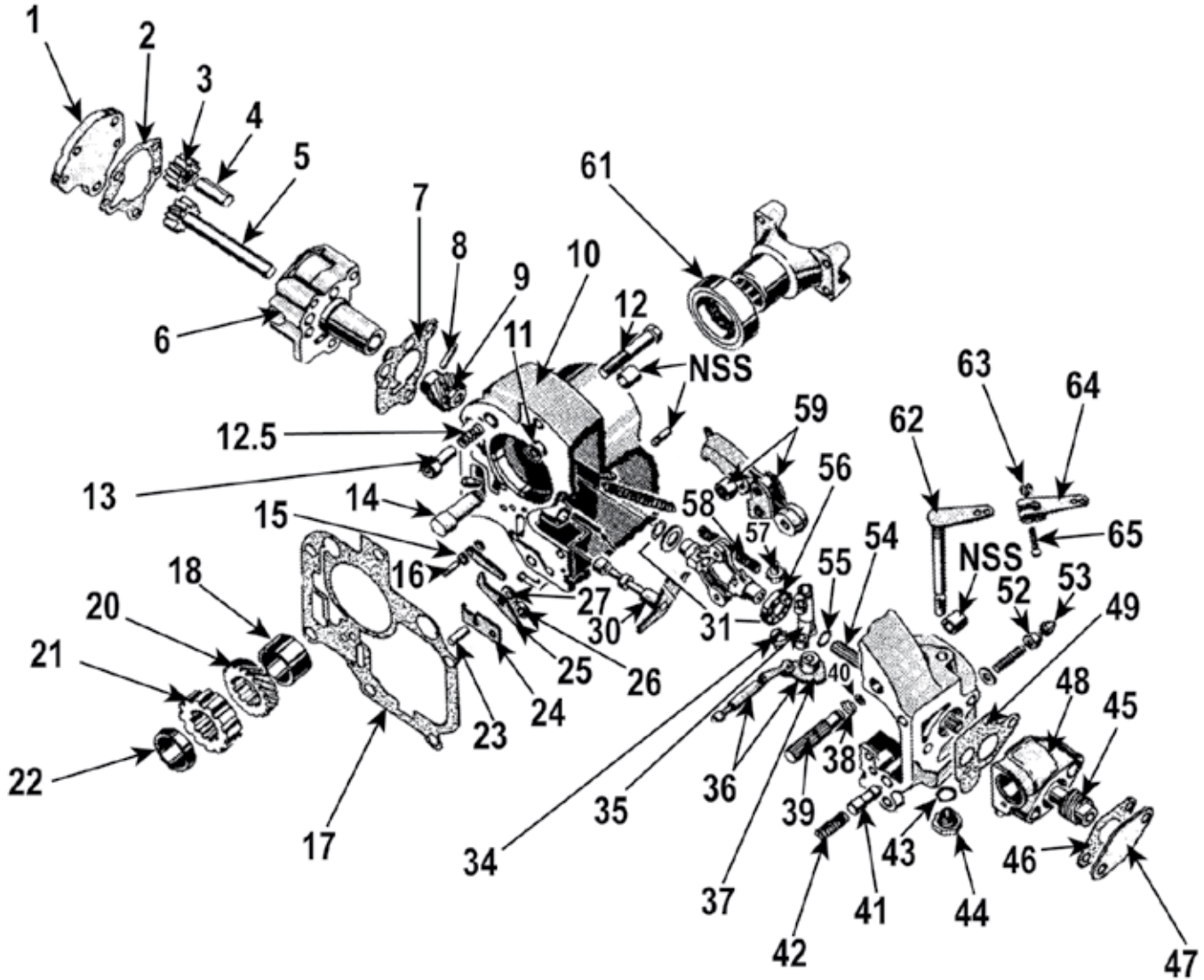

- (53) **G441261** Nut. 1950-56, all models **85¢ ea.**
- (54) **531039** Shaft. 1950-56, all models..... **\$21.90 ea.**
- (55) **529826** Snap ring. 1950-56, all models..... **\$1.20 ea.**
- (56) **529819** Bearing. 1950-56, all models..... **\$27.50 ea.**
- (57 & 34) **529810** Shoe. 1950-56, all models. Takes 2..... **\$7.15 ea.**
- (58) **529969** Spring. 1950-53 Champion..... **\$4.95 ea.**
- (58) **529827** Spring. 1950 Commander..... **\$4.95 ea.**
- (58) **529980** Spring. 1954 Champion, 1951-54 Commander & 1955 with DG200 transmission. **\$4.95 ea.**
- (58) **537066** Spring. 1955-56 with DG150, 150M, 200M & 250M..... **\$4.95 ea.**
- (59) **529840** Pawl..... Available only as part of extension case assembly
- (60) **529812** Spring. 1950-56, all models..... **\$5.90 ea.**
- (61) **1541097** Seal. Single lip replacement type. 1950-56, all models..... **\$13.00 ea.**
- (62) **531392** Shaft & lever. Late 1950 & late 1951 car, 1952-56, all models..... **\$13.20 ea.**
- (63) **529079** Nut. Early 1950 & early 1951 car. **\$1.20 ea.**
- (64) **531415** Lever. Early 1950 & early 1951 car **\$11.00 ea.**
- (65) **G132848** Bolt. Early 1950 & early 1951 car **60¢ ea.**

529828

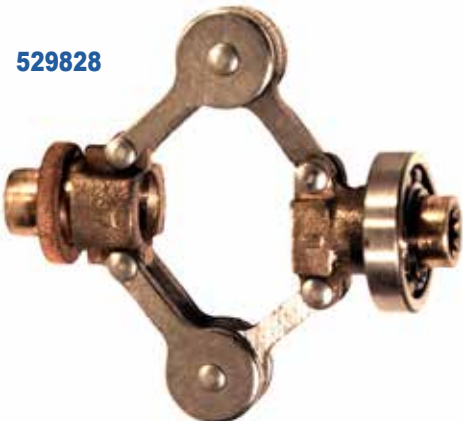

DG AUTOMATIC TRANSMISSION FRONT PUMP, MAINSHAFT & U-JOINT FLANGE

Illustration, Trans.-16

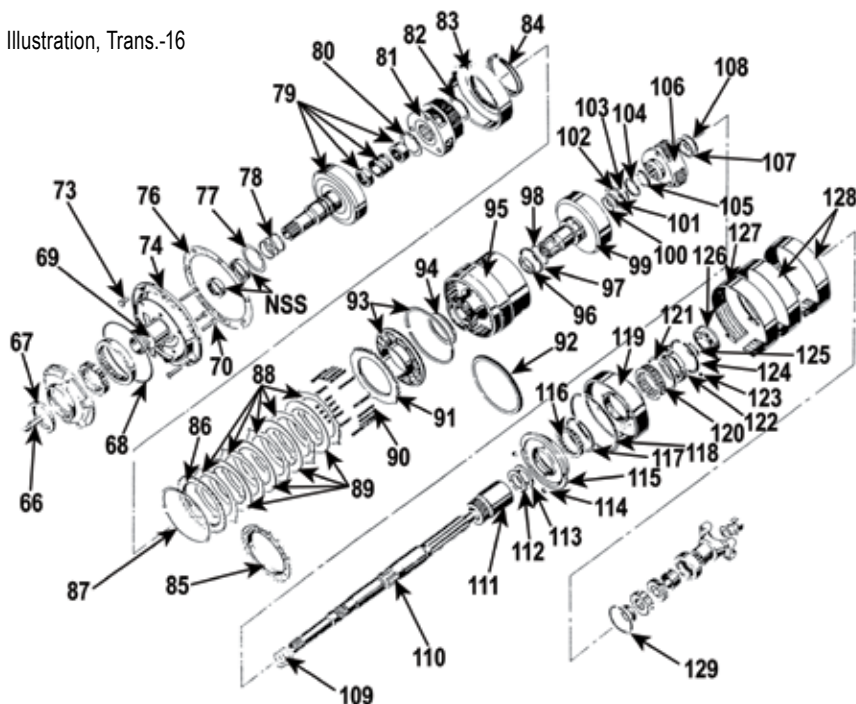

- | | |
|--|---|
| <p>(66) 529375 Tube. 1950-56, all models. \$12.50 ea.</p> <p>(67) 529582 Seal. 1950-56, all models. \$16.30 ea.</p> <p>(68) 529585 Seal. 1950-56, all models. \$12.50 ea.</p> <p>(69) 529527 Seal. 1950-56, all models. \$1.35 ea.</p> <p>(71) G179817 Screw. 1950-56, all models. Takes 2 \$3.85 ea.</p> <p>(72) 529869 Screw. 1950-56, all models. Takes 2 \$2.75 ea.</p> <p>(73) G179816 Screw. 1950-56, all models. Takes 4 \$2.75 ea.</p> <p>(74) 529899 Collector ring with bearings. 1950-56, all models & 1955 with DG 200 transmission \$170.50 ea.</p> <p>(74) 535959 Collector ring with bearings. 1955 with DG150M, 200M, 250M \$178.25 ea.</p> <p>(75) 529898 Screw. 1950-60, all models. \$3.05 ea.</p> <p>(76) 527955 Gasket. 1950-56, all models. \$8.50 ea.</p> <p>(77) 529859X1 Thrust washer .53. 1950-56 all models. \$7.15 ea.</p> <p>(77) 529859X2 .62 thrust washer. 1950-56, all models. \$7.15 ea.</p> <p>(77) 529859X3 .73 thrust washer. 1950-56, all models. \$8.55 ea.</p> <p>(77) 529859X4 .83 thrust washer. 1950-56, all models. \$8.55 ea.</p> <p>(78) 529600 Seal. 1950-56, all models. Takes 3.. \$16.50 ea.</p> <p>(79) 529623 Ring gear with bearings. 1950-54, all models & 1955 with DG150 or 200 transmission \$208.55 ea.</p> <p>(80) 529622 Thrust washer. 1950-56, all models. \$12.50 ea.</p> | <p>(81) 533905 Carrier. 1950-53 Champion, 1950-54 Commander. \$173.80 ea.</p> <p>(81) 535637 Carrier. 1954 Champion & 1955 with DG150 or 200 transmission \$208.55 ea.</p> <p>(82) 529634 Thrust washer. 1950-53 Champion, 1950-54 Commander \$8.55 ea.</p> <p>(82) 535627 Thrust washer. 1954 Champion, 1955-56, all models. \$8.55 ea.</p> <p>(83) 529647 Drum. 1950-53 Champion, 1950-54 Commander & 1955 Commander with DG200 transmission \$53.35 ea.</p> <p>(83) 535207 Drum. 1954 Champion & 1955-56 car with DG150M, 200M & 250 transmission \$64.00 ea.</p> <p>(84) 529648 Snap ring. 1950-55, all models. \$4.95 ea.</p> <p>(85) 529910 Retainer. 1950-54 Champion & 1955-56 Champion with DG150 transmission \$33.00 ea.</p> <p>(86) 529641 Retainer. 1950-54 Commander & 1955 with DG150M, DG200M & 250M transmission \$23.10 ea.</p> <p>(87) 529642 Snap ring. 1950-56, all models. \$5.90 ea.</p> <p>(88) 537699 Steel plate. 1950-56, all models. 6-cylinder, take 4. V-8 take 5. \$11.00 ea.</p> <p>(89) 537702 Disc. 1950-56, all models. 6-cylinder, take 3; V-8, take 4. \$21.90 ea.</p> <p>(90) 529640 Spring. 1950-56, all models. Takes 12 \$3.00 ea.</p> <p>(91) 529637 Plate. 1950-56, all models. \$23.10 ea.</p> <p>(92) 529645 Seal. 1950-55 Champion, 1950-51 Commander. \$12.50 ea.</p> <p>(92A) 529977 Steel seal. 1950-56, all models. \$8.25 ea.</p> <p>(93) 531356 Piston & seal. 1950-56, all models. . \$71.50 ea.</p> |
| | <p>(94) 529646 Seal. 1950-56, all models. \$12.00 ea.</p> <p>(95) 529629 Sun gear & drum. 1950-53 Champion, 1950-55 Commander with DG200 transmission \$231.00 ea.</p> <p>(95) 535576 Sun gear & drum. 1954-55 Champion with DG150 transmission. \$231.00 ea.</p> <p>(95) 537396 Sun gear & drum. 1955 car with DG150M & 200M transmission \$192.50 ea.</p> <p>(95) 537040 Sun gear & drum. 1955 V-8 with DG250M transmission \$195.75 ea.</p> <p>(96) 529628 Snap ring. 1950-56, all models. \$2.75 ea.</p> <p>(97) 529972 Steel seal. 1950-56 all models \$7.70 ea.</p> <p>(98) 529606 Seal. 1950-56, all models. \$19.80 ea.</p> <p>(99) 529602 Ring gear. 1950-53 Champion & 1950-54 Commander. \$173.80 ea.</p> <p>(99) 535602 Ring gear. 1954-55 Champion with DG150 or 200 transmission. \$178.25 ea.</p> <p>(99) 537045 Ring gear. 1955-56 with DG-150M, 200M and 250 transmission. \$173.80 ea.</p> <p>(100) 529604 Seal. 1950-56, all models. \$7.15 ea.</p> <p>(101) 529605 Retainer. 1950-56, all models. \$2.20 ea.</p> <p>(102) 529601 Thrust washer. 1950-56, all models \$12.50 ea.</p> <p>(103) 529615 Snap ring. 1950-56, all models \$1.20 ea.</p> <p>(104) 529600 Seal. 1950-56, all models. \$16.50 ea.</p> <p>(105) 529614 Retainer. 1950-56, all models \$23.10 ea.</p> <p>(106) 531400 Carrier. 1950-53 Champion & 1950-55 Commander with DG-200 transmission \$148.00 ea.</p> <p>(106) 535439 Carrier. 1954-55 Champion with DG150 transmission \$151.25 ea.</p> <p>(106) 537043 Carrier. 1955 with DG-150M, DG200M & DG250M transmission .. \$177.60 ea.</p> <p>(107) 531402 Washer. 1950-56 with counter bored carrier. \$2.60 ea.</p> <p>(108) 529612 Thrust washer. 1950-56, all models \$8.25 ea.</p> <p>(109) 529555 Seal. 1950-56, all models. Takes 3. \$9.75 ea.</p> <p>(110) 529587 Main shaft. 1950-54, all models & 1955 with DG150 or 200 transmission. \$165.00 ea.</p> <p>(110) 537033 Main shaft. 1955-56 with DG-150M, 200M & 250M transmission. \$165.00 ea.</p> <p>(111) 535577 Sun gear. 1954-55 Champion with DG150 or 200 transmission. \$93.50 ea.</p> |

- (111) **537047** Sun gear. 1955-56 with DG-150M, 200M or 250M transmission..... **\$112.20 ea.**
- (112) **529661** Thrust washer. 1950-56, all models **\$9.90 ea.**
- (113) **529660** Washer. 1950-56, all models **\$12.50 ea.**
- (114) **535580** Dowel. 1954 Champion & 1955-56 with DG150M, 200M & DG150 transmission **\$4.95 ea.**
- (115) **531036** Plate. 1950-53 Champion & 1950-55 Commander with DG 200 transmission **\$94.00 ea.**
- (115) **535214** Plate. 1954 Champion & 1955 w/ DG150 & 200M transmission..... **\$93.50 ea.**
- (115) **537253** Plate. 1955-56 with DG150M & 250M transmission. **\$112.50 ea.**
- (116) **1551173** Free wheel. 1954-56 Champion w/DG150 or DG200M transmission... **\$83.50 ea.**
- (116) **537050** Free wheel. 1955 with 250M transmission. **\$83.50 ea.**
- (117) **529650** Snap ring. 1950-54, all models & 1955 Commander with DG200 transmission **\$4.95 ea.**
- (118) **529642** Snap ring. 1950-56, all models **\$5.90 ea.**
- (119) **529664** Drum. 1950-53 Champion, 1950-55 Commander with DG200 transmission **\$112.50 ea.**
- (119) **535212** Drum. 1955-56 with DG150, 150M, 200M & 250M..... **\$192.50 ea.**
- (120) **529657** Free wheel. 1950-53 Champion, 1950-55 Commander with DG-200 transmission **\$85.80 ea.**
- (120) **535204** Free wheel. 1955-56 with DG-150, 150M & 200M, also 1954 Champion . **\$72.60 ea.**
- (120) **537053** Free wheel. 1955 with 250M **\$82.50 ea.**
- (121) **529650** Snap ring. 1950-56, all models **\$4.95 ea.**
- (122) **529658** Spacer. 1950-53 Champion, 1950-55 Commander with DG200 transmission **\$39.60 ea.**
- (122) **535216** Spacer. 1954 Champion..... **\$42.35 ea.**
- (122) **536346** Spacer. 1955-56 with DG-150, 150M, 200M & 250M..... **\$41.50 ea.**
- (123) **529659** Dowel. 1950-56, all models..... **\$1.20 ea.**
- (124) **529650** Snap ring. 1950-56, all models. **\$4.95 ea.**
- (125) **529663** Spacer. 1950-56, all models. **\$7.70 ea.**
- (126) **529662** Bearing. 1950-56 all models **\$46.20 ea.**
- (127) **529719** Reverse band. 1950-56, all models **\$76.45 Ex.**
- (128) **529714** Forward band. 1950-56, all models. Takes 2 **\$91.70 Ex.**
- (129) **529668** Snap ring. 1950-56, all models **\$5.90 ea.**

DG AUTOMATIC TRANSMISSION VALVE BLOCK & OIL PAN DG 150, DG 200

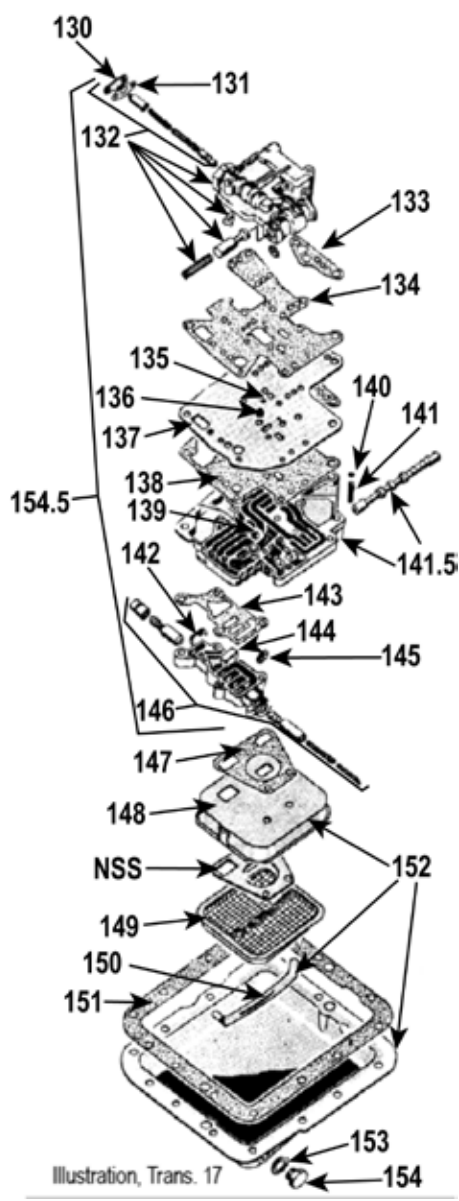

VALVE BLOCK GASKET SETS

- 534544** 1950-54, all models & 1955 with DG150 or 200 transmission **\$21.00 ea.**
- 537814** 1955 V-8 with DG200M or 250M transmission **\$21.00 ea.**
- 537956** 1955 Champion with DG150M..... **\$21.00 ea.**

NSS = NOT SOLD SEPARATELY

VALVE BLOCK PARTS DG150, DG200

- (131) **529749** Gasket. 1950-54, all models & 1955 w/DG150 or 200 trans..... **\$1.20 ea.**
- (132) **529741** Body complete. 1950-54, all models & 1955 w/DG150 or 200 trans..... **\$112.20 ea.**
- (133) **529733** Gasket. 1950-54, all models & 1955 w/ DG150 or 200 trans..... **\$1.40 ea.**
- (134) **529750** Gasket. 1950-54, all models & 1955 w/DG150 or 200 trans..... **\$2.60 ea.**
- (136 & 139) **G145643** Ball. 1950-54, all models & all 1955 except 150M, 200M & 250M transmission. **50¢ ea.**
- (135) **G145636** Ball. 1950-54, all models & 1955 with DG150 or 200 trans..... **75¢ ea.**
- (137) **529730** Plate. 1950-54, all models & 1955 with DG150 & 200 trans **\$33.00 ea.**
- (138) **529736** Gasket. 1955 with DG150 or 200 & 1950-54, all models. **\$5.90 ea.**
- (141) **529739** Spring. 1950-56, all models. **\$2.20 ea.**
- (141.5) **529734** .Plate. 1950-54, all models & 1955 w/DG150 or 200 trans..... **\$132.00 ea.**
- (142) **529761** Retainer. 1950-54, all models & 1955 w/DG150 or 200 trans..... **\$1.20 ea.**
- (143) **529756** Gasket. 1950-54, all models & 1955 w/DG150 or 200 trans..... **\$1.40 ea.**
- (144) **531578** Screen. 1950-54, all models & 1955 with DG150 or 200 trans..... **\$8.25 ea.**
- (145) **529753** Retainer. 1950-54, all models & 1955 w/DG150 or 200 trans..... **\$1.20 ea.**
- (146) **529754** Body complete. 1950-54, all models & 1955 with DG150 or 200 trans..... **\$85.80 ea.**
- (147) **529770** Gasket. 1950-54, all models & 1955 w/DG150 or 200 trans..... **\$1.40 ea.**
- (148) **529769** Shroud. Early 1950 Commander. . **\$13.20 ea.**
- (148) **529914** Shroud. Late 50 Commander, 1950 Champion, 1951-54, all models & 1955 w/ DG150 or 200 trans. **\$14.85 ea.**
- (149) **529767** Screen. 1950-54, all models & 1955 w/DG150 or 200 trans..... **\$30.00 ea.**
- (150) **529913** Retainer. Late 1950 Commander, 1950 Champion, 1951-54, all models & 1955 w/ DG150 or 200 trans..... **\$2.20 ea.**
- (151) **527783** Gasket. 1950-56, all models..... **\$11.45 ea.**
- (152) **529975** Pan kit. Some 1950-54 models & all 1955 models **\$27.50 ea.**
- (152) **534584** Pan kit. Some 1950-54, all models..... **\$27.50 ea.**
- (152) **529967** Pan kit. 1956 Champion. **\$27.50 ea.**
- (153) **527961** Gasket. 1950-56 all models. **\$1.20 ea.**
- (154) **529774** Plug. 1950-56 all models **\$4.95 ea.**
- (154.5) **529729** Valve block complete. 1950 Champion..... **\$214.50 ea.**
- (154.5) **529909** Valve block complete. 1950 Commander, 1951-54, all models. **\$223.00 ea.**

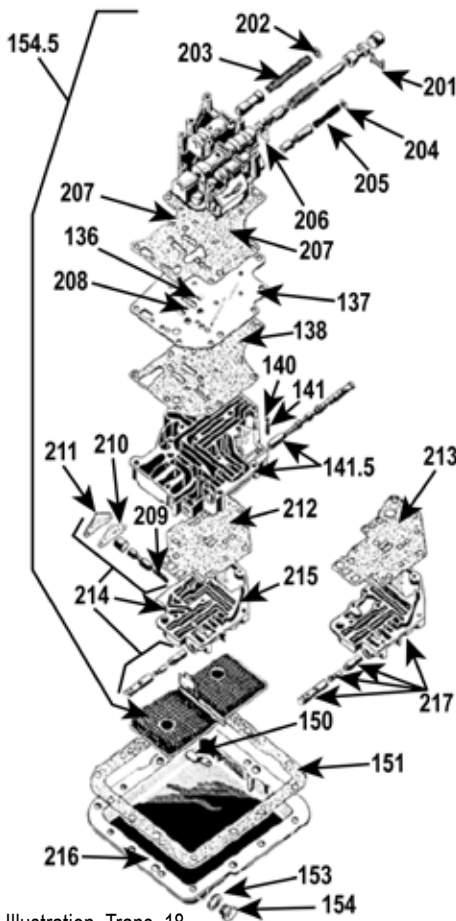

Illustration, Trans.-18

VALVE BLOCK & OIL PAN DG-150-M, DG-200-M, DG-250-M

- | | |
|---|--|
| (136) G145643 Ball. 1955-56, all models.....
..... 50¢ ea. | (202) 537251 Retainer. 1955-56, all models.....
..... \$3.85 ea. |
| (137) 537059 Plate. 1955-56 all models.....
..... \$27.50 ea. | (204) 529753 Retainer. 1955-56k all models.....
..... \$1.20 ea. |
| (138) 537063 Gasket. 1955-56, all models.....
..... \$4.95 ea. | (205) 529752 Spring. 1955-56, all models.....
..... \$2.20 ea. |
| (139) G145643 Ball. 1955-56, all models.....
..... 50¢ ea. | (206) 537248 Stop.....
..... \$1.20 ea. |
| (141) 529739 Spring. 1955-56, all models.....
..... \$2.20 ea. | (207) 537255 Gasket. 1955-56, all models.....
..... \$4.95 ea. |
| (141.5) 537794 Plate. 1955-56, all models.....
..... \$138.60 ea. | (208) G145643 Ball. 1955-56, all models.....
..... 50¢ ea. |
| (150) 536926 Retainer. 1955-56, all models.....
..... \$1.35 ea. | (210) 537266 Gasket. DG200M & 250M.....
..... \$1.20 ea. |
| (151) 527783 Gasket. 1955-56, all models.....
..... \$11.45 ea. | (212) 537799 Gasket. DG200M & 250M.....
..... \$2.75 ea. |
| (153) 527961 Gasket. 1955-56, all models.....
..... \$1.20 ea. | (213) 537793 Gasket. DG150M.....
..... \$2.75 ea. |
| (154) 529774 Plug. 1955-56, all models.....
..... \$4.95 ea. | (214) 537797 Body complete. DG250M after
trans. #SP-10801. Note: 537797 can also be
used on earlier 250M & 200M if 537794 plate is
also used..... \$97.35 ea. |
| (154.5) 537790 Valve block complete. 1955
with DG150M transmission..... \$260.50 ea. | (215) 537262 Retainer. 1955-56, all models.....
..... \$1.20 ea. |
| (154.5) 537796 Valve block complete. 1955
with DG200M or 250M transmission..... \$215.00 ea. | (216) 534584 Oil pan. 1955, all models.....
..... \$27.50 ea. |
| (200) 537240 Body complete. 1955-56, all
models..... \$115.50 ea. | (216) 529967 Oil pan. 1956, all models.....
..... \$27.50 ea. |
| | (217) 537791 Body complete. 1955-56
Champion with DG 150M transmission. 537794
Plate must also be used on early 1955.....
..... \$89.75/set |

TRANSMISSION CASE, SERVO UNITS, & BANDS DG-150, DG-150M, DG-200-M, DG-250-M

- | |
|--|
| (127) 529719 Reverse band. 1950-56,
all models..... \$76.45 Ex. |
| (128) 529714 Forward band. 1950-56,
all models. Takes 2..... \$91.70 Ex. |
| (156) 535447 Cylinder. 1954-56
Champion, 150 or 150M. \$41.50 ea. |
| (156) 537055 Cylinder. 1955 with
250M..... \$53.90 ea. |
| (156A) 535446 Cylinder. DG 200M.....
..... \$41.35 ea. |
| (156B) 535447 Cylinder. DG 150 &
150M..... \$41.50 ea. |
| (157) 529704 Seal. All models.....
..... \$16.50 ea. |
| (157A) See (165) |
| (158) 529701 Piston. DG 200.....
..... \$23.10 ea. |
| (158) 535703 Piston, outer lower
brake. DG 200M, DG 250M.....
..... \$18.15 ea. |
| (158A) 535597 Piston, upper forward
brake. DG150M-200M & 250M.....
..... \$44.00 ea. |
| (159/199) 527778 Seal. All models.....
..... \$2.75 ea. |
| (160) 529527 O-ring. All models.....
..... \$1.35 ea. |
| (161) 527960 Gasket. 1954 Champion, 1955 with DG200 or 200M transmission. \$2.90 ea. |
| (161) 535225 Gasket. 1955-56 with 150-150M & 250M.....
..... \$5.50 ea. |
| (162) 529707 Plate. 1955 with 200M.....
..... \$13.75 ea. |
| (162) 535223
..... \$5.00 ea. |
| (162) 537056 Plate. 1955 with 250M.....
..... \$13.75 ea. |

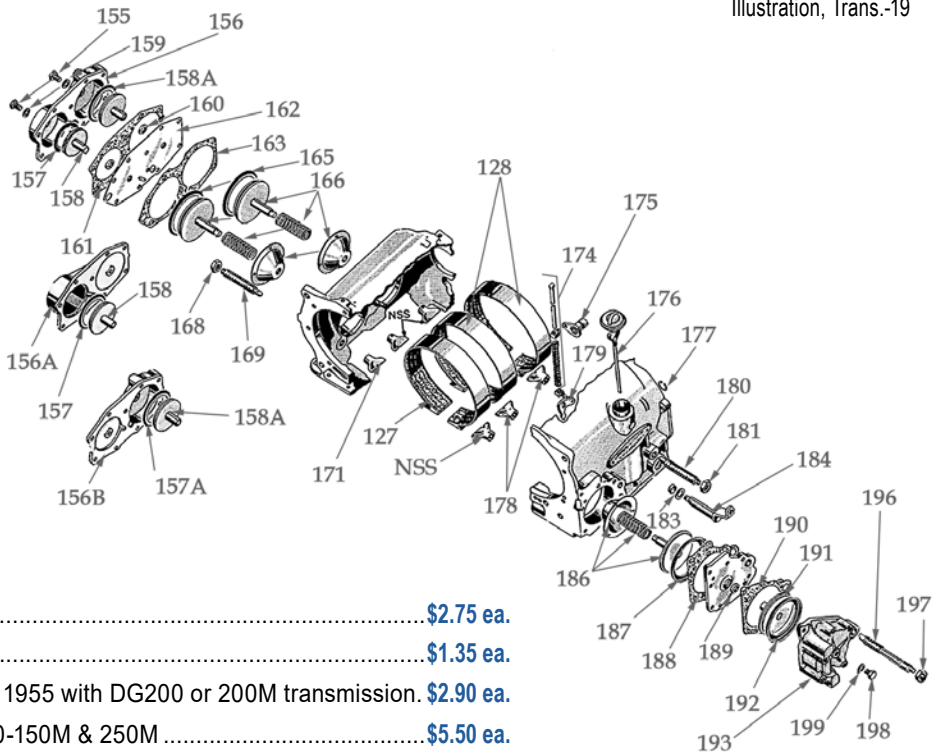

Illustration, Trans.-19

TRANSMISSION CASE, SERVO, UNITS, & BANDS (continued)
 DG-150, DG-150M, DG-200-M, DG-250-M

**DG 200 TRANSMISSION 1950-53 CHAMPION,
 1950-54 COMMANDER, & EARLY 1955
 COMMANDER WITH 224 ENGINE**

NSS = NOT SOLD SEPARATELY
 Illustration, Trans.-20

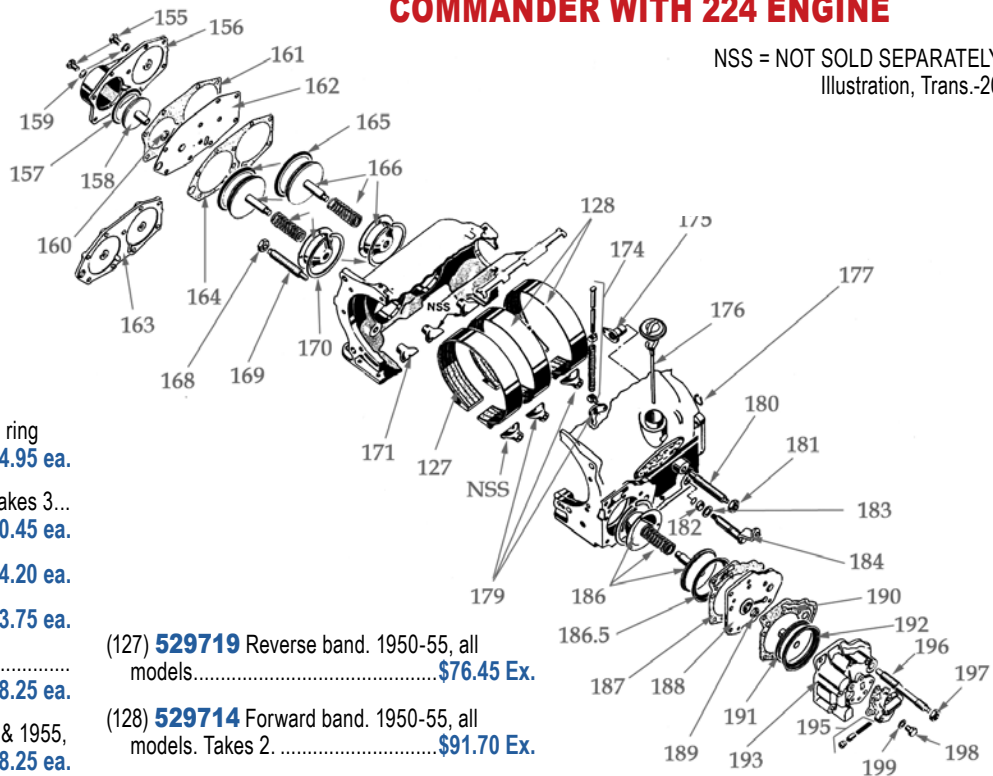

- (165/192/157A/186.5) **529697** Seal. 1954 Champion & all 1955-56 car. Takes 5..... **\$8.25 ea.**
- (166/167/186) **529690** Piston complete. All models. Takes 3..... **\$33.00 ea.**
- (168/181/197) **G114496** Nut. All models. Takes 3..... **\$1.20 ea.**
- (169) **529723** Screw. 1955-56 with 150, 150M or 200M..... **\$10.45 ea.**
- (169) **535712** Screw. 1954 Champion & 1955 with 250M trans..... **\$10.45 ea.**
- (170) **529698** Snap ring. Some 1954 Champion & 1955 car. Need only when ring groove is cast in case..... **\$4.95 ea.**
- (171 & 178) **529728** Strut. All models. Takes 3..... **\$10.45 ea.**
- (174) **529681** Rod. All models..... **\$24.20 ea.**
- (175) **529686** Lever. All models..... **\$13.75 ea.**
- (176) **529082** Dipstick. 1956 Champion..... **\$8.25 ea.**
- (176) **535452** Dipstick. 1954 Champion & 1955, all models..... **\$8.25 ea.**
- (177) **529689** Snap ring. All models... **\$1.65 ea.**
- (178) Refer to # (171)
- (179) **529680** Lever. 1954 Champion & 1955 with 150 or 150M trans..... **\$10.45 ea.**
- (179) **537054** Lever. 1955-56 with 150M, 200M, 250M trans..... **\$10.45 ea.**
- (180) **529723** Screw. 1955-56 with 150, 150M, 200M trans..... **\$10.45 ea.**
- (182) **535604** Seal. All models..... **\$13.20 ea.**
- (183) **535628** Washer. All models..... **\$1.10 ea.**
- (184) **535448** Shaft & lever. All models..... **\$18.15 ea.**
- (185) **529698** Snap ring. 1955 some models, see chassis parts book..... **\$4.95 ea.**
- (186) See (166) & (167)
- (186.5) **529697** See (165)
- (187) **535445** Gasket. All models..... **\$6.60 ea.**
- (188) **535615** Plate. All models..... **\$18.15 ea.**
- (189) **529527** O-ring. All models..... **\$1.35 ea.**
- (190) **535444** Gasket. All models..... **\$6.60 ea.**
- (191) **535597** Piston. All models..... **\$44.00 ea.**
- (192) See (165)
- (193) **535234** Cylinder. All models... **\$53.35 ea.**
- (196) **529722** Screw. All models..... **\$10.45 ea.**
- (197) **G114496** Nut. All models..... **\$1.20 ea.**
- (199) **527778** Washer. All models..... **\$2.75 ea.**

- (127) **529719** Reverse band. 1950-55, all models..... **\$76.45 Ex.**
- (128) **529714** Forward band. 1950-55, all models. Takes 2..... **\$91.70 Ex.**
- (156) **529706** Cylinder. All models..... **\$38.50 ea.**
- (157) **529704** Seal. Late 1950 & all 1951-54 Commander..... **\$16.50 ea.**
- (158) **529701** Piston. 1950-54 Commander..... **\$23.10 ea.**
- (159 & 199) **527778** Washer. All models..... **\$2.75 ea.**
- (160) **529527** O-ring. All models..... **\$1.35 ea.**
- (161) **527960** Gasket. 1950-54 Commander..... **\$2.90 ea.**
- (162) **529707** Plate. 1950-54 Commander..... **\$13.75 ea.**
- (164) **529919** Cover. 1950-53 Champion..... **\$33.00 ea.**
- (165 & 192) **529697** Seal. All models Takes 4..... **\$8.25 ea.**
- (166, 167 & 186) **529690** Piston. 1950 Champion, all 1951-54 except 1954 Champion. Takes 3..... **\$33.00 ea.**
- (168, 181, 197) **G114496** Lock nut. All models. Takes 3..... **\$1.20 ea.**
- (169) **529723** Screw. 1950-53 Champion..... **\$10.45 ea.**
- (170) **529698** Snap ring. All models... **\$4.95 ea.**
- (171 & 178) **529728** Strut. All models. Takes 3..... **\$10.45 ea.**
- (174) **529681** Rod. All models..... **\$24.20 ea.**
- (175) **529686** Lever. All models..... **\$13.75 ea.**

- (176) **529082** Dipstick. All models..... **\$8.25 ea.**
- (177) **529689** Snap ring. All models... **\$1.65 ea.**
- (179) **529680** Lever. All models..... **\$10.45 ea.**
- (180) **529723** Screw. All models..... **\$10.45 ea.**
- (182) **529677** Packing. All models..... **\$1.20 ea.**
- (182.5) **529678** Seal. All models..... **\$5.40 ea.**
- (183) **529679** Washer. All models..... **\$2.20 ea.**
- (184) **529764** Shaft & lever. All models..... **\$10.45 ea.**
- (185) **529698** Snap ring. See chassis parts book..... **\$4.95 ea.**
- (186) See (166) & (167)
- (187) **527957** Gasket. All models..... **\$2.20 ea.**
- (188) **529712** Plate. All models..... **\$24.20 ea.**
- (189) **529527** O-ring. All models..... **\$1.35 ea.**
- (190) **527958** Gasket. All models..... **\$2.20 ea.**
- (191) **529705** Piston. All models..... **\$27.50 ea.**
- (192) Refer to See (165)
- (193) **529710** Cylinder. All models... **\$53.35 ea.**
- (195) **529724** Valve. All models..... **\$27.50 ea.**
- (196) **529722** Screw. All models..... **\$10.45 ea.**
- (197) **G114496** Lock nut. All models.. **\$1.20 ea.**
- (199) **527778** Washer. All models..... **\$2.75 ea.**

FLIGHT-O-MATIC TRANSMISSION CASE, FRONT OIL PUMP, OIL PAN, ETC.

(Except AS835 & AS30-35 used in late 1963-66 6-cyl.)

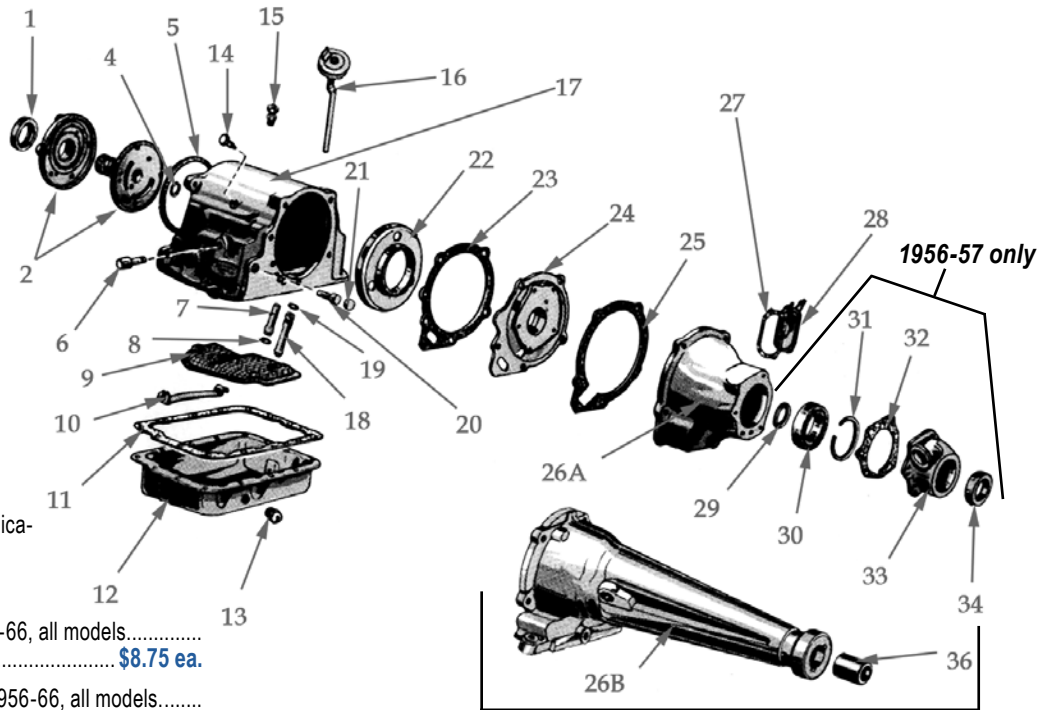

Illustration, Trans.-21

NOTE: For HD 6-cyl. Applications use V-8 Parts.

- | | | | | | | | | |
|---|---------------------------|---------------------|--|-------------------------------|--------------------------------------|---|----------------------------------|---------------------|
| (1) 1540922 Seal. 1956-66, all models..... | | \$8.75 ea. | (15) 1559002 Breather. 1963-64 all models..... | | \$11.00 ea. | (33) 1541092 Housing. 1956-57, all models..... | | \$71.50 ea. |
| (4) 1545274 Bushing. 1956-66, all models..... | | \$30.25 ea. | (15) 1559002 Breather. 1963-64 all models..... | | \$11.00 ea. | (34) 1541097 Seal. 1956-57 all models..... | | \$13.00 ea. |
| (5) 1540930 Gasket. 1956-66, all models..... | | \$10.45 ea. | (16) 1554224 Dipstick. 1963-64 6-cylinder | Lark. As 835 & 30-35..... | \$11.00 ea. | (34) 1553737 Seal. 1958-66, all models..... | | \$10.00 ea. |
| (6) 1540909 Pin. 1956-66, all models..... | | \$9.90 ea. | (16) 1554238 Dipstick tube. 1963-64 6-cylinder | Lark. As 835 & 30-35..... | \$11.00 ea. | (36) 1559902 Bushing. 1958-66, all models..... | | \$45.00 ea. |
| (8) 1541258 O-ring. 1956-66, all models..... | | \$1.65 ea. | (17) 1540900 Case. 1956-60 all except some | 1957..... | \$192.50 ea. | (37) 1541185 Snap ring. 1956-66, all models... | | \$9.90 ea. |
| (9) 1545195 Strainer. 1956-66, all models. | (incl. gasket)..... | \$51.00 ea. | (17) 1552993 Case. 1961-64 all except floor | shift..... | \$253.00 ea. | (38) 1541169 Thrust washer. 1956-66 all | models..... | \$9.90 ea. |
| (10) 1541250 Clip. 1956-66, all models..... | | \$19.25 ea. | (17) 1564819 Case. 1965-66 V-8..... | | \$453.00 ea. | (39) 1541166 Shaft. 1956-66, all models..... | | \$181.50 ea. |
| (11) 1540935 Gasket. 1956-66, all models..... | | \$11.00 ea. | (17) 1543059 Case. 1957 some models & all | 1958..... | \$252.00 ea. | (40) 1541184 Thrust washer. 1956-66, all | models..... | \$9.90 ea. |
| (12) 1540931 Pan. 1956-60, all models & 1961 | Hawk..... | \$43.45 ea. | (18) 1541255 Tube. 1956-66, all models..... | | \$12.65 ea. | (41) 1554230 Disc. 1956-66, all models. | Takes 4..... | \$11.00 ea. |
| (12) 1553015 Pan. 1961-66, all models except | 1961 Hawk..... | \$55.00 ea. | | | | (42) 1541182 Plate. 1956-66, all models except | 1961-63 6-cylinder. Takes 3..... | \$9.25 ea. |
| (15) 1540916 Breather. 1959-62 all models..... | | \$45.00 ea. | | | | (42) 1541202 Plate. 1961-63 6-cylinder. | Takes 2..... | \$12.05 ea. |
| (16) 1554224 Dipstick. 1963-64 6-cylinder | Lark. As 835 & 30-35..... | \$11.00 ea. | | | | (43) 1543339 Plate. 1956-66, all models..... | | \$43.50 ea. |
| (16) 1554238 Dipstick tube. 1963-64 6-cylinder | Lark. As 835 & 30-35..... | \$11.00 ea. | | | | (43) 1554179 Plate. 1961-63 6-cylinder..... | | \$11.30 ea. |
| (17) 1540900 Case. 1956-60 all except some | 1957..... | \$192.50 ea. | | | | (44) 1541183 Hub. 1956-66, all models..... | | \$82.60 ea. |
| (17) 1552993 Case. 1961-64 all except floor | shift..... | \$253.00 ea. | | | | | | |
| (17) 1564819 Case. 1965-66 V-8..... | | \$453.00 ea. | | | | | | |
| (17) 1543059 Case. 1957 some models & all | 1958..... | \$252.00 ea. | | | | | | |
| (18) 1541255 Tube. 1956-66, all models..... | | \$12.65 ea. | | | | | | |
| | | | (19) 1541256 O-ring. 1956-66, all models..... | | \$8.80 ea. | | | |
| | | | (20) 1541037 Pin. 1956-66, all models..... | | \$14.30 ea. | | | |
| | | | (22) 1541205 Support & Bushing. 1956-66 all | V-8 & 1959-60 6-cylinder..... | \$38.50 ea. | | | |
| | | | (23) 1541127 Gasket. 1956-66, all models..... | | \$9.90 ea. | | | |
| | | | (24) 1541114 Rear pump. 1956-57 all models..... | | \$151.25 ea. | | | |
| | | | (25) 1541087 Gasket. 1956-66, all models..... | | only available in kit number 1555513 | | | |
| | | | (26A) 1541082 Housing. 1956-57 all models..... | | \$115.50 ea. | | | |
| | | | (26B) 1545489 Housing. 1958-64 all models..... | | \$181.50 ea. | | | |
| | | | (26B) 1564827 Housing. 1965-66 V-8..... | | \$148.50 ea. | | | |
| | | | (27) 1541085 Gasket. 1956-66, all models..... | | \$6.60 ea. | | | |
| | | | (28) 1541084 Cover. 1956-66, all models..... | | Call for availability and price. | | | |
| | | | (30) 1541089 Bearing. 1956-57, all models..... | | \$84.00 ea. | | | |
| | | | (32) 1541093 Gasket .009-.011. 1956-57, all | models..... | \$4.95 ea. | | | |
| | | | (32) 1541094 Gasket .0135-.0165. 1956-57, all | models..... | \$4.95 ea. | | | |
| | | | (32) 1541095 Gasket .018-.022. 1956-57 all | models..... | \$5.50 ea. | | | |
| | | | (32) 1541096 Gasket .0225-.0275. 1956-57, all | models..... | \$4.95 ea. | | | |

FLIGHT-O-MATIC TRANSMISSION INTERNAL PARTS (Exploded view)

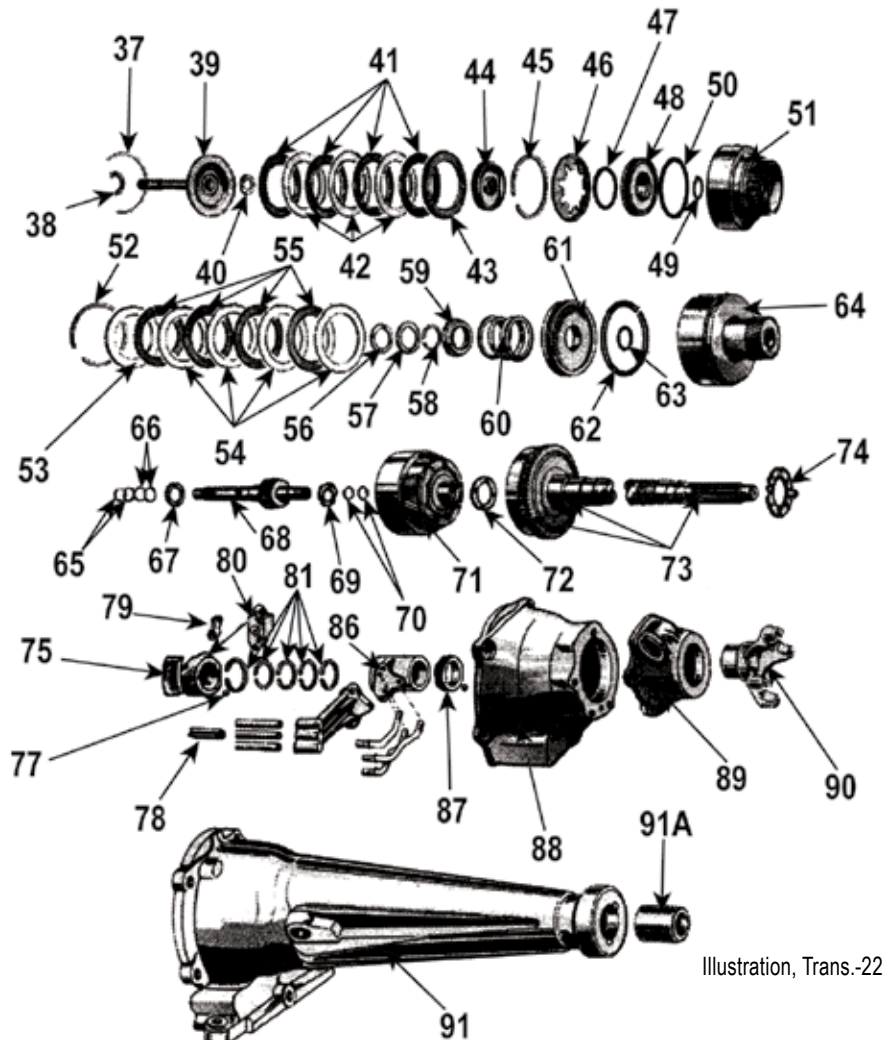

Illustration, Trans.-22

- | | |
|---|--|
| <p>(45) 1541179 Snap ring. 1956-66, all models \$9.90 ea.</p> <p>(46) 1541177 Spring. 1956-66, all models \$26.95 ea.</p> <p>(47) 1541178 Ring. 1956-66, all models \$7.70 ea.</p> <p>(48) 1541175 Piston. 1956-66, all models except with floor shift \$60.00 ea.</p> <p>(49) 1541174 O-ring. 1956-66 all models \$3.30 ea.</p> <p>(50) 1541176 O-ring. 1956-66 all models \$6.60 ea.</p> <p>(51) 1541171 Cylinder. 1956-66, all models except 1961-63 6-cylinder \$115.50 ea.</p> <p>(51) 1554227 Cylinder. 1961-63 6-cylinder \$149.60 ea.</p> <p>(52) 1541185 Snap ring. 1956-66, all models \$9.90 ea.</p> <p>(53) 1541203 Plate. 1956-66, all models \$38.50 ea.</p> <p>(54) 1541202 Plate. 1956-66, all models. Takes 4 except 1961-63 6-cylinder takes 3. \$12.05 ea.</p> <p>(55) 1543088 Disc. 1956-66, all models. Takes 4 \$23.25 ea.</p> <p>(56) 1541172 Thrust washer. 1956-66, all models \$8.80 ea.</p> | <p>(57) 1541173 Thrust washer. 1956-66, all models \$16.50 ea.</p> <p>(58) 1541200 Snap ring. 1956-66, all models \$4.40 ea.</p> <p>(59) 1541199 Retainer. 1956-66, all models \$11.00 ea.</p> <p>(60) 1541198 Spring. 1956-64, all models \$23.65 ea.</p> <p>(61) 1543089 Piston. 1956-64, all models except 1958 Packard Hawk & Golden Hawk & all models from 1959-60 \$60.50 ea.</p> <p>(61) 1544215 Piston. 1958 Golden & Packard Hawk, all 1959-60 car & all 1965-66 V-8 \$39.60 ea.</p> <p>(62) 1541197 Oil seal. 1956-66, all models \$9.90 ea.</p> <p>(63) 1541195 Oil seal. 1956-66, all models \$9.90 ea.</p> <p>(64) 1541187 Gear & drum. All 1956, some 1957 & 58, 1959-60 6-cylinder, all 1959-66 V-8 except floor shift \$148.50 ea.</p> <p>(64) 1543085 Gear & drum, some 1957 & 1958 cars & 1963-64 V-8 with floor shift \$192.50 ea.</p> <p>(65) 1541237 Oil ring. 1956-66 all models \$12.10 ea.</p> |
|---|--|
-
- | |
|--|
| <p>(66) 1541238 Oil ring. 1956-66 all models \$9.90 ea.</p> <p>(67) 1548928 Thrust washer. 1956-66 all models \$6.60 ea.</p> <p>(68) 1543064 Shaft & gear. 1956-64, all models \$192.50 ea.</p> <p>(69) 1553382 Thrust washer. 1956-66, all models \$9.90 ea.</p> <p>(70) 1541239 Oil ring. 1956-66, all models. Takes 2 \$8.80 ea.</p> <p>(71) 1541210 Drum with gears. 1956-58 all models, 1956-60 6-cyl, 1959-66 V-8 except with floor shift \$243.00 ea.</p> <p>(72) Thrust washer. 1956-66, all models.
 1541226:061-.063
 1541227:067-.069
 1541228:074-.076
 1541229:081-.083
 1541230:092-.094
 1541231:105-.107
 \$12.10 ea.</p> <p>(73) 1541240 Shaft & gear. 1956-57 all models \$253.00 ea.</p> <p>(73) 1545839 Shaft & gear. 1958 all models, 1959-60 6-cylinder, 1959-66 V-8 without floor shift \$253.00 ea.</p> <p>(73) 1553000 Shaft & gear. 1961-63 6-cyl & V-8 with floor shift \$323.40 ea.</p> <p>(75) 1541100 Weight. 1956-57 all models & 1958 Champion \$28.00 ea.</p> <p>(75) 1545491 Weight. 1963-64 V-8 with floor shift & all 1965-66 V-8 \$93.50 ea.</p> <p>(79) 1541354 Governor. 1956-60 Champion 6-cylinder & 1956-57 Commander. \$55.00 ea.</p> <p>(80) 1541099 Snap ring. 1956-66, all models \$4.40 ea.</p> <p>(81) 1541248 Oil ring. 1956-66, all models. Takes 4 \$1.50 ea.</p> <p>(82) 1541110 Collector. 1956-57, all models \$33.00 ea.</p> <p>(86) 1541109 Sleeve. 1956-57, all models \$44.00 ea.</p> <p>(87) Call for availability & price</p> <p>(88) 1541082 Housing. 1956-57, all models \$115.50 ea.</p> <p>(89) 1541092 Housing. 1956-57, all models \$71.50 ea.</p> <p>(91) 1545489 Housing. 1958-64, all models \$181.50 ea.</p> <p>(91) 1564827 Housing. 1965-66 V-8 \$148.50 ea.</p> <p>(91A) 1559902 Bushing. 1958-66, all models .. \$45.00 ea.</p> |
|--|

FLIGHT-O-MATIC TRANSMISSION SERVO UNITS & BANDS

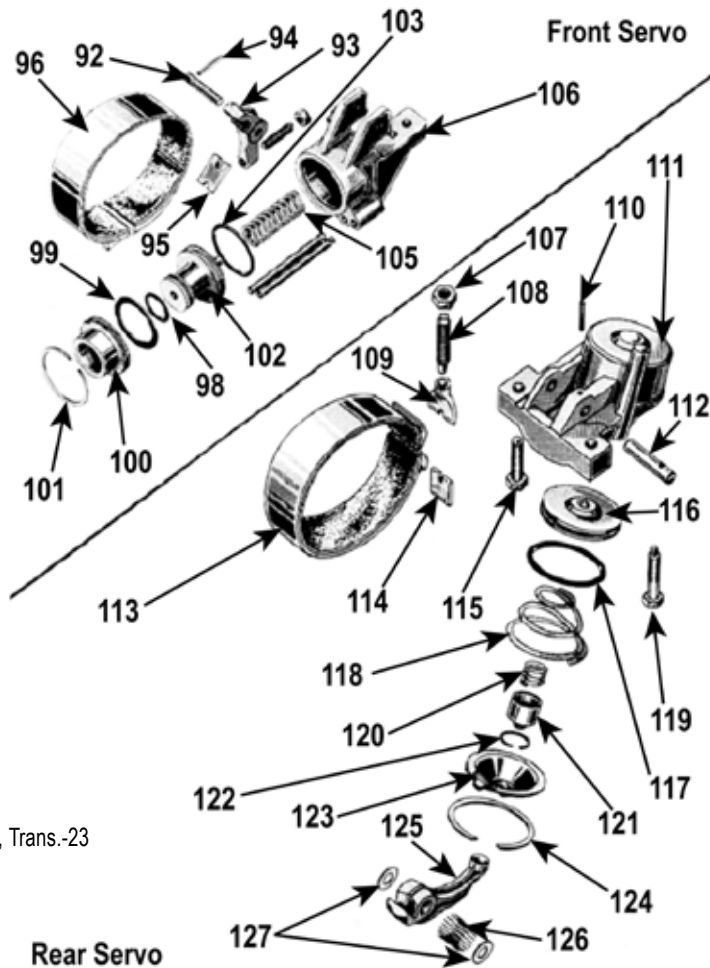

Illustration, Trans.-23

FRONT SERVO

- (92) **G453674** 60¢ ea.
- (93) **1541058** Lever. 1956-66, all models.....
..... Call for availability and price
- (95) **1541156** Strut. 1956-66, all models.....
..... \$11.00 ea.
- (96) **1541146** Front band. 1956 all models,
1957 Champion & some V-8, also all 1958-60
car \$82.50 ea.
- (96) **1543070** Front band. Some 1957 V-8,
1958, all models, 1963-64 with floor shift.....
..... \$114.40 ea.
- (96) **1551375** Front band. 1961-63 6-cylinder,
1959-66 V-8 except with floor shift.. \$82.50 ea.
- (98) **1541051** O-ring. 1956-60 Champion
6-cylinder \$7.70 ea.
- (98) **1541052** O-ring. 1956 all models & some
1957 V-8 with 259 engine..... \$7.70 ea.
- (98) **1541139** O-ring. Some 1957 & all 1958
V-8 and all with 289 V-8 1959-66..... \$7.70 ea.
- (98) **1553007** O-ring. 1961-63 6-cylinder.....
..... \$7.00 ea.
- (99) **1541055** Seal. 1956-60 Champion. 1956
all models, some 1957-58 with 259 V-8 engine.
1963-64 V-8 with floor shift. \$7.70 ea.
- (99) **1541142** Seal. Some 1957-58 V-8 with
259 V-8 engine, 1961-63 6-cylinder, all 1959-
66 V-8 and all with 289 engine \$7.70 ea.
- (100) **1541054** Guide. 1956-60 6-cylinder
..... \$19.25 ea.

- (100) **1541136** Guide. 1958 all models & some
1957 V-8 259 \$24.75 ea.
- (100) **1553008** 1961-63 6-cylinder.....
..... \$19.25 ea.
- (100) **1541137** Guide. Some 1957-58 with 259
V-8, all with 289, 1959-66 V-8 all except floor
shift \$21.45 ea.
- (101) **1541056** Snap ring, for 1541054 &
1541136 \$11.00 ea.
- (101) **1541141** Snap ring for 1541137 &
1553008..... \$4.95 ea.
- (102) **1541048** Piston. 1956-60 6-cylinder
..... \$40.00 ea.
- (102) **1541132** Piston. All 1956 & some 1957
with 259 V-8. \$40.00 ea.
- (102) **1553006** Piston. 1961-63 6-cylinder.....
..... \$40.00 ea.
- (102) **1541133** Piston. Some 1957-58 with 259
V-8, all with 289, 1959-66 V-8 all except floor
shift \$40.00 ea.
- (103) **1541052** O-ring. 1956-60 6-cylinder 1956
all models & some 1957 with 259 V-8 & 1963-
64 V-8 with floor shift. \$7.70 ea.
- (103) **1541140** O-ring. Some 1957-58 with 259
V-8, all with 289, 1961-63 6-cylinder & 1959-64
V-8 with floor shift. Also all 1965-66 V-8.....
..... \$7.15 ea.
- (105) **1541053** Spring. 1956-60 6-cylinder, all
1956 & some 1957 & 58 with 259 V-8.....
..... \$7.70 ea.
- (105) **1541143** Spring. Some 1957 & 58 with
259 V-8, all with 289, 1959-66 V-8 all models...
..... \$11.00 ea.

- (106) **1541057** Housing. 1956-58 6-cyl, 1956
all models & some 1957 with 259 V-8
..... \$71.50 ea.
- (106) **1541144** Housing. Some 1957-58 with
259 V-8..... \$71.50 ea.

REAR SERVO

- (107-109)..... No Stock
- (110) **G453674**..... 60¢ ea.
- (111) **1541076** Housing. 1956-64 all models &
some 1965-66 V-8 \$98.25 ea.
- (111) **1565987** Housing. Some 1965-66 V-8
..... \$82.50 ea.
- (112) **1541072** Pin. Fits 1541076 HSG.....
..... \$14.85 ea.
- (113) **1541157** Rear band, 1956-66 All..... Call
- (114 & 115)..... No Stock
- (116) **1541063** Piston. 1956-66, all models.....
..... \$44.00 ea.
- (117) **1541064** O-ring. 1956-66, all models.....
..... \$8.80 ea.
- (118) **1541068**..... No Stock
- (119) **1541080** Screw. 1956-66, all models.....
..... \$3.30 ea.
- (120-22)..... No Stock
- (123) **1541066** Retainer. 1956-66, all models....
..... \$14.85 ea.
- (124) **1541067** Snap ring. 1956-66, all models..
..... \$9.90 ea.
- (125) **1541071** Lever. 1956-66, all models.....
..... \$38.50 ea.
- (126-127)..... No Stock

CONTROL VALVE

- (128) **1540943** Valve. 1956-56 6-cylinder all
models and early 1956 V-8 \$283.80 ea.
- (128) **1542992** Valve. 1956-57 V-8 all models
except Golden Hawk \$283.80 ea.
- (128) **1543076** Valve. 1957 Golden Hawk &
Packard..... \$283.80 ea.
- (128) **1545458** Valve. 1958 V-8 all models
except Golden & Packard Hawk.... \$283.80 ea.
- (128) **1545461** Valve. 1958 Golden & Packard
Hawk \$283.80 ea.
- (128) **1564830** Valve. 1965-66 V-8.....
..... \$283.80 ea.
- (129) **1540966** Plate. 1956-64 all models.....
..... \$11.55 ea.
- (130) **1541548** Spring.....
..... use 1541549 spring kit
- (133) **1542984** Plate. 1956-58, all models.....
..... \$27.50 ea.
- (134) **1540966** Plate. 1956-66, all models.....
..... \$11.55 ea.
- (49,136,137) **1541549** Spring set. Late 1956
and all 1957 V-8. Contains 1 each - 1541546,
1541547, 1541548..... \$9.90 ea.
- (140) **1540993** Plate. 1956-66, all... \$18.15 ea.
- (141) **1540995** Plate. 1956-64, all.... \$33.00 ea.
- (141) **1564831** Plate. 1965-66 V-8... \$39.60 ea.

FLIGHT-O-MATIC

Transmission Control & Oil Regulator Valve

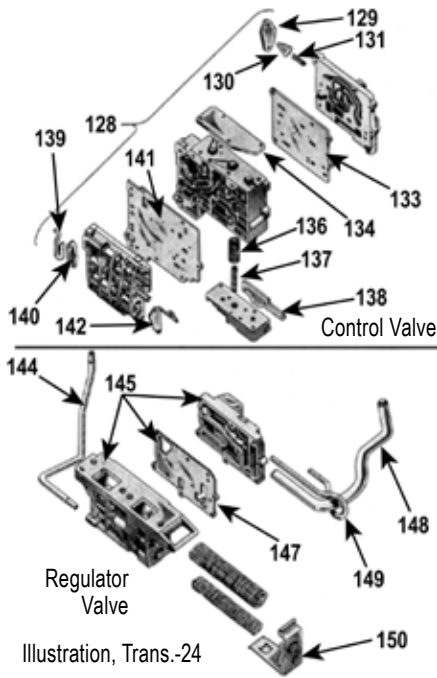

REGULATOR VALVE

- (144) **1541251** Tube. 1956-66, all models.....
..... **\$19.80 ea.**
- (145) **1541701** Regulator. 1956-57 V-8 all
models & early 1958 V-8. Not used on Packard
or Golden Hawk..... **\$148.50 ea.**
- (145) **1543079** Regulator. Late 1958 V-8 & all
1957-58 Golden Hawk & Packard
..... **\$148.50 ea.**
- (145) **1546108** Regulator. 1965-66 V-8.....
..... **\$148.50 ea.**
- (147) **1541009** Plate. 1956-66, all models.....
..... **\$9.90 ea.**
- (148)..... No Stock
- (149)..... No Stock
- (150) **1541005** Retainer. 1956-66, all models ...
..... **\$5.50 ea.**

Illustration, Trans.-25

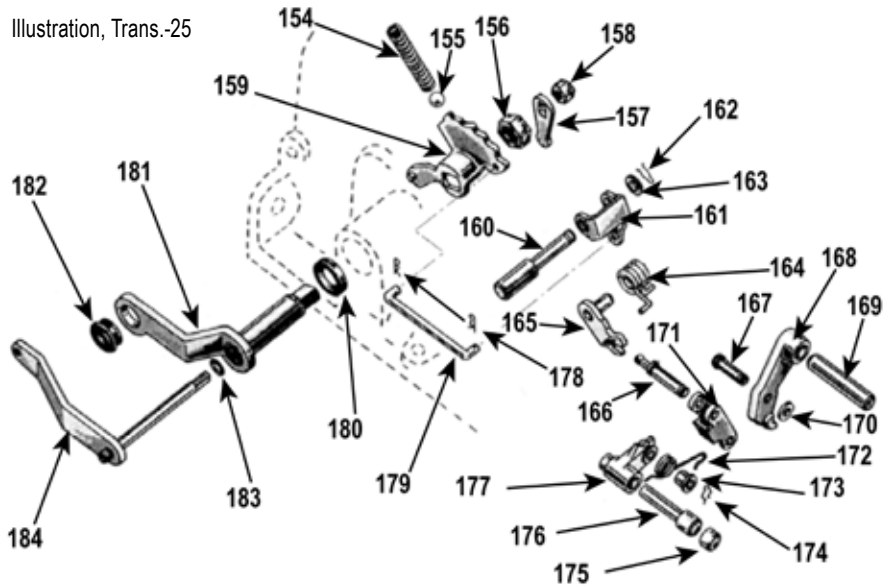

FLIGHT-O-MATIC PARKING LINKAGE, THROTTLE AND LEVERS

LINKAGE

- (154) **1541023** Spring. 1956-66, all models
..... **\$4.95 ea.**
- (155) **G453593** Ball..... **\$2.00 ea.**
- (156) **1541022** Nut. 1956-66, all models.....
..... **\$7.70 ea.**
- (157) **1541024** Lever. 1956-64, all models.....
..... **\$9.90 ea.**
- (158) **1541025** Nut. 1956-64, all models.....
..... **\$2.00 ea.**
- (159) **1541019** Lever. 1956-64, all models.....
..... **\$24.20 ea.**
- (159) **1564826** Lever. 1965-66 all models.....
..... **\$24.20 ea.**
- (160) **1540909** Pin. 1956-66, all models.....
..... **\$9.90 ea.**
- (161) **1541028** Lever. 1956-66, all models.....
..... Call for availability and price.
- (162) **1541030** Clip. 1956-66, all models.....
..... **\$2.20 ea.**
- (163)..... No Stock
- (165) **1541031** Lever. 1956-66, all models.....
..... **\$18.15 ea.**
- (166) **1541043** Pin. 1956-64, all models.....
..... **\$8.80 ea.**
- (166) **1564810** Pin. 1965-66, all models.....
..... **\$8.25 ea.**
- (167) **1541045** Pin. 1956-66, all models.....
..... **\$5.50 ea.**
- (168) **1541036** Pawl. 1956-66, all models.....
..... **\$31.35 ea.**
- (169) **1541035** Pin. 1956-66, all models.....
..... **\$14.85 ea.**
- (171) **1541044** Link. 1956-66 all models.....
..... **\$18.15 ea.**
- (172) **1541040** Spring. 1956-64, all models
..... **\$5.50 ea.**
- (172) **1564809** Spring. 1965-66, all models.
..... **\$1.10 ea.**
- (173) **1541041** Retainer. 1956-64, all models....
..... **\$6.05 ea.**
- (174) **1541042** Clip. 1956-64, all models.....
..... **\$1.65 ea.**
- (175) **1541038** Retainer. 1956-66, all models....
..... **\$3.85 ea.**
- (176) **1541037** Pin. 1956-66 all models.....
..... **\$14.30 ea.**
- (177) **1541039** Lever. 1956-66 all models.....
..... **\$24.20 ea.**
- (178) **1541027** Clip. 1956 only..... **\$2.20 ea.**
- (179) **1541026** Rod. 1956-66, all models.....
..... **\$9.90 ea.**
- (180) **1540906** Seal. 1956-66, all models.....
..... **\$6.60 ea.**
- (181) **1541011** Lever. 1956-64, all models.....
..... **\$24.20 ea.**
- (181) **1564825** Lever. 1965-66, all models.....
..... **\$24.20 ea.**
- (182) **1539489** Insulator. 1956-66, all models ...
..... **\$8.00 ea.**
- (183) **1541018** Seal. 1956-64, all models.....
..... **\$6.60 ea.**
- (184) **1541015** Lever. 1956-64, all models.....
..... **\$31.35 ea.**

**Call &
Place
Your Order
Today!
(317) 462-3124**



Oskar Kornmuller's 1950
Champion Starlight Coupe
from Villach, Austria



BRAKE SECTION GLOSSARY

Brake, Clutch & Pedal Related Parts	247	Brake Drums & Related Parts.....	251-252
Parking Brake Related Parts.....	247-248	Disc Brakes & Related Parts	253-254
Calipers.....	248	Wheel Cylinders & Related Parts.....	254
Boosters & Related Parts	249	Master Cylinders & Related Parts.....	255
Self Adjuster Parts.....	250		

BRAKE & CLUTCH PEDAL PADS

(Parts used on both drum & disc brake equipped vehicles.)

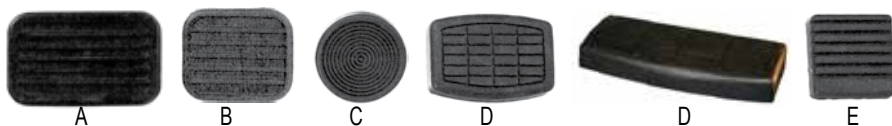

- (A) **536378** 1955-60 car, all models with automatic trans. 1961-64 Hawk with auto trans..... **\$24.00 ea.**
 (B) **537288** 1955-60 car, all models with standard trans. 1961-64 Hawk with standard trans..... **\$22.00 ea.**
 (C) **675269** 1939-46 Champion. 1941-42 Commander & President. 1947-54 car, all models with standard transmission. Truck: 1941-59 all models. 1960-64 C-cab..... **\$18.00 ea.**
 (D) **1552334** With standard transmissions, 1961-66 Lark and 1963-early Avanti II. Truck: 1963-64 Champ..... **\$18.00 ea.**
 (D) **1552335** 1961-66 Lark, 1963-85 Avanti with automatic transmission **\$24.00 ea.**
 (E) **1562901** 1964-66 Lark emergency brake..... **\$15.00 ea.**

BRAKE & CLUTCH PEDAL SEALS



- 194562** 1939-46 Champion. 1941-42 Commander & President 1941-48 M-series truck **\$5.00 ea.**

- 519635** 1947-50 car, all models **\$3.00 ea.**



- 530366** 1951-58 car, all models. 1959-64 Hawk..... **\$3.00 ea.**

- 678478** Truck: 1949-59 all models..... **\$3.00 ea.**

- 1548523** 1959-60 Lark. Truck: 1960-64 Champ **\$3.00 ea.**



- 1689336** Truck: 3E, 4E, 5E, 6E 40. 7E, 8E 15, 25, 35, 40, 45..... **\$3.00 ea.**

BRAKE & CLUTCH PEDAL BUSHINGS

- 1543913** Brake only, 1958-60 sedan includes Lark & 1958 - 64 Hawk. Takes 2..... **\$5.50 ea.**



- 1543914** Clutch & brake, 1961-66 all models except C & K & 1963-85 Avanti. If your pedal wobbles, these probably need replacing. Takes 2..... **\$4.50 ea.**

PARKING BRAKE CABLE GUIDE

532669

Left rear. 1953-66 all models except convertible & 1963-66 Wagonaire. Right rear. 1960-64 convertible, 1963-66 Wagonaire & 1963-85 Avanti..... **\$20.00 ea.**



- 1549483** Left rear. 1960-64 convertible, 1963-66 Wagonaire & 1963-85 Avanti. **\$20.00 ea.**

REAR PARKING BRAKE CABLES



- 519796** 1947-50 Commander. NOS. **\$90.00 ea.**

- 519797** 1947-49 Land Cruiser. NOS **\$44.00 ea.**

- 530181** 1951-52 Land Cruiser. NOS **\$47.75 ea.**

- 533055** 1953-58 sedan except Land Cruiser. NOS..... **\$99.95 ea.**

- 533065** 1954-64 C & K includes Hawk & 1954-58 Land Cruiser 4-door plus President long wheel base 4 door sedan **\$106.65 ea.**

- 535108** Adjusting rod. 1954-63 car, all models & 1964 Hawk. Truck: 7E, 8E 5, 7, 10, 12..... **\$13.25 ea.**

- 674292** Truck: 2R, 3R, E 5, 6, 7..... **\$98.00 ea.**

- 1547885** 1959-62, 2-door Lark sedan & hardtop. 4-door Lark sedan. 1963-66 2-door sedan or hardtop..... **\$152.00 ea.**

- 1547886** 1959-66 Lark station wagon without sliding roof. 1964 Cruiser. 1962-66 4-door sedan.. **\$110.00 ea.**

- 1549688** 1960-64 convertible **\$78.00 ea.**
1558235 1963-66 2-door Lark sedan & hardtop with front disc brakes **\$150.00 ea.**

- 1558236** 1963-66 4-door Lark & station wagon without sliding roof & with front disc..... **\$88.00 ea.**

- 1558237** 1963-64 Lark convertible & 1963-75 Avanti with front disc..... **\$99.95 ea.**

- 1558238** 1963-64 Hawk with front disc. **\$88.00 ea.**

- 1558239** 1963-66 Wagonaire with sliding roof with front disc..... **\$88.00 ea.**

- 1559954** 1963-66 Wagonaire with sliding roof. **\$88.00 ea.**

- 1694783** Truck: 5E to 7E 122 models 10, 11, 12. 8E 122 models 5, 7, 10, 12..... **\$88.00 ea.**

FRONT PARKING BRAKE CABLES & SPRINGS

- 519844** Cable only. 1947-49 Champion & Commander. NOS..... **\$24.00 ea.**

- 520397** Front emergency brake anchor spring. 1947-50 all except automatic transmission **\$11.00 ea.**

- 526387** Cable only. 1950 Champion. NOS. **\$55.80 ea.**

- 526388** Cable only. 1950 Commander & Land Cruiser. NOS..... **\$55.80 ea.**

- 530083** Front emergency brake anchor spring. 1950 Champion with automatic transmission..... **\$15.00 ea.**

- 530616** Cable only. All 1951-52 car. **\$30.00 ea.**

- 530128** Front emergency brake anchor spring. 1951-52, all **\$15.00 ea.**

- 533020** Cable only. 1953 sedan..... **\$34.80 ea.**

- 537719** Cable only. 1955 sedan with wraparound windshield. 1956-58 sedan & 1958-64 Hawk..... **\$102.00 ea.**

- 1547905** Cable only. 1959-60 Lark except convertible & 1954-57 C & K **\$96.00 ea.**

- 1554476** Cable only. 1962-63 Lark except convertible **\$78.00 ea.**

- 1554477** Cable only. 1962-63 convertible, 1963-71 Avanti & 1963 Wagonaire..... **\$90.00 ea.**

- 1692256** Cable only. Truck: 1960-64 Champ.... **\$96.00 ea.**

FRONT PARKING BRAKE PARTS

- 1701186** Center parking brake handle seal. 1976-85 Avanti **\$8.00 ea.**



- 523222** Spring with clamp. All 1947 car & early 1948 convertible. **\$10.50 ea.**



- 523966** Tube with spring & bracket. All 1947 car & early 1948 convertible **\$31.20 ea.**



- 525621** Complete front handbrake assembly. All 1949 car..... **\$56.50 ea.**

- 525627** Handle & plunger. All 1949 car & some 1950 car **\$31.25 ea.**

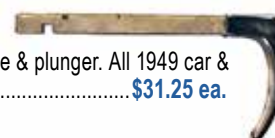

FRONT PARKING BRAKE PARTS (Continued)

525634 Cable & ends. All 1949 car.....
 \$18.00 ea.
527640 Guide & pawl kit. 1950 car. Refer to Chassis parts book.....
 \$41.50 ea.



530612 Rod & button. 1951-54 car.....
 \$18.00 ea.

530743 Handle & plunger. All 1951-52 car.....
 \$26.50 ea.



532972 Complete assembly. 1953 sedan.....
 \$90.00 ea.

533014P Guide. 1954 sedan..... \$31.25 ea.



533015P Guide. 1958 C & K \$31.25 ea.

533019 Handle & plunger. 1953 car.....
 \$22.25 ea.

535321 Guide. 1954 Champion & 1955-57 sedan.....
 \$31.25 ea.

535325 Handle spring. Holds handle in place when engaged. 1955-63, all models; 1964 Hawk & 1963-76 Avanti with hand parking brake. If your handle won't stay out when pulled, this spring needs to be replaced.....
 \$4.50 ea.



535513 Handle & plunger. All 1954 Champion including C & K; 1954 Champion sedan & all 1955 except with curved windshield. \$31.25 ea.

535514 Handle & plunger. 1954 Commander C&K, 1955 sedan with curved windshield & all 1956-58 models..... \$31.25 ea.

684785 Retainer clip. Lever arm to rear shoe 1963-64 Hawk, 1963-66 Lark & 1963-75 Avanti with front disc. Truck: E-2E 5, 6, 7 & 3E-6E 1, 2, 3, 5, 6, 7 & 7E 5, 7. \$3.95 ea.



1546335 Spring, cable pull back. 1958-63 car, all models; 1964 Hawk & 1963-85 Avanti.....
 \$11.00 ea.



1548302 Pin, parking brake handle. 1959-63 Lark, 1959-63 Hawk, 1963-83 Avanti..... \$5.50 ea.

1551997 bulb, flashing, brake warning light, 12-volt. \$7.25 ea.



1554483 Handle & pin. 1959-63 all Lark, 1959-61 Hawk & 1963-1976 Avanti with hand parking brake..... \$16.00 ea.



1555606 Handle & plunger, 1959-63 Lark. Truck: 1960-64 Champ..... \$40.00 ea.



1563632 Release handle. 1964-66 Lark. \$12.00 ea.

1564311 Plastic grommet, release rod. 1964-66 Lark..... \$4.25 ea.



SILICONE BRAKE FLUID

800395 Dot 5, 12 oz. \$12.90 ea.

FRONT CALIPER

1558182 1963-64 Hawk, 1963-66 Lark, 1963-83 Avanti. New & completely assembled with seals and piston. Takes 4 \$155.00 ea.



FRONT CALIPER PARTS

For 1963-66 Lark, 1963-64 Hawk & 1963-83 Avanti with front disc

G145637 Ball, under bleeder screw. \$1.50 ea.

1557504 Bracket, right caliper mounting. \$78.00 ea.

1557505 Bracket, left caliper mounting. \$78.00 ea.

1557510 Caliper shim .010* \$1.50 ea.

1557511 Caliper shim .013* \$1.50 ea.

1557512 Caliper shim .016* \$1.50 ea.

1557513 Caliper shim .019* \$1.50 ea.

**Note: For proper braking, disc brake calipers must be aligned using shims. Follow instructions in your Studebaker shop manual.*

DISC BRAKE CALIPER REPAIR KIT

1558063 1963-64 Hawk, 1963-66 Lark, 1963-83 Avanti. Seals for 4 calipers. Enough for two wheels. \$68.25 ea.



HAND OR PARKING BRAKE 1950 Car

Models 9G - 17A. Used on cars with Standard & Overdrive.

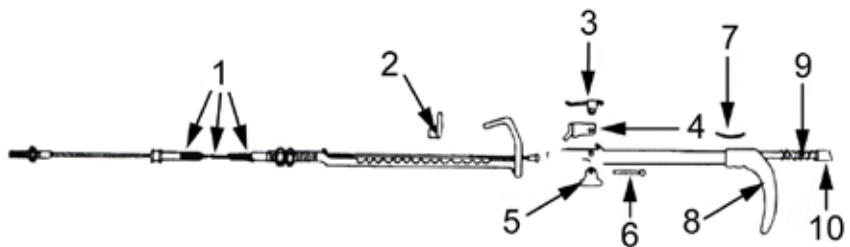

(1) **526387** Front parking brake cable. 1950 Champion \$55.80 ea.

(1) **526388** Front parking brake cable. 1950 Commander & Land Cruiser \$55.80 ea.

(2) **525625** Anti-rattle spring \$3.50 ea.

(3) **525638** Spring, hand brake control plunger pawl. \$4.50 ea.

(4) **527638** Pawl, all \$8.50 ea.

(5) **525639** Stop, all \$2.50 ea.

(6) **525480** Rivet, all \$1.00 ea.

(7) **526995** Spring, anti-rattle \$2.50 ea.

(8) **527011** Handle & plunger \$37.00 ea.

(9) **525633** Spring, release..... \$2.50 ea.

(10) **525630** Rod & button. \$20.00 ea.

801818 Parking brake handle kit. Includes all parts #1-10 for 1950 Champion.

Total of all parts if purchased separately. \$128.00

Special package price \$115.00

801819 Parking brake handle kit. Includes all parts #1-10 for 1950 Commander & Land Cruiser.

Special package price \$115.00

BRAKE BOOSTER / HYDROVAC REPAIR KITS & RELATED PARTS

536985 Hydrovac check valve. 1955-64 car except 1957-58 Golden and Packard Hawk with air conditioning and 1963-64 Hawk with disc brakes.**\$42.00 ea.**

537239 Control valve repair kit. 1955-64 car with Hydrovac. Truck: 3E through 8E models 10, 11, 12, 13, 14, 15.**\$30.00 ea.**

537933 Hydrovac repair kit. 1955-56 cars with model # 377478 Hydrovac.**\$115.00 ea.**

677442 Diaphragm for Hydrovac. 1955-56 car with Hydrovac #377148 or 377478. Limited quantities.**\$48.00 ea.**

677614 Control valve repair kit. All 2R through 8E 16, 17, 28, 35, 38, 40, and 45 except 40 & 45 with heavy duty brakes.**\$26.50 ea.**

679690 Major Midland Hy-Power booster repair kit. 2R 16 & 17 Model trucks equipped with the Midland booster.**\$115.00 ea.**

1541844 Hydrovac repair kit. 1955 cars with model # 377148 Hydrovac.**\$120.00 ea.**

1541845 Booster repair kit. 1959-60 car with booster model #376500. Truck: 3E through 8E 3/4 ton truck.**\$112.50 ea.**

1553343 Booster repair kit. All 1961 Lark & 1962 Lark with type "B" booster. See 1959-64 chassis manual for illustration.**\$115.00 ea.**

1555590 Booster check valve seal. 1963-71 Avanti. 1963-66 Lark with disc brakes.**\$3.50 ea.**

1555595 Booster repair kit. All 1962 Lark & all 1959-64 Lark with type "C" booster. See 1959-64 chassis manual for illustration.**\$115.00 ea.**

1559721 Brake booster check valve. 1963-71 Avanti. 1963-66 Lark with disc brakes. Replacement type.**\$20.00 ea.**

1559735 Booster piston packing kit. All 1963-64 Hawks with disc brakes. Limited supply.**\$78.00 ea.**

1688220 Hydrovac repair kit for 6-3/4" diameter booster. All 2R - 8E 16, 17, 28, 35, 38 trucks with overdrive.**\$115.00 ea.**

1688221 Hydrovac repair kit for 9-1/2" diameter booster. Truck: E & 2E 16, 17, 28, 38, 45 through 8E 16 through 35 with heavy duty brakes and 3E - 8E 17, 38, 40, 45 with standard brakes.**\$115.00 ea.**

1689299 Complete Hydrovac repair kit. Truck: 3E - 6E 1, 2, 3, 5, 6, 7. 7E - 8E 5, 7.**\$105.00 ea.**

1691965 Control valve repair kit. Truck: 4E - 8E models 40 through 45 with heavy duty brakes.**\$60.00 ea.**

1696523 Complete Hydrovac repair kit. Truck: 8E 25, 28, 35.**\$105.00 ea.**

POWER BRAKE BOOSTERS

Rebuilt boosters sold exchange only.
We must have your old core first.
When ordering please specify year & model of car. Send **ONLY** the bare core!
Remove brackets, fittings, etc.
There is an additional charge for disassembling cores.

Note: New boosters do not require a core first but if you should want to sell it, we will pay you \$50 for your rebuildable core.



800490R 1971-85 Avanti. Rebuilt Does not include check valve.**\$359.95 Ex.**

1544394R Hydrovac. 1955-60 car, all models. 1961-64 Hawk with drum brakes. Rebuilt. Does not include check valve.**\$690.00 Ex.**

802100 New manufacture Hydrovac 1955-60 car, all models. 1961-64 Hawk with drum brakes.**\$510.00 ea.**



802101 New manufacture Hydrovac 1963-64 Hawk with front disc.**\$526.00* ea.**

1557903R 1963-66 Lark & 1963-71 Avanti with front disc. Rebuilt. Does not include check valve.**\$365.95 Ex.**



1558380R 1963-64 Hawk with front disc. Rebuilt. Does not include check valve.**\$729.95 Ex.**



1559719 Booster. 1963 Lark with drum brakes. NOS.**\$345.00 ea.**

Note: Brake boosters for 1961-66 Lark. Call for availability & price: 317-462-3124. We need cores for all types of boosters! If you have any extra cores, we are always interested in purchasing them.

BOOSTER SEAL KITS

801123 Power brake booster rebuild seal kit. 1963-66 Lark. 1963-71 Avanti with front disc brakes.**\$170.00/kit**

801851 Seal Kit for Hydrovac, 1955-64 all models.**\$130.00/kit**

HYDROVAC FLEX HOSE

NOTE: These lines connect the front pipes to the Hydrovac and after many years of use acquire a build-up of residue that restricts the flow of fluid. If your brakes are sluggish, you may want to replace these 2 hoses.

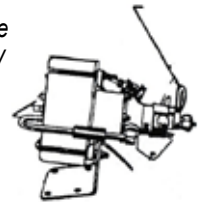

536652 1955-60 car & 1961-64 Hawk, all models with power assist. Truck: late 56-62 1/2 ton 2E, 7E. Takes 2.**\$39.00 ea.**



Takes 2 for front & 1 for rear

FLEXIBLE HOSES

NOTE: Original brake hoses usually look good on the outside but can be brittle and have a build-up of residue inside. The old rubber can also pull off of the metal ends under heavy pressure. Be safe — replace the hoses!

185015 1935-38 Dictator, Commander & President front & rear. Truck: M15-M17 & 2R-8E 13-40 front & rear.**\$40.00 ea.**

195568 1939-41 Commander & President front & rear. 1941 Coupe Express front & rear. 1942 Commander & President rear. Truck: 1941-48 M-5 front & rear.**\$33.75 ea.**

519637 1947-49 car, all models front & rear. 1959-66 car, all models front.**\$33.75 ea.**

523614 1951-58 car, all models front. Truck: 2R-7E 1, 3, 5, 7, 10, 12 front & rear & 8E 5, 7, 10, 12 rear.**\$33.75 ea.**

526184 1939-46 & 1950-52 Champion front & rear. 1950-52 Commander front. Truck: 8E 5, 7, front. 3E-4E w/4WD front.**\$33.75 ea.**

1543003 1950-52 Commander rear. 1953-66 car, all models rear. 1963-85 Avanti, rear. Truck: 8E 10, 12 front.**\$33.75 ea.**

1557543 1963-64 Hawk, 1963-66 Lark, 1963-83 Avanti with front disc brakes. Takes 2.**\$33.75 ea.**

SELF ADJUSTER PARTS 1947-53 1963-66

(For Non-disc brake cars only)

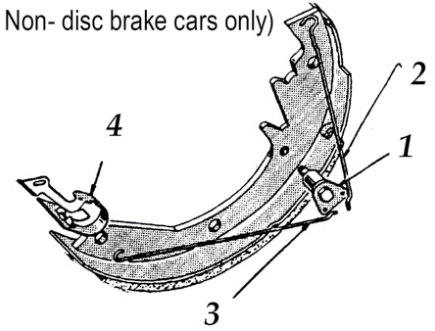
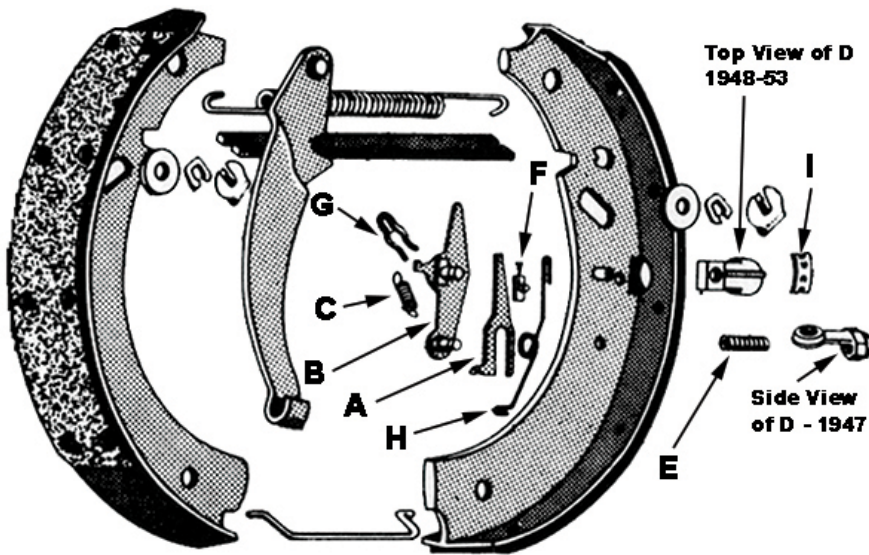

- | | |
|---|---|
| (A) 521391 Right, wedge. All \$9.00 ea. | (G) 521572 Cotter. 1947 only \$1.50 ea. |
| (A) 521392 Left wedge. All \$9.00 ea. | (H) 524028 Right spring. 1948-53..... \$5.50 ea. |
| (B) 521393 Right lever. All \$19.00 ea. | (H) 524029 Left spring, 1948-53 \$5.50 ea. |
| (B) 521394 Left lever. All \$19.00 ea. | (I) 527253 Spring. All \$6.50 ea. |
| (C) 521395 Spring. All..... \$4.00 ea. | 801277 16 piece kit for front or rear. 1947 car only. Takes 2 kits per car \$89.00/kit |
| (D) 521396 Self-adjuster tip. Enough for 2 wheels \$19.25/pr. | 801278 14 piece kit for front or rear, 1948-53 car, all models 1949-53, 1/2 ton truck. Takes 2 kits per car \$84.00/kit |
| (E) 521397 Spring. 1947 only \$3.50 ea. | |
| (F) 521398 Guide. All..... \$6.50 ea. | |

- | |
|--|
| (1) 1558502 Right, screw & lever..... \$9.00 ea. |
| (1) 1558503 Left, screw & lever..... \$9.00 ea. |
| (4) 1558508 Right, adjusting lever... \$19.00 ea. |
| (4) 1558509 Left, adjusting lever. \$19.00 ea. |
| (2) 1558510 Adjusting link anchor, front for 6-cylinder, rear for V-8. \$3.50 ea. |
| (3) 1558511 Adjusting link anchor actuating, front for 6-cylinder, rear for V-8 \$3.50 ea. |
| (2) 1558516 Rear, adjusting link anchor. 6-cylinder \$3.50 ea. |
| (3) 1558517 Rear, adjusting link anchor actuating for 6-cylinder \$3.50 ea. |
| (2) 1558526 Front, adjusting link anchor. V-8...
..... \$3.50 ea. |
| (3) 1558527 Front, adjusting link anchor actuating. V-8..... \$3.50 ea. |

BRAKE HOSE COPPER WASHERS & LOCK CLIPS

185166 Washer, 1935-42 Dictator, Commander, Coupe Express. Truck: M5-M17 & 2R-8E 13-45...
.....**\$1.50 ea.**

195569 Washer, 1939-46 Champion. 1947-66 car, all models. Truck: 2R-8E 1, 2, 3, 5, 6, 7, 10, 11, 12**\$1.50 ea.**

 **675466** Lock clips, brake hose to frame. 1947-66, all.....**\$2.50 ea.**

FIREWALL BOOT

1553241 1961-66 Lark & 1963-85 Avanti.**\$11.50 ea.**



HILL HOLDER VALVE SEAL KITS

526633 1950-66 car, all models, 1963-64 Avanti. Truck: 1941-63 all models. Includes cam, plug, gasket & washer.....**\$27.00 ea.**

526633X1 Same as above except ball cage included**\$100.00 ea.**

801704 Ball only**\$4.95 ea.**

RETURNING PARTS?

Do not forget a copy of your invoice with your return!

There is a **\$5.00** "Invoice Search" fee for items returned without an invoice.



ADJUSTING SCREW, NUT & GUIDE

535164 1954-62 car, all models. Truck: 8E 5, 7.
.....**\$11.00 ea.**



1558504 Right. 1963-66 car, all models. Non-disc brake car only.....**\$16.50 ea.**

1558505 Left. 1963-66 car, all models. Non-disc brake car only.**\$16.50 ea.**

ADJUSTING HOLE PLUG

 **535168** 1954-66 car, all drum brake models. Non-disc brake car only. Takes 4**\$2.50 ea.**

BRAKE LINE JUNCTION BLOCK "T" FITTING

194697 "T" fitting on rear axle. 1939-46 Champion, 1947-66 car & 1963-71 Avanti. Truck: 2R-6E 5, 6, 7, 10, 11, 12 & 3E-6E 1, 3 & 7E-8E 5, 7, 10, 12
.....**\$17.90 ea.**



BRAKE DRUMS

CARS



194525 Right, front drum & hub. 1939-40 Champion.....
.....**\$180.00 ea.**

194526 Left, front drum & hub. 1939-40 Champion.....
.....**\$180.00 ea.**

513147 Right, front drum & hub. 1941-46 Champion.....
.....**\$150.00 ea.**

524164 Front Drum & Hub Late 1948-50 Champions.....
.....**\$224.50 ea.**

529118 Drum & hub, right front. 1951-53 Commander.....
.....**\$250.00 ea.**

529119 Drum & hub, left front. 1951-53 Commander.....
.....**\$250.00 ea.**

530338 Rear Drum & Hub 1947-50 Champion ..
.....**\$195.00 ea.**

535524 Front, drum only. 1954-56 6-cylinder...
.....**\$250.00 ea.**

1539469 Front left. 1956 Champion 6-cylinder. All with left hand thread.....
.....**\$295.00 ea.**

1542151 10" Front left, drum & hub. 1957-58 6 cylinder. All with left hand thread.....
.....**\$295.00 ea.**

1542157 10" Front drum. 1956-62 6 cylinder. Rear drum for 1956-64 V-8.....
.....**\$225.00 ea.**

1557400 Rear drum, 11" finned complete with hub & studs. All 1963-66 Lark and Hawk with front disc. 1963-64 Avanti with tapered axles. Pictured.....
.....**\$250.00 ea.**

1558903 11" Front, drum only with 3/8" diameter mounting hole. 1963-64 V-8.....
.....**\$250.00 ea.**

1558905 10" Rear finned, drum only. 1956-66 V-8 with tapered axle. Includes studs.....
.....**\$195.00 ea.**

1561790 10" Rear, drum only. 1966 6-cylinder & V-8 car with flanged axle. Considered heavy duty on 6-cylinder only.....
.....**\$190.00 ea.**

1562457 Front drum with right-hand thread, 11" finned. Complete with hub & cups. 1956-66 V-8...
.....**\$250.00 ea.**

1697013 Drum only, front and rear. 1940-50 Commander & Land Cruiser. Includes 5 new studs.....
.....**\$225.00 ea.**

TRUCKS

(Note: All are available in extremely limited quantities.)

1686176 Front drum. 1957-64 3E through 8E model 40 with standard front axle. Also fits 1962-64 models 45 with the same equipment. All less air brakes.....
.....**\$278.50 ea.**

1690121 Rear hub & drum for 1957-64 3E through 8E Truck model 40 with heavy duty rear axle and less air brakes. Also fits 1962-64 model 45 with the same equipment.....
.....**\$327.50 ea.**

1691108 Front, drum only. 1962-64 7E & 8E 40 & 45 models with heavy duty front axle and less air brakes. Also having the forging number embossed on the front I-beam itself. Note: This drum is standard equipment for 40E & 45E and optional on 40A & 45A.....
.....**\$327.50 ea.**

1694897 Front (drum only), 1962-64 7E & 8E 40 & 45 models with heavy duty front axle disc. Equipped and with air brakes. Also having the forging number embossed on the front I-Beam itself.....
.....**\$327.50 ea.**

1694984 Front (drum only), 1962-64 7E & 8E 40 & 45 models with heavy duty front axle having Gunite wheels, air brakes, and also having the forging number embossed on the front I-Beam itself.....
.....**\$327.50 ea.**

1694991 Rear (drum only), 1962 7E 40 & 45 models with heavy duty rear axle having Gunite wheels, air brakes, and axle ID plate stamped H-140-PX32 or H-340-PX20.....
.....**\$327.50 ea.**

1697013 drum only, front and rear. 1941-64 1/2 ton truck. Includes 5 new studs.....
.....**\$195.00 ea.**

BRAKE DRUM PULLER



J-1644 Rear brake drum puller for all models with tapered rear axle.....
.....**\$225.00 ea.**

SPRINGS



159238 Shoe return spring. 1931 President.....
.....**\$13.00 ea.**

159239 Shoe return spring. 1931 President.....
.....**\$13.00 ea.**

159243 Shoe return spring. 1931 President.....
.....**\$10.50 ea.**

185480 Shoe return spring. 1935-37 Dictator. 1935-40 President. 1935-40 Commander. Takes 4. Truck: 1941-48 M5 front.....
.....**\$10.00 ea.**

193129 Shoe return spring. 1938-40 Commander & President.....
.....**\$11.50 ea.**

199992 Shoe return spring. 1941-42 Commander & President rear. Truck: 1941-48 M5 rear.....
.....**\$10.00 ea.**

521407 Shoe return spring. 1947-53 Champion front & rear 1951-53 Commander rear.....
.....**\$10.00 ea.**

521567 Shoe return spring. 1947-50 Commander front & rear. 1951-53 Commander front. Truck: 2R-3R 5, 6, 7.....
.....**\$10.00 ea.**

530867 Pedal pull-back spring. 1951-53 car with auto trans.....
.....**\$8.50 ea.**



535157 Anti-rattle spring for rear brake shoe operating link. 1954-66 car, all models. Takes 2 per car.....
.....**\$5.50 ea.**

535160 Shoe return spring. 1954-66 car, all models. Takes 2 per wheel.....
.....**\$4.50 ea.**

535167 Adjusting screw spring. 1954-62 car, all models. Takes 1 per wheel. Truck: 8E 5, 7.....
.....**\$5.00 ea.**

535189 Pedal pull-back spring. 1954-60 car, all models without power assist. 1961-64 Hawk without power assist.....
.....**\$9.00 ea.**

536622 Pedal pull-back spring. 1954-60 car, all models with power assist. 1961-64 Hawk with power assist.....
.....**\$9.00 ea.**

666131 Front shoe return spring. Truck: 2R, 16, 17.....
.....**\$10.00 ea.**

683043 Shoe return spring. Truck: 2E 10, 11, 12 & 3E-6E 13, 14 & 7E-8E 13, 15.....
.....**\$14.00 ea.**



800794 Shoe return spring kit. Truck: late 1956 (2E) through 1962 1/2 ton. Car: 1963-64 Hawk, 1963-66 Lark, 1963 - early 1971 Avanti upper & lower. Enough for 2 wheels. Rear with front disc brakes only.....
.....**\$19.95 kit**

1552044 Pedal return spring. 1961-66 Lark.....
.....**\$13.00 ea.**



1558507 Rear adjusting screw spring. 1963-66 without disc.....
.....**\$8.40 ea.**

www.studebaker-intl.com

(317) 462-3124

SPECIAL DRUM BRAKE REBUILD KITS

for 1947-62 Car &
1963-64 Hawk

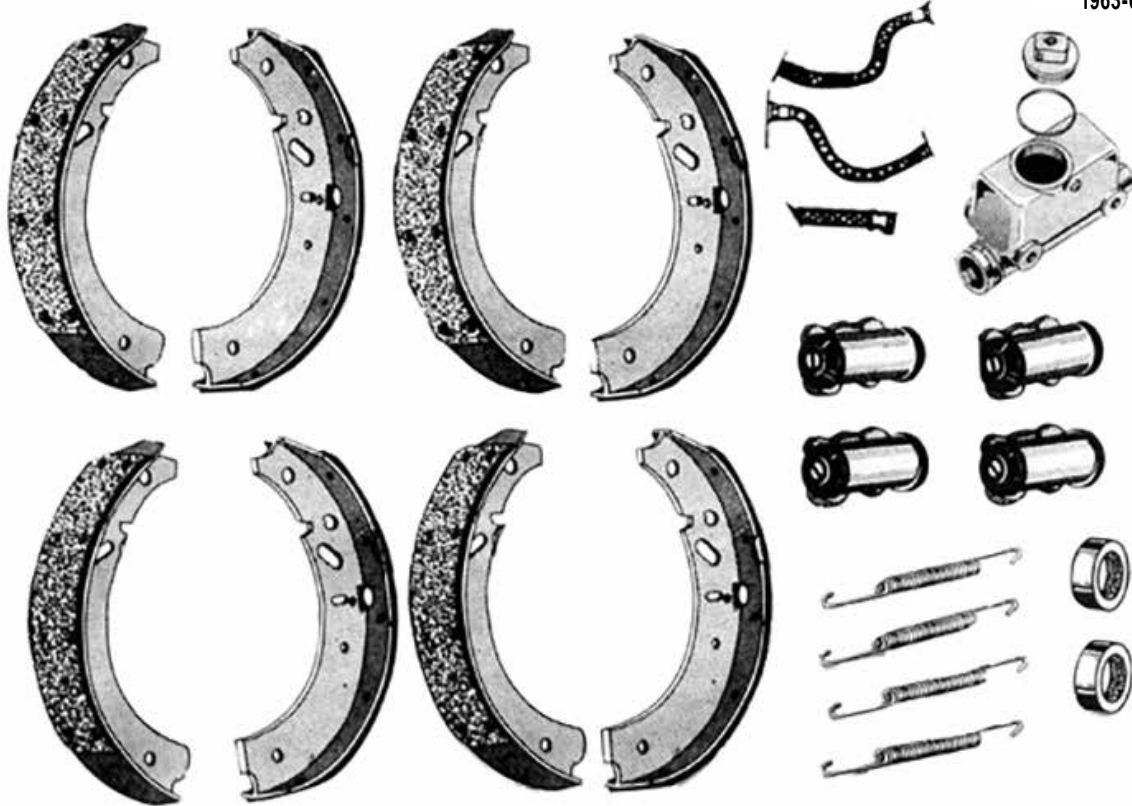

Kit Includes

1947-49 Champion**

Total of all parts if purchased separately \$775.40
801131R Your cost **\$735.00/kit**

1950-53 Champion**

Total of all parts if purchased separately \$798.40
 Special Kit Price \$755.00
 — 10% quantity discount. See page 6.
 \$75.50
801132R Your cost **\$679.50/kit**

1950 Commander**

Total of all parts if purchased separately \$896.90
 Special Kit Price \$850.00
 — 10% quantity discount. See page 6.
 \$85.00
801133R Your cost **\$765.00/kit**

1951-53 Commander**

Total of all parts if purchased separately \$847.90
 Special Kit Price \$805.00
 — 10% quantity discount. See page 6.
 \$80.50
801134R Your cost **\$724.50/kit**

1 Set of relined rear shoes
 Either applies, \$100.00 core charge, mandatory pre-order core send, first, or none of the above. See relined shoes on page 255 for further explanation.

- 1 Set of shoe return springs**
Enough for all 4 wheels
- 1 New master cylinder**
- 2 New front wheel cylinders**
- 2 New rear wheel cylinders**
- 2 Front bearing grease seals**
- 2 Flexible front hoses**
- 1 Flexible rear hose**
- 3 Copper washers**
Flex hose to wheel cylinder

- 4 Adjusting hole plugs**
1954 & Later only
- 2 Pr. Self-adjuster tips**
1947-53 only

1 Set relined front shoes
 Either applies, \$100.00 core charge, mandatory pre-order core send, first, or none of the above. See relined shoes on page 255 for further explanation.

****Note: All 1947-53 Cars require you to send your old shoes to us first**

*** These kits come with new shoes and do not require a core charge or your old shoes to be returned first.**

Please note: We reserve the right to change core charges and pre-send policies according to the availability of usable shoes to reline.

1954-60 6 Cyl. Car

All Models

Total of all parts if purchased separately \$606.60
801035R Your cost **\$575.00/kit**

1954-60 V-8 Car*

All Models & 1961-64 Hawk

Total of all parts if purchased separately \$676.60
801036R Your cost **\$640.00/kit**

1961-62 Lark 6-Cyl.

Without Power Assist

Total of all parts if purchased separately \$699.00
801037R Your cost **\$660.00/kit**

1961-62 Lark V-8 *

Without Power Assist

Total of all parts if purchased separately \$769.00
801038R Your cost **\$730.00/kit**

NOTE: When ordering specify year and model of car. No substitutions or deletions. Core charges are not discountable. Invoice must be included with core for refund.

DISC BRAKE ROTOR



1557500 Disc brake rotor 1963-66 all models & 1963-83 Avanti with front disc brakes including Avanti. Includes rotor, hub, stud and cups. Assembled and ready to install.**\$225.00 ea.**

MAJOR DISC BRAKE REBUILD KITS

with Rotors

Kit Includes

- 1 new master cylinder
- 4 new front calipers
- 2 front crossover pipes
- 2 front hose to caliper pipes
- 2 front flexible hoses
- 1 rear flexible hose
- 1 copper washer
- 1 set front pads
- 1 set rear shoes (relined)
- (Refundable \$100.00 core charge applies)
- 4 rear shoe return springs (Except late 1971-83 Avanti)
- 2 rear wheel cylinders
- 2 front rotors
- 2 front grease seals
- 2 outer wheel bearings
- 2 inner wheel bearings
- 2 dust caps

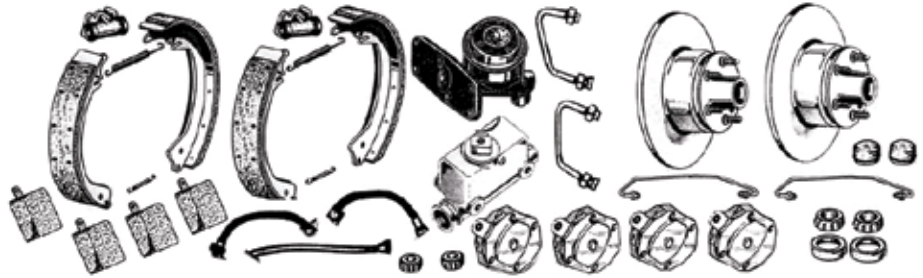

FRONT DISC BRAKE PADS



1558066 1963-64 Hawk, 1963-66 Lark, 1963-83 Avanti.**\$47.90 set/4**

SHOE ADJUSTMENT ECCENTRIC

(Including Nut)



800908 Cars; 1963-64 Hawk, 1963-66 Lark, 1963-early 1971 Avanti, all with front disc brakes.

Truck; late 56-62 1/2 ton. (Disc Brake Cars - Takes 4. Trucks take 8)**\$29.00 ea.**

DISC BRAKE PIPES

1557546 Front hose to caliper. Right. 1963-64 Hawk, 1963-66 Lark, 1963-83 Avanti**\$24.00 ea.**



1557547 Front hose to caliper. Left. 1963-83 Avanti, 1963-64 Hawk, 1963-66 Lark**\$24.00 ea.**

1558068 Crossover pipe. Right. 1963-64 Hawk, 1963-66 Lark, 1963-83 Avanti**\$26.50 ea.**

1558069 Crossover pipe. Left. 1963-64 Hawk, 1963-66 Lark, 1963-83 Avanti.**\$26.50 ea.**

PIPE SPACER & CLIPS

194702 Clip, brake pipe to frame. 1939-66 most models.**\$4.00 ea.**



530186 Clip, brake pipe to rear differential**\$4.70 ea.**



531013 Spacer, brake pipe to rear-end cover**\$1.95 ea.**



<p>1963-64 Hawk</p> <p>Total of all parts if purchased separately \$1,809.15</p> <p>Special Kit Price \$1,715.00</p> <p>— 15% quantity discount. See page 6. \$257.25</p> <p>801559R Your cost \$1,457.75/kit</p>	<p>1966-early 1971 Avanti</p> <p>Total of all parts if purchased separately \$1,859.85</p> <p>Special Kit Price \$1,765.00</p> <p>— 15% quantity discount. See page 6. \$264.75</p> <p>801560R Your cost \$1,500.25/kit</p>
<p>1963-66 Lark & 1963-64 Avanti</p> <p>Total of all parts if purchased separately \$1,876.65</p> <p>Special Kit Price \$1,780.00</p> <p>— 15% quantity discount. See page 6. \$267.00</p> <p>801558R Your cost \$1,513.00/kit</p>	<p>Late 1971-83 Avanti</p> <p>Total of all parts if purchased separately \$1,676.10</p> <p>Special Kit Price \$1,590.00</p> <p>— 15% quantity discount. See page 6. \$238.50</p> <p>801561R Your cost \$1,351.50/kit</p>

***NOTE: Price does not include core charges. When ordering specify year and model of car.**

No Substitutions or deletions. Core charges are not discountable. Invoice must be included with core for refund.

NEW WHEEL CYLINDERS

197118 1", front. 1939-49 Champion. \$94.50 pr.	535585 1-1/16" front. Car: 1954-66 V-8. \$91.00 pr.
197120 7/8", rear. 1939-53 Champion & 1951-53 Commander. \$130.00 pr.	535586 7/8" rear. Car: 1954-66 V-8. Truck: 8E 5, 7. \$90.00 pr.
521570 7/8" rear. 1947-50 Commander. Truck: 2R-2E 5, 6, 7, 3E-6E 1, 2, 3, 5, 6, 7 & 7E 5, 7 with self centering type \$179.00 pr.	681068 Rear. Truck: 2R 14-17 & 3R-E 16, 17, 28, 38 & 3E-6E 16, 28 & 7E-8E 25, 28, 35. Takes 4. All with heavy duty brakes, takes 2 per wheel. \$182.00 pr.
525208 1", front. 1950-53 Champion. \$129.00 pr.	683448-9 Right and left, rear. Truck: 3R-8E 13, 14, 15 \$144.50 pr.
525821 1" front. 1950-53 Commander. Truck: 2R-2E 5, 6, 7 & 3R-2E 10, 11 with self-energizing. \$178.50 pr.	683450-1 Right and left, front. Truck: 3R-8E 13, 14, 15 \$136.50 pr.
535583 1" front. Car: 1954-66 6-cylinder. Truck: 8E 5, 7 \$91.00 pr.	684606-7 1" right and left, front. Truck: 3E-6E 1, 2, 3, 5, 6, 7 & 7E 5, 7. \$136.50 pr.
535584 13/16" rear. Car: 1954-66 6-cylinder. \$91.00 pr.	

SPECIAL DISC BRAKE REBUILD KITS

Kit Includes

- 1 new master cylinder
- 4 new front calipers
- 2 front crossover pipes
- 2 front hose to caliper pipes
- 2 front flexible hoses
- 1 rear flexible hose
- 1 copper washer
- 2 front bearing grease seals
- 1 set front pads
- 1 set rear shoes (relined) (Refundable \$100.00 core charge applies)
- 4 rear shoe return springs (Except late 1971-83 Avanti)
- 2 rear wheel cylinder

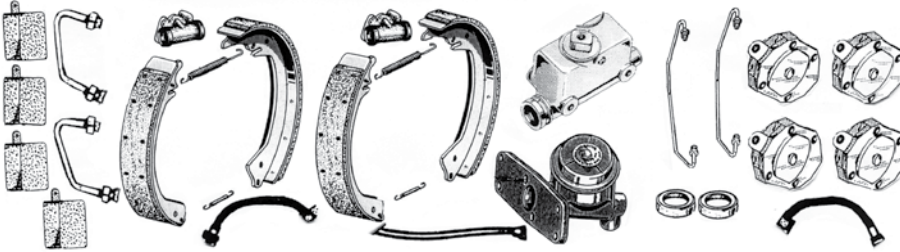

<p>1963-64 Hawk</p> <p>Total of all parts if purchased separately\$1,279.15</p> <p>Special Kit Price\$1,215.00</p> <p>— 10% quantity discount. See page 6.\$121.50</p> <p>801040R Your cost \$1,093.50/kit</p>	<p>1966 (with Dual Master Cylinder) -early 1971 Avanti</p> <p>Total of all parts if purchased separately\$1,329.85</p> <p>Special Kit Price\$1,260.00</p> <p>— 10% quantity discount. See page 6.\$126.00</p> <p>801063R Your cost \$1,134.00/kit</p>
<p>1963-66 Lark & 1963-64 Avanti</p> <p>Total of all parts if purchased separately\$1,346.65</p> <p>Special Kit Price\$1,275.00</p> <p>— 10% quantity discount. See page 6.\$127.50</p> <p>801039R Your cost \$1,147.50/kit</p>	<p>Late 1971-83 Avanti</p> <p>Total of all parts if purchased separately\$1,180.70</p> <p>Special Kit Price\$1,120.00</p> <p>— 10% quantity discount. See page 6.\$112.00</p> <p>801064R Your cost \$1,008.00/kit</p>

***NOTE: Price does not include core charges. When ordering specify year and model of car.**

No Substitutions or deletions. Core charges are not discountable. Invoice must be included with core for refund.

WHEELS FOR TRUCKS



- 800340-1** Right and left, rear. Late 1971-85 Avanti..... **\$45.00 pr.**
- 1557668** 3/4" rear. 1963-64 Hawk, 1963-66 Lark, 1963-71 Avanti with front disc brakes. **\$179.00 pr.**
- 1687216-7** 1-1/2" right and left, rear. Truck: Late 2E & 3E-8E 10, 11, 12..... **\$89.00 pr.**

WHEEL CYLINDER PUSH ROD



- 1552728** 1954-66, all models **\$5.40 ea.**

WHEEL CYLINDER REPAIR KITS



- S-374** Front. 1939-53 Champion & 1947-53 Commander. Truck: 2R-2E 5, 6, 7, 10, 11, 12 & 3E-7E 1, 2, 3, 5, 6, 7 **\$9.45 ea.**
- S-375** Rear. 1939-53 Champion & 1947-53 Commander. Truck: 2R-2E 5, 6, 7 & 3E-7E 1, 2, 3, 5, 6, 7. **\$11.00 ea.**
- S-376** Front. 1935-42 Dictator, Commander, President & 1937-39 Coupe Express. Truck: M5. **\$16.00 ea.**
- S-377** Rear. 1935-42 Dictator, Commander, President & 1937-39 Coupe Express. Truck: M5 .. **\$16.00 ea.**
- S-387** Front. Truck: M15, 15A, 16, 17 & 2R 14, 15 & 3R-8E 16, 17, 25, 28, 35, 38. **\$24.15 ea.**
- S-388** Rear. Truck: M15, 15A, 16, 17 & 2R 14, 15, 16, 17 except heavy duty **\$28.10 ea.**
- 535556** Front. 1954-66 6-cylinder car. Truck: 8E 5, 7..... **\$8.75 ea.**
- 535557** Rear. 1954-66 6-cylinder car. **\$16.80 ea.**
- 535558** Front. 1954-66 V-8 car..... **\$8.75 ea.**
- 535559** Rear. 1954-66 V-8 car. Truck: 8E 5, 7. **\$8.75 ea.**
- 643158** Spring rear wheel cylinder. Truck: 3-R-8E, 13, 14, 15..... **\$4.25 ea.**
- 679048** Rear. Truck: 2R-2E 10, 11, 12 & 3E-6E 2, 3, 6, 7 with 4WD & late 7E 5, 7..... **\$11.25 ea.**
- 681093** Rear. Truck: 2R 14-17 & 3R-8E 16, 17, 25, 28, 35, 38 rebuild kit for 681068 wheel cylinder **\$19.60 ea.**
- 683452** Front. Truck: 3R-8E 13, 14, 15 & 3E-4E 11, 12 with 4WD. **\$11.60 ea.**
- 683453** Rear. Truck: 3R-8E 13, 14, 15..... **\$14.25 ea.**
- 800342** Rear. Late 1971-85 Avanti with front disc brakes..... **\$10.50 ea.**
- 1557671** Rear. 1963-64 Hawk, 1963-66 Lark, 1963-71 Avanti with front disc brakes .. **\$11.50 ea.**
- 1688284** Front. Truck: Late 2E & 3E-8E 10, 11, 12..... **\$15.75 ea.**
- 1693964** Rear. Truck: 3E-8E 10, 11, 12..... **\$11.60 ea.**

KITS are a
great way to
to Save
MONEY!

RELINED BRAKE SHOES

513421** 1939-46 Champion front or rear
..... **\$139.00 set**

800179** 1947-50 Commander front or rear
& 1951-53 Commander front. Truck: 2R-E 5, 6, 7
front or rear..... **\$136.90 set**

****800180** 1947-53 Champion front or rear &
1951-53 Commander rear..... **\$136.90 set**

****800182** 1954-66 6 cyl rear all models.
..... **\$136.90 set**

800317** 1941-42 Commander front or rear.
Truck: 1941-48 M5 front & rear **\$138.75 set**

800343* Late 1971-83 Avanti, rear **\$155.00 set**

Please note: We reserve the right to change core charges and pre-send policies according to the availability of shoes to reline.

801826** Truck: 2E-8E 10, 11 12 front and
rear. 2E-8E 13,14, 15 Front only..... **\$157.50 set**

**Note: A refundable core charge of \$100.00 applies to remanufactured brake shoe sets. (Except 1560103 - since they're new) Invoice must be included with core for refund. Brake shoes come in sets. One set is enough to replace all of the shoes on either the two front or two rear wheels.*

***Note: Core shortage requires your old shoes be received prior to order being sent.*

Also note: We have assorted linings, lining sets, & single shoes available - Please inquire.

SHOE RETAINERS

185483 Brake shoe retainer. 1934-49 car, 1937-
39 Coupe Express, 1941-48 M5 truck and early
2R5 - 2R10 truck..... **\$1.50 ea.**

526531* Clip. 1950-51 car, all.
Truck: Late 2R 5 & 6 through early
2E 5-6-7, late 2R10 -11 through early
2E 10-11-12. Front only. **\$5.50 ea.**



535147 Anchor plate. 1954-
66, all models **\$5.50 ea.**



535158* Guide pin.
1954-66 car, all models
Truck: 8E 5, 7... **\$2.35 ea.**



535159* Retainer clip. 1954-
66 car, all models. Truck: 8E 5, 7
..... **\$3.00 ea.**



642522 "C" clip. 1952-53 Champion &
Commander..... **\$2.10 ea.**



684771 Rear retainer all cars
with front disc including 1963
Avanti-1971. Truck: Late 2E-7E...
..... **\$5.00 ea.**



1559730 Shoe centering block. 1954-
66, all models **\$8.00 ea.**



NEW BRAKE SHOES

No Cores required.



1557672 1963-64 Hawk, 1963-66 Lark,
1963-early 71 Avanti, rear with front disc. Truck:
E-2E 5, 6, 7 & 3E-7E 1, 2, 3, 5, 6, 7 front & rear ...
..... **\$74.55 set**

1560103X1 1954-66 V-8 car, all models front.
Truck: 8E 5, 7 front & rear..... **\$128.00 set**

1560104 1954-66 V-8 car, all models rear &
1954-66 6 cyl. car front..... **\$68.00 set**

NEW MASTER CYLINDERS



196788 1939-46
Champion.....

..... **\$191.65 ea.**

198526 1935-
1940 Commander
..... **\$203.50 ea.**

199235 1941-42
Commander &

President. Truck: 2R-7E 10, 11, 12..... **\$378.00 ea.**

531510 1947-60 car, all models. 1961-64 Hawk.
Truck: 2R-3R 5, 6, 7 & E-6E 1, 2, 3, 5, 6, 7 & 7E 5,
7..... **\$89.95 ea.**

644751 Truck: M15, 15A, 16, 17..... **\$270.00 ea.**

681832 Truck: E-6E 17, 38, 40 & 4E-8E 16, 25,
28, 35..... **\$300.00 ea.**

800277 1966-early 1971 Avanti w/front disc.
..... **\$166.70 ea.**

800278 Late 1971-85 Avanti with front disc.
..... **\$168.00 ea.**

1552096 1961-62 Lark. 1963-64 Lark without
split system. **\$194.25 ea.**

1557910 1963-66 Lark & 1963-64 Avanti with
front disc..... **\$183.50 ea.**

1558124 1963-64 Hawk with front disc. Cap
not included. **\$116.00 ea.**

1559771 1963 Lark without power brakes. With
split system. Replacement **\$335.00 ea.**

1561611 1964-66 Lark without power brakes &
with split system. Replacement..... **\$135.95 ea.**

1696852 Truck: 8E 5, 7 **\$124.00 ea.**

1696855 Truck: 8E 10, 12..... **\$151.00 ea.**

MASTER CYLINDER FITTINGS & SCREWS

189696 Fitting screw. Rear of mas-
ter cylinder. All models 1953 and later with 531510
master cylinder. Used **\$20.00 ea.**



195470 Master cylinder rear
"Y" fitting. 1941-48 M-5, all 1949-
56 truck. 1939-64 cars with under
floor master cylinder and without
hill holder **\$16.50 ea.**

512770 Master cylinder rear fitting. Most
models with 531510 master cylinder, one pipe
connection. Used..... **\$23.00 ea.**



MASTER CYLINDER FILLER PLUG & GASKET



196562 Gasket only, master
cylinder filler plug. 1940-60
car, all models & 1961-64 Hawk. Truck: M5 & 2R-
8E 1-7, 10-45 **\$2.60 ea.**

1559712 gasket, master cylinder lid. 1963-66
Lark with dual master cylinders **\$7.25 ea.**

1561094 Same as 196562 but with copper.
Original equipment on 1963-64 Hawk with disc
brakes and will fit all models listed..... **\$4.25 ea.**



MASTER CYLINDER TRANSMISSION HOLE COVER

284299 Metal cover. Same application as
below. **\$10.00 ea.**

292050 Rubber Auto Trans filler cover, 1950-55
most models. Master cylinder cover. 1953-60 car,
all models & 1961-64 Hawk, black rubber
..... **\$19.50 ea.**

MASTER CYLINDER REPAIR KITS



S-378 1939-46 Champion **\$29.60 ea.**

S-379 1935-37 Dictator, 1934-42 Commander &
1935-42 President. Truck: M5 & 2R-6E, 10, 11, 12
& 7E: 10, 12. & 3E-4E 2, 3, 6, 7 with 4WD.....
..... **\$78.00 ea.**

S-381 Truck: M15-17 & 2R-6E 13, 14, 16, 17,
28, 38 & 7E 10, 12 with Hydrovac. **\$48.10 ea.**

523918 1947-60 car, all models. 1961-64 Hawk.
Truck: 2R-2E: 5, 6, 7 & 3E-7E: 1, 2, 3, 5, 6, 7
..... **\$29.60 ea.**

1553411 1961-62 Lark (without power assist)..
..... **\$35.70 ea.**

1558126 1963-64 Hawk with front disc.....
..... **\$29.60 ea.**

1558183 1963-66 Lark & 1963-64 Avanti with
front disc..... **\$33.55 ea.**

1686958 Truck: E-6E 17, 38, 40, 45 & 4E-8E
16, 25, 28, 35 with Hydrovac..... **\$60.15 ea.**

1696854 Truck: 8E: 5, 7 **\$24.70 ea.**

1696856 Truck: 8E: 10, 12..... **\$38.85 ea.**



*Jerry Morris's
1963 GT Hawk*



SUSPENSION, STEERING DRIVE-LINE & DIFFERENTIAL SECTION GLOSSARY

Steering Related Parts	257-259	Leaf Springs & Related Parts	267-268
Pitman Arms, Bellcranks & Related Parts	260	A-Arm Bushings, Pins & Bumpers	269-270
Reach Rods, Drag Links, or Reach Rod Ends.....	260	King Pins & Related Parts	271
Tie Rods & Related Parts	261, 276-277	Steering Gear Related Parts.....	272-275
Stabilizer Bars & Related Parts.....	262	Drive Shaft Center Support Related Parts	278
Rear Axle Related Parts.....	263, 284-285	Front Axle Related Parts	279-283
Front Wheel Bearings & Related Parts	264	"Dana" Rear Axle Related Parts	284-285, 287
Shock Absorbers & Related Parts	265	"Twin Traction" Axle Related Parts.....	286
Drive Shaft, Differential & Pinion Bearings.....	266		

REBUILT POWER STEERING PUMP



1558689 Eaton pump without reservoir. 1958-64 car all models including 1963-64 Avanti. **\$218.00 ex.**

NOTE: This is an exchange. We must have your old, rebuildable, pump before your new pump will ship. Please send bare pump only. No brackets or tank. There will be an additional charge if disassembly is required.



RUBBER BUSHINGS

1546133 Rubber bushing ram to bracket. 1958-66 car, all models & 1963-85 Avanti. Eaton/Bendix. Takes 2 **\$4.25 ea.**

PUMP MOUNTING BOLTS



1547363 1963-64 Avanti & 1958-64 car, all models except 1958 Packard Hawk and 1959 V-8 Hawk **\$22.00 ea.**



1547364 1963-64 Avanti & 1958-64 car, all models except 1958 Packard Hawk and 1959 V-8 Hawk **\$22.00 ea.**

PUMP FRONT SHAFT SEALS

535527 1954-56 car, all models. C-R 5681410 type "A" pump. Saginaw **\$12.00 ea.**

1541300 1955-57 cars without a/c, type "B" or "C" pump. Saginaw **\$19.00 ea.**

1543842 1957-58 cars with a/c, type "E" pump. Saginaw **\$18.00 ea.**

1558693 1959-60 V-8. 1961-64 all models & 1963-64 Avanti. Eaton/ Bendix **\$7.05 ea.**



POWER STEERING HOSES

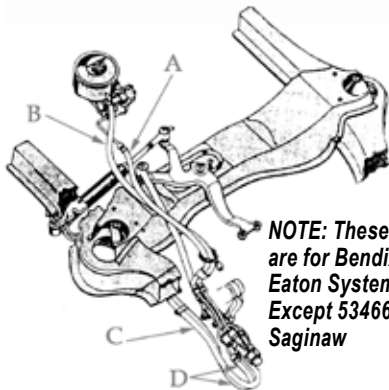

NOTE: These Hoses are for Bendix or Eaton Systems only. Except 534666 is Saginaw

(A) PRESSURE HOSES

534666 1953-54 Champion & Commander All except C & K. Saginaw **\$109.95 ea.**

1547339 1959-63 Lark & Hawk **\$77.70 ea.**

1561481 1964 all models & 1963-64 Avanti **\$70.30 ea.**

1563475 1965-66 V-8 all models & 1966-83 Avanti **\$66.60 ea.**

(B) RETURN HOSES

1544047 1959-63 Lark & Hawk **\$58.80 ea.**

1544050 1958 Champion **\$27.00 ea.**

1559778 1964-66 Lark & 1963-85 Avanti **\$61.05 ea.**

(C) RIGHT TURN HOSES

1544020 1958-60 Hawk **\$66.60 ea.**

1544054 1958-60 Sedan includes Lark **\$71.00 ea.**

1551342 1961-63 Hawk **\$66.60 ea.**

1561482 1961-66 Lark & 1963-85 Avanti **\$66.60 ea.**

1561483 1964 Hawk **\$79.80 ea.**

(D) LEFT TURN HOSES

1544021 1958-60 Hawk **\$66.60 ea.**

1544051 1958-60 Sedan includes Lark **\$66.60 ea.**

1551343 1961-63 Hawk **\$66.60 ea.**

1561484 1961-66 Lark & 1963-85 Avanti **\$66.60 ea.**

1561485 1964 Hawk **\$66.60 ea.**

NOTE: NOTE OF THESE HOSES WILL FIT 1958 PACKARD CAR OR 1959 V-8 HAWK.

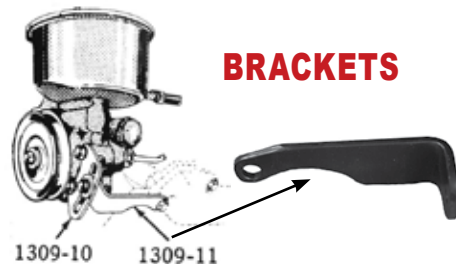

BRACKETS

1549567P Bracket illustrated above, power steering brace. 1958-64 Sedan, 1960-64 Hawk & 1963-64 Avanti. Eaton/Bendix. (1309-10) **\$26.00 ea.**

1549568P Bracket illustrated on right and pictured, power steering brace. 1958-64 Sedan, 1960-64 Hawk & 1963-64 Avanti. Eaton/Bendix. (1309-11) **\$26.00 ea.**

POWER STEERING PARTS & SEAL KITS



534712 Pump seal kit. 1955 all models and 1956 with type "A" pump. Saginaw **\$32.00 ea.**

535512 Pump repair kit, Saginaw. 1955-56 with type "A" or "B" pump. Includes bearing ring & rotor vane kit. **\$178.25 ea.**

801352 Control valve seal kit for Saginaw control valve in all 1953-57 car, 1958 Packard Hawk & 1959 V8 Hawk. Includes all seals for rebuild including seals only on factory seal kit 534665, 534641 power cylinder oil seal, 534655 top cover seal, & 534604 shaft and worm seal. Takes 2 **\$99.95 ea.**

1541294 Gasket set for Saginaw power steering pump, 1956 & 1957 car with type "B" power steering pump **\$45.00 ea.**

1543105 Gasket set for Saginaw power steering pump for 1957-58 car with type "C" or type "D" power steering pump **\$22.00 ea.**

1543843 Pump repair kit, Saginaw, all 1957 cars with AC & early 1958 **\$168.00 ea.**

1543844 Gasket set for Saginaw pump, 1957-58 car with AC & early 1958 car **\$26.00 ea.**

1543903 Seal. Control valve to Pitman arm. 1958-66 all models & 1963-85 Avanti. Eaton/ Bendix **\$2.00 ea.**

1545332 Control valve seal kit. 1958-66 & 1963-85 Avanti. The control valve connects under the steering Pitman arm. It has 2 hoses going to the pump, and 2 going to the ram. Eaton/ Bendix. **\$20.35 ea.**

1553298 Late 1961-64 V8 cars with Type A pump power steering pump reservoir lid seal **\$6.00 ea.**

1553403 Ram seal kit. 1958-66 car & 1963-85 Avanti. The ram looks like a shock absorber turned sideways & fits underneath on the front of the car. It is mounted on the left side of the frame & connects to the center steering bell crank. Eaton/ Bendix **\$26.25 ea.**



1558689X1 Pump seal rebuild kit. Eaton/Bendix. 1958-64 car & 1963-64 Avanti **\$22.20 ea.**

***NOTE: TO DETERMINE THE TYPE PUMP YOU HAVE - EITHER "A", "B", "C", "D" - REFER TO THE FACTORY CHASSIS MANUAL FOR YOUR CAR.**

POWER STEERING REPAIR KITS

- 1 Pump Seal Kit, Except 1965-66 Lark Or 1966-85 Avanti Power Steering Repair Kits
- 1 Control Valve Seal Kit
- Control Valve Ballstud Seats
- 1 Ram Seal Kit
- 1 Pressure Hose
- 1 Return Hose
- 1 Right Turn Hose
- 1 Left Turn Hose

NOTE: When Ordering Specify Year And Model Of Car. No Substitutions Ore Deletions. All Kits Are Bendix/Eaton.

1959-60 Lark
 Total of all parts if purchased separately\$384.55
801044R
 Special Package Price\$365.00 ea.

1962-63 Hawk
 Total of all parts if purchased separately\$384.55
801047R
 Special Package Price\$365.00 ea.

1965-66 Lark & 1966-83 Avanti
 Total of all parts if purchased separately\$353.50
801077R
 Special Package Price\$335.00 ea.

1960-61 Hawk
 Total of all parts if purchased separately\$384.55
801045R
 Special Package Price\$365.00 ea.

1964 Hawk
 Total of all parts if purchased separately\$392.60
801048R
 Special Package Price\$370.00 ea.

1984-85 Avanti
 Total of all parts if purchased separately\$361.90
801078R
 Special Package Price\$340.00 ea.

1961-63 Lark
 Total of all parts if purchased separately\$384.55
801046R
 Special Package Price\$365.00 ea.

1964 Lark & 1963-64 Avanti
 Total of all parts if purchased separately\$379.40
801049R
 Special Package Price\$360.00 ea.

STEERING WHEEL
1551067 Black. 1957-60 car. Truck: 4 & 5 speed 1960-64 Champ\$360.00 ea.



155157
 Black. 1962-64 Hawk. Truck: 1962-64 Champ except 4 & 5 speed\$360.00 ea.

CONTROL VALVE SEALS



For 1953-57 all, 1958 Packard & 1959 Hawk with Saginaw.

- 534616** Sector shaft seal. Pictured, above - left.\$6.00 ea.
- 534641** Oil seal, power cylinder rod.\$16.00 ea.
- 534655** Oil seal, control valve top cover. Pictured, above - right.\$13.00 ea.

STEERING IDLER ARMS & BUSHINGS



- 191833** All 1938 cars & early 1939 Commander\$32.00 ea.
- 196593** Late 1939 Commander & all 1939 Coupe Express. Pictured, above... ..\$28.00 ea.
- 197650** 1939-early 1940 Champion..\$24.00 ea.
- 197918** All 1940 Commander & President.\$28.00 ea.
- 198074** Late 1940 Champion\$32.00 ea.
- 513502** 1939-40 Champion using type "A" mounting bracket. See page 412 in 1934-46 Chassis Parts book. Also late 1941-46 Champion\$22.00 ea.
- 513508** Late 1941 & all 1942 Commander & President.\$24.00 ea.
- 513519** Early 1941 Commander & President.\$22.00 ea.
- 801259R** Pin & bushing kit for idler arm on 1938-46 cars. State year, model and serial # when ordering.\$38.00 ea.
- 1696946** Bushing, idler arm. Truck: 8E 5, 7, 10, 12.....\$22.00 ea.

QUICK STEERING ARM



800355
 Standard on 1985 Avanti. This quick steering arm will work on all 1951-66 Studebaker cars including Lark & Hawk and all 1963 - 85 Avanti. Easily installed, reduces steering time. Recommended for power steering equipped cars only.....\$125.00 pr.

STEERING WHEEL INSERT



1556051 Plastic steering wheel insert 1963-70 Avanti. Takes 2\$12.00 ea.

AVANTI STEERING POST FASTENER



1350271 Adheres to steering post collar & seal to firewall. Takes 3.....\$4.50 ea.

STEERING COLUMN LOWER BUSHING



1559515 1963-early Avanti II without adjustable column.....\$26.50 ea.

NOS STEERING WHEELS

We have a limited stock of new steering wheels for 1957-66 cars. Please inquire at (317) 462-3124

STEERING COLUMN SEALS



291068
1950 Champion.
.....\$65.00 ea.

284956
1947-49 Champion.
Pictured right.
\$65.00 ea.



293087
1951-52 Champion
& Commander.
.....\$75.00 ea.



306906
1954-57 Sedan
without power
steering.
...\$85.00 ea.



306912X1
1954-59 C & K
including Hawk,
with Saginaw power
steering.
.....\$95.00 ea.



1320181X1
1953-57 C & K,
including Hawk.
1958-64 Hawk, all
models.
.....\$90.00 ea.

1324127
1957- 64 Hawk.
Fits below seals
1320181X1 &
306912X1.
.....\$37.95 ea.



**1332466 &
1332478**
1959- 60 Lark.
.....\$24.95 set



1350434
1963- early Avanti II.
.....\$4.50 ea.



**1339323 &
1339390**
1961-66 Lark.
.....\$36.00 set

1350435
1963-early
Avanti II.
.....\$4.50 ea.

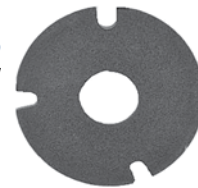

**1656311 &
1656308**
1963-64 Champ.
.....\$34.95 set



**1655229 &
1655226**
1960 Champ.
.....\$24.95 set



252643
31-33 Studebaker
37 Coupe
Express 36-37
President 32-33
Rockne 34-37
Dictator 41-59
Truck all with
FloorShifter.
\$18.00 ea.



649092
1941-1959 truck
steering column
seal w/Column
shift.
\$18.00 ea.



1655725 & 1655722
1961- 62 Champ
.....\$24.95 set

STEERING POST & CAM PARTS



G145641 1934-64 all models with
"TA," "TL," or "SL" steering gear box.
Truck: 1942-56 M5-M17 & 2R5-2E2
with T12, TA12, T14, TA14.....
.....\$6.25 set/25

801551 Stud, Cam lever
shaft 1963-71 Avanti, Truck: 8E
5,7,10,12.....**\$49.95 ea.**



1696791 Steering gear post & cam less bear-
ings & cups. Truck: 8E 5, 7, 10, 12 (Gear SE 54)..
.....\$160.00 ea.

STEERING WHEEL PULLER



J-5473 Heavy duty tool to easily remove your
steering wheel from the steering shaft.....
.....\$17.50 ea.

STEERING BOX GREASE

801651 Semi- Fluid Steering Box
Grease is an ultra tough, aluminum
complex grease designed to lubricate
manual Ross TA/TL (4-bolt side cover)
steering boxes**\$30.85 ea.**



*Note: One 12 oz. Bottle is gene-
rally enough to fill an empty
steering box. It may also be
used to top off a partially filled
box.*

STEERING BOX SEALS



190276 Sector shaft seal.
1957-64 car with type "SL"
box & 1963-75 Avanti. Truck:
2R-6E, 13-17, 28,38, 40 with
TA14 & TA54, 7E-8E all with TA14, TA54.....
.....\$17.50 ea.

530916 Side cover gasket. 1951-60 with "TL"
type box.....**\$4.50 ea.**

679257 Shaft seal. 1951-60 car with type "TA"
or "TL" box. Truck: 2R-3E: 5, 6, 7, 10, 11, 12 & 3E-
4E 1-12 with TA 12.....**\$12.60 ea.**

1542670 Steering box cover seal. Type SL
1957 - 1964 Hawk.....**\$4.95 ea.**

1552088 Shaft seal. 1961-64 car with "S" type
box.....**\$11.25 ea.**

1557623 Housing cover gasket. 1963-75 Avanti
.....**\$4.00 ea.**

PITMAN ARMS



- 532561** 1953-54 C & K without power steering**\$41.50 ea.**
- 665015** Truck: M15-M17. Pictured.....**\$31.25 ea.**
- 679258** 2R-4E 5, 10, TA 12.....**\$42.35 ea.**
- 679274** 3R-7E, 13, 14, 15. TA14.....**\$52.80 ea.**
- 1553208** 1961-66 6-cylinder with SL box & 1961-66 V-8.....**\$42.35 ea.**
- 1553480** 1961-66 Lark with power steering**\$48.00 ea.**

BELLCRANK REBUILT

- 800536** Rebuilt bellcrank. 1951-66 car all models & 1967-85 Avanti. Completely assembled with new pin & bearings. Superior bearings replace original bushings on some models.**\$125.00 ex.**
- Plus \$150.00 Refundable core charge****\$150.00 ea.**
- G271288** Extra long zerck fitting for 800536 bellcrank**\$3.50 ea.**



CENTER BELLCRANK PARTS

- 700001** Rebuild kit. 1951-62 car, all models & early 1963 car. Includes new shaft & 2 bearings...**\$85.00 ea.**
- 700002** Rebuild kit. Late 1963-66 car, all models & 1967-85 Avanti. Includes new shaft & 2 bushings**\$85.00 ea.**
- 525002** .010 shim.....**\$1.50 ea.**
- 525004** .015 shim.....**\$1.50 ea.**
- 525005** .020 shim**\$1.50 ea.**
- 525007** Shaft seal to go with 525013 bearing...**\$2.00 ea.**
- 525013** Bearing. 1950 Commander & 1951 to early 1963 car, all models. Takes 2.....**\$11.75 ea.**
- 1554379** Bushing. Late 1963-66 car all models & 1967-85 Avanti. Takes 2.**\$12.50 ea.**
- 1554380** Shaft seal to go with 1554379 bushing**\$2.00 ea.**



Note: We have more Drag link assemblies for the larger trucks. Please inquire.

REACH ROD OR DRAG LINK

REACH ROD ENDS

- 520111** Truck: 1949-56 1/2 & 3/4 ton. 1st type with left hand thread.**\$90.00 ea.**
- 681512** Truck: 1949-56. All big trucks**\$52.00 ea.**
- 1689384** Truck: 3E-6E 1-14 & 7E 5, 7, 10, 12, 13, 15. 2nd type with right hand thread. Pictured..**\$42.60 ea.**
- 520115** Drag link. 1947-49 Commander. Pictured above, right.....**\$52.00 ea.**
- 526567** 1950 Commander**\$52.00 ea.**
- 532063** All 1951-52 car.....**\$250.00 ea.**
- 533059** All 1953-54 Sedan & Station Wagon without power steering.....**CALL**
- 1542004** 1958-66 Sedan & Lark & 1963-85 Avanti with manual steering. NOS**\$165.00 ea.**



- 1561778** 1958 Sedan, 1959-66 Lark & 1963-85 Avanti with power steering.....**\$85.00 ea.**
- 1546219** 1958-63 Hawk with Bendix power steering.....**\$125.00 ea.**
- 1561779** 1964 Hawk with Bendix power steering.....**\$125.00 ea.**
- 1542005** Drag link for all the following with manual steering, 1957-58 Hawk V-8 and 1959-64 Hawk except early 1959 6-cylinder...**\$255.00 ea.**
- 1689414** Truck: 1960-64 5E-8E with power steering. 13".....**\$225.00 ea.**
- 1692249** Truck: 1960-early 1962 3/4 ton models 10, 11, 12.....**\$250.00 ea.**
- 1695660** Truck: Late 1962 1/2 ton models 5 & 7 (After serial #'s E5 - 135, 294 or E7 - 18,075**\$250.00 ea.**
- 1695704** Truck: Late 1962 3/4 ton models 10 & 12 after serial # E10 - 39,675 or E12 - 5646.....**\$250.00 ea.**



- 666252** M5 pickup before serial number M5 3,238. Pictured below**\$75.00 ea.**
- 666822** M5 pickup after serial number M5 3,238.....**\$272.25 ea.**

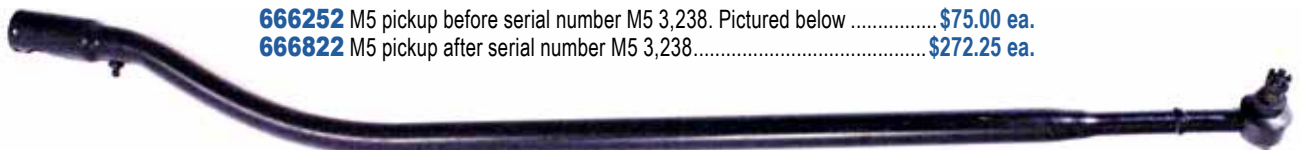

TIE ROD PARTS

182898 Tie rod assembly, Short side. 1935 Dictator 2A Pictured, right.....
.....\$125.00 ea.

184173 Tie rod end, right. Late 1935 Dictator 2A, 1935 Commander 8 & President, 1936 Dictator 4A, 1937 Dictator 6A & President.....
.....\$95.00 ea.

193383 Tie rod assembly with ends, right side. 1938 car & early 1939 Commander ...\$275.00 ea.

193384 Tie rod assembly with ends, left side. 1938 car & early 1939 Commander\$75.00 ea.

198180 Tie rod assembly, right or left side. 1939-46 Champion\$125.00 ea.

199203 Tie rod end, left. 1934-37 Dictator A, 1A, 3A, 5A & Coupe Express.....\$50.00 ea.

199204 Tie rod end, right. 1934-37 Dictator A, 1A, 3A, 5A & Coupe Express.....\$50.00 ea.

199207 Tie rod end, outer right or inner left. Late 1940 & all 1941-46 Champion.....\$80.00 ea.

199208 Tie rod end, inner right or outer left. Late 1940 & all 1941-46 Champion.....\$80.00 ea.

199212 Tie rod end. Left side, spring loaded. 1937 Dictator 6A & President.....\$95.00 ea.

199213 Tie rod end. Right side, spring loaded. 1937 Dictator 6A & President.....\$80.00 ea.

513301 Tie rod assembly, right side. 1941-42 Commander & President.....\$135.00 ea.

513302 Tie rod assembly, left side. 1941-42 Commander & President.....\$160.00 ea.

519607 Tie rod assembly, right or left side. 1947-49 Champion.....\$135.00 ea.

519608 Tie rod end. Outer left/inner right. 1947-49 Champion.....
..... Substitute for 199208 or 520439

519609 Tie rod end. Outer right/inner left 1947-49 Champion & inner right or inner left 1950 Champion use 199208.....\$80.00 ea.



520108 Tie rod assembly, right side. 1947-49 Commander\$135.00 ea.

520109 Tie rod assembly, left side. 1947-49 Commander\$162.00 ea.

520110 Tie rod end, inner right. Late 1939 & all 1940-42 Commander & President. Use 520111

520111 Tie rod end, inner left. Early 1939 & all 1940-42 Commander & President. Also outer right for 1947-49 Commander\$90.00 ea.

520112 Tie rod end. Outer right end for late 1939 & all 1940-42 Commander & President. Also inner right for 1947-49 Commander\$54.00 ea.

520113 Tie rod end. Outer left for late 1939 & all 1940-42 Commander & President. Also inner left for 1947-49 Commander\$55.25 ea.

526570 Tie rod end. Inner left outer right for 1950 Commander\$47.50 ea.

526571 Tie rod end, outer left inner right. 1950 Commander\$45.00 ea.

527977 Tie rod with clamps. 1951-62 car. 21 5/16" long.....\$55.50 ea.

530202 Tie rod rubber boot. 1951-66 all models. Duplicate of original through 1963.....
.....\$2.50 ea.

530203 Tie rod end, outer right & inner left. 1951-early 62 car, all models. Right hand thread...
\$45.00 ea.

530204 Tie rod end, inner right & outer left. 1951-early 62 car, all models. Late 1962-1963 inner. Left hand thread.....\$45.00 ea.

664824 Right tie rod end. Truck: 1941-48 M16 & M17. Early 2R16 & 2R17\$94.00 ea.



666193
666194
530202

666007 Left tie rod end. Truck: 1941-48 M16 & M17. Early 2R 16 & 2R 17\$94.00 ea.

666193 Right tie rod end. Truck: 1941-62 1/2 ton & all truck models 12-15 1949-64. Pictured above.\$38.00 ea.

666194 Left tie rod end. Truck: 1941-62 1/2 ton & all truck models 12-15 1949-64. Pictures above.\$49.50 ea.

666292 Right rod end. Truck: M15-M15A.....\$40.00 ea.

666293 Left tie rod end. Truck: M15-M15A.....\$45.00 ea.

684163 Right tie rod end. Truck: late 2R16 & 2R17. 1954-64 models 25-45\$55.00 ea.

684164 Left tie rod end. Truck: late 2R16 & 2R17. 1954-64 models 25-45\$55.00 ea.

1553703 Rod with clamps. Late 1962-66 car all models & 1963-85 Avanti.....\$19.50 ea.

1554236 Outer tie rod end, long. Late 1962-63 car, all models.....\$193.00 ea.

1561767 Outer tie rod end, long. 1964-66 car, all models & 1964-85 Avanti.....\$170.00 ea.

1561769 Inner tie rod end, short. 1964-66 car all models & 1964-85 Avanti.....\$46.50 ea.

1554236



AUXILIARY TIE ROD ASSEMBLIES & ENDS For cars with 3-tie rod setup



193134 Assembly. All 1938-39 cars except Champion\$103.80 ea.

197157 Assembly. 1939-40 Champion.....\$95.00 ea.

198579 Assembly. 1940-42 Commander & President.....\$78.00 ea.

198588 Assembly. 1941-46 Champion. Pictured above.....\$75.00 ea.

199207 Left end, only. All 1939 & early 1940 Champion\$40.00 ea.

199208 Right end, only. All 1939 & early 1940 Champion\$80.00 ea.

520345 Left end, only. 1938-49 Commander & President.....\$50.00 ea.

520346 Right end, only. 1938-49 Commander & President.....\$50.00 ea.

520438 Right end, only. 1947-49 Champion.\$80.00 ea.

520439 Left end, only. 1947-49 Champion.\$80.00 ea.

FRONT STABILIZER BAR RELATED PARTS

419932 Link bushing for 1545231. 1958-early 1963 car and Avanti to #1815**\$4.00 ea.** 

522518 Rubber bushing. 1950 Champion & Commander 1947-50. Takes 2**\$10.00 ea.** 

522673 Grommet, control arm stabilizer shaft link. 1947-50 Commander & 1950 Champion. Takes 8.**\$3.00 ea.** 

529391 Retainer for sway bar bushings on all 1951-66 cars. Takes 4.**\$22.00 ea.**

529392 Rubber bushing. 1951-57 car all models. Takes 4**\$9.50 ea.** 



801362 Front stabilizer bar 1" Diameter. 1951-66 cars. Comes with new bushings. Must use 1963-66 mounting hardware. Not original but a nice addition for greater stability.**\$347.00 ea.**

1539470 Front stabilizer bar. 1961-66 6-cylinder**\$60.00 ea.**

1539472 Rubber bushing. 1958-66 car all models & 1963-83 Avanti. Takes 4**\$10.00 ea.** 



1545231 Center link assembly. 1958- early 1963 car & Avanti to #1815. Includes top bushing & sleeve. Lower section.**\$44.00 ea.**

1558373 Bracket to frame. 1963-66 Lark, Hawk & 1963-85 Avanti.**\$51.00 ea.** 

1702181 Rubber bushing. 1984-85 Avanti with 1" bar. Takes 4 ..**\$16.50 ea.** 

1702280 Rubber bushing. 1984-85 Avanti with 7/8" bar. Takes 4.**\$12.50 ea.** 

HEAVY DUTY STABILIZER BAR CONVERSION KIT

800710 Provides firmer handling and improves suspension. Kit includes 1" front sway bar, 3/4" rear sway bar and all necessary brackets and bushings. 1963-85 Avanti**\$585.00 kit**

REAR STABILIZER BAR KITS

Already assembled - Reduces lean on corners & improves ride. All 1953-66 Sedan and 1953-64 C & K. Includes Hawk.*

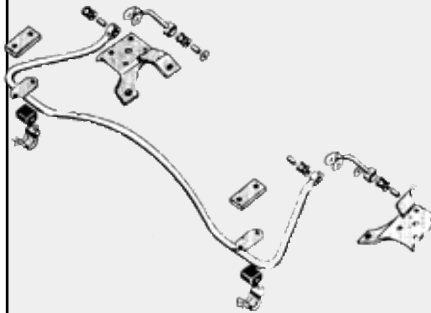

801447 1953-58 car, all models. Does not include lower spring plate **\$495.00/kit**

801448 1959-62 Lark. Includes lower spring plate **\$595.00/kit**

801820 1959-62 Hawk. Includes lower spring plate. **\$595.00/kit**

801821 1963-66 Lark. Includes lower spring plate **\$595.00/kit**

801822 1963-66 Hawk. Includes lower spring plate **\$595.00/kit**

*Kit comes complete with all mounting hardware.

REAR TRACTION BAR KITS

Add traction bars (radius rods) to your Studebaker to eliminate wheel hop and spring wrap-up under hard acceleration.

Kit Includes

- **800537** rear axle bracket, left
- **800538** rear axle bracket, right
- **800539** or **800540** frame bracket (2)
- **1557384** or **1560526-7** traction bar (2)
- **1557385** rubber bushing (4)
- **1557388** bushing spacer (2)

1953-66 Sedan (Includes Lark)

Total of all parts if purchased separately **\$316.00**

800786

Special Package Price **\$290.00/kit**

1953-64 C & K (Includes Hawk)

Total of all parts if purchased separately **\$281.00**

801446

Special Package Price **\$260.00/kit**

REAR STABILIZER BAR RELATED PARTS 1947-64

198685 Inner bushing. 1947-64 all models except Avanti. Link bushing. Takes 4.**\$7.50 ea.** 

522518 Rubber bushing. 1947-64 all models & 1963-85 Avanti. Takes 2.**\$10.00 ea.** 

529392 Rubber bushing. 1963-85 Avanti. Takes 2.**\$9.50 ea.** 

1554004 Shaft link grommet. 1963-85 Avanti. Takes 4.**\$4.35 ea.** 

1557476 Outer bushing retainer. 1947-64 all models & 1963-85 Avanti. Takes 2**\$20.50 ea.** 

REAR TRACTION BAR RELATED PARTS

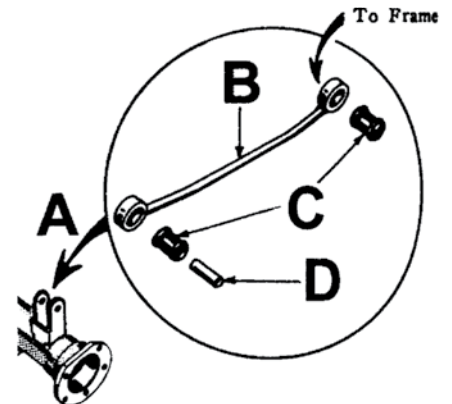

(A) **800537** Rear axle bracket, left. 1963-64 Lark, Hawk & 1963-85 Avanti.**\$42.50 ea.**

(A) **800538** Rear axle bracket, right. 1963-64 Lark, Hawk & 1963-85 Avanti.**\$42.50 ea.**

800539 Frame bracket. 1963-64 Hawk & 1963-85 Avanti**\$40.00 ea.**

800540 Frame bracket. 1963-64 Lark**\$40.00 ea.**

(B) **1557384** Traction bar. 1963-85 Avanti & Hawk**\$62.50 ea.**

(B) **1560526** Traction bar, right. 1963-64 Lark.**\$62.50 ea.**

(B) **1560527** Traction bar, left. 1963-64 Lark.**\$62.50 ea.**

(C) **1557385** Rubber bushing, takes 4. 1963-64 Lark, Hawk & 1963-85 Avanti.**\$9.50 ea.**

(D) **1557388** Bushing spacer. 1963-64 Lark, Hawk & 1963-85 Avanti. Takes 2.**\$13.50 ea.**

REAR AXLE SHAFT BEARING PARTS

- 127013** Cup. 1928-29 Dictator "GE" **\$28.00 ea.**
130408 Cup. 1929-30 Dictator 6 & 8, 1931-33 Studebaker 6, 1932 Rockne "41", 1931-32 Dictator 8 & 1933 Commander 8..... **\$16.00 ea.**
165048 Cup. 1932-33 Rockne 65 & 67. 1934-37 Dictator 6..... **\$27.00 ea.**
165167 Cup. 1929 Commander 6, 1929-30 Dictator 6 Delivery. All 1929-32 Dictator 8 plus 1933 President, 1939-50 Champion & 1951-64 car, all models & 1963-64 Avanti with tapered axle. Truck: 2E-4E 10, 11, 12. Takes 4. **\$13.00 ea.**
174330 Bearing. 1932 Rockne "41", 1932-33 Studebaker 6, 1932 Dictator 8, 1933 Commander 8..... **\$29.00 ea.**
187627 Cup. 1936-37 President..... **\$26.00 ea.**
192238 Cup. 1938-50 Commander & Coupe Express. 1938-42 President. Truck: M5 & 2R-2E 5, 6, 7 & 3E-6E 1-3, 5-7 & 7E-8E 5-7... **\$18.50 ea.**
192239 Bearing. 1938-50 Commander & Coupe Express & 1938-42 President. Truck: M5 & 2R-2E 5, 6, 7 & 3E-6E 1-3, 5-7 & 7E-8E 5, 7..... **\$35.00 ea.**
194826 Bearing. 1939-50 Champion. New production bearing..... **\$169.50 ea.**
510728 Bearing. 1932-33 Rockne 30 & 31. 1934-37 Dictator..... **\$36.00 ea.**
511664 Bearing. 1934 Commander 8..... **\$40.00 ea.**
530451 Bearing. 1951-64 car, all models & 1963-64 Avanti with tapered axle..... **\$46.20 ea.**
1562421 Bearing. 1965-66 car all models & 1964-70 Avanti with flanged axle..... **\$42.55 ea.**

REAR AXLE HOUSING COVERS & COVER GASKETS

- 194839** Cover. 1939-64 all models with 23 or 27 rear axle..... **\$32.00 ea.**
511674 Gasket. 1936-50 Dictator, Commander & Coupe Express, 1934 Commander 8, 1938-42 President. Truck: M5, 2R5 & early 6..... **\$8.50 ea.**
1560244 Cover. 1965-66 with 27 rear axle..... **\$22.80 ea.**
1560245 Gasket. 1939-66 car, all models with #23 or #27 differential..... **\$10.00 ea.**
1561783 Gasket. 1951-66 car, all models & 1963-70 Avanti with #44 differential. Truck: 2R-8E: 1, 2, 3, 5, 6, 7..... **\$10.00 ea.**

REAR AXLE SEALS

- 197216** Felt insert, only. For outer rear wheel seal. 1939-50 Champion. 1951-66 car all models & 1963-70 Avanti with tapered axle..... **\$2.75 ea.**
197591 Felt insert, only. For outer rear wheel seal. 1941-64 1/2 ton pickups & 1947-50 Commanders..... **\$6.60 ea.**
533161 Seal & gasket. 1939-50 Champion. 1951-66 car all models & 1963-70 Avanti with tapered axle. Includes #197436 gasket.... **\$20.00 ea.**

SPECIAL DIFFERENTIAL SEAL KIT

1951-64 Car all models & 1963-70 Avanti (with tapered axles)

1560245

1561783



Kit includes:

- 4 **197436**..... Gasket, outer seals
- 1 **199379X1** & **184161**..... Pinion seal set
- 2 **533161**..... Outer axle seals
- 2 **530573**..... Inner axle seals
- 1 **1560245** (#23 or #27) or **1561783** (#44)..... Rear cover gasket

Total of all parts listed if purchased separately..... **\$108.45**

801041R

Special Package Price..... **\$98.00/kit**

NOTE: Specify DANA #23, #27 or #44 differential when ordering. Number is cast on right lower rear corner of differential below the cover.

Specify year & model when ordering. No substitutions or deletions.

www.studebaker-intl.com
(317) 462-3124

REAR AXLE SHIMS



1939-50 Champion. 1951-66 car all models & 1963-70 Avanti with tapered axles.

- 194844** .005..... **\$4.25 ea.**
194845 .010..... **\$4.25 ea.**
194846 .030..... **\$4.25 ea.**

REAR AXLE PINION SEALS

199379X1 & 184161 Seal & gasket set. 1947-66 car, all models & 1963-70 Avanti. 1939-46 Champion & 1938-42 Commander & President. 1935-37 Dictator. 1937-39 Coupe Express. Truck: M5 & 2R-8E 1, 2, 3, 5, 6, 7..... **\$19.45 set**



- 630680** Truck: 1941-48 M15 & M16, 2R, 14, 15, 16, 28 with split type rear axle..... **\$20.00 ea.**
640666 Truck: 1941-56 with 2-speed..... **\$32.00 ea.**
677658 Truck: 1949-55 3/4-ton..... **\$25.00 ea.**
678138 Truck: 1949-61 16-28 with banjo-type rear end..... **\$25.00 ea.**
683328 Truck: 1954-56 13-14-15 & 1957-58 models 16 & 28 with banjo-type rear end..... **\$28.00 ea.**
911600 Truck: 1957-64 model 40 with heavy duty rear axle..... **\$25.00 ea.**
1685551 Truck: 1956-64, 3/4-ton. Spicer..... **\$28.00 ea.**
1686005 Truck: 1957-61 with 2 speed rear axle..... **\$20.00 ea.**
1688762 Truck: 1957-64 model 40 with standard rear axle..... **\$28.00 ea.**
1689046 Truck: 1962-64 7E & 8E models 40 & 45 with 2 speed rear axle..... **\$38.00 ea.**
1691942 Truck: 1962-64 13 & 15 with Timken axles..... **\$20.00 ea.**

REAR AXLE BUMPERS



433812 1958-64 Hawk & 1961-64 Lark with 4-speed, 1962-66 Lark 4-door..... **\$12.00 ea.**

- 530333** 1951-57 Champion, all. 1958 Champion except C & K, 1951-54 Commander, all & 1956-57 Station wagon. Trucks: Late 2R5-8E 5, 6, 7, 10, 11, 12..... **\$10.00 ea.**
1547536 1953-66 most models and 1963-85 Avanti..... **\$8.00 ea.**

REAR AXLE HARDWARE



- 63X33** Nut. 1934-50 Commander, President, Dictator..... **\$8.00 ea.**
194841 Shaft key. 1947-50 Champion & 1951-66 car all models & 1963-64 Avanti..... **\$5.50 ea.**
510516 Nut. 1951-64 car. 1934-37 Dictator. 1934 Commander & 1951-64 car all models & 1963-64 Avanti..... **\$18.50 ea.**
537906 Nut. 1939-50 Champion..... **\$8.00 ea.**

REAR AXLE SEALS

- 197436** Gasket, differential to brake backing plate. 1939-50 Champion. 1951-66 car all models & 1963-70 Avanti with tapered axle**\$1.50 ea.**
- 516329** 1938-50 Commander. 1938-42 President. Truck: M5 & 2R, 3R & E 5, 6, 7.....**\$18.50 ea.**
- 516330** 1939-50 Champion**\$20.00 ea.**
- 530573** 1951-66 car, all models & 1963-70 Avanti with tapered axle.....**\$18.00 ea.**
- 665620** 1941-48 M16-M17 Truck & all big trucks thru 1964**\$18.00 ea.**
- 677318** Truck: 2R-2E 10, 11, 12.....**\$21.50 ea.**
- 1685410** Truck: 2E: 5, 6, 7 & 3E-6E: 1, 2, 3, 5, 6, 7 & 7E, 8E: 5, 7.....**\$25.50 ea.**
- 1685869** Truck: late 2E, 3E-6E: 10, 11, 12 & 7E-8E: 10, 12.....**\$20.50 ea.**

FRONT WHEEL GREASE SEALS



- 191703** 1938-49 Commander & President. Truck: M5 & 2R 5 (early)...**\$11.50 ea.**
- 194288** 1939- early 48 Champion.....**\$20.70 ea.**
- 524096** 1950 Commander. Truck: (late) 2R-6E 1, 2, 3, 5, 6, 7, & 7E-8E 5, 7.....**\$16.00 ea.**
- 665604** Truck: M16, 17 & 2R-6E: 16, 17, 28, 38 & 7E-8E 25, 28, 35**\$18.50 ea.**
- 677314** Late 1948-55 Champion & 1951-55 Commander & President. Truck: 2R-2E: 10-12**\$14.95 ea.**
- 1539027** 1956-66 car, all models & 1963-83 Avanti.....**\$9.00 ea.**
- 1685868** 1957-61 truck models 10-12 with conventional front axle & 1962-64 models 10-12...**\$29.95 ea.**

WHEEL STUDS & NUTS

- 196308** Lug nut, right hand thread. 1939-50 Champion. 1951-66 car, all models. Truck: 2E-6E 10, 12 & 3E, 4E 4WD 2, 3, 6, 7 & 7E 10, 12. **\$1.25 ea.**
- 196309** Lug nut, left hand thread. 1939-50 Champion & 1951-58 car, all models**\$1.65 ea.**
- 196930** Wheel stud, right hand thread. 1939-50 Champion & 1951-63 car, all models except those with disc brakes. Exact duplicate of original with correct shoulder.....**\$2.50 ea.**
- 196931** Wheel stud, left hand thread. 1939-50 Champion & 1951-58, cars, all models.**\$3.50 ea.**
- 511300** Nut. Fits 523702 stud**\$3.75 ea.**
- 511301** Nut. Fits 523703 stud**\$3.75 ea.**
- 523702** Wheel stud, right hand thread. All 1938-50 cars except Champion. Truck: all 1/2-ton 1941-64.....**\$3.75 ea.**
- 523703** Wheel stud, left hand thread. All 1938-50 cars except Champion. Truck: all 1/2-ton 1941-58.....**\$2.50 ea.**
- 1557509** Wheel stud front, all disc brake cars. 1963-66 & Avanti 1963-83**\$3.50 ea.**



- 1561095** Wheel stud. 1963-66 Lark & Hawk with front disc & 1963-64 Avanti rear...**\$4.50 ea.**

FRONT WHEEL BEARING & GREASE SEAL KIT



- 2 **194211**..... Cup
- 2 **194214**..... Cup
- 2 **194212**..... Bearing
- 2 **194215**..... Bearing
- 2 **194288**..... Seal

801831 1939-40 Champion models 10-piece kit includes inner and outer bearings, cups and grease seals for both sides of vehicle.....**\$250.00/kit**

FRONT WHEEL BEARINGS & RELATED PARTS

- 130980** Inner cup. 1938-49 Commander. Truck: M5 & early 2R 5.....**\$21.50 ea.**
- 130983** Outer cup. 1941-early 48 Champion & 1934-49 Commander. Truck: M5, M15 & early 2R 5.....**\$20.30 ea.**
- 130984** Outer bearing. 1941-early 1948 Champion & 1934-49 Commander. Truck: M5, M15 & early 2R 5.....**\$43.45 ea.**
- 130986** Lock washer, front wheel bearing. 1941-46 Champion & 1947-55 car, all models.**\$4.50 ea.**
- 165052** Outer bearing. 1934-37 President & 1934 Commander. Truck: M15, 15A & 2R-2E 13, 14, 15 & 3E-4E 10-14 & 7E - 8E 10, 12, 13, 15.**\$53.80 ea.**
- 167480** Inner bearing. 1938-49 Commander. Truck: M5 & early 2R 5.....**\$33.50 ea.**
- 188102** Dust cap. 1930-31 Rockne, 1939-46 Champions. All cars 1934-55 except Presidents prior to 1938. Trucks: All 1/2 ton 1941-64 & some 7E & 8E 3/4 ton.....**\$15.00 ea.**
- 194211** Inner cup. 1939-early 48 Champion.....**\$21.00 ea.**
- 194212** Inner bearing. 1939 - early 1948 Champion.**\$42.65 ea.**
- 194214** Outer cup. 1939-40 Champion.....**\$25.65 ea.**
- 194215** Outer bearing. 1939-40 Champion**\$54.70 ea.**
- 194290** Dust cap. 1939-40 Champion**\$15.00 ea.**
- 473256** Outer bearing. 1956-66 car all models & 1963-83 Avanti. Truck: 4E-6E 1, 2, 3, 5, 6, 7 & 7E-8E 5, 7.....**\$12.50 ea.**
- 473257** Outer cup. 1956-66 car all models & 1963-83 Avanti. Truck: 4E-6E 1, 2, 3, 5, 6, 7 & 7E-8E 5, 7.....**\$6.50 ea.**
- 473258** Inner bearing. 1956-66 car all models & 1963-83 Avanti. Truck: 4E-6E 1, 2, 3, 5, 6, 7 & 7E-8E 5, 7.....**\$14.40 ea.**
- 473259** Inner cup. 1956-66 car all models & 1963-83 Avanti. Truck: 4E-6E 1, 2, 3, 5, 6, 7 & 7E-8E 5, 7.....**\$15.70 ea.**
- 510278** Inner cup. 1934-37 Dictator & 1937 Coupe Express. Truck: M15-17 & 2R-6E 16, 17, 28, 38 & 7E-8E 25, 28, 35.**\$18.40 ea.**
- 510279** Inner bearing. 1934-37 Dictator & 1937 Coupe Express. Truck: M15.....**\$33.15 ea.**
- 661346** Outer bearing. Truck: M15 & 2R 14, 15.**\$61.30 ea.**
- 677308** Inner bearing. Late 1948-55 Champion & 1950-55 Commander. Truck: 2R-2E 5, 6, 7, 10, 11, 12 & 3E 1, 5, 6, 7. (Late 2R5).**\$23.50 ea.**
- 677309** Inner cup. Late 1948-55 Champion & 1950-55 Commander. Truck: 2R-2E 5, 6, 7, 10, 11, 12 & 3E 1, 5, 6, 7. (Late 2R5).....**\$11.00 ea.**
- 677310** Outer cup. 1948-55 Champion & 1950-55 Commander. Truck: 2R-2E 5, 6, 7, 10, 11, 12 & 3E 1, 5, 6, 7. (Late 2R5).....**\$12.50 ea.**
- 677311** Outer bearing. 1948-55 Champion & 1950-55 Commander. Truck: 2R-2E 5, 6, 7, 10, 11, 12 & 3E 1, 5, 6, 7. (Late 2R5).....**\$27.00 ea.**
- 1539025** Dust cap. 1956-66 car all models & 1963-83 Avanti.....**\$13.50 ea.**
- 1543223** Spindle nut. 1934-66 car, most models. 1963-83 Avanti. Truck: M5 & 2R-8E most models**\$8.55 ea.**
- 1692235** 1960-61 truck models 10, 11 & 12 & 1962-64 truck models 10 & 12**\$7.25 ea.**



SHOCK ABSORBER RELATED PARTS

170200 Front shock bushing. 1931-32 Rockne, 1930-31 Studebaker 6, 1934 Dictator "A", 1941-48 M5 & early 2R5 & 2R10 pickups with lever action shocks. Takes 4 **\$2.50 ea.**

170200 Rear shock bushing. Late 1932 Rockne 65, 1933 Rockne, 1930-31 Studebaker 6, 1934 Dictator "A", 1941-48 M5 & early 2R5 & 2R10 pickup with lever action shocks. Takes 4 **\$2.50 ea.**



193878 Front shock grommet. 1947-49 Champion & 1947-50 Commander. Takes 4 **\$3.00 ea.**

195284 Rear shock bushing. 1939-49 Champion & 1947-50 Commander. Takes 4 **\$3.25 ea.**



198685 Rear shock bushing. 1941-42 Commander & President. Takes 4 **\$7.50 ea.**

510568 Metal retainer for front shock grommet. 1950 Champion and all 1951-66 car except Avanti & 1961-66 car with original heavy duty adjustable Gabriel shocks. Takes 8 thru early 1957 & 4 thereafter **\$1.20 ea.**



522673 Front shock grommet. 1950 Champion & all 1951-66 car except Avanti & 1961-66 car with original heavy duty adjustable Gabriel shocks. Takes 8 thru early 1957 & 4 thereafter **\$3.00 ea.**

522777 Metal seat for front shock grommet. 1950 Champion and all 1951-66 cars except Avanti & 1961-66 car with original equipment heavy duty Adjustable Gabriel shocks. 1950-early 1957 takes 4, thereafter takes 2. **\$2.50 ea.**

523300 Spacer for front shock grommet on all 1947-49 cars & 1950 Commander. Also used on rear of 1947-49 Champion **\$2.50 ea.**

523301 Spacer for rear shock grommet on 1947-50 Commander **\$4.70 ea.**

524831 Rear shock upper mounting stud for 1950 Champion & all 1951-early 1957 car **\$9.00 ea.**

524832 Rear shock upper spacer on 1950 Champion & all 1951-early 1957 car. **\$5.00 ea.**

524833 Spacer, lower rear shock. 1950 Champion **\$4.80 ea.**



524834 Spacer, upper rear shock. 1950 Champion **\$6.60 ea.**

531075 Special front shock mounting bolt for late 1957 & all 1958-66 car & Avanti thru 1985. **\$3.50 ea.**

1546133 Front shock bushing. 1937-38 car and early 1939 Commander. Rear, 1950 Champion & all 1951- early 1957 car with original equipment shocks. Takes 8... **\$3.50 ea.**



GABRIEL CLASSIC GAS SHOCK ABSORBERS



FRONT SHOCK ABSORBERS

Gabriel was an original Studebaker & Avanti shock absorber for many years. These high quality shocks enable your Studebaker & Avanti to perform like new.

***800693** 1950 Champion & 1951-early 57 all models **\$35.95 ea.**

***800694** Late 1957-66 all models & 1963-85 Avanti **\$30.95 ea.**

REAR SHOCK ABSORBERS

****800697** 1950 Champion & 1951-56 all models and early 1957 **\$40.95 ea.**

***800698** 1963-66 Lark & Hawk & late 1963-85 Avanti... **\$50.95 ea.**

800930 Late 1957-62 all models and early 1963 Avanti. **\$62.95 ea.**

NOTE: Mounting hardware furnished w/the shocks may not duplicate the original factory pieces, and may require modification or replacement to ensure proper fit.

**** Includes bushings, nuts & metal retainers.**

*** Includes mounting studs, nuts & washers.**

TRUCK SHOCK ABSORBERS

800942 Truck: 1950-60, front & rear **\$30.95 ea.**

1697581 1961-64 Truck. Hydraulic. NOS **\$68.25 ea.**

LEVER TYPE SHOCKS

518009 Right rear. Early 1947 Commander, except Convertible **\$55.00 ea.**

518010 Left rear. Early 1947 Commander except Convertible **\$55.00 ea.**

523497 Right or left rear. Late 1947 & all 1948 Commander except 1947 & early 1948 Convertibles **\$80.00 ea.**

523538 Right rear. 1947 & early 1948 Commander Convertible **\$144.00 ea.**

523539 Left rear. 1947 & early 1948 Commander Convertible **\$120.00 ea.**

526092 Right front. 1950 Commander **\$40.00 ea.**

526093 Left front. 1950 Commander. **\$40.00 ea.**

526148 Right rear. 1950 Commander **\$80.00 ea.**

676683 Left front. Truck: Early 2R 5,10 **\$151.25 ea.**

UNIVERSAL JOINTS



516059 1936-66 all models & 1963-85 Avanti. Truck: 1949-60 various models. Spicer **\$20.00 ea.**

679937 Truck: M5 with 4 speed & early M15's... **\$75.00 ea.**

1559481 1963-64 all models with Mechanics front **\$31.00 ea.**

1559482 1963-64 all models with Mechanics rear. **\$47.75 ea.**

1687069 Truck: 1957-64 with Cleveland. **\$25.00 ea.**

NOTE: 1964 Larks & Hawks use both Spicer & Mechanics U-Joints. Be sure to check yours as to the type before ordering.

The following truck U - Joints are available, check your truck parts book for year & model.

670774 **\$46.00 ea.**

674156 **\$46.00 ea.**

682027 **\$27.00 ea.**

1687083 **\$78.00 ea.**

1687253 **\$46.00 ea.**

1687692 **\$25.00 ea.**

1690409 **\$25.00 ea.**

1691761 **\$27.00 ea.**

1691762 **\$67.00 ea.**

Searching for Studebaker parts?

You are in the right place! Studebaker International is the largest supplier of new-old stock and reproduction Studebaker auto parts.

677156 Right rear. Truck: 2R-3 E 13, 14, 15, 16, 28, 38 **\$178.25 ea.**

677157 Left rear. Truck: 2R-3 E 13, 14, 15, 16, 28, 38 **\$178.25 ea.**

678630 Right front. Truck: 2R-2E 6, 7, 11, 12, 3-E, 5, 6, 7, 10, 11, 12 **\$104.25 ea.**

678631 Left front. Truck: 2R-2E late 2R 6, 7, 11, 12, 3-E, 5, 6, 7, 10, 11, 12 **\$104.25 ea.**

678632 Right rear. Truck: 2R-2E late 2R 6, 7, 11, 12, 3-E, 5, 6, 7, 10, 11, 12 **\$95.00 ea.**

678036 Right front. Truck: 2R-2E 13, 14, 15, 3E 13, 14 **\$129.50 ea.**

678037 Left front. Truck: 2R-2E 13, 14, 15, 3E 13, 14 **\$129.50 ea.**

NOTE: Lever shocks are NOS Even though the shocks are "new", the seals are old & carry no warranty against leakage.

*** We have other lever type shocks too. Please inquire.**

DRIVE SHAFT CENTER SUPPORT BEARING

517450 Bearing. All 1947-49 Cars & early Production 1950 Canadian Champion.
..... **\$56.15 ea.**



664443 Bearing. All 1950-57 Cars (US made) & late 1950 Canadian Champions. Truck: M15, 15A, 16, 17 & 2R-8E all models. Pictured, above
..... **\$47.45 ea.**

DRIVE SHAFT CENTER SUPPORT CUSHION

519175 1947-1957 car, all models. Takes 2 **\$7.50 ea.**



664444 Truck: 1941-48 M15, 16 & 17 trucks with original equipment center support..... **\$10.25 ea.**

679292 & 679293 Truck: 1941-64 with two piece drive shaft **\$6.00 set/4**

SPECIAL DRIVE SHAFT REBUILD KIT

For 1947-57 car all models

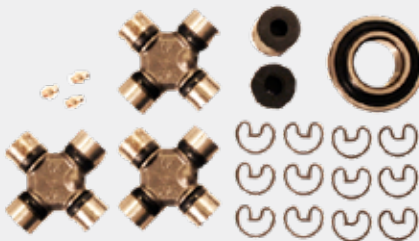

Kit Includes

- 3 516059 U - Joints. Spicer
- 2 519175 Center support cushion
- 1 517450 or 664443 Center support bearing

1947-1949 Cars

US Made & Early 1950 Canadian Champion

Total of all parts if purchased separately **\$143.00**

801042R

Special Package Price **\$134.00/kit**

U.S. MADE 1950-57 Cars & Late 1950 Canadian Champion

Total of all parts if purchased separately **\$134.30**

801043R

Special Package Price **\$126.00/kit**

NOTE: Specify year & model when ordering. No substitutions or deletions.

DIFFERENTIAL & PINION BEARINGS

127013 Cup, rear pinion bearing. Car: 1929-30 Commander 8, GT & FD. 1929-30 Dictator delivery, GL with tapered shaft & key before serial # 3,760,797 **\$28.00 ea.**

127013 Cup, pinion shaft front bearing. 1929-30 Dictator delivery with spline pinion shaft after serial #3,760,797. Also used on GE 1928-29 Dictator & 1932-33 Studebaker 55 & 56. 8-cyl applications are FC & FD 1929-30 Dictator with spline pinion shaft, 1929-30 President, 1932 Dictator 8, 1930-33 Commander 8, 1931-33 President & 1935 Commander & President 8.
..... **\$28.00 ea.**

156682 Bearing rear pinion for cars. GE 1928-29 Dictator with single unit or split carrier with pinion 1 5/8" diameter at drive end. 1934 President with axles dated before 4/11/34.
..... **\$42.00 ea.**

156684 Cup, rear pinion bearing. Car: 1929-30 Dictator delivery after serial# 3,760,797 with tapered shaft. GE 1928-29 Dictator, 1932-33 Rockne 55 & 56, 1929-30 Dictator & Commander 8, 1932 Dictator 8, 1930-33 Commander 8, 1933 President 8 and 1935 Commander & President 8
..... **\$23.00 ea.**

165133 Bearing, rear pinion. Car: GJ 1929 Commander & GL 1929-30 Dictator with tapered pinion shaft & key before serial #3,760,797. Also FD 1929-30 Commander 8 with tapered pinion shaft before serial #8,019,661 **\$47.00 ea.**

177644 Bearing rear pinion. Car: 1933 Studebaker model 56, 1933 & 1935 Commander & President 8. **\$72.00 ea.**

183903 Bearing, rear pinion. Car: 1934 President with axle dated after 4/11/34 and all 1936-37 Presidents **\$42.00 ea.**

183904 Cup, rear pinion bearing. Car: 1934 President with axles dated after 4/11/34 & all 1936-37 Presidents **\$23.00 ea.**

190032 Cup, pinion front. 1965-66 with #44 differential. 1959-64 car all models with #23 or #44 differential. 1947-58 car, all models & 1963-70 Avanti. Truck: M5 & 2R-8E 1, 2, 3, 5, 6, 7, 1936 Dictator & all other 1936-46 cars. **\$20.55 ea.**

190033 Bearing, pinion front. 1965-66 with #44 differential. 1959-64 car, all models with #23 or #44 differential. 1947-58 car, all models & 1963-70 Avanti. Truck: M5 & 2R-8E 1, 2, 3, 5, 6, 7. Late 1936 Dictator & all 1937-46 Commander, Dictator, Champion & 1938-42 President **\$37.20 ea.**

190035 Cup, pinion rear. 1947-58 car, all models. 1959-64 car all models with #23 or #44 differential. 1965-66 with #44 differential & 1963-70 Avanti. Truck: M5 & 2R-8E 1, 2, 3, 5, 6, 7. 1936-46 Dictator & Commander, Coupe Express, Champion & 1938-42 President **\$19.30 ea.**

190036 Bearing, rear pinion. 1947-58 car, all models & 1963-70 Avanti. 1959-64 car all models with #23 or #44 differential. 1965-66 with #44 differential & 1963-70 Avanti. Truck: M5 & 2R-8E 1, 2, 3, 5, 6, 7. Late 1934 Dictator & all 1935-45 Dictator, Commander, Coupe Express & 1938-42 President **\$51.00 ea.**

190047 Cup, differential bearing. 1947-54 Commander. 1955-59 V-8. 1958 Champion. 1959-64 car all models & 1963-70 Avanti. Truck: M5 & 2R-8E 1, 2, 3, 5, 6, 7. Late 1936 Dictator & all 1937-42 Dictator, Commander, Coupe Express & 1938-42 President. Takes 2 **\$23.50 ea.**

190048 Bearing differential. 1947-54 Commander. 1955 car, all models & 1963-70 Avanti. Truck: M5 & 2R-8E 1, 2, 3, 5, 6, 7. Late 1936 Dictator & all 1937-42 Dictator, Commander, Coupe Express & 1938-42 President. Takes 2.
..... **\$51.00 ea.**

192238 Cup, truck differential & rear axle bearing. 1941-64 1/2 ton, all **\$18.50 ea.**

192239 Bearing, truck differential & rear axle. 1941-64 1/2 ton, all. **\$35.00 ea.**

196286 Cup, differential bearing. 1939-58 Champion. 1959-60 with #23 differential.
..... **\$64.85 ea.**

196287 Bearing, differential. 1939-58 Champion & 1959-60 with #23 differential. **\$49.75 ea.**

510693 Cup, rear pinion bearing. Car: 1929-30 Dictator 6, 1930-31 Studebaker 6, 1930-32 Rockne, 1935-36 Dictator and 1934-37 Commander & President 8. Also -cup, pinion shaft front bearing. Car: 1932-33 Rockne 30 & 31, 1934 - early 36 Dictator, 1934 Commander & President 8 and 1936-37 President **\$24.00 ea.**

510694 Bearing, rear pinion for cars. 1932-33 Rockne (30&31); 1934-35 Dictator. Bearing front pinion. 1934-36 Canadian-made Dictator.
..... **\$50.00 ea.**

1549625 Cup, pinion shaft front bearing. 1960-66 with #27 differential. **\$11.00 ea.**

1549626 Bearing, pinion front. 1960-66 with #27 differential. **\$49.05 ea.**

1549627 Cup, rear pinion. 1960-66 with #27 differential rear axle **\$17.60 ea.**

1549628 Bearing, rear pinion. 1960-66 with #27 rear differential. **\$38.50 ea.**

1549645 Cup, differential bearing. 1960-66 with #27 differential. **\$19.75 ea.**

1690219 Bearing differential. 1960-66 with #27 differential. **\$25.25 ea.**

6484102 Bearing, differential. 1965-66 #44 flanged differential. **\$33.75 ea.**

NOTE: The following differential & axle bearings for the larger trucks are available. Please consult your factory parts book for exact year & model application.

181794 Bearing **\$38.25 ea.**

630703 Bearing **\$51.50 ea.**

630728 Cup **\$32.00 ea.**

631956 Cup **\$26.00 ea.**

631959 Bearing **\$32.00 ea.**

634304 Bearing **\$48.00 ea.**

636343 Cup **\$32.00 ea.**

636346 Bearing **\$51.50 ea.**

639182 Cup **\$62.00 ea.**

640080 Bearing **\$41.50 ea.**

662777 Cup **\$30.00 ea.**

664736 Cup **\$24.00 ea.**

674450 Cup **\$24.00 ea.**

677296 Bearing **\$38.25 ea.**

677297 Cup **\$19.50 ea.**

1685901 Bearing **\$31.00 ea.**

1685902 Bearing **\$42.00 ea.**

1685908 Cup **\$30.00 ea.**

1687471 Bearing **\$65.00 ea.**

1690124 Bearing **\$65.00 ea.**

NOS - LEAF SPRINGS FOR TRUCKS

Truck rear springs were available in either single or two stage configuration, and with or without auxiliary springs. We have included the factory parts book illustration numbers (in parenthesis) on all truck springs listed for ease of identification. Refer to factory books.

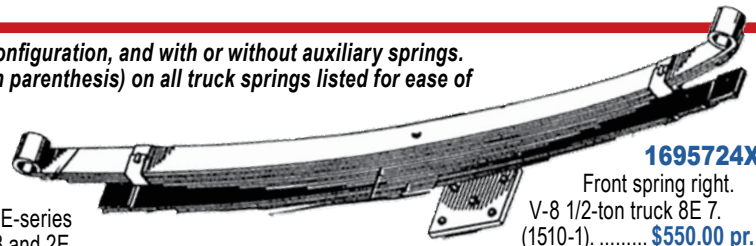

- 673887X** Rear main spring. 2R 16 heavy duty. 2R17 standard duty prior to serial # R16A-17,194 and R17A-9,943. (1518-1) **\$795.00 pr.**
- 677056X** Front spring. Heavy duty on 2R through E models 13, 14, 15. Also standard duty on 2E models 13 & 14. (1510-1) **\$750.00 pr.**
- 677057X** Front spring. Standard duty 2R through E models 16 & 28. **\$750.00 pr.**
- 677058X** Front spring. Standard duty. 2R through E models 17 & 38. Standard duty on 2E models 38 models with 131" wheelbase. Also heavy duty on 2R through E 16 & 28 models. (1510-1) **\$775.00 pr.**
- 677274X** Front spring. Standard duty. 2R through E models 13, 14, 15. Also standard duty on 2E models 13 & 14. (1510-1) **\$725.00 pr.**
- 677526X** Front spring. Standard duty type-A, 2R5 & 2R10 prior to serial # R5-13,771 & R10-5,382. (1510-1) **\$595.00 pr.**
- 677528X** Front spring. Heavy duty type-A, 2R5 & 2R10 prior to serial # R5-14,641 & R10-5,961. (1510-1) **\$650.00 pr.**
- 678734X** Rear main spring. Late 2R 10 after serial # R-10, 19265 and all 2R11 & 12, 15 through 2E 10, 11 & 12. (1518-1) **\$745.00 pr.**
- 678842X** Rear main spring. Late 2R15 and all 2R 13 & 14 through 2E 13, 14, & 15. 2R15's after serial # R15-7,072. (1518-1) **\$765.00 pr.**
- 678846X** Rear main spring. Late 2R15 after serial # R15-8,768 and all 2R through 2E 13, 14, & 15 with 131" wheelbase. (1518-1) ... **\$765.00 pr.**
- 679131X** Front spring. Heavy duty. 2E models 28 & 38. Also heavy duty on 2E 38 with 131" wheelbase and standard duty on other 2E38's. (1510-1) **\$795.00 pr.**
- 679859X** Rear spring. 2-stage light duty late 2R10 after serial # R-10 21,512 & all 2R 11 & 2R 12 through E-10, 11, & 12. (1518-2) ... **\$695.00 pr.**
- 681192X** Rear main spring. Heavy duty. 2R16 after serial # R16-39,498. Also 2R16 & 17. Standard duty after serial # R16A-38,770 and R17A-31,034. 3R through E models 16, 17, 28, 38. Heavy duty on models 16 & 28. Lastly, heavy duty on 2E 28. (1518-1) **\$845.00 pr.**
- 681195X** Rear main spring. 2R17 and extra heavy duty on 2R16. 3R16 through 38, heavy duty on 2R16 & 28. Heavy duty on E17 & 38. And standard duty on 2E 38. (1518-1) **\$845.00 pr.**
- 681903X** Rear main spring. Standard duty. 3R through 2E models 5, 6, 7. (1518-1) ... **\$595.00 pr.**
- 681904X** Rear main spring. 2-stage, light duty. 2R models after serial # R6-11,867. Also 3R and 2E models 5, 6, 7. (1518-2) **\$695.00 pr.**
- 681905X** Rear spring. 2-stage, heavy duty. 2R6 models after serial # R6-11,867. Also 3R and E models 5, 6, 7. (1518-2) **\$695.00 pr.**

- 684053X** Rear main spring. Standard duty. E-series models 16 & 28 and 2E model 28. (1518-1) **\$795.00 pr.**
- 684056X** Rear main spring. Heavy duty. E16, 17, 28 & 38. (1518-1) **\$845.00 pr.**
- 684332X** Rear main spring. 2-stage, heavy duty. E models 16, 17, 28, 38. Also 2E 38 model. (1518-2) **\$845.00 pr.**
- 1685100X** Rear spring. 2-stage heavy duty. 2E models 5, 6, 7. (1518-2) **\$745.00 pr.**
- 1685104X** Rear spring. 2-stage heavy duty 2E models 10,11,12. (1518-2) **\$845.00 pr.**
- 1685189X** Rear spring. 2-stage, light duty 2E models 13 & 14 truck. (1518-2) **\$850.00 pr.**
- 1687598X** Front spring. Heavy duty, on 3E 16 & 28 models and 3E 17 & 38 models with 131" wheelbase. Standard duty on all 3E 17 & 38 models except those with 131" wheelbase and also standard duty on 3E through 8E 35, 40 & 45 models. Lastly, heavy duty on 7E & 8E 25 & 38 models. (1510-1) **\$795.00 pr.**
- 1687673X** Front spring. Standard duty. 3E through 8E 13 & 14 models. (1518-1) (1510-1) **\$725.00 pr.**
- 1687678X** Rear spring. 2-stage standard duty 3E through 8E models 13, 14, 16, 28 and 25. (1518-2) **\$795.00 pr.**
- 1687684X** Rear spring. 2-stage standard duty. 3E thru 8E, 25, 28, 35, 40, 45, 16, 17, 38. Heavy duty on 25 & 28. (1518-2) **\$845.00 pr.**
- 1687701X** Rear spring. Auxiliary standard duty. 2E through 8E models 16, 25, 28. (1518-3) **\$895.00 pr.**
- 1687705X** Rear main spring. Auxiliary, extra heavy duty. 2E through 8E models 16, 25, 28, 35, 40, 45. (1518-3) **\$945.00 pr.**
- 1691609X** Front spring. Heavy duty. 4E though 8E models 40 & 45. (1518-1) **\$795.00 pr.**
- 1691610X** Front spring. Extra heavy duty. 4E though 8E models 40 & 45. (1510-1) **\$895.00 pr.**
- 1693302X** Rear spring. 2-stage standard duty. 6E (1961) through 8E (1964) models 5 & 7. (1518-2) **\$595.00 pr.**
- 1693361X** Rear spring. 2-stage heavy duty. 6E (1961) through 8E (1964) models 5 & 7. Also standard duty on 6E through 8E models 10 & 12 3/4-ton truck. (1518-2) **\$695.00 pr.**
- 1695716X** Front spring, right. 8E 5 & 10 standard duty. Note: probably could be used on either side. (1510-1) **\$645.00 pr.**
- 1695717X** Front spring left. 8E 5 & 10 standard duty. Note: probably could be used on either side. (1510-1) **\$645.00 pr.**

- 1695724X** Front spring right. V-8 1/2-ton truck 8E 7. (1510-1) **\$550.00 pr.**
 - 1695725X** Front spring left. V-8 1/2-ton truck 8E 7. (1510-1) **\$550.00 pr.**
- NOTE: 1695724X and 1695725X should be interchangeable.**
- 1696382X** Front spring right. Heavy duty. 8E 7 & 12 truck. (1510-1) **\$695.00 pr.**
 - 1696383X** Front spring left. Heavy duty. 8E 7 & 12 truck. (1510-1) **\$695.00 pr.**
- NOTE: 1696382X and 1696383X should be interchangeable.**
- 1697206X** Rear spring. Postal Zip Van 8E 5-FC. (1518-2) **\$595.00 pr.**
 - 1697270X** Front spring. Postal Zip Van 8E 5-FC. (1510-1) **\$550.00 pr.**

NOS - REAR LEAF SPRINGS FOR CARS

- 1540059X** 1956 All with A/C except 56 GH. **\$595.00 pr.**
- 1541917X** 1957 Champion 6-cyl. 2-door & 4-door Sedan **\$550.00 pr.**
- 1544352X** 1957 Champion Scotsman 2-door & 4-door Sedan **\$550.00 pr.**
- 1545112X** 1958 Champion All body styles except Station Wagon **\$550.00 pr.**
- 1545113X** Standard duty. 1958 V-8 Sedan & J-Body Hardtops **\$550.00 pr.**
- 1545115X** 1958 4-door Champion Taxi **\$550.00 pr.**
- 1545116X** 1958 Champion 2-door Scotsman Wagon **\$550.00 pr.**
- 1547534X** Heavy duty. 1959-61 Station Wagon **\$595.00 pr.**
- 1547535X** Standard duty. 1959-61 Station Wagon **\$550.00 pr.**
- 1548320X** 1955-61 6-cyl. Hawk. ... **\$550.00 pr.**
- 1552181X** 1961 Cruiser V-8 **\$550.00 pr.**
- 1554563X** Standard duty. 1962 Lark all except Station Wagon. Probably all 1963-66 also **\$550.00 pr.**
- 1555712X** 1962 6-cyl. & V-8 Lark Taxi. **\$550.00 pr.**
- 1556534X** 1962-64 Taxi **\$550.00 pr.**
- 1559758X** Standard duty. 1963-66 Lark all models except Station Wagon **\$550.00 pr.**

Note: NOS Leaf Springs Availability Is Limited To Stock On Hand Which In Some Instances Is Extremely Limited. If Demand Warrants, We May Consider Reproduction Of Certain Units.

NEW PRODUCTION SPRINGS FOR TRUCKS

- 676849** Rear main spring. Standard duty. 2R models 5 & 6. All 2R5's and 2R6's prior to serial # R6-11,867. (1518-1) **\$1,226.00 pr.**
- 679852** Rear spring. Light duty. 2R5 & 2R6. 2R 5 after serial # R5-46,122. 2R6 from serial # R6-202 to R6-11,867. (1518-2) **\$925.00 pr.**

- 1693853** Front spring. Heavy duty. 7E 5 & 10 models. Also standard duty on 7E models 7 & 12. (1510-1) **\$810.00 pr.**

NOTE: Due to age, bushings on NOS leaf springs will often need replacement. Any Truck springs sold that have Type "B" bushing (See page 269) will include new replacement bushings. New bushings are included with all 1951 and later car springs. It is the responsibility of the purchaser to install.

NEW - PRODUCTION REAR LEAF SPRINGS FOR CARS

- 536410** Standard. 1953-57 all models **\$795.00 pr.**
- 536513** Heavy duty. 1953-57 all models **\$810.00 pr.**
- 1545112** Standard. 1958 all Sedans except President..... **\$795.00 pr.**
- 1545113** Standard. 1958 President..... **\$795.00 pr.**
- 1545114** Standard. 1958 Station Wagon & 1959-61 Hawk. **\$795.00 pr.**
- 1545116** Heavy duty. 1958 all Sedans **\$810.00 pr.**
- 1545117** Heavy duty. 1958-61 Station Wagon & Hawk **\$810.00 pr.**
- 1547532** Heavy duty. 1959-61 Lark except Station Wagon **\$810.00 pr.**
- 1547533** Standard. 1959-61 Lark except Station Wagon **\$795.00 pr.**
- 1547534** Heavy duty. 1959-61 Lark Station Wagon **\$810.00 pr.**
- 1547535** Standard. 1959-61 Lark Station Wagon **\$795.00 pr.**
- 1554563** Standard. 1962-64 Lark except Station Wagon **\$795.00 pr.**
- 1554565** Heavy duty. 1962-64 Lark except Station Wagon **\$810.00 pr.**
- 1557249** Standard. 1963-85 Avanti..... **\$795.00 pr.**
- 1557378** Heavy duty. 1963-85 Avanti **\$810.00 pr.**
- 1557636** Heavy duty. 1962-64 Hawk **\$810.00 pr.**
- 1557637** Standard. 1962-64 Hawk..... **\$795.00 pr.**
- 1559758** Standard. 1965-66 Lark except Station Wagon **\$795.00 pr.**
- 1559760** Heavy duty. 1962-64 Lark Station Wagon **\$810.00 pr.**
- 1559760** Heavy duty. 1965-66 Lark except Station Wagon **\$810.00 pr.**
- 1560439** Heavy duty. 1963-66 Station Wagon. **\$810.00 pr.**
- 1560440** Standard. 1962-66 Lark Station Wagon. Heavy duty for 1965-66 Lark except Station Wagon **\$810.00 pr.**

COIL SPRINGS PARTS

- 1560480** Front coil spring spacer 1/2". 1951-61 car all models & 1963-85 Avanti **\$22.50 ea.**
- 1526249** Front coil spring end pad, 1950-66 car all models, (Takes 4) **\$.85 ea.**

NOTE: The prior installation height of any spring has no bearing on the installed height. Generally, the weaker springs are taller, the coil stock is smaller, and the distance between coils is greater than a spring that is made for heavier applications.

FRONT & REAR LEAF SPRING Related Parts

NOTE: Additional rear spring U-bolts are listed on page 286.

- 194401** Rear leaf spring U-bolt. 5 1/4" 1939-42 Champion. **\$7.00 ea.**
- 196638** Front spring bumper. 1939-40 Champion. Upper front on '37 Dictator 6A, '37 President, all 1938 cars, '39 Coupe Express and early 1939 Commander..... **\$13.00 ea.**
- 196712** Front leaf spring U-bolt. 5 1/4" 1939-4 Commander, 1939-42 President..... **\$9.50 ea.**



- 515274** Front spring bumper U-bolt. 1942 Commander & President..... **\$14.50 ea.**
- 518976** Front leaf spring U-bolt, 4 1/16" 1947-49 Commander. **\$13.45 ea.**
- 520415** Pad, rubber insulator leaf spring. All 1947-49 cars. Takes 2..... **\$32.00 ea.**



- 521517** Front leaf spring U-bolt, 3 13/16" 1947-49 Champion..... **\$16.15 ea.**
- 526675** Rear spring bumper, 1950 car. Front spring bumper 1947-49 car. **\$14.40 ea.**
- 529168** 4-1/2" end/end shackle, 1953-66 car **\$7.50 ea.**



- 526122** Front coil spring, heavy duty. 1953-66 car all models except Avanti. **\$322.00 pr.**
- 526127** 1955 V-8 Coupe & Hardtop and early 1956 V-8 Hawks. Except G. H. **\$195.00 pr.**
- 526133** 1955-58 6-cyl. Station Wagon, all and 1958 Scotsman Wagon **\$195.00 pr.**
- 526135** Front coil spring. 1963-85 Avanti.. **\$325.00 pr.**
- 1539500** Most 1956 - early 1957 Champion. Except Station Wagons. **\$195.00 pr.**

- 529169** 4" end/end shackle, 1953-66 plus 1963-85 Avanti..... **\$9.92 ea.**
- 532406** Rear spring bumper. 1953-57 V-8 cars. **\$12.50 ea.**
- 678730** Rear spring bumper, 1949-64 big truck. Model #13 & larger..... **\$14.00 ea.**
- 770206** Rear spring U-bolt kit. 1951-66 all models & 1963-85 Avanti with #44 rear axle **\$48.85 set/4**
- 770206X1** Rear spring U-bolt kit, 1947-66 All models w/ #23 or #27 rear axle. **\$72.00 set/4**
- 770210** Rear spring shackle bolt kit includes 6 bolts & nuts. 1951-57 all models **\$24.00 set**
- 770210X** Rear spring shackle bolt kit includes, 6 bolts & nuts. 1958 and later cars including Avanti **\$24.00 set**

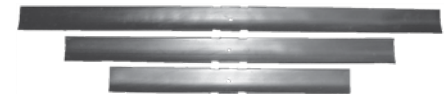

- 801627** Rear spring liner kit, 1953-61 cars. Fits between rear leaf springs to reduce noise. Includes 6 liners enough for 2 springs. Will also work on later model cars to keep springs quiet..... **\$35.00 set/6**

- 1554542** Insulator pad. 1962-66 & 1963 - 85 Avanti. **\$3.00 ea.**
- 1554546** Strap. 1962-66 various models car and 1963-85 Avanti..... **\$12.50 ea.**

- 1554550** Rubber liner for 1554546 strap..... **\$2.50 ea.**
- 1554620** Insulator pads, rear spring. 1962-66 car all models & 1963-70 Avanti. Takes 4. **\$6.35 ea.**

FRONT COIL SPRINGS Car

Others available - Please call!

- 1541865** Late 1957 Champion **\$195.00 pr.**
- 1541866** 1957 V-8 Sedan and 1958 Champion with A/C **\$195.00 pr.**
- 1541868** 1958 6-cylinder Champion. All body styles with A/C..... **\$195.00 pr.**
- 1547373** 1959-60 6-cyl. cars. Some depending on serial number. **\$195.00 pr.**
- 1555081** 1962 6 cylinder without air conditioning. **\$195.00 pr.**
- 1555082** 1962-63 Lark 6 cylinder without air conditioning, 1963 Station Wagon without A/C. 1963 6-cyl. Hawk. Europe..... **\$195.00 pr.**
- 1555084** 1963 6-cyl. Convertible with air conditioning, 1963 sliding roof 6-cyl. Wagon with A/C. 1963 Sliding roof V-8 Wagon without A/C. 1963 Non sliding roof wagon with A/C and all 1963 V-8 Larks with A/C..... **\$195.00 pr.**
- 1561664** Front coil spring standard duty, 1953-66 V8's all except Avanti **\$325.00 pr.**
- 1561666** 1966 Commander 6-cylinder **\$195.00 pr.**

FRONT SPRING BUSHINGS - Trucks Typical Front Springs

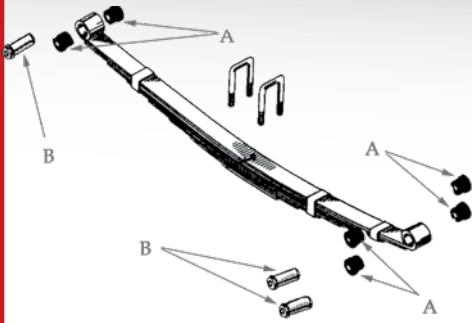

Type A Models (12 per vehicle)

- Model M5, M15, M15A, M16, M17
- Model 2R-2E 5, 6, 7, 10, 11, 12, 13,14,15, 16, 17, 28, 38
- Model 3E-7E 5,7,10,12

196643	1941-48 M5.....	\$2.50 ea.
524976	1949-62 Models 5-12.....	\$3.00 ea.
677071	1941-48 M15,15A,16,17 ...	\$3.75 ea.
677272	1949-56 Models 13-38.....	\$3.00 ea.

Type B Models (6 per vehicle)

- Model 3E-8E 13, 14, 16, 17, 25, 28, 35, 38, 40, 45
- Model 8E 5, 7, 10, 12

685029	1957-64 Models 13-45.....	\$13.50 ea.
1696946	1963-64 Models 5-12.....	\$22.00 ea.

REAR SPRING BUSHINGS - Trucks Typical Rear Springs

Type A Models

- Model M5, M15, M15A, M16, M17
- Model 2R5-5E 1, 2, 3, 5, 6, 7
- Model 2R-8E 13-15

196643	1941-48 M5. Takes 12.....	\$2.50 ea.
524976	1949-52 early 5 & 6 models. Takes 8..	\$3.00 ea.
665121	1941-48 M15. Takes 4.....	\$8.00 ea.
677223	1949-64 2R-8E 13-45. Takes 4.....	\$10.25 ea.
677272	1949-53 2R5 all & early 2R6. Takes 4	\$3.00 ea.
677272	Late 2R6, 3R 1, 2, 3, 5, 6, 7, 2R-E 10,	\$3.00 ea.
	11, 12. Takes 12.....	

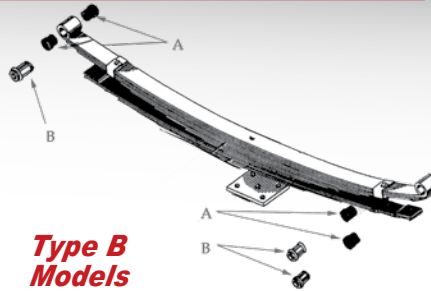

Type B Models

- Model 2E-8E 10, 11, 12
- Model 6E-8E 5, 7
- Model 3E-4E 2, 3, 6, 7 with 4WD

685029	1956-64 2E-8E Models 10, 11, 12	\$13.50 ea.
	also 1961-64 6E-8E 5, 7, also 1957-58 3E &	
	48 Models 2, 3, 6 and 7 with 4WD. Takes 6.	

CAR SPRING BUSHINGS

- (A) **196643** Rubber bushing. 1939-48 Champion & 1940-48 Commander, front & rear. 1940-42 President..... **\$2.50 ea.**
- (A) **524976** Rubber bushing.1949-50 car, all models, rear spring rear..... **\$3.00 ea.**
- (B) **536517** Bushing, front of rear spring. 1955-57 car most models. 1-3/8 OD..... **\$14.50 ea.**
- (B) **1539484** Bushing, front of rear spring. 1958-66 car, most models & 1963-85 Avanti. 1-1/2 OD..... **\$15.00 ea.**
- (D) **1695854** Bushing, front spring. 1963-64 1/2 & 3/4 ton pickup. Takes 6..... **\$16.00 ea.**

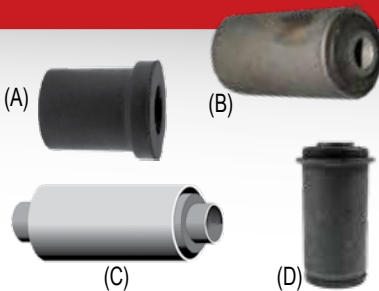

- (C) **524977** Bushing, front of rear spring. All 1949-50 cars. Takes 2..... **\$14.00 ea.**
- 527987** Bushing, 1951-57 car, all models. 7/8 OD..... **\$12.00 ea.**
- (C) **1544481** Bushing, 1958-66 car, all models & 1963-85 Avanti. 7/8 OD... **\$12.00 ea.**

NOTE: When ordering rear spring front bushings for cars 1955-1961 (I.E. 536517, 1539484, & 1544481) It is recommended that you measure the O.D. of your old bushings.

SPECIAL FRONT SUSPENSION KITS FOR 1951-66 CAR ALL MODELS & 1963-85 AVANTI

Kit includes:

- 2 king pins rebuilt with upper & lower bushings.* 1953-60, NOS.
- 1 king pin rebuild kit containing all bearings, bushings, shims and seals for both sides*
- 4 tie rod ends
- 2 tie rods with clamps
- 1 rebuilt center bellcrank with new pin and bearings**
- 2 upper outer pin kits
- 2 lower outer pin kits
- 4 upper inner a-arm bushings
- 4 lower inner a-arm bushings
- 1951-52 only - Inner a-arm bushing kit
- 2 upper a-arm bumpers
- 2 lower a-arm bumpers
- 1 Extra long Zerk fitting

1951-52 Car

Total of all parts listed if purchased separately\$1,593.70
Special Kit Price \$1,514.00/kit
 —15% quantity discount. See page 6
 \$227.10

801390R Your cost..... \$1,286.90/kit

Early 1953-1960 Car & 1961 Hawk

Total of all parts listed if purchased separately \$1,417.80
Special Kit Price \$1,346.00/kit
 —10% quantity discount. See page 6..... \$134.60

801050R Your cost.....\$1,211.40/kit

1961 Lark, Early 1962 Lark & Hawk

Total of all parts listed if purchased separately \$1,717.60
Special Kit Price \$1,631.00/kit
 —15% quantity discount. See page 6
 \$244.65

802294R Your cost..... \$1,386.35/kit

Late 1962-66 & 1963-85 Avanti

Total of all parts listed if purchased separately \$2,034.60
Special Kit Price \$1,932.00/kit
 —15% quantity discount. See page 6
 \$289.80

801051R Your cost..... \$1,642.20/kit

NOTE: When ordering specify year and model of car. No substitutions, or deletions.

Core charge is not discountable. Invoice must be included with core for refund.

- Refundable core charge of \$200.00 applies.
- Refundable core charge of \$150.00 applies

A-ARM BUSHINGS, PINS, & BUMPERS



185792 Bushing. Upper outer a-arm pins. 1936-37 Dictator 4A & 6A, 1938-early 39 Commander & 1938-40 President. Takes 4..... **\$28.00 ea.**

191679 Pin. Upper outer a-arm. 1936-37 Dictator 4A & 6A, 1938-early 39 Commander, 1938 Coupe Express & 1938-40 President. Takes 2..... **\$32.00 ea.**

194247 Bushing. Upper inner a-arm. Late 1939 & all 1940 Commander, 1939 Coupe Express & 1939-40 President. Takes 8..... **\$5.00 ea.**

194347 Bushing. Upper outer a-arm pins. Late 1939 Commander, all 1939 Coupe Express, 1940 Commander & 1939-40 President. Takes 8. **\$8.00 ea.**

194392 Bushing. Upper outer a-arm pin. 1939-40 Champion with #196046 pin. Takes 4. **\$6.50 ea.**



195897 Pin. Upper outer a-arm. Late 1939-40 Commander & Coupe Express. Takes 2..... **\$15.00 ea.**

196046 Pin. Upper outer a-arm. 1939-40 Champion. Plain. Takes 2..... **\$28.00 ea.**

199378 Bushing. Upper outer a-arm pin. 1941-42 car, 1939-40 Champion with threaded pins & 1946 Champion. Takes 4. **\$18.00 ea.**

199385 Seal, Lower pin (531192), 1951-85 car. Takes 4..... **\$7.00 ea.**

199388 Bushing. Upper inner a-arm. 1941-42 car except Champion. Takes 8..... **\$4.50 ea.**



199430 Pin. Upper outer a-arm. 1941-46 car. Takes 2..... **\$28.80 ea.**

514166 Pin. Upper outer a-arm. 1939-40 Champion. Threaded. Takes 2..... **\$35.00 ea.**

517563 Bumper, upper a-arm rebound. 1947-49 Champion & Commander..... **\$33.00 ea.**

519369 Bushing. Upper inner a-arm. 1939-46 Champion. Takes 8..... **\$5.40 ea.**



519877 Bumper, front spring jounce. 1947-49 all models. Takes 2..... **\$18.00 ea.**



524230 Bumper, lower a-arm. 1950-1966 car all models & 1963-85 Avanti. **\$18.85 ea.**

525035 Seal. Upper pins (531190), 1951-85 car. Takes 4. **\$2.50 ea.**

526337 Bumper, upper a-arm 1950- early 1955. **\$18.00 ea.**

531179 Pin kit. Upper outer. 1950 car, all models. Includes pin, bushing & seals, zirks. **Use 531190**



531180 Pin kit. Upper outer. 1947-49 car, all models. Includes pin, bushing & seals, zirks. Right or Left, check Chassis parts book..... **\$62.40 ea.**

531181 Right or Left, Pin kit. Upper outer. 1947-49 car, all models. Includes pin, bushing & seals, zirks. Right or Left, check Chassis parts book..... **\$62.40 ea.**

531182 Pin kit. Upper inner. 1947-49 car, all models. Includes pin, bushing & seals, zirks. **\$42.00 ea.**

531183 Pin kit, upper Inner. 1950 Champion. Includes pin, bushing & seal, zirks..... **\$54.00 ea.**

531184 Pin kit. Upper Inner. 1950 Commander. Includes pin, bushing & seal, zirks..... **\$54.00 ea.**

531185 Pin kit. Lower Outer. 1947-50 car, all models. Includes pin, bushing & seal, zirks. **\$78.00 ea.**



531186

531186 Pin kit. Lower inner. 1947-49 car, all models. Includes pin, bushing & seal, zirks. Pictured above..... **\$144.00 ea.**



531187 Pin kit. Lower Inner. 1950 all models. Includes pin, bushing & seal, zirks..... **\$90.00 ea.**

531190 Pin kit. Upper Outer. 1951-66 car, all models & 1963-85 Avanti. Includes pin, bushing & seal, zirks. Pictured, above..... **\$85.00 ea.**



531191 Pin kit. Upper inner 1951-52 car, all models. Includes pin, bushing & seals, zirks **\$90.00 ea.**

531192 Pin kit. Lower Outer. 1951-66 car, all models & 1963-85 Avanti. Pictured, above..... **\$85.00 ea.**

532181 Upper a-arm, 1953-66 car all & 1965-85 Avanti..... **\$222.00 ea**



533164

533164 Bushings. Lower a-arm, inner. 1953-66 car, all models & 1963-85 Avanti. Set of 4. **\$88.10 set/4**

1553430 Bushings. Upper a-arm, inner. 1953-66 car, all models & 1963-85 Avanti. Set of 4. Pictured above..... **\$60.00 set/4**

802514 Bushings. Upper & Lower Delrin replacements 1953-66 Cars, and 1963-85 Avanti **\$140.00 set/8**



537461 Bumper. Upper a-arm. Late 1955-66 car, all models & 1963-85 Avanti. Takes 2..... **\$13.50 ea.**



J-2044
Spreader

tool for installing pins in upper and lower A-arms .. **\$65.00 ea.**

If you don't see the part you want, please call (317) 462-3124 and inquire

KING PIN BUSHING & BEARING SETS (Less Pins)

- S-333X1** All 1938 car & early 1939 Commander, less plugs & shims **\$80.00 ea.**
- S-334X1** Late 1939-40 Commander & 1939-40 President, less shims & gaskets. All 1941-42 Commander & President..... **\$80.00 ea.**
- S-335X1** 1934-37 Dictator & Coupe Express (A, 1A, 3A,5A & J5), less gaskets & shims. **\$80.00 ea.**
- S-336X1** Bushing & Bearing set without plugs, shims & gaskets. 1936-37 Dictator & President 4A, 6A, 2C & 3C **\$80.00 ea.**
- S-358X1** 1939-40 Champion with king pins having forging #197744/197745. Less gasket & shims **\$80.00 ea.**
- S-367X1** 1941-46 Champion, less gaskets. **\$80.00 ea.**
- 522042X1** 1947-49 Champion **\$80.00 ea.**
- 522043X1** Early 1947 Commander less gaskets & shims. **\$80.00 ea.**
- 523657X1** Late 1947 & early 1948 Commander less gaskets..... **\$80.00 ea.**
- 525668X1** Late 1948 & all 1949 Commander less gaskets..... **\$80.00 ea.**
- 526844X1** 1950 Champion **\$90.00 ea.**
- 526845X1** 1950 Commander less gaskets. **\$80.00 ea.**

MINOR KING PIN REBUILD KIT



- 800157** 1951-66 car, all models & 1963-85 Avanti. Includes all bearings, bushings, shims & seals to rebuild both sides **\$109.25 ea.**

KING PIN BUSHINGS & BEARINGS

- 140706** Upper thrust bearing. 1939-50 Champion. Late 1947-49 Commander, Truck: M16-17 & 2R-6E 16, 17, 28, 38, 40 & 7E-8E 25, 28, 35, 40 & 45 **\$27.75 ea.**
- 165010** Upper thrust bearing. 1934-37 Dictator & 1935, 38-39 Commander & 1937-38 Coupe Express & 1935-38 President. Truck: 2R-8E 1, 2, 3, 5, 6, 7 & 2R-4E 10, 11, 12. **\$14.80 ea.**
- 196859** Lower bearing. 1939-50 Champion, & 1951-66 all models & 1963-85 Avanti. **\$14.00 ea.**
- 519483** King pin seal, 1947-50 Champion, 1951-66 car, all models & 1963-85 Avanti. **\$1.50 ea.**
- 526815** Upper bushing. 1950 Champion..... **\$8.60 ea.**
- 636965** Upper thrust bearing. 1951-64 all models & 1963-85 Avanti..... **\$25.20 ea.**
- 661403** Upper thrust bearing. Truck: M15, 15A, 2R-3R 14, 15 5E-8E 10, 11, 12..... **\$41.00 ea.**

KING PIN KITS

Kit includes: Pins, bearings, & bushings to rebuild both sides. (Unless otherwise noted)

CAR (NOS Unless otherwise noted)



- S-334** Kit comes without gaskets. Late 1939 Commander, all 1939 Coupe Express & President, all 1940 cars except Champion..... **\$130.00/kit**
- S-349** Early 1939 Champion with king pins having forging number: 195196/195197. Less gaskets **\$170.00/kit**
- S-358** 1939-40 Champion with King pins having forging number: 197744/45. Less gaskets. Pictured, left..... **\$165.00/kit**

- S-367** 1941-46 Champion. Less gaskets..... **\$170.00/kit**
- S-368** 1941-42 all except Champion..... **\$180.00/kit**
- 522042** 1947-49 Champion..... **\$230.00/kit**
- 522043** Early 1947 Commander..... **\$201.00/kit**
- 525668** Late 1947 & all 1948-49 Commander..... **\$160.00/kit**
- 526844** 1950 Champion. Includes rebuilt king pins (2) with new upper & lower sleeves, all bearings, bushings, shims & seals for both sides. Old king pins must be sent first. **\$450.00/kit**
- 526845** 1950 Commander. Less gaskets..... **\$201.00/kit**
- *529057** 1951-52 car all models..... **\$395.00/kit**
Refundable core charge. **\$200.00 core**
- *800331** 1961-66 car, all models except 1961 Hawk & 1963-85 Avanti. Includes rebuilt king pins (2) with new upper and lower sleeves, all bearings, bushings, shims & seals for both sides..... **\$700.00/kit**
Refundable core charge*. **\$600.00 core**
- 1553352** 1953-1960 car, all models & 1961 Hawk..... **\$395.00/kit**

TRUCK



- 674533X1** Early M5 bearing & bushings only. No pins. **\$45.00/kit**
- 674534** 1941-48. M15, early 15A. **\$68.00/kit**
- 674535** 1941-55 M16, M17 & 2R-E 16, 17, 28, 38..... **\$96.25/kit**
- 676587** Late M15A & 1949-54 2R & 3R 14, 15, E14, 7E & 8E 13, 15 **\$95.00/kit**
- 678171** (Pictured) Late M5 1949-64, 2R-2E 5, 7, 10-12, 3E-6E 1-3, 5-7, 3E-4E 10-12, 7E-8E 5, 7. **\$155.00/kit**
- 684492** 1955-61 E & 2E 13, 14, 15, 3E & 4E 10, 11, 12, 13, 14, 5E & 6E 13, 14 **\$94.60/kit**
- 684493** 1955-64 E-6E 16, 17, 28, 38, 7E & 8E 25, 28,35..... **\$110.00/kit**
- 1692875** 5E and 6E 10, 11, 12. 7E 10, 11. Pictured, above..... **\$289.95/kit**
- 1689073** 7E and 8E 40, 45 with standard front axle..... **\$93.50/kit**

***NOTE: Invoice must be included with core for a refund.**

PRE-WAR STEERING GEAR

Twin Lever Type late 1936-46

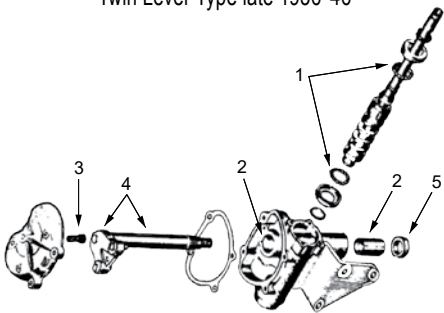

- (1) **G145641** Ball bearing. 1936-1946 all models..... **\$6.25 set/25**
- (2) **680211** Sector shaft bushing. 1939-46 Champion. Takes 2..... **\$11.00 ea.**
- (2) **680212** Sector shaft bushing. 1936-42 Dictator & Commander. Takes 2..... **\$12.50 ea.**
- (3) **190277** Screw, adjusting. 1937-40 all except Champion **\$4.95 ea.**
- (4) **198436** Sector shaft. 1940-42 Commander. **\$105.00 ea.**
- (5) **190276** Oil seal. 1937-42 President..... **\$17.50 ea.**
- (5) **197106** Oil seal. 1939-46 Champion..... **\$12.75 ea.**
- (5) **523010** Oil seal. 1936-39 car. Except President & Champion **\$16.50 ea.**
- (5) **1694898** Oil seal. 1940-42 Commander. **\$20.90 ea.**

PRE-WAR STEERING GEAR

Pitman Arm & Adapter



- (1) **197801** Arm with studs. 1939-40 Champion **\$38.50 ea.**
- (1) **199394** Arm with studs. 1941-46 Champion **\$45.00 ea.**
- (2) **198123** Arm. 1939-40 Commander & President. **\$46.20 ea.**
- (3) **190260** Arm. Late 1936 Dictator 4A & 1937 Dictator 6A..... **\$44.00 ea.**
- (4) **191968** Arm. 1938 Commander & Coupe Express..... **\$42.35 ea.**
- (5) **197787** Adapter. 1939-46 Champion..... **\$19.25 ea.**
- (6) **198127** Adapter & studs. 1940-42 Commander **\$38.60 ea.**
- (7) **197789** Insulator. 1940-42 Commander, President & 1939-46 Champion. Takes 4. **\$6.00 ea.**

NOTE: For pre-war steering parts not listed, please inquire as to price & availability. Part numbers must be furnished.

STEERING GEAR Models 14A, 15A, 16A, 1947-49 Commander

- (2) **196821** Nut..... **\$12.00 ea.**
- (4) **521742** Bearing. 1947-48..... **\$23.10 ea.**
- (4) **525662** Bearing. 1949..... **\$23.10 ea.**
- (5) **515548** Cover..... **\$17.05 ea.**
- (7) **189143** Gasket..... **\$3.00 ea.**
- (8) **189144** Shim. .003..... **\$2.20 ea.**
- (8) **189145** Shim. .010..... **\$2.20 ea.**
- (9) **G114496** Nut..... **\$1.20 ea.**
- (10) **G103865** Plug..... **\$1.75 ea.**
- (11) **520883** Screw..... **\$3.30 ea.**
- (12) **525907** Cover..... **\$15.80 ea.**
- (13) **198441** Gasket..... **\$5.50 ea.**
- (14) **521192** Sector shaft..... **\$138.60 ea.**

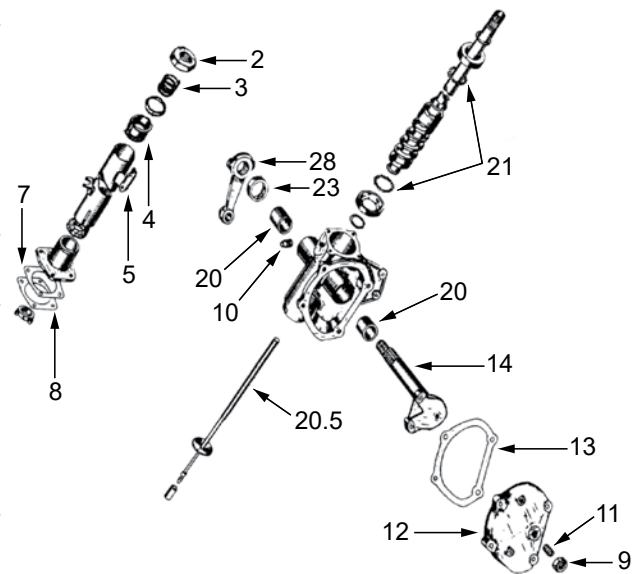

- (20) **680212** Bushing. Takes 2... **\$12.50 ea.**
- (21) **G145641** Ball..... **\$6.25 set/25**
- (23) **523036** Seal. Early 1947..... **\$11.00 ea.**
- (23) **517091** Seal. Late 1947-1950..... **\$20.90 ea.**
- (28) **521071** Arm..... **\$31.35 ea.**

STEERING GEAR Models 6G, 7G, 8G 1947-49 Champion

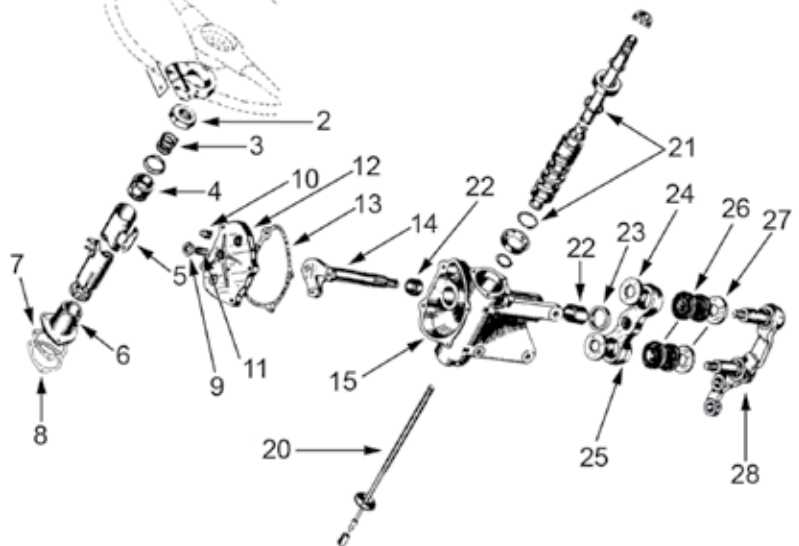

- (2) **196821** Nut. All models..... **\$12.00 ea.**
- (4) **521742** Bearing. All models.. **\$23.10 ea.**
- (5) **515548** Cover. All models..... **\$17.05 ea.**
- (6) **521979** Cover. All models..... **\$13.20 ea.**
- (7) **197108** Gasket. All models..... **\$2.00 ea.**
- (8) **197109** Shim, (.003)..... **\$1.20 ea.**
- (9) **G272121** Nut..... **\$1.65 ea.**
- (10) **G103865** Plug..... **\$1.75 ea.**
- (11) **197042** Screw..... **\$4.95 ea.**
- (12) **522632** Cover..... **\$13.70 ea.**
- (13) **521095** Gasket..... **\$3.30 ea.**
- (14) **521092** Shaft..... **\$104.50 ea.**
- (15) **521093** Housing..... **\$100.00 ea.**
- (21) **G145641** Ball..... **\$6.25 set/25**
- (22) **680211** Bushing. Takes 2..... **\$11.00 ea.**
- (23) **197106** Seal..... **\$12.75 ea.**
- (24) **523208** Upper washer. Takes 2..... **\$2.00 ea.**
- (25) **519245** Adapter..... **\$26.00 ea.**
- (26) **519627** Bushing. Takes 2..... **\$9.20 ea.**
- (27) **523207** Lower washer. Takes 2..... **\$2.00 ea.**
- (28) **519244** Arm..... **\$85.80 ea.**

STEERING GEAR Model 9G 1950 Champion

- (2) **196821** Nut..... \$12.00 ea.
- (4) **521742** Bearing. Champion with standard trans..... \$23.10 ea.
- (4) **525662** Bearing. Champion with automatic trans..... \$23.10 ea.
- (7) **197108** Gasket..... \$2.00 ea.
- (8) **197109** Shim, (.003) ... \$1.20 ea.
- (9) **G272121** Nut..... \$1.65 ea.
- (10) **G103865** Plug..... \$1.75 ea.
- (11) **197042** Screw..... \$4.95 ea.
- (12) **527052** Cover..... \$24.20 ea.
- (13) **679255** Gasket..... \$4.95 ea.
- (14) **527048** Sector shaft..... \$155.00 ea.
- (16) **527022** Housing..... \$104.50 ea.
- (21) **G145641** Ball..... \$6.25 set/25
- (22) **680210** Bushing. Requires modification. Takes 2..... \$22.00 ea.

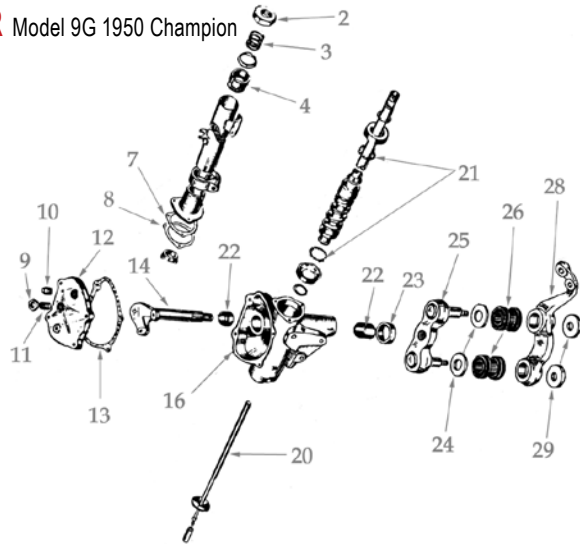

- (23) **679257** Seal..... \$12.60 ea.
- (24) **523207** Upper washer. Takes 2..... \$2.00 ea.
- (25) **526291** Adapter..... \$46.20 ea.
- (26) **519627** Bushing. Takes 2..... \$9.20 ea.
- (28) **526288** Arm..... \$46.20 ea.
- (29) **523208** Lower washer. Takes 2..... \$2.00 ea.

TYPE "S" STEERING

1951-56 Car & 1957 Champion w/3-spoke wheel

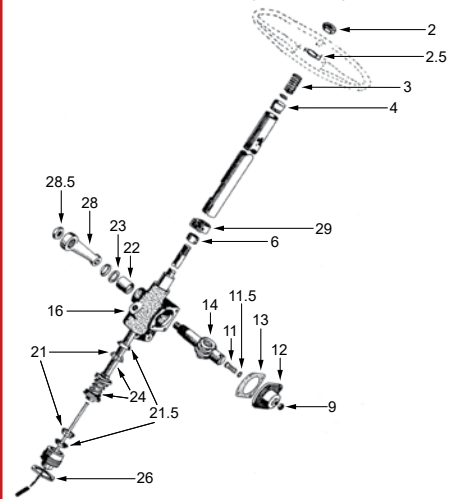

- (2) **196821** Nut. All models..... \$12.00 ea.
- (2.5) **534451** Lock. 1953-57..... \$4.95 ea.
- (3) **534227** Spring. 1953-57..... \$2.60 ea.
- (4) **521742** Bearing. 1951 custom before serial #1,111,6111..... \$23.10 ea.
- (4) **525662** Bearing. Late 1951 custom & all other 1951-52 car..... \$23.10 ea.
- (9) **G272121** Nut..... \$1.65 ea.
- (11) **531149** Screw. All models..... \$10.45 ea.
- (11.5) **531150X1** .063 shim..... \$4.95 ea.
- (11.5) **531150X2** .065 shim..... \$4.95 ea.
- (11.5) **531150X3** .067 shim..... \$4.95 ea.
- (11.5) **531150X4** .069 shim..... \$4.95 ea.
- * (12) **531144** Cover. Includes bearing..... \$51.80
- (13) **531147** Gasket..... \$5.90 ea.
- (14) **531148** Shaft. All models..... \$150.00 ea.
- (16) **532580** Housing. All models..... \$70.50 ea.
- (22) **531140** Bushing. All models. Substitute 680209 & modify..... \$20.50 ea.
- (23) **531351** Seal. All models..... \$7.70 ea.
- (24) Steering shaft..... Call for Availability
- (26) **531121** Lock nut. All models..... \$7.70 ea.
- (28) **531136** Arm. 1951-52..... \$63.35 ea.
- (28) **532526** Arm. 1953-57 except C & K..... \$41.80 ea.
- (28.5) **510746** Nut..... \$4.95 ea.
- (29) **532885P** Clamp. All models..... \$4.95 ea.

* 680209 Bushing can also be used to replace the bushing in your old cover.

STEERING GEAR Model 17A 1950 Commander & Land Cruiser

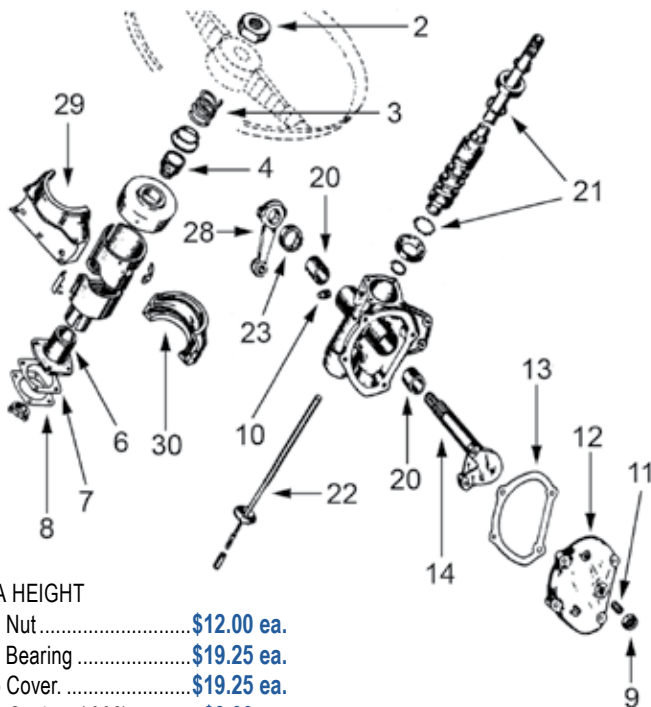

*FOR EXTRA HEIGHT

- (2) **196821** Nut..... \$12.00 ea.
- (4) **525662** Bearing..... \$19.25 ea.
- (6) **527413** Cover..... \$19.25 ea.
- (7) **189143** Gasket, (.002)..... \$3.00 ea.
- (8) **189144** Shim, (.003)..... \$2.20 ea.
- (8) **189145** Shim, (.010)..... \$2.20 ea.
- (9) **G114496** Nut..... \$1.20 ea.
- (10) **G103865** Plug..... \$1.75 ea.
- (11) **520883** Screw..... \$3.30 ea.
- (12) **525907** Cover..... \$15.80 ea.
- (13) **189133** Gasket..... \$4.95 ea.
- (14) **521192** Shaft..... \$138.50 ea.
- (20) **680212** Bushing. Takes 2..... \$12.50 ea.
- (21) **G145641** Ball..... \$6.25 set/25
- (23) **1694898** Seal..... \$20.90 ea.
- (28) **526103** Arm..... \$37.60 ea.
- (29) **291590** Bracket. Chrome..... \$71.50 ea.
- (29) **291060*** Bracket. Chrome..... \$71.50 ea.
- (30) **291059** Bracket. Chrome..... \$71.50 ea.

STANDARD STEERING GEAR Type SL 1957-64

- (1) **3091X2** Nut..... \$3.85 ea. \$71.50 ea.
- (2) **1550908** Bearing. 1960 & all 1961-64 with type-C shift lever support..... \$19.25 ea. \$71.50 ea.
- (3) **1541967** Bracket with bearing. 1957-59 car & 1960. with type -B shift lever support..... \$43.45 ea.
- (3) **1550904** Bracket with bearing. 1960 car with type-C shift lever support..... \$43.45 ea.
- (3) **1553319** Bracket with bearing. All 1961-64 car..... \$63.25 ea.
- (4) Call for Availability & price
- (5) **532885P** Clamp. All models.... \$4.95 ea.
- (6) **532994P** Bracket. 1957-60 all models, 1961-64 Hawk..... \$12.50 ea.
- (7) **189143** Gasket. All models. Brass..... \$3.00 ea.
- (8) **189144** Shim, (.003). all models. \$2.20 ea.
- (8) **189145** Shim, (.010). all models..... \$2.20 ea.
- (9) **1542673** Post. 1957-64 Hawk..... \$150.00 ea.
- (10) **1542662** Housing. 1958-60 V-8 Lark & sedan and 1960 6-cylinder convertible.....
- (10) **1542663** Housing. 1957-64 Hawk. \$71.50 ea.
- 11) **G444734** Plug. All models \$1.10 ea.
- (12) **1541938** Arm. 1957-60 V-8 all models, 1959 6-cylinder Hawk & convertible. 1553208 arm, 1961 6-cylinder Lark..... \$42.35 ea.
- (12) **1551387** Arm. 1961-64 Hawk..... \$42.35 ea.
- (14) **190276** Seal. All models. \$17.50 ea.
- (15) **680209** Bushing. All models. Requires modification. Takes 2..... \$16.50 ea.
- (16) **1543133** Sector shaft. All models. Includes stud. & rollers \$126.50 ea.
- (17) **1542670** Gasket. All models. \$4.95 ea.
- (18) **1542669** Cover. All models. \$31.35 ea.
- (19) **630651** Screw. All models..... \$2.20 ea.
- (20) **G124934** Nut..... \$1.10 ea.
- (21) **1543135** Stud & roller kit.... \$75.00 ea.
- 1541790** Complete Steering Gear for 1957-64 Hawk. Numbers 9 through 22. \$650.00 ea.

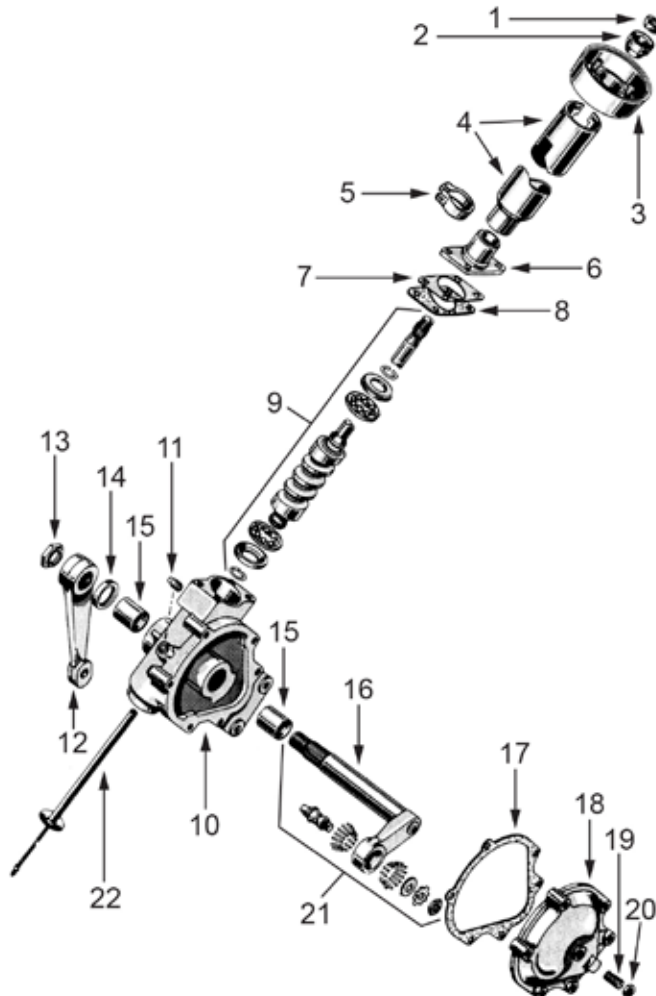

STEERING GEAR

Types: TA-TL, "TA" used in 1951-54 Car "TL" used in 1951-56 Car, All & 1957-58 Champion

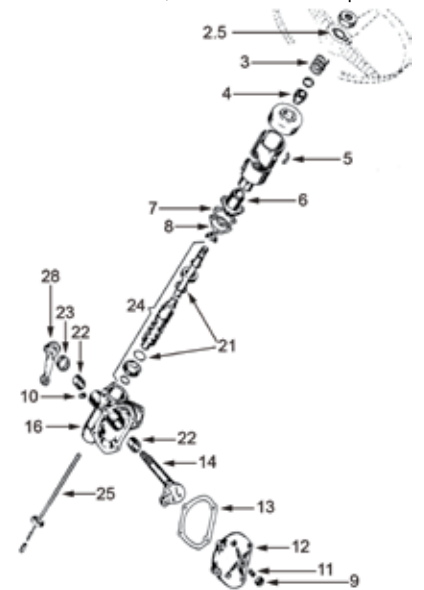

- (2.5) **534451** Lock plate. 1953-58..... \$4.95 ea.
- (3) **534227** Spring. 1953-58..... \$2.60 ea.
- (4) **521742** Bearing. 1951 customs before serial #G1,111,611..... \$23.10 ea.
- (4) **525662** Bearing. 1951 customs after serial #G1,111,611 & all other 1951-52 car.... \$23.10 ea.
- (5) **515548** Cover. 1951 custom before serial #G1,111,611..... \$17.05 ea.
- (5) **530062P** Cover. Late 1951 custom & all other 1951-52 car..... \$6.60 ea.
- (6) **532473** Flange. 1953-58. \$13.20 ea.
- (7) **197108** Gasket. All models..... \$2.00 ea.
- (8) **197109** .003 shim. All models..... \$1.20 ea.
- (9) **G272121** Nut. TA \$1.65 ea.
- (9) **G114496** Nut. TL..... \$1.20 ea.
- (11) **197042** TA screw for 530902 shaft. \$4.95 ea.
- (11) **630651** TL screw for 532273 shaft..... \$2.20 ea.
- (12) **530912** Cover. TA. 1951-54. all models \$29.00 ea.
- (12) **530914** Cover. TL. 1951-54. All models. ... \$28.05 ea.
- (13) **679255** Gasket. TA. 1951-54 \$4.95 ea.
- (13) **530916** Gasket. TL. 1951-58..... \$4.50 ea.
- (14) **530902** Shaft. TA. 1951-54. Champion except C & K..... \$112.20 ea.
- (14) **532273** Shaft. TL. 1951 all models, 1952 Commander & '53-'58 all models '53 & '54 Champion C & K only..... \$114.00 ea.
- (21) **G145641** Ball, set of 25. All models. \$6.25 set/25
- (22) **680210** Bushing, all models. Requires modification. Takes 2..... \$22.00 ea.
- (23) **679257** Seal, all models \$12.60 ea.
- (24) Steering shaft Call
- (25) **530907** Cover & tube, TL box only. 1951-58..... \$10.45 ea.
- (28) **529327** Arm. TA & TL. 1951-52. \$38.50 ea.

STANDARD STEERING GEAR Type S 1961-66 Lark

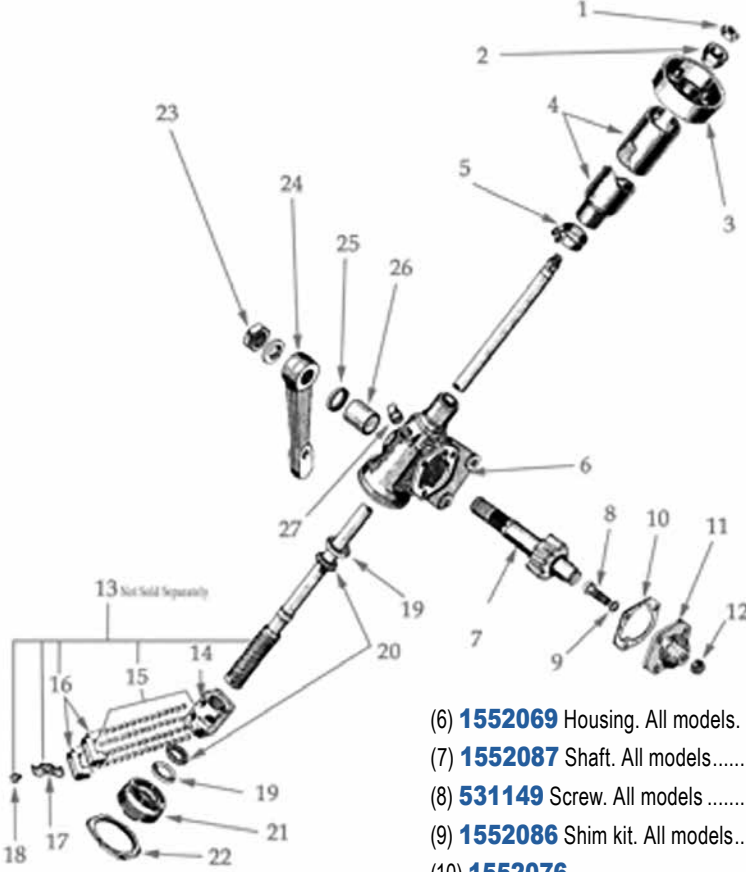

- (1) **3091X2** Nut.....\$3.85 ea.
- (2) **1550908** Bearing. All models...\$19.25 ea.
- (3) **1553319** Bracket. All models...\$63.25 ea.
- (4) Jacket.....CALL
- (5) **532885P** Bracket. All models....\$4.95 ea.

- (6) **1552069** Housing. All models...\$71.50 ea.
- (7) **1552087** Shaft. All models.....\$93.50 ea.
- (8) **531149** Screw. All models.....\$10.45 ea.
- (9) **1552086** Shim kit. All models...\$10.45 ea.
- (10) **1552076**.....\$4.80 ea.
- (11) **1552075** Cover with bushing...\$27.50 ea.
- (12) **G272121** Nut.....\$1.65 ea.
- (13) **1552077** Shaft 20:1 ratio. 1961-66 6-cylinder with power steering.....\$170.00 ea.
- (13) **1552078** Shaft 24:1 ratio. 1961-66 V-8 w/o power steering.....\$86.75 ea.

- (14) **1552079** Ball nut goes with 1552077 shaft 20:1 ratio.....\$55.00 ea.
- (14) **1552080** Ball nut goes with 1552078 shaft 24:1 ratio.....\$46.20 ea.
- (15) **1552496** Ball set. All models...\$27.50 ea.
- (16) **1552082** Guide goes with 1552078 shaft 24:1 ratio. Takes 4.....\$3.30 ea.
- (17) **1552084** Clamp. 1961-66 V-8 without power steering.....\$4.95 ea.
- (18) **G187385** Screw. 1961-66 6-cylinder & 1961-66 V-8 with power steering.....60¢ ea.
- (18) **1552085** Screw. 1961-66 V-8 without power steering.....\$4.95 ea.
- (19) **1552072** Thrust bearing. All models except early 1961 V-8. Takes 2.....\$7.95 ea.
- (20) **1552073** Cup, thrust bearing. 1961-66 All models except early 1961 V-8. Takes 2.....\$13.20 ea.
- (21) **1565140** Adjuster. 1961-66 All models except early 1961 V-8.....\$33.00 ea.
- (22) **1552071** Adjuster nut. All models.....\$7.70 ea.
- (23) **1553103** Nut. All models.....\$7.70 ea.
- (24) **1553208** Pitman arm. 1961-64 V-8 except sliding roof wagon.....\$42.35 ea.
- (24) **1551387** 1961-64 V-8 convertible & 1963-64 sliding roof wagon.....\$42.35 ea.
- (25) **1552088** Seal. All models.....\$11.25 ea.
- (26) **531140** Bushing. All models. Substitute 680209 & modify.....\$20.50 ea.
- (27) **G444746** Plug. All models.....\$2.75 ea.

STEERING LINKAGE Models 14A, 15A, 16A, 1947-49 Commander

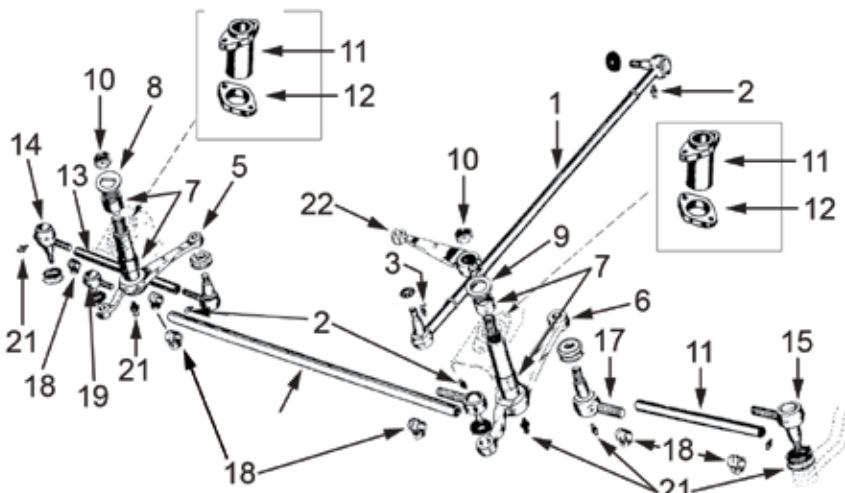

- (1) **520115** Drag Link. 1947-49 All...\$52.00 ea.
- (2) **718-04** (G110347) Grease fitting \$1.95 ea.
- (3) **738-04** (G110309) Grease fitting...\$2.75 ea.
- (5) **519110** Bellcrank. Right.....\$100.50 ea.

- (6) **519111** Bellcrank. Left. Not perfect... Call
- (7) **518390** Bearing. Takes 4.....\$23.10 ea.
- (8) **184808** Thrust washer.....\$4.95 ea.
- (9) **519470** Thrust washer.....\$11.55 ea.

- (10) **260-12** (G6427639) Nut.....\$6.60 ea.
- (11) **522523** Bracket. Includes 2 #518390 BRGS.....\$64.00 ea.
- (12) **522492** Collar.....\$19.80 ea.
- (13) **518904** Rod.....\$22.00 ea.
- (14) **520110** End, outer right tie rod.....Substitute 520111
- (15) **520111** End, outer left tie rod...\$90.00 ea.
- (16) **520112** End, inner right tie rod.....\$45.00 ea.
- (17) **520113** End, inner left tie rod...\$45.00 ea.
- (18) **510487** Clamp, less bolt and nut.....\$4.40 ea.
- (19) **520345** Auxiliary rod end. Right.....\$38.00 ea.
- (20) **520346** Auxiliary rod end. Left.....\$45.00 ea.
- (21) **716-02** (G443753) Grease fitting.....\$1.65 ea.
- (22) **521070** Lever.....\$51.60 ea.

TIE RODS & RELATED PARTS 1940-42 Commander & President & Late 1940-46 Champion

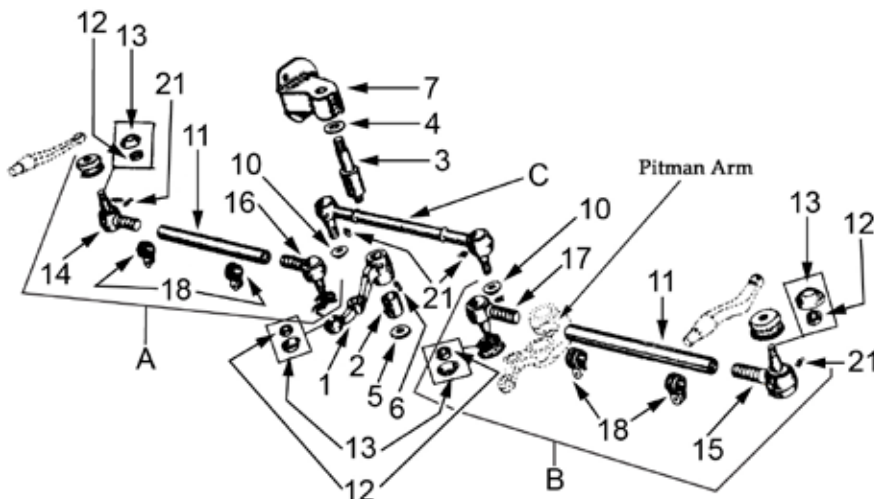

- (1) **197918** Idler arm. 1940 all except Champion **\$28.00 ea.**
Note: Order 196591 washer also at \$2.50.
- (1) **198074** Idler arm. Late 1940 Champion **\$32.00 ea.**
- (1) **513502** Idler arm. 1941-46 Champion all models **\$22.00 ea.**
- (1) **513508** Idler arm. 1941 Commander, late 1941 President & all 1942 cars except Champion **\$24.00 ea.**
- (1) **513519** Idler arm. 1941 Commander and early 1941 President. Sub 513508 arm & one 513504 shaft **\$22.00 ea.**
- (2) **196592** Bushing, idler arm. 1940 all car except Champion **\$9.90 ea.**
- (2) **198076** Bushing, idler arm. Early 1941 Commander, late 1940 Champion & all 1941 Champion **\$5.50 ea.**
- (3) **197426** Pin. 1940 all cars except Champion **\$9.90 ea.**
- (3) **198077** Shaft. Late 1940 Champion, early 1941 Champion & early 1941 Commander **\$14.30 ea.**
- (3) **513504** Shaft. Late 1941 Commander & President, 1942 Commander & President all, late 1941 Champion & all 1942-46 Champion **\$33.00 ea.**

- 513505** Bushing, idler arm. Late 1941-42 Commander, 1941-46 Champion and 1939-40 Champion with type A auxiliary arm kit **\$22.00 ea.**
- (4) **195275** Thrust washer. 1940 all except Champion **\$3.30 ea.**
- (4) **198078** Thrust washer. All 1941-46 car. ... **\$3.30 ea.**
- (5) **198079** Thrust washer. 1941-46 cars all models **\$3.85 ea.**
- (6) **G191350** Grease fitting. All 1939-46 Champion **\$2.65 ea.**
- (7) **197924** Bracket. 1940 Commander & President **\$44.00 ea.**
- (7) **199861** Bracket. 1941-46 all **\$27.50 ea.**
- (A) **513301** Left, tie rod assembly, complete. 1941-42 all except Champion **\$135.00 ea.**
- (A) **513450** Tie rod assembly, complete. Right side. 1940 all except Champion **\$109.50 ea.**
- (A & B) **198180** Tie rod assembly, complete. Right or left side, 1940-46 Champion **\$125.00 ea.**
- (B) **513302** Tie rod assembly, complete. Left side. 1941-42 all except Champion **\$135.00 ea.**
- (B) **513451** Tie rod assembly, complete. Left side. 1940 all except Champion **\$109.50 ea.**

- (C) **198579** Tie rod and ends. 1940-42 all except Champion **\$65.00 ea.**
- (C) **198588** Tie rod and ends. 1941-46 Champion **\$75.00 ea.**
- (11) **198020** Rod only. 1940 Commander **\$24.75 ea.**
- (11) **198082** Rod only. 1940-46 Champion **\$22.00 ea.**
- (11) **198258** Rod only. 1941-42 all except Champion **\$27.50 ea.**
- (12) **194373** Rubber seal or washer. 1940-46 Champion **\$3.50 ea.**
- (13) Cover **Not Available**
- (14) **520112** Tie rod end, outer right. 1940-42 all except Champion **\$45.00 ea.**
- (15) **520113** Tie rod end, outer left. 1940-42 all except Champion **\$45.00 ea.**
- (14 & 15) **199207** End, right or left outer. 1940-46 Champion **\$40.00 ea.**
- (16) **520110** Tie rod end, inner right. 1940-42 all except Champion **Substitute 520111**
- (17) **520111** Tie rod end, inner left. 1940-42 all except Champion **\$90.00 ea.**
- (16 & 17) **199208** End, right or left inner. 1940-46 Champion **\$80.00 ea.**
- (18) **510487** Clamp. 1940-42 all except Champion **\$4.40 ea.**
- (21) **G109350** Grease fitting. 1940-42 all except Champion **\$1.95 ea.**
- (21) **G110347** Grease fitting. 1941-42 all except Champion **\$1.95 ea.**
- (21) **G191350** Grease fitting. All 1939-46 Champion **\$2.65 ea.**
- (21) **G443753** Grease fitting. Straight. 1940-42 all except Champion **\$1.65 ea.**

TIE ROD & RELATED PARTS 1938 All Cars & Early 1939 Commander

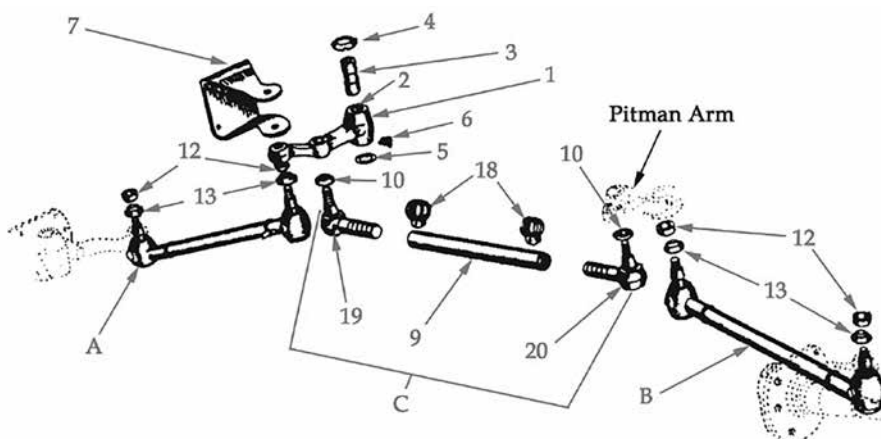

- (1) **191833** Arm with bushing. 1938 all & early 1939 Commander **\$32.00 ea.**
- (2) **516768** Auxiliary arm bushing. 1938 all & very early 1939 cars **\$13.20 ea.**

- (2) **193884** Bushing. Early 1939 Commander **\$14.30 ea.**
- (3) **191804** Pin. 1938 all & early 1939 cars **\$13.20 ea.**

- (4) **191805** Washer, upper. 1938 all & early 1939 **\$4.40 ea.**
- (5) **191806** Washer, lower. 1938 all & early 1939 **\$4.40 ea.**
- (7) **191971** Bracket. All **\$44.00 ea.**
- (A) **193383** Rod with ends, right. 1938-39 all **\$275.00 ea.**
- (B) **193384** Rod with ends, left. 1938-39 all **\$75.00 ea.**
- (C) **193134** Rod with ends. 1938-39 all **\$103.80 ea.**
- ((18) **510487** Clamp. 1938-39 all. Takes 2 **\$4.40 ea.**
- (19) **520345** End, complete. Right side. 1938-39 all **\$38.00 ea.**
- (20) **520346** End, complete. Left side. 1938-39 all **\$45.00 ea.**

TIE ROD & RELATED PARTS 1939 All (Except Early 1939 Commander & Early 1940 Champion)

NOTE: Some 1939 & Early 1940 Champions Have Been Updated to 1941 & Later Standards. These Cars Will Require Later Parts.

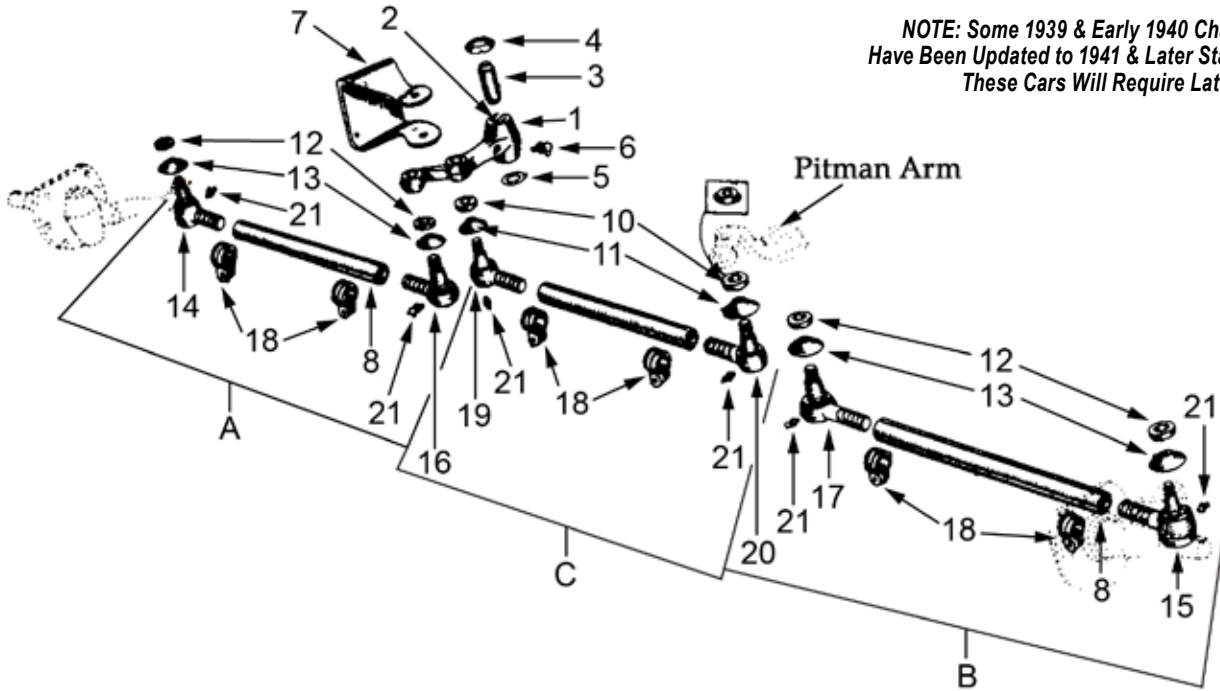

(1) **196593** Arm with bushing. Late 1939 Commander, Coupe Express, all, & President...
.....**\$28.00 ea.**

Note: Order 196591 washer also at \$2.50.

(1) **197650** Arm with bushing. Early 1939 Champion, & 1940 Champion, all**\$24.00 ea.**

(2) **196592** Bushing. Late 1939 car all except Champion**\$9.90 ea.**

(2) **197654** Bushing. 1939 Champion all & early 1940 Champion.....**\$4.95 ea.**

(3) **197426** Pin. Late 1939 Commander & 1939 President & Coupe Express all
.....**\$9.90 ea.**

(3) **195208** Pins. Early 1939 Champion.....
.....**\$110.00 ea.**

(3) **197655** Pin. Late 1939 Champion & early 1940 Champion.....**\$21.95 ea.**

(4) **196591** Washer. Late 1939 Commander & 1939 President & Coupe Express all ..**\$3.85 ea.**

(4) **197385** Washer. 1939 Champion all & early 1940 Champion.....**\$3.30 ea.**

(5) **195275** Washer. 1939 car all models except Champion**\$3.30 ea.**

(5) **195211** Washer. 1939 Champion all & early 1940 Champion.....**\$3.85 ea.**

(6) **G191350** Grease fitting. 1939-46 Champion, 1941-42 Commander & President.**\$2.65 ea.**

(7) **197736** Bracket Kit. Late 1939 Commander, 1939 President & Coupe Express all. Includes small parts.....**\$60.50 ea.**

(7) **199861** Bracket. 1939-40 Champion all ...
.....**\$27.50 ea.**

(A) **513446** Tie rod & ends. Right side. Late 1939 Commander, 1939 President & Coupe Express all.....**\$115.00 ea.**

(B) **513447** Tie rod & ends. Left side. Late 1939 Commander, all 1939 President & Coupe Express.....**\$115.00 ea.**

(A & B) **198180** Tie rod, with ends. 1939-46 Champion all. Takes 2.....**\$125.00 ea.**

(8) **198082** Rod only. 1939-40 Champion all.....
.....**\$22.00 ea.**

(10) **194373** Seal, auxiliary tie rod end. 1939-40 Champion all. Takes 2.....**\$3.50 ea.**

(11) **197090** Cover, ball stud, 1939-40 Champion all. Takes 2.....**Call**

(11) **193831** Cover, ball stud. Late 1939 Commander, 1939 President & Coupe Express all. Takes 2.....**Call**

(13) **193831** Cover, ball stud. Late 1939 Commander, 1939 President & Coupe Express all. Takes 4.....**Call**

(13) **197090** Cover, ball stud. 1939-40 Champion all. Takes 4.....**Call**

(14) **520112** Tie rod end. Outer right. Late 1939 Commander, 1939 President & Coupe Express all.....**\$45.00 ea.**

(15) **520113** Tie rod end. Outer left. Late 1939 Commander, 1939 President & Coupe Express all.....**\$45.00 ea.**

(14 & 15) **199207** End. Right & left outer. Champion 1939-40 all**\$40.00 ea.**

(16) **520110** Tie rod end. Inner right. Late 1939 Commander, 1939 President & Coupe Express all.....**Substitute 520111**

(17) **520111** Tie rod end. Inner left. Late 1939 Commander, 1939 President & Coupe Express all.....**\$90.00 ea.**

(16 & 17) **199208** End. Right & left inner. 1939-40 Champion all.....**\$80.00 ea.**

(18) **510487** Clamp. Late 1939 Commander, all 1939 President & Coupe Express. **\$4.40 ea.**

(C) **193134** Auxiliary tie rod assembly with ends. 1939 all cars except Champion.....
.....**\$103.80 ea.**

(C) **197157** Rod, includes ends. 1939 Champion & early 1940 Champion**\$95.00 ea.**

(C) **198588** Rod, includes ends. Late 1940 Champion.**\$75.00 ea.**

(19) **520345** End, right auxiliary. 1939 all cars

except Champion.....**\$38.00 ea.**

(20) **520346** End, left auxiliary. 1939 all cars except Champion.....**\$45.00 ea.**

(19) **199207** End, right auxiliary. Early 1939-40 Champion.**\$40.00 ea.**

(20) **199208** End, left auxiliary. Early 1939-40 Champion**\$80.00 ea.**

(21) **G109350** Fitting. 67-1/2°. All except Champion.**\$1.95 ea.**

(21) **G443753** Fitting. Straight. All except Champion**\$1.65 ea.**

(21) **G191358** Fitting. 1939-40 Champion.
.....**\$2.65 ea.**

FRONT AXLE - STEERING KNUCKLE, CONTROL ARMS & KING PINS

1936-37 Dictator & President Models 4A, 6A - 2C, 3C. **Pictured on next page at bottom.**

(1) **S-336X1** Bushing & bearing kit. Less pins, shims & gaskets. Enough for both sides.
.....**\$80.00 ea.**

(3) **510869** Bushing. 1937 Dictator 6A & all 1936-37 Presidents. Takes 4**\$12.00 ea.**

(4) **171513** .051 - .054 shim. All.**\$2.20 ea.**

(5) **165010** Bearing. All. Takes 2...**\$14.80 ea.**

(6) **510141** Key. All. Takes 2**\$7.65 ea.**

(8) **191679** Pin. All. Takes 2**\$32.00 ea.**

(9) **185792** Bushing. All. Takes 4. **\$28.00 ea.**

(10) **G443753** Grease fitting. Takes 2.....
.....**\$1.65 ea.**

(11) **130986** Washer. All. Takes 2....**\$4.50 ea.**

(12) **1543223** Nut. 1936-37 Dictator & 1937 President.**\$6.60 ea.**

DRIVESHAFT CENTER SUPPORT Individual Pieces & Complete Kits

**1947-49 Cars - All Models & 1950
Champion**
(Early Canadian Production)

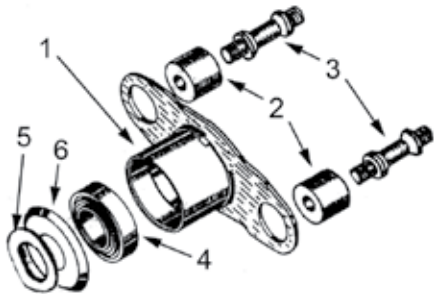

- (1) **519171** Support \$24.00 ea.
- (2) **519175** Support cushion. Takes 2. \$7.50 ea.
- (3) **524184** Support stud. Takes 2.... \$26.40 ea.
- (4) **517450** Bearing \$56.15 ea.
- (5) **519176** Dust shield \$6.00 ea.

Driveshaft Center Support Kit

Includes all of the following:

- (1) **519171** Support (1)
- (2) **519175** Support cushion (2)
- (3) **524184** Support stud (2)
- (4) **517450** Bearing (1)
- (5) **519176** Dust shield (1)

Total of all parts if purchased separately.....
..... \$127.00

801823
Special Kit Price \$121.00/kit

Please use your customer number when ordering. Found on the upper left hand corner of the address label on this catalog.

1950 all Models
(Except Early Canadian-Built Champions)

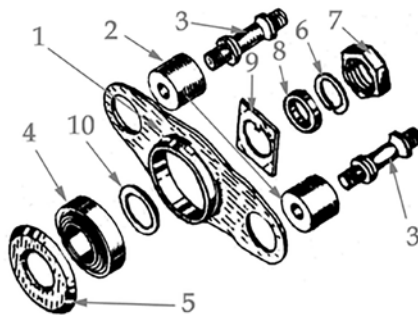

- (1) **526842** Support \$23.00 ea.
- (2) **519175** Support cushion. Takes 2. \$7.50 ea.
- (3) **524184** Support stud. Takes 2... \$26.40 ea.
- (4) **664443** Bearing. \$46.50 ea.
- (5) **523000** Dust shield..... \$6.00 ea.
- (6) **522051** Nut \$7.55 ea.
- (7) **522054** Retainer \$3.00 ea.
- (8) **522053** Washer No Stock
- (9) **522052** Lock plate. No Stock
- (10) **527024** Space..... No Stock

Driveshaft Center Support Kit

Includes all of the following:

- (1) **526842** Support (1)
- (2) **519175** Support cushion (2)
- (3) **524184** Support stud (2)
- (4) **664443** Bearing (1)
- (5) **523000** Dust shield (1)
- (6) **522051** Nut (1)
- (7) **522054** Retainer.
- (9) **522052** Lock plate. No stock (0)
- (10) **527024** Spacer. No stock (0)

Total of all parts if purchased separately.....
..... \$138.05

801825
Special Kit Price \$131.00/kit

1951-57 Cars

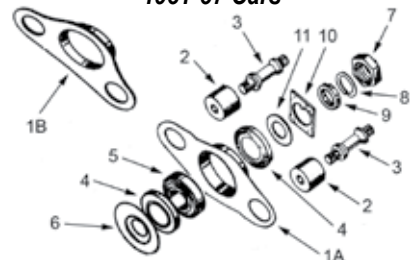

- (1A) **531746** Support, 1951-52 all... \$27.60 ea.
- (1B) **532009** Support, 1953-57 all... \$27.60 ea.
- (2) **519175** Support cushion. Takes 2. \$7.50 ea.
- (3) **524184** Support stud. Takes 2... \$26.40 ea.
- (4) **531016** Dust shield, inner. Takes 2 \$4.35 ea.
- (5) **664443** Bearing, drive shaft support \$46.50 ea.
- (6) **530421** Dust shield, outer \$4.35 ea.
- (7) **522051** Nut..... \$7.55 ea.
- (8) **522054** Retainer \$3.00 ea.
- (9) **522053** Washer..... No Stock
- (10) **522052** Lock plate..... No Stock
- (11) **527024** Spacer..... No Stock

Driveshaft Center Support Kit

Includes all of the following (A or B):

- (1A) **531746** Support, 1951-52 (1)
- or (1B) **532009** Support, 1953-57 (1)
- (2) **519175** Support cushion (2)
- (3) **524184** Support stud (2)
- (4) **531016** Dust shield, inner (2)
- (5) **664443** Bearing, drive shaft support (1)
- (6) **530421** Dust shield, outer (1)
- (7) **522051** Nut (1)
- (8) **522054** Retainer
- (10) **522052** Lock plate. No stock (0)
- (11) **527024** Spacer. No stock (0)

Total of all parts if purchased separately.....
..... \$145.10

801824
Special Kit Price \$138.00/kit

FRONT AXLE - STEERING KNUCKLE, CONTROL ARMS, & KING PINS

1936-37 Dictator & President Models 4A, 6A-2C, 3C

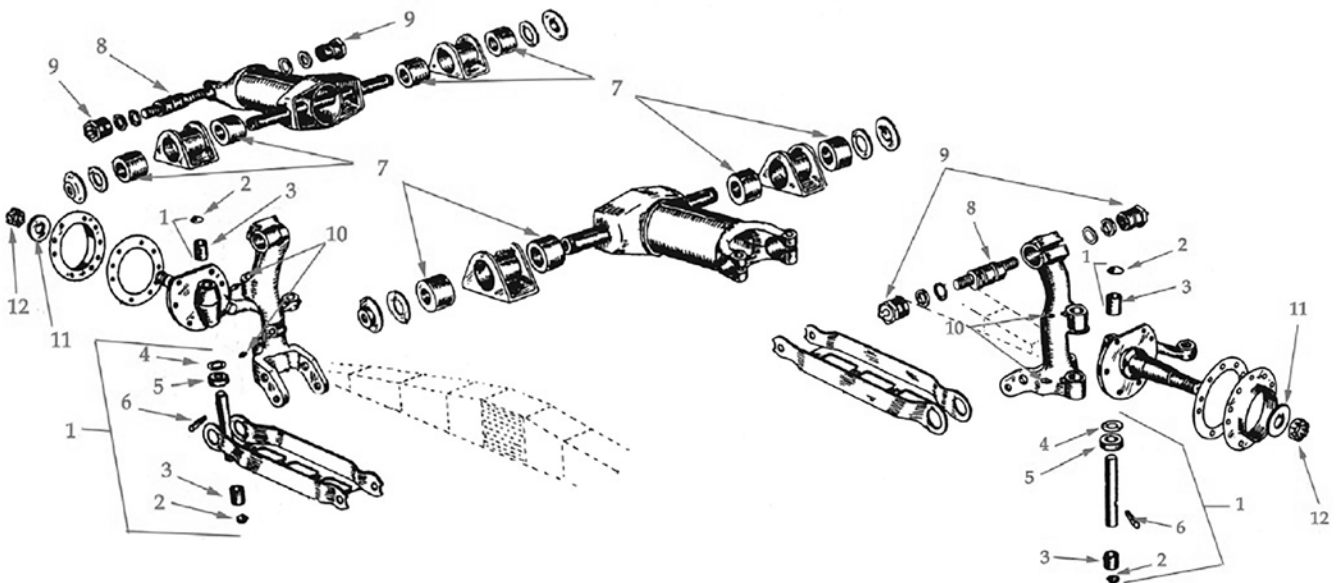

FRONT AXLE & STEERING 1934-37 Dictator & Coupe Express Models A, 1A, 3A, 5A & J-5

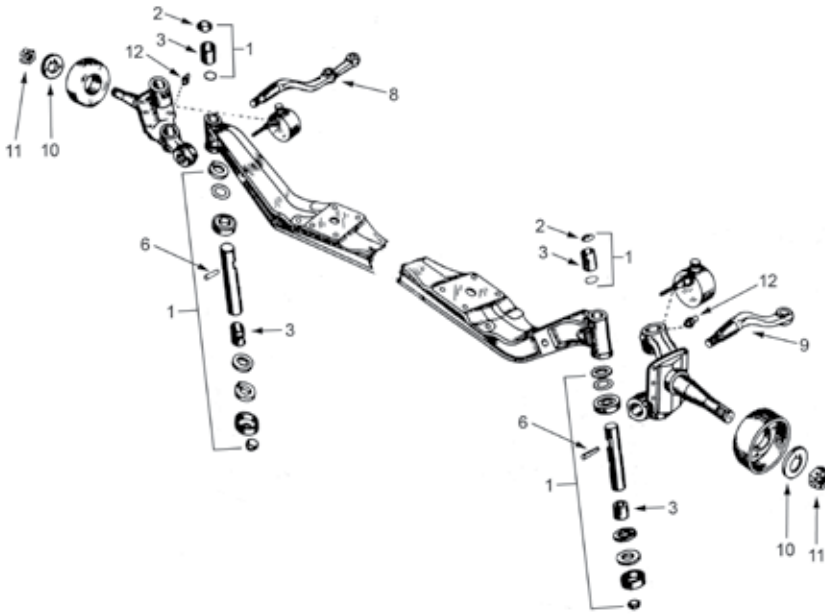

- (1) **S-335X1** Bushing & bearing kit. Less pins, gaskets, keys & most shims. Fits 1934-37 models A, 1A, 3A, 5A & J-5 **\$80.00 ea.**
- (2) **510144** Welch plug. Upper. Takes 2 **\$1.65 ea.**
- (3) **510869** Bushing. Takes 4 **\$12.00 ea.**
- (4) **170513** Shim, (.053) **\$2.20 ea.**
- (5) **165010** Bearing. Takes 2 **\$14.80 ea.**
- (6) **510141** Key. Takes 2 **\$7.65 ea.**
- (7) **510145** Welch plug, lower. Takes 2 **\$1.65 ea.**
- (8) **183080** Arm. Right side. Limited availability. Fits 1A, 3A, 5A & J-5 **\$42.00 ea.**
- (9) **511126** Arm. Left side. Limited availability. Fits Model "A" **\$42.00 ea.**
- (9) **511216** Arm. Left side. Limited availability. Fits 1A, 3A, 5A & J-5 **\$42.00 ea.**
- (10) **130986** Washer. Takes 2 **\$4.50 ea.**
- (11) **1543223** Nut. Takes 2 **\$6.60 ea.**
- (12) **G443753** Grease fitting. Takes 2 **\$1.65 ea.**

FRONT AXLE 1949-61 1/2 Ton and 3/4 Ton Truck

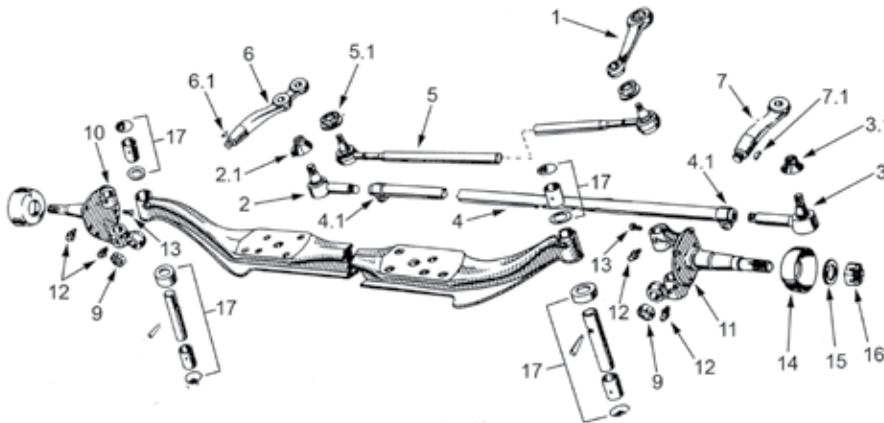

- (1) **676751** Arm. 2R5 & early 2R10 with T12 steering box **\$40.15 ea.**
- (1) **678670** Arm. 2R5 & late 2R10 with T12 steering box **\$40.15 ea.**
- (1) **679258** Arm. 2R5 & early 2R10, 3R 5, 10 & II, 3E 1,5, & 10 all with TA12 steering box. **\$42.35 ea.**
- (1) **679614** Arm. 2R5 & late 2R10, 2R6, 2R11, 3R - 2E 6,7,11, & 12, 3E 2, 3,6,7,11 & 12, all with TA12 steering box. **\$71.50 ea.**
- (1) **680651** Arm. 2R5, 6, 10 & 11 with S-type steering gear **\$42.35 ea.**
- (2) **666193** Tie rod end. Right. 2R-6E all **\$38.00 ea.**
- (3) **666194** Tie rod end. Left. 2R-6E all **\$49.50 ea.**
- (2.1 & 3.1) **530202** Rubber boot, tie rod end. 2R-6E all **\$2.50 ea.**
- (4) **676692** Tie rod. Rod only. 2R5 - 2R10 (early) 48 3/4" long **\$71.50 ea.**
- (4) **684147** Tie rod, rod only. 3E & 4E models 10,11,12 with heavy duty front axle **Call**
- (4.1) **510487** Clamp. Tie rod. 2R-6E all models. Takes 2 **\$4.40 ea.**
- (5) **1689408** Reach rod or drag link. Includes ends. 2R-4E all models **\$250.00 ea.**
- (5) **520111** End. Reach rod or drag link. Left hand thread. Has leather cover used on early version of drag link with removable ends. 2R-2E all models. Takes 2 **\$90.00 ea.**
- (5) **1689384** End. Reach rod or drag link. Right hand thread. 3E-6E all models. Takes 2 **\$42.60 ea.**
- (6) **676696** Arm. Right steering knuckle. 2R5 & early 2R10 **\$91.30 ea.**
- (6) **678668** Arm. Right steering knuckle. 2R5 & late 2R10 and all 2R6, 2R11 and 2R12 trucks. Also 3R-4E all models except 4E 10, 11, & 12 with heavy duty front axle. Used on 5E & 6E models 5, 6, 7. **\$82.50 ea.**
- (6) **684144** Arm. Right steering knuckle. 3E & 4E 10, 11,12 with heavy duty axle. Also 5E, 6E, 10, 11, 12 all **\$95.50 ea.**
- (7) **678672** Arm. Left steering knuckle. 2R5 & late 2R10 and all 2R6, 2R11 and 2R12 trucks. Also 3R-4E all models except 4E 10, 11, & 12 with heavy duty front axle. Used on 5E & 6E models 5, 6, 7. **\$82.50 ea.**
- (6) **684145** Arm. Left steering knuckle. 3E & 4E 10, 11,12 with heavy duty axle. Also 5E, 6E, 10,11,12 all **\$94.60 ea.**
- (6.1 & 7.1) **G106751** Key. 2R-4E all models except 3E & 4E 10,11, and 12 with heavy duty front axle. Also used on 5E-6E 5, 6, 7 (Takes 2) .. **No Stock**
- (6.1 & 7.1) **7X34** Feather key. 3E & 4E 10, 11, 12 with heavy duty front axle & 5E and 6E 10, 11, 12 all **No Stock**
- (9) **1543223** Nut, steering knuckle arm. 2R-4E all except 3E & 4E 10, 11, 12 with heavy duty front axle also used on 5E & 6E 10, 11, 12 all **\$6.60 ea.**
- (9) **684146** Nut, steering knuckle arm. 3E & 4E 10, 11, 12 with heavy duty front axle and all 5E & 6E 10, 11, 12 **\$7.70 ea.**
- (10) **677604** Steering knuckle. Right. 2R Early 2E all models late 2 E- 6E all models 1-7 only **Call**
- (10) **1685860** Steering knuckle. Right. Late 2E & all 3E and 4E 10,11,12 with standard front axle **\$148.50 ea.**
- (10) **684134** Steering knuckle. Right. 3E & 4E 10,11,12 with heavy duty front axle **\$160.25 ea.**
- (11) **677605** Steering knuckle. Left. 2R-early 2E all models late 2 E- 6E all models 1-7 only **Call**
- (11) **1685861** Steering knuckle. Left. Late 2E & all 3E and 4E 10,11,12 with standard front axle **\$148.50 ea.**
- (11) **684135** Steering knuckle. Left. 3E & 4E 10,11,12 with heavy duty front axle **\$162.80 ea.**
- (12) Grease fitting **No Stock**
- (13) **G102895** Set screw. 2R-4E all except 3E & 4E 10,11,12 with heavy duty front axle. Also used on 5E & 6E models 1-7. Takes 2 **\$1.10 ea.**
- (14) **191202** Oil slinger. 2R-6E models 1-7 (Takes 2) **\$9.20 ea.**
- (15) **130986** Washer, with tang. 2R-2E all models except late 2E 10,11,12. Also used on 3E-6E 1,2,3,5,6,7. Takes 2 **\$4.50 ea.**
- (16) **1543223** Nut, front wheel bearing. 2R-6E all **\$6.60 ea.**
- (17) **678171** King pin kit. 2R-6E all except 5E & 6E models 10, 11, 12 **\$74.00/kit**
- (17) **1692875** King pin kit. 5E & 6E models 10, 11, 12 **\$239.00/kit**

FRONT AXLE MODEL M5

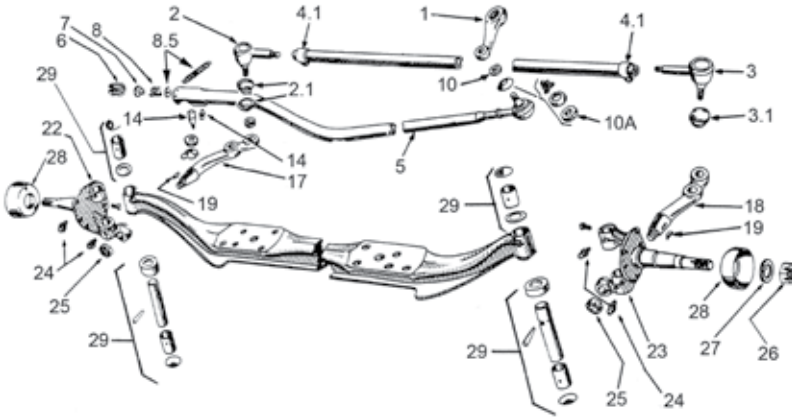

FRONT AXLE MODEL M15 TYPICAL

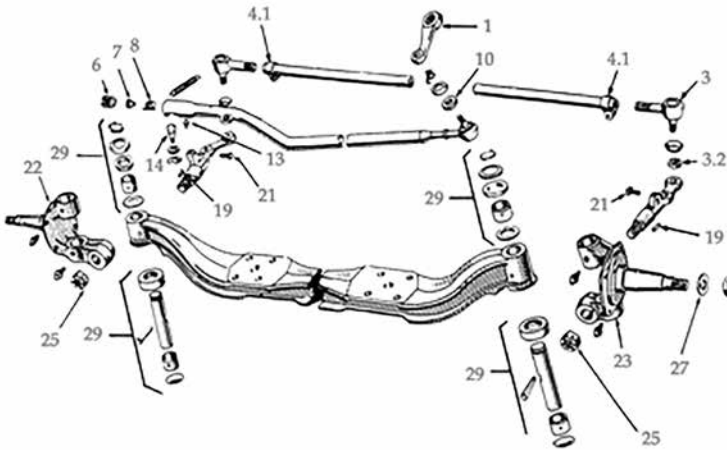

FRONT AXLE, STEERING KNUCKLE & LINKAGE Models M16, M17

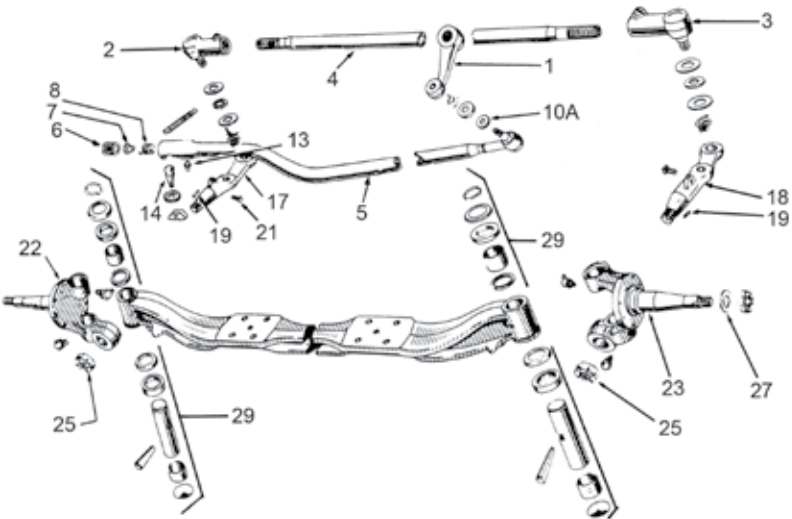

- (1) **665015** Pitman arm. M15, M15A, M16, M17 all models **\$31.25 ea.**
- (1) **676413** Pitman arm. M5's on and after service #M5-3238..... **\$38.50 ea.**
- (2) **664824** Tie rod end, right. M16 & M17 all **\$94.00 ea.**
- (2) **666193** Tie rod end, right. M5 all..... **\$38.00 ea.**
- (2) **666292** Tie rod end, right. M15 & M15A. All **\$40.00 ea.**
- (3) **666007** Tie rod end, left. M16 & M17 all..... **\$45.00 ea.**
- (3) **666194** Tie rod end, left. M5 all. **\$49.50 ea.**

- (2) **666293** Tie rod end, left. M15 & M15A all ... **\$45.00 ea.**
- (2-3.1) **530202** Cover, tie rod end. Rubber. M5, M15, M15A all. **\$2.50 ea.**
- (4.1) **665309** Clamp. M5, M15, M15A all models. **\$5.50 ea.**
- (5) **666252** Drag link or reach rod. M5's prior to Serial #M5-3238 **\$75.00 ea.**
- (5) **666822** Drag link or reach rod. M5's on and after serial #M5-3238 **No Stock**
- (6) **511252** Plug. All **Call**
- (7) **511255** Seat, reach rod axle end. All. **\$3.63 ea.**

- (10A) **185048** Washer. M5 on and after service #M5-3238, M15, 15A, 16, 17 all. **\$3.30 ea.**
- (13) **G191758** Grease fitting. All. **\$3.30 ea.**
- (14) **631884** Ball stud. All models..... **\$75.00 ea.**
- (17) **665295** Arm, right. M5, all..... **\$47.50 ea.**
- (17) **666013** Arm, right. M16 & M17 all **\$94.60 ea.**
- (18) **665296** Arm, left. M5's all **Call**
- (18) **666014** Arm, left. M16 & M17 all **\$94.60 ea.**
- (19) **G124549** Key. All. Takes 2. **\$2.75 ea.**
- (19) **630836** Key. M15, 15A, 16, 17 all. Takes 2. **\$2.20 ea.**
- (20) **1543223** Nut. M5 all. Takes 2..... **\$6.60 ea.**
- (20) **630724** Nut. M15, M15A, M16, M17 all. Takes 2. **\$10.45 ea.**
- (21) **630845** Stop screw. M15, 15A, 16, 17. Takes 2 **\$7.70 ea.**
- (22) **665291** Knuckle & bushings, right. M5 original equipment casting #100368 .. **\$151.80 ea.**
- (22) **666009** Knuckle & bushings, right. M16 & M17 all **\$154.00 ea.**
- (22) **666277** Knuckle & bushings, right. M15 prior to serial #M15-2001 **Call**
- (22) **673626** Knuckle & bushings, right. M15 after service #M15-2001 & M15A's prior to serial #M15A-14,482 **\$151.80 ea.**
- (22) **676553** Knuckle & bushings, right. M15A after Serial #M15A-14,482 **\$193.50 ea.**
- (22) **677604** Knuckle & bushings, right. M5 replacement casting #102512 **Call**
- (23) **665292** Knuckle & bushings, left. M5 original equipment, casting #100368 **Call**
- (23) **666010** Knuckle & bushings, left. M16 & M17 all **\$154.00 ea.**
- (23) **673627** Knuckle & bushings, left. M15's after serial #M15-2001 & M15A's prior to Serial #M15A-14,482 **\$151.80 ea.**
- (23) **676554** Knuckle & bushings, left. M15A's after Serial #M15A-14,482 **\$193.50 ea.**
- (23) **677605** Knuckle & bushings, left. M5 replacement, casting #102512 **Call**
- (25) **1543223** Nut. M5 all. Takes 2..... **\$6.60 ea.**
- (25) **630724** Nut. M15, 15A, 16, 17 all. Takes 2. **\$10.45 ea.**
- (26) **1543223** Nut. M5 all. Takes 2..... **\$6.60 ea.**
- (27) **130986** Lock washer. All. Takes 2..... **\$4.50 ea.**
- (28) **191202** Oil slinger. M5 all. Takes 2. **\$9.20 ea.**
- (29) **674533X1** King pin kit, bushings and bearings only. M5's with steering knuckles having forging #100368..... **\$45.00 ea.**
- (29) **674534** King pin kit. M15's and early M15A's. **\$68.00 ea.**
- (29) **674535** King pin kit. M16 & M17 all. **\$90.50 ea.**
- (29) **676587** King pin kit. M15A's after Serial #M15A-14,482..... **\$95.00 ea.**
- (29) **678171** King pin kit. M5's with replacement steering knuckles having forging #102512 **\$74.00 ea.**

FRONT AXLE - STEERING KNUCKLE, CONTROL ARMS & KING PINS

Model 9A Before Car Serials: South Bend - 4,112,701 & Los Angeles - 4,803,802 1938 All Cars & Early 1939 Commander - 9A

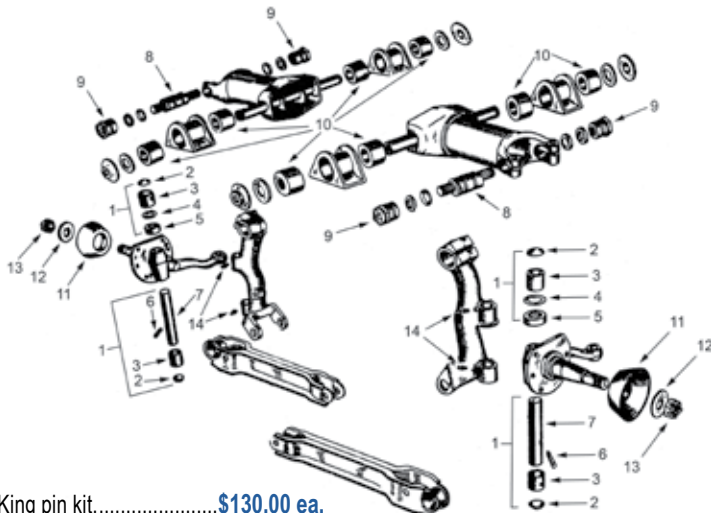

- (1) **S-333** King pin kit.....\$130.00 ea.
- (1) **S-333X1** Bushing & bearing set only. Less pins, keys, shims, & welch plugs.....\$80.00 ea.

- (3) **510869** Bushing. Takes 4.....\$12.00 ea.

- (4) **181647** Shim.. Available in S-333 kit only.
- (5) **165010** Thrust bearing. All. Takes 2.....\$14.80 ea.
- (6) **510141** Key. Also available in king pin kit. Takes 2.....\$7.65 ea.
- (7) **191135-6** King pins.....
Order S-333 Complete king pin kit
- (8) **191679** Pin. All. Takes 2.....\$32.00 ea.
- (9) **185792** Bushing. All. Takes 4.....\$28.00 ea.
- (11) **191202** Slinger. All. Takes 2.....\$9.20 ea.
- (12) **130986** Washer. All. Takes 2.....\$4.50 ea.
- (13) **1543223** Nut. All. Takes 2.....\$6.60 ea.
- (14) **G443753** Grease fitting. All. Takes 4.....\$1.65 ea.

FRONT AXLE STEERING

1962 (7E) Truck and 7E & 8E (1962-64) Models 13, 15, 25, 35, 40, 45

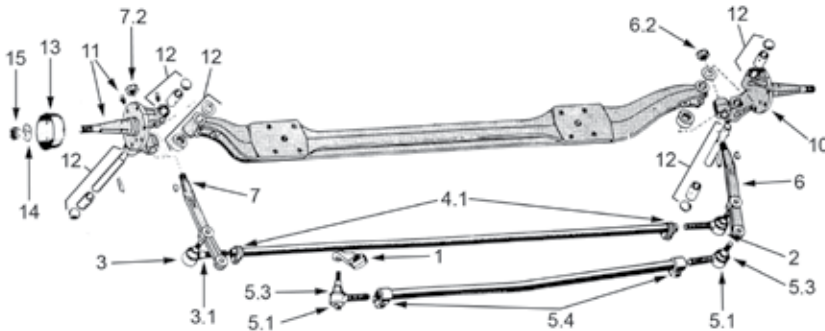

- (1) **679274** Pitman arm. 7E 13.....\$52.80 ea.
- (1) **679276** Pitman arm. 7E & 8E 25, 28, 35, 40, 45..... Call
- (1) **1696518** Pitman arm. 8E 13,15.....\$52.80 ea.
- (2) **684163** Tie rod end, right. 7E & 8E, 25, 28, 35, 40, 45.....\$55.00 ea.
- (2) **666193** Tie rod end, right. 7E 5, 7 and 7E & 8E, 10,12,13,15.....\$38.00 ea.
- (2) **684164** Tie rod end, left. 7E & 8E, 25, 28, 35, 40, 45.....\$55.00 ea.
- (2) **666194** Tie rod end, left. 7E 5, 7 and 7E & 8E, 10,12,13,15.....\$49.50 ea.
- (2.1-3.1) **530202** Tie rod rubber boot. 7E 5 & 7 all, 7E-8E 10,12,13,15. Takes 2.....\$2.50 ea.
- (4) **684159** Tie rod. Rod only. 7E-8E 25, 28, 35, also 40 & 45 with standard front axle.....\$82.50 ea.
- (4) **1692580** Tie rod. Rod only. 7E 10 & 12.....\$52.80 ea.
- (4.1) **510487** Clamp. 7E-8E 5, 7, 10, 11, 13, 15. Takes 2.....\$4.40 ea.
- (4.1) **684162** Clamp. 7E-8E 25-45. Takes 2.....\$7.70 ea.
- (5.1) **1689384** Reach rod ends. 7E 5-15. Takes 2 on early 7E 5, 7, 10, 12, 13, 15 and takes only 1 on late 2E 5,7,10,12.....\$42.60 ea.
- (5.1) **1689389** Reach rod ends. 7E & 8E 25-45. Takes 2.....\$82.50 ea.
- (5.3) **530202** Reach rod end seal. 7E 5-15. Takes 2.....\$2.50 ea.
- (5.4) **1688227** Clamp, reach rod end. Early 7E 5,7,10,12. Also 7E-8E 13 & 15. Takes 2.....

-\$14.75 ea.
- (5.4) **1695664** Reach rod end clamp. Late 7E 5, 7, 10, 12. Takes 2.....\$7.70 ea.
- (6) **678668** Steering arm, right. 7E 5 & 7E 7.....\$82.50 ea.
- (6) **684144** Steering arm, right. 7E 10 & 12, 7E-8E 13 & 15.....\$95.50 ea.
- (6) **684160** Steering arm, right. 7E-8E 25, 28, 35.....\$95.50 ea.
- (6) **1688088** Steering arm, right. 7E-8E 40 & 45 with standard front axle.....\$44.60 ea.
- (6) **1691100** Steering arm, right. 7E-8E 40 & 45 with heavy duty axle.....\$115.50 ea.
- (7) **678669** Steering arm, left. 7E 5 & 7E 7.....\$82.50 ea.
- (7) **684145** Steering arm, left. 7E 10 & 12, 7E-8E 13 & 15.....\$94.60 ea.
- (7) **684161** Steering arm, right. 7E-8E 25, 28, 35.....\$94.60 ea.
- (7) **1688089** Steering arm, left. 7E-8E 40 & 45 with standard front axle.....\$93.50 ea.
- (7) **1691101** Steering arm, left. 7E-8E 40 & 45 with heavy duty axle.....\$115.50 ea.
- (6.2-7.2) **684146** Nut, arm hex. 7E-8E all except 5 & 7.....\$7.70 ea.
- (6.2-7.2) **1543223** Nut, arm hex. 7E 5 & 7.....\$8.55 ea.
- (10) **684134** Steering knuckle, right. 7E-8E 13 & 15.....\$160.25 ea.
- (10) **684150** Steering knuckle, right. 7E-8E 25, 28, 35.....\$177.00 ea.

- (10) **1688084** Steering knuckle, right. 7E-8E 40 & 45 with standard front axle.....\$242.00 ea.
- (10) **1692592** Steering knuckle, right. 7E 10 & 11.....\$225.50 ea.
- (11) **684135** Steering knuckle, left. 7E-8E 13 & 15.....\$162.80 ea.
- (10) **684151** Steering knuckle, left. 7E-8E 25, 28, 35.....\$177.00 ea.
- (10) **1691099** Steering knuckle, left. 7E-8E 40 & 45 with heavy duty front axle.....\$357.50 ea.
- (11) **1692593** Steering knuckle, left. 7E 11 & 12.....\$225.50 ea.
- (11) **1694611** Steering knuckle, left. 7E-8E 40 & 45 with air brakes.....\$302.50 ea.
- (12) **678171** King pin kit. 7E 5 & 7.....\$74.00 ea.
- (12) **684492** King pin kit. 7E-8E 13 & 15.....\$94.60 ea.
- (12) **684493** King pin kit. 7E-8E 25, 28, 35.....\$110.00 ea.
- (12) **1689073** King pin kit. 7E-8E 40 & 45 with standard front axle.....\$93.50 ea.
- (12) **1691096** King pin kit. 7E-8E 40 & 45 with heavy duty front axle..... Call
- (12) **1692875** King pin kit. 7E 10 & 11.....\$239.00 kit
- (13) **191202** Oil slinger. 7E 5 & 7. Takes 2.....\$9.20 ea.
- (14) **1539026** Lock washer. 7E-8E 5-35.....\$2.20 ea.
- (14) **1686179** Lock washer. 7E-8E 40 & 45 with standard front axle and less air brakes..\$7.70 ea.
- (14) **1691112** Lock washer. 7E-8E 40 & 45 with heavy duty front axle.....\$10.45 ea.
- (15) **1543223** Nut, front wheel bearing. All 7E-8E 5 through 35 having forging # embossed on front axle.....\$6.00 ea.
- (15) **1686180** Nut, front wheel bearing. 7E-8E 40 & 85 having forging # embossed on front axle. With standard axle & without air brakes..\$7.70 ea.
- (15) **1691111** Nut, front wheel bearing. All 7E-8E 40 & 45 having axle ID embossed on axle and having a heavy duty front axle.....\$9.50 ea.

FRONT AXLE Series 2R-6E Models 13, 14, 15

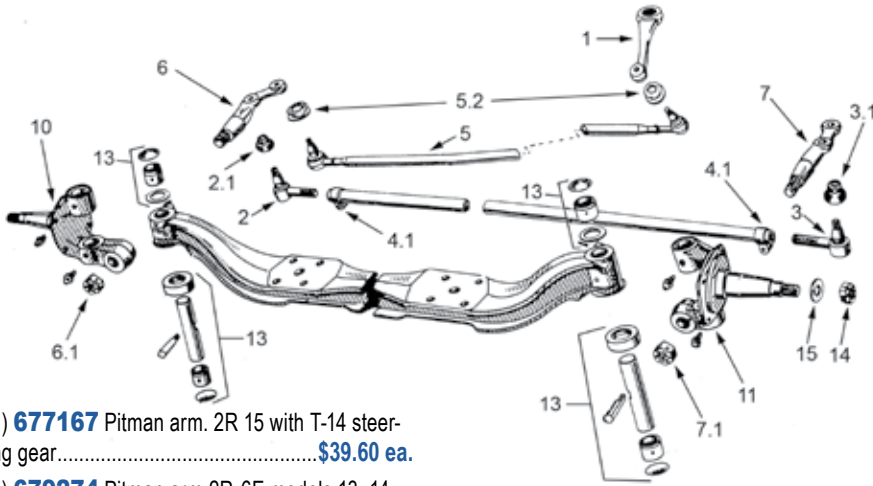

- (1) **677167** Pitman arm. 2R 15 with T-14 steering gear.....**\$39.60 ea.**
- (1) **679274** Pitman arm. 2R-6E models 13, 14, 15.....**\$52.80 ea**
- (2) **666193** Tie rod end, right. E-6E 13, 14, 15..
.....**\$38.00 ea.**
- (2) **666292** Tie rod end, right. 2R-3R 14 & 15 all
.....**\$40.00 ea.**
- (3) **666194** Tie rod end, left. E-6E 13, 14, 15
.....**\$49.50 ea.**
- (3) **666293** Tie rod end, left. 2R-3R 14 & 15 all.
.....**\$45.00 ea.**
- (2.1-3.1) **530202** Tie rod end rubber seal. All ...
.....**\$2.50 ea.**
- (4) **510487** Clamp. E-6E all.....**\$4.40 ea.**

- (4) **1688227** Clamp. 2R-3R 14 & 15 all.....
.....**\$14.75 ea.**
- (5) **1689408** Reach rod or drag link. Actually for the 1/2 ton & 3/4 ton but should work on these models also.....**\$250.00 ea.**
- (5.1) **520111** Drag link end. Left hand thread attaches to early version of drag link with replaceable ends 2R-6E all. Takes 2.....**\$90.00 ea.**
- (5.1) **1689384** Drag link end. Right hand thread attaches to later style rod with replaceable ends 2R-6E all. Takes 2.....**\$42.60 ea.**
- (5.2) **530202** Drag link end rubber seal. 2R-6E all. Takes 2.....**\$2.50 ea.**

- (6) **677162** Steering knuckle arm, right. 2R-3R 14 & 15.....**\$105.60 ea.**
- (6) **684144** Steering knuckle arm, right E-6E 13, 14, 15.....**\$95.50 ea.**
- (7) **677163** Steering knuckle arm, left. 2R-3R 14 & 15..... **Call**
- (6) **684145** Steering knuckle arm, left. E-6E 13, 14, 15.....**\$94.60 ea.**
- (6.1-7.1) **630724** Nut, arm hex. 2R-3R 14 & 15..
.....**\$10.45 ea.**
- (6.1-7.1) **684146** Nut, arm hex. E-6E 13, 14, 15.
.....**\$7.70 ea.**
- (10) **676553** Knuckle, right steering. 2R-3R 14 & 15.....**\$193.50 ea.**
- (10) **684144** Knuckle, right steering. E-6E 13, 14, 15.....**\$95.50 ea.**
- (11) **676554** Knuckle, left steering. 2R-3R 14 & 15.....**\$193.50 ea.**
- (11) **684135** Knuckle, left steering. E-6E 13, 14, 15.....**\$162.80 ea.**
- (13) **676587** King pin kit. 2R & 3R 14, 15.....
.....**\$95.00 ea.**
- (13) **684492** King pin kit. E & 6E 13, 14, 15.....
.....**\$94.60 ea.**
- (14) **1543223** Nut, front wheel bearing. E & 6E 13, 14, 15.....**\$6.60 ea.**
- (14) **165391** Nut. 2R & 3R 14,15. Also all E-series and some 2E trucks.....**\$4.50 ea.**
- (14) **130986** Nut, front wheel bearing. 2R & 3R 14, 15.....**\$4.50 ea.**
- (15) **1539026** Lock washer. Some 2E Series trucks and all 3E-6E.....**\$2.20 ea.**

FRONT AXLE STEERING KNUCKLE & LINKAGE

Model 8E 1963-64 1/2 Ton & 3/4 Ton Truck

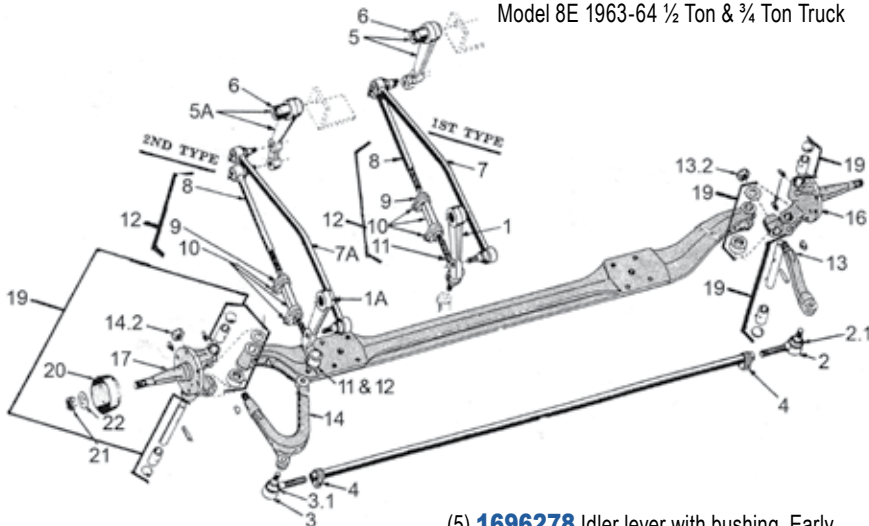

- (1) **1696293** Pitman arm. 8E 10 & 12 prior to Serial # E10-39,945 and E12-5,988.....**\$41.80 ea.**
- (1A) **1696293** Pitman arm. 8E 10 & 12 after Serial #E10-39,945 and #E12-5,988, also 8E 5 & 7 after Serial #E5-136,610 and E7-19,245.....
.....**\$41.80 ea.**
- (2) **1696862** Tie rod end, right.....**\$137.40 ea.**
- (3) **1696863** Tie rod end, left.....**\$85.00 ea.**
- (2.1-3.1) **530202** Rubber seal for tie rod end. Takes 2.....**\$2.50 ea.**
- (4) **510487** Clamp. 8E all.....**\$4.40 ea.**

- (5) **1696278** Idler lever with bushing. Early 8E 5,7,10,12. See Pitman arm for relevant serial numbers.....**\$69.10 ea.**
- (6) **1696946** Bushing. 8E all.....**\$15.00 ea.**
- (7) Rod with ends. 1st type..... **Call**
- (7A) **1697201** Rod with ends. 2 type. See Pitman arm for relevant serial numbers.....
.....**\$115.50 ea.**
- (8) **1697037** Reach rod end. Long...**\$66.00 ea.**
- (9) **1695664** Clamp. 8E all.....**\$7.70 ea.**
- (10) **1695663** Rod with clamps. 8E all.....
.....**\$31.30 ea.**

- (11) **1697036** Reach rod end. Short. 8E all.....
..... **Order complete assembly**
- (12) **1696563** Reach rod assembly. Includes both ends, rod, and 2 clamps. 8E all....**\$99.00 ea.**
- (13) **1696606** Steering knuckle arm, right. 8E 5 & 7 all.....**\$115.50 ea.**
- (13) **1696610** Steering knuckle arm, right. 8E 10 & 12 all.....**\$126.50 ea.**
- (13.2) **684146** Nut, arm hex. 8E 10 & 12 all. Takes 2.....**\$7.70 ea.**
- (13.2) **1543223** Nut, arm hex. 8E 5 & 7 all. Takes 2.....**\$6.00 ea.**
- (14) **1696607** Steering knuckle arm, left. 8E 5 & 7 all.....**\$115.50 ea.**
- (14) **1696611** Steering knuckle arm, left. 8E 10 & 12 all.....**\$225.50 ea.**
- (16) **1692592** Steering knuckle, right. 8E 10 & 12.....**\$225.50 ea.**
- (17) **1692593** Steering knuckle, left. 8E 10 & 12.....
.....**\$225.50 ea.**
- (19) **678171** King pin kit. 8E 5 & 7 all.....
.....**\$74.00 kit**
- (19) **1692875** King pin kit. 8E 10 & 12 all.....
.....**\$239.00 kit**
- (20) **191202** Oil slinger. 8E 5 & 7.....**\$9.20 ea.**
- (21) **1539026** Washer. 8E all.....**\$2.20 ea.**
- (22) **1543223** Nut. 8E all.....**\$6.00 ea.**

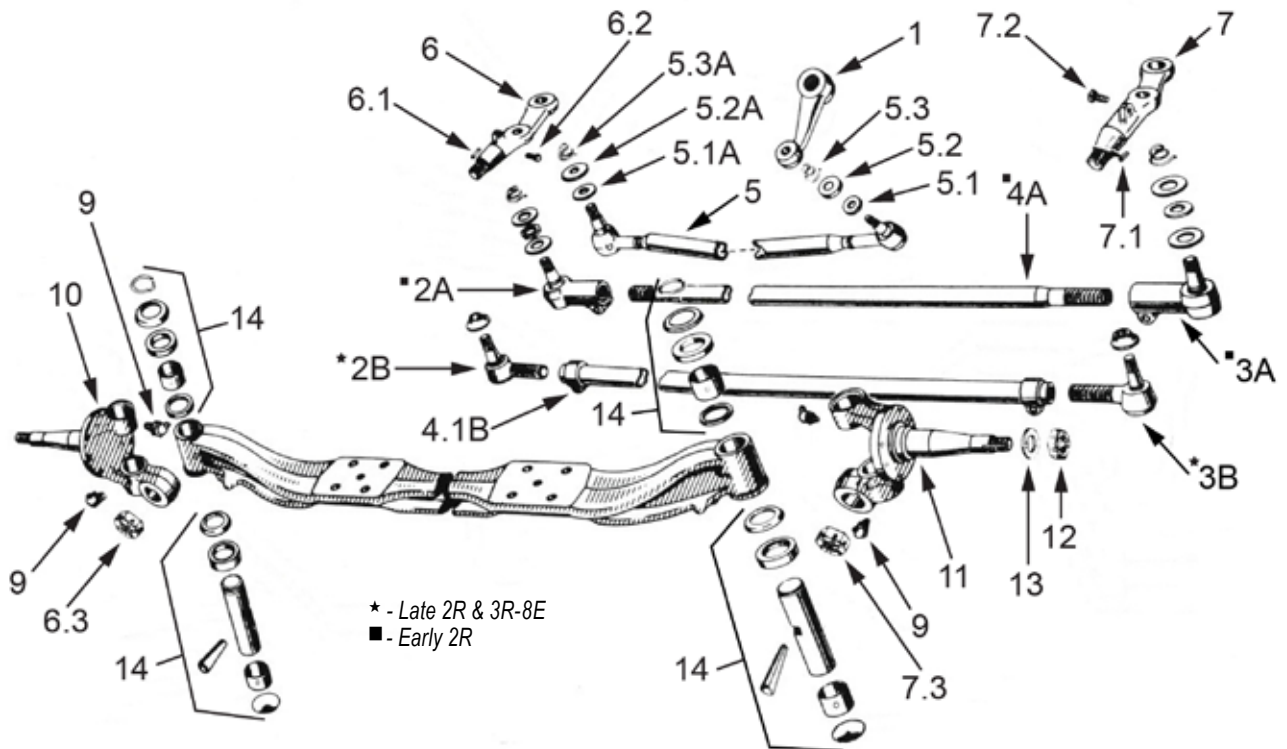

- (1) **676841** Pitman arm. Early 2R 16 & 17 with T-14 steering gear.....**\$41.80 ea.**
- (1) **679276** Pitman arm. Late 2R 16 & 17 and all 3R-6E trucks models 16-40..... **Call**
- (2A) **664824** Tie rod end, right. Early 2R 16 & 17.....**\$94.00 ea.**
- (2B) **678592** Tie rod end, right. Late 2R 16 & 17 and 2R-5E 28 & 38.....**\$55.00 ea.**
- (2B) **684163** Tie rod end, right. 2E 28 & 38-6E 16, 17, 28, 38, 40.....**\$55.00 ea.**
- (3A) **666007** Tie rod end, left. Early 2R 16 & 17.....**\$45.00 ea.**
- (3B) **678593** Tie rod end, left. Late 2R 16 & 17 and 2R-5E 28, 38.....**\$55.00 ea.**
- (3B) **684164** Tie rod end, left. 2E 28 & 38-6E 16, 17, 28, 38, 40.....**\$55.00 ea.**
- (4A) Rod. Early 2R 16 & 17..... **No Stock**
- (4B) **678594** Rod only. Late 2R 16 & 17 and all 3R-Series, E-series having front axle with forging #3100-Y-623.....**\$94.60 ea.**
- (4B) **684159** Rod only. E-series truck with front axle having forging #106479 1A & 2E all -6E.....**\$82.50 ea.**
- (4.1) **684162** Clamp. Late 2R and all 3R-6E trucks.....**\$7.70 ea.**
- (5) Drag link assembly..... **Call**
- (5.1) **681512** Drag link ends. 2R 16-2E 28 & 38 all.....**\$52.00 ea.**
- (5.1) **1689389** Drag link ends. 3E-6E 16-40.....**\$82.50 ea.**

- (6) **684160** Steering knuckle arm, right. E-series trucks having forging #1064791A and 2E-6E all except model 40.....**\$95.50 ea.**
- (6) **1688088** Steering knuckle arm, right. 3E-6E 40 with standard front axle.....**\$44.60 ea.**
- (6) **1691100** Steering knuckle arm, right. 4E-6E 40 with heavy duty front axle.....**\$115.50 ea.**
- (7) **684161** Steering knuckle arm, left. E Series trucks having forging #1064791A and 2E-6E all except model 40.....**\$94.60 ea.**
- (7) **1688089** Steering knuckle arm, left. 3E-6E 40 with standard front axle.....**\$93.50 ea.**
- (7) **1691101** Steering knuckle arm, left. 4E-6E 40 with heavy duty front axle.....**\$115.50 ea.**
- (6.1-7.1) **630836** Woodruff key. 2R & 3R all & early E-series having a front axle with forging #3100-Y-623.....**\$2.20 ea.**
- (6.3-7.3) **630724** Hex nut. 2R & 3R all and early E-Series having a front axle with forging #3100-Y-623.....**\$10.45 ea.**
- (6.3-7.3) **630724** Hex nut. 3E-6E all.....**\$10.45 ea.**
- (9) **G109350** Grease fitting. 2R-3R all & E-series with front axle having casting #3100-Y-623.....**\$1.95 ea.**
- (9) **G191758** Grease fitting. E-series with front axle having casting #106479AA A & all 2E's.....**\$3.30 ea.**
- (10) **666609** Steering knuckle, right. 2R-E Series models 16, 17, 28, 38.....**\$154.00 ea.**
- (10) **684150** Steering knuckle, right. 3E-6E 16, 17, 28, 38.....**\$177.00 ea.**

- (10) **1688084** Steering knuckle, right. 3E-6E model 40 with standard front axle.....**\$242.00 ea.**
- (10) **1691098** Steering knuckle, right. 4E-6E model 40 with heavy duty front axle..... **Call**
- (11) **666010** Steering knuckle, left. 2R-E Series models 16, 17, 28, 38.....**\$154.00 ea.**
- (11) **684151** Steering knuckle, left. 3E-6E 16, 17, 28, 38.....**\$177.00 ea.**
- (11) **1691099** Steering knuckle, left. 4E-6E model 40 with heavy duty front axle.....**\$357.50 ea.**
- (12) **1543223** Nut, wheel bearing lock E & 2E Series all and 3E-6E models 16-38.....**\$6.60 ea.**
- (12) **1686180** Nut, wheel bearing lock. 3E-6E 40 with standard axle.....**\$7.70 ea.**
- (13) **130986** Lock washer. 2R-E and some 2E models.....**\$4.50 ea.**
- (13) **1539026** Lock washer. Late 2E-Series.....**\$2.20 ea.**
- (13) **1686179** Lock washer. 3E-6E 40 with standard front axle.....**\$7.70 ea.**
- (13) **1691112** Lock washer. 4E-6E 40 with heavy duty front axle.....**\$10.45 ea.**
- (14) **674535** King pin kit. 2R-3R all and E-series having a front axle with forging #3100-Y-623.....**\$90.50 ea.**
- (14) **684493** King pin kit. E-series having a front axle with forging #106471A & all 2E-6E models 16-38.....**\$110.00 ea.**
- (14) **1689073** King pin kit. 3E-6E 40 with standard front axle.....**\$93.50 ea.**
- (14) **1691096** King pin kit. 4E-6E 40 with heavy duty front axle..... **Call**

"DANA" #23 OR #27 REAR AXLE 1955-66. Standard Differential only. "Twin Traction" parts are listed on page 280.

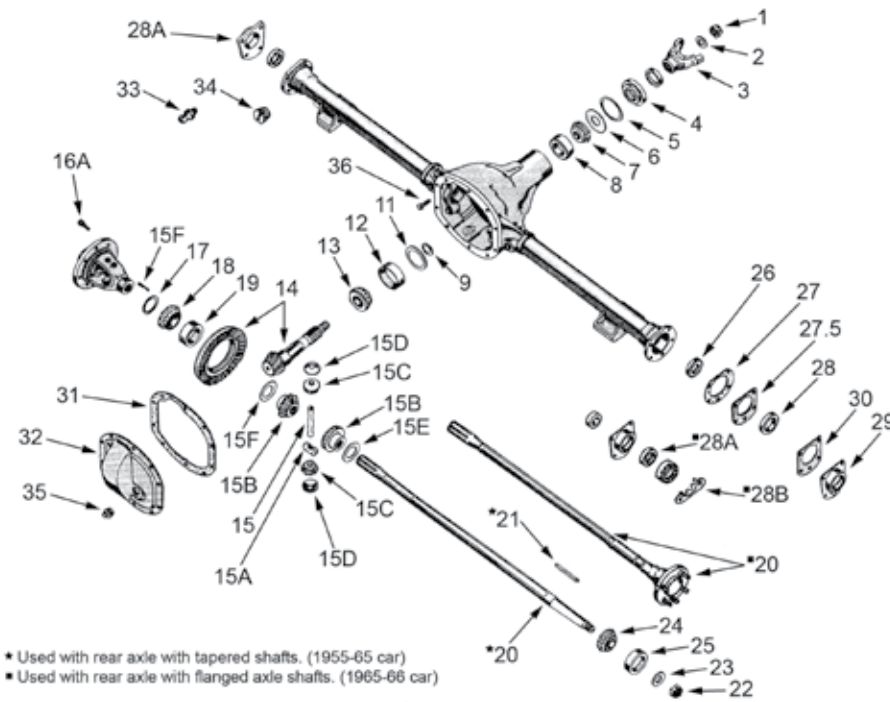

* Used with rear axle with tapered shafts. (1955-65 car)
 * Used with rear axle with flanged axle shafts. (1965-66 car)

- | | |
|--|---|
| (2) 196965 Washer. 1955-56 all models. | (15) 194835 Shaft. 1955-66 all models. |
|\$4.40 ea. |\$19.00 ea. |
| (3) 521825 Flange. 1955-60 with #23 rear axle | (15A) 194854 Thrust block. 1955-65 all with |
|\$85.80 ea. | tapered axles..... Only available in 520188 kit. |
| (3) 1549708 Flange. 1960-66 with #27 rear | (15A) 1562419 Thrust block. For flanged rear |
| axle.....\$88.00 ea. | axles.....\$18.40 ea. |
| (4 & 5) 199379X1 & 184161 Pinion seal. | (15B) 194834 Gear, side bevel. 1955-60 with |
| 1955-66 all models.....\$19.45/set | #23 rear axle, Order 520188 kit.....\$19.00 ea. |
| (7) 190033 Cone & rollers. 1955-60 with #23 | (15C) 194833 Gear, pinion. 1955-60 with #23 |
| rear axle.....\$37.20 ea. | rear axle..... Order 520188 kit |
| (7) 1549626 Cone & rollers. 1960-66 with #27 | (15D) 194836 Thrust washer. 1955-60 with #23 |
| rear axle.....\$49.05 ea. | rear axle. Takes 2.....\$9.20 ea. |
| (8) 190032 Cup. 1955-60 with #23 rear axle | (15E) 194838 Thrust washer. 1955-60 with #23 |
|\$17.50 ea. | rear axle. Takes 2.....\$9.20 ea. |
| (8) 1549625 Cup. 1960-66 with #27 rear axle.. | (15F) 510722 Pin. 1955-60 with #23 rear axle.. |
|\$11.00 ea. |\$3.40 ea. |
| (9) 190038-41 Shims .003, .005, .010, .030 | (15F) 1685564 Pin. 1960-66 with #27 rear axle. |
| with #23 rear axle.....\$2.90 ea. |\$4.40 ea. |
| (9) 1549630-33 Shims .003, .005, .010, .030. | (16) 196313 Case. 1955-59 all with 4:10, 4:27, |
| 1960-66 with #27 rear axle.....\$2.20 ea. | 4:56 & 4:88 gear ratio.\$148.00 ea. |
| (11) 511652-54 Shims .003, .005, .010. 1955- | (16) 529399 Case. 1955-60 with #23 rear axle |
| 60 with #23 rear axle.....\$2.90 ea. | having 3:54 gear ratio.\$115.50 ea. |
| (11) 1549634-36 Shims .003, .005, .010. | (16) 1549638 Case. 1960-66 with #27 rear axle |
| 1960-66 with #27 rear axle.....\$2.20 ea. | having 3:07, 3:31, 3:54 or 3:73 gear ratio. |
| (12) 190035 Cup. 1955-60 with #23 rear axle... |\$115.50 ea. |
|\$19.30 ea. | (16) 1549639 Case. 1960-66 with #27 rear axle |
| (12) 1549627 Cup. 1960-66 with #27 rear axle | having 4:10, 4:27 or 4:56 gear ratio....\$115.50 ea. |
|\$17.60 ea. | (16A) 527171 Screw. 1955-58 all models and |
| (13) 190036 Cone & rollers. 1955-60 all with | 1960-66 with #27 rear axle. Takes 8.\$5.50 ea. |
| #23 rear axle.....\$51.00 ea. | (16A) 1548650 Screw. 1959-60 with #23 rear |
| (13) 1549628 Cone & rollers. 1960-66 with | axle. Takes 8.....\$4.40 ea. |
| #27 rear axle.....\$38.50 ea. | (17) 1549648-51 Shim. .003, .005, .010, .030. |
| (14) Ring & Pinion..... Call | 1955-66 all models.....\$2.20 ea. |
| (15-15F) 520188 Side bevel gear kit. 1955-60 | (18) 196287 Cone & rollers. 1955-60 with #23 |
| with #23 rear axle. Used.....\$154.00 ea. | rear axle. Takes 2.....\$49.75 ea. |
| (15-15F) 1550291 Side bevel gear kit. 1960-65 | (18) 1690219 Cone & rollers. 1960-66 with #27 |
| with #27 tapered axles.....\$121.00 ea. | rear axle. Takes 2.....\$25.25 ea. |
| (19) 196286 Cup. 1955-60 with #23 rear axle. | (19) 196286 Cup. 1955-60 with #23 rear axle. |
| Takes 2.....\$64.85 ea. | Takes 2.....\$64.85 ea. |
| (19) 1549645 Cup. 1960-66 with #27 rear axle. | (19) 1549645 Cup. 1960-66 with #27 rear axle. |
|\$19.75 ea. |\$19.75 ea. |
| (20) 1560422 Axle shaft. 1955-60 with #23 | (20) 1560422 Axle shaft. 1955-60 with #23 |
| rear axle. Takes 2.....\$93.50 ea. | rear axle. Takes 2.....\$93.50 ea. |
| (20) 1559059 Axle shaft. 1960-62 with #27 | (20) 1559059 Axle shaft. 1960-62 with #27 |
| rear axle. Takes 2.....\$180.00 ea. | rear axle. Takes 2.....\$180.00 ea. |
| (20) 1560426 Axle shaft. 1963-65 with #27 | (20) 1560426 Axle shaft. 1963-65 with #27 |
| rear axle having tapered axles.....\$180.00 ea. | rear axle having tapered axles.....\$180.00 ea. |
| (20) 1562424 Axle shaft. 1965-66 with #27 or | (20) 1562424 Axle shaft. 1965-66 with #27 or |
| 44 rear axle having flanged axles.....\$93.50 ea. | 44 rear axle having flanged axles.....\$93.50 ea. |
| Note for 1562424: For shaft axle assembly | |
| -including axle shaft, bearing, bearing retainer | |
| & seal - order right side 1562422 and Left side | |
| 1562423. | |
| 1562422 Right.....\$250.00 ea. | 1562422 Right.....\$250.00 ea. |
| 1562423 Left.....\$250.00 ea. | 1562423 Left.....\$250.00 ea. |
| (21) 194841 Key. 1955-65 all with tapered | (21) 194841 Key. 1955-65 all with tapered |
| axles. Takes 2.....\$5.50 ea. | axles. Takes 2.....\$5.50 ea. |
| (22) 510516 Nut. 1955-65 all models with | (22) 510516 Nut. 1955-65 all models with |
| tapered axles. Takes 2.....\$18.50 ea. | tapered axles. Takes 2.....\$18.50 ea. |
| (24) 530451 Cone & rollers. 1955-65 all with | (24) 530451 Cone & rollers. 1955-65 all with |
| tapered axles. Takes 2.....\$46.20 ea. | tapered axles. Takes 2.....\$46.20 ea. |
| (24) 1562421 Cone & rollers. 1965-66 all | (24) 1562421 Cone & rollers. 1965-66 all |
| models with "flanged" axles.....\$42.55 ea. | models with "flanged" axles.....\$42.55 ea. |
| (25) 165167 Cup. 1955-66 all models. Takes 2. | (25) 165167 Cup. 1955-66 all models. Takes 2. |
|\$13.00 ea. |\$13.00 ea. |
| (26) 530573 Seal, "inner". 1955-66 all models. | (26) 530573 Seal, "inner". 1955-66 all models. |
| Takes 2.....\$18.00 ea. | Takes 2.....\$18.00 ea. |
| (27) 194844-6 Shims .005, .010, .030. All | (27) 194844-6 Shims .005, .010, .030. All |
| 1955-66 with tapered axles.....\$4.25 ea. | 1955-66 with tapered axles.....\$4.25 ea. |
| (27.5) 519383 Plate, reinforcement. 1955-66 all | (27.5) 519383 Plate, reinforcement. 1955-66 all |
| models. Takes 2. Used.....\$7.00 ea. | models. Takes 2. Used.....\$7.00 ea. |
| (28) 197216 Washer, felt. Outer. 1955-65 all | (28) 197216 Washer, felt. Outer. 1955-65 all |
| models with tapered axles.....\$2.75 ea. | models with tapered axles.....\$2.75 ea. |
| (28A) 1562434 Seal, outer. 1965-66 having | (28A) 1562434 Seal, outer. 1965-66 having |
| flanged axles.....\$9.25 ea. | flanged axles.....\$9.25 ea. |
| (28 B) 1563292 Plate, ring lock. 1965-66 | (28 B) 1563292 Plate, ring lock. 1965-66 |
| having flanged axles.....\$4.40 ea. | having flanged axles.....\$4.40 ea. |
| (29) 533161 Washer & retainer. 1955-65 | (29) 533161 Washer & retainer. 1955-65 |
| all models with tapered axles. Comes with (1) | all models with tapered axles. Comes with (1) |
| 197436 gasket.....\$20.00 ea. | 197436 gasket.....\$20.00 ea. |
| (30) 197436 Gasket. 1955-65 all models with | (30) 197436 Gasket. 1955-65 all models with |
| tapered axles. Takes 4.....\$1.50 ea. | tapered axles. Takes 4.....\$1.50 ea. |
| (30) 1562390 Gasket. 1965-66 all models with | (30) 1562390 Gasket. 1965-66 all models with |
| flanged axles.....\$1.50 ea. | flanged axles.....\$1.50 ea. |
| (31) 1560245 Gasket. 1955-66 all models..... | (31) 1560245 Gasket. 1955-66 all models..... |
|\$10.00 ea. |\$10.00 ea. |
| (32) 194839 Cover. 1955-64 all models..... | (32) 194839 Cover. 1955-64 all models..... |
|\$32.00 ea. |\$32.00 ea. |
| (32) 1560244 Cover. 1965-66 all models..... | (32) 1560244 Cover. 1965-66 all models..... |
|\$22.80 ea. |\$22.80 ea. |
| (33) G103883 Grease plug. 1955-57 all mod- | (33) G103883 Grease plug. 1955-57 all mod- |
| els. Takes 2.....\$1.40 ea. | els. Takes 2.....\$1.40 ea. |
| (34) G143999 Plug. 1955-57 all models..... | (34) G143999 Plug. 1955-57 all models..... |
|\$2.65 ea. |\$2.65 ea. |
| (35) G103869 Plug. 1955-58 all models..... | (35) G103869 Plug. 1955-58 all models..... |
|\$2.65 ea. |\$2.65 ea. |
| (35) G444752 Plug. 1959-66 all models..... | (35) G444752 Plug. 1959-66 all models..... |
|85¢ ea. |85¢ ea. |
| (36) G179890 Screw, differential cap. 1955-60. | (36) G179890 Screw, differential cap. 1955-60. |
|\$2.65 ea. |\$2.65 ea. |

REAR AXLE ASSEMBLY

Pre-War 1947-50 Commander, 1947-54 Champion, 1941-48 M5 Truck & Early 2R-Series 1/2-Ton with Dana #41 Rear Axle

On "Rockne" the parts fit US-built cars only!

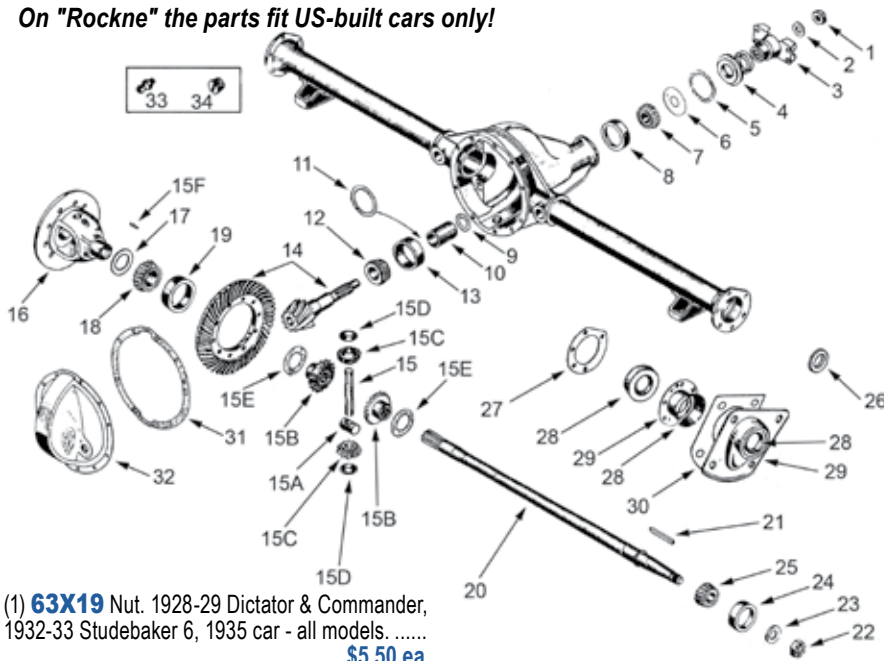

- (1) **63X19** Nut. 1928-29 Dictator & Commander, 1932-33 Studebaker 6, 1935 car - all models. **\$5.50 ea.**
- (2) **196965** Washer. Car: 1932-33 Rockne 65 & 10, 1934-46 all. Truck: M-5 and 2R-series, 1947-54 Champion & 1947-50 Commander. **\$4.40 ea.**
- (3) **521825** Flange. Car: early 1936 Dictator, 1936-37 President, 1938-50 all. Truck: M-5 and 2R 1/2-ton truck. **\$85.80 ea.**
- (4 & 5) **199379X1 & 184161** Oil seal. Car: 1934-54 all. Trucks: 1/2-ton 1941-later. **\$19.45/set**
- (7) **510697** Cone & rollers. Car: 1932-33 Rockne 65 & 10, 1934-35 all & most 1936 Dictator & 1934 Commander 8. **\$38.50 ea.**
- (7) **510694** Cone & rollers, front. Car: 1935-37 President 8 & Canadian-built 1934-36 Dictator. **\$50.00 ea.**
- (7) **190033** Cone & rollers. Front. Some late 1934 and all 1935-46 Dictator, Champion & Commander, 1938-42 President. **\$37.20 ea.**
- (8) **510693** Cup, front pinion. 1932-33 Rockne 65 & 10, all US-built 1934-35 and most 1936 Dictators except 200 late '36 Coupes, also used on some Canadian-built 1934. **\$24.00 ea.**
- (8) **190032** Cup, front bearing. Used on 200 late 1936 Dictator Coupe and all 1937-50 Dictator, Commander and 1939-54 Champion. **\$17.50 ea.**
- (9) **190038-41** Shims .003, .005, .010, .030. Some late 1934 and all 1935-46 Dictator, Champion & Commander, 1938-42 President. **\$2.90 ea.**
- (10) **190037** Spacer. Some 1936 and all 1937-50 Dictator, Commander & 1939-54 Champion, 1938-42 President. **\$5.50 ea.**
- (11) **511652-4** Shims .003, .005, .010. 1934 Commander 8, Some 1936 Dictators, all 1937-50 Dictators, Commander, 1939-54 Champion and 1938-42 President. **\$2.90 ea.**
- (12) **510693** Cup, pinion rear bearing. 1932-33 Rockne 65 & 10, 1934-35 Dictator all except some Canadian-built 1934's. **\$24.00 ea.**
- (12) **511650** Cup, pinion rear bearing, Canadian-built. 1935 Dictator & all 1936 Dictator & Commander 8. **\$16.50 ea.**

- (12) **183904** Cup, pinion bearing rear. 1934 President having axles dated after April 11, 1934. **\$23.00 ea.**
- (12) **510694** Cone & rollers. 1932-33 Rockne 65 & 10, all US & some Canadian-built 1934 and all 1935 Dictators. **\$50.00 ea.**
- (13) **190035** Cup, pinion bearing rear. 1936-50 Dictator, Commander, 1939-54 Champion & 1938-42 President. **\$19.30 ea.**
- (13) **190036** Cone & roller, pinion rear. Some 1934 & all 1935-50 Dictator, Commander & 1939-54 Champion, and 1938-42 President. **\$51.00 ea.**
- (14) Gear set. **Call for availability & price**
- (15-15E) **524709** Differential side gear kit. 1938 Commander 8, 1936-50 Dictator, Commander, President which uses 36 Dictator rear axles. **\$175.00 ea.**
- (15-15F) **520188** Differential side gear kit. 1939-54 Champion. Used. **\$154.00 ea.**
- (15) **510721** Shaft. 1932-33 Rockne 65 & 10, all 1934-50 US-built, Dictator & Commander (and some Canadian), also 1934 Commander 8 & 1938-42 President. **\$31.90 ea.**
- (15) **194835** Shaft. 1939-54 Champion. **\$19.00 ea.**
- (15A) **510725** Thrust block. 1932-33 Rockne 65 & 10, 1934-37 US-built Dictator, some Canadian 1934's. **\$16.50 ea.**
- (15A) **511660** Thrust block. 1934 Dictator 8 & all 1938-50 Commander & President. **\$22.00 ea.**
- (15A) **194854** Thrust block. 1939-54 Champion. **Only available in 520188 kit.**
- (15B) **511677** Gear, side bevel. 1934 Commander 8, 1936-50 Dictator & Commander, 1938-42 President. Not used on some 1936 Dictators. Takes 2. **\$55.00 ea.**
- (15B) **194834** Gear, side bevel. 1939-54 Champion, Order 520188 Differential side gear kit. **\$19.00 ea.**
- (15C) **510716** Pinion gear. 1934-42 Dictator except for some Canadian-built 1934's & 35's. Also used on 1934 Commander 8 & 1938-42 President. Takes 2. **\$33.00 ea.**

- (15C) **194833** Pinion gear. 1939-54 Champion. **Order 520188 Differential side gear kit.**
- (15D) **194836** Thrust washer. 1936-54 Champion. Takes 2. **\$9.20 ea.**
- (15E) **511678** Thrust washer. Same application as 511679. Limit 2 per customer. Takes 2. **\$13.20 ea.**
- (15E) **194838** Thrust washer. Same application as 194836. Takes 2. **\$9.20 ea.**
- (15F) **510722** Pin. 1934-50 Dictator, Commander & 1939-54 Champion, 1934 Commander 8, 1938-42 President, 1932-33 Rockne 65 & 10. **\$3.40 ea.**
- (16) **196313** Case. 1939-54 Champion except 1950-54 with 3:54 gear ratio. **\$148.00 ea.**
- (16) **529399** Case. 1950-54 Champion with 3:54 gear ratio. **\$115.50 ea.**
- (17) **1549648-51** Shims .003, .005, .010, .030. 1932-33 Rockne 65 & 10, 1934-54 all except 1934-37 President. **\$2.20 ea.**
- (18) **181794** Cone & rollers. 1934 & 36 President. Takes 2. **\$38.25 ea.**
- (18) **190048** Cone & rollers. Some 1936 & all 1937 Dictator. All 1938-50 cars except Champion, all M-5 truck and early 2R-series 1/2-ton truck. Takes 2. **\$51.00 ea.**
- (18) **196287** Cone & rollers. 1939-54 Champion. Takes 2. **\$49.75 ea.**
- (18) **190047** Cup. Same application as 190048. Takes 2. **\$23.50 ea.**
- (19) **196286** Cup. Same application as 196287 bearing. Takes 2. **\$64.85 ea.**
- (20) **191707** Axle shaft. 1938-39 Commander, President & Coupe Express. Truck: all M-5 and early 2R-Series 1/2-ton. Takes 2. **\$205.00 ea.**
- (20) **197570** Axle shaft. 1940 Commander & President. Takes 2. **\$132.00 ea.**
- (20) **197861** Axle shaft. 1941-42 Commander & President. Takes 2. **\$110.00 ea.**
- (20) **194840** Axle shaft. 1939-46 Champion. Takes 2. **\$104.50 ea.**
- (20) **521594** 1947-50 Champion. **\$185.00 ea.**
- (20) **521682** Axle shaft. 1947-50 Commander. **\$125.40 ea.**
- (20) **530449** Axle shaft. 1951-52 Champion. **\$93.50 ea.**
- (20) **1560422** Axle shaft. 1953-54 Champion. **\$93.50 ea.**
- (21) **510517** Key. 1932-33 Rockne 65 & 10, 1934-50 Dictator & Commander 6, 1938-42 President and Coupe Express. 1941 & later 1/2-ton truck. Takes 2. **\$2.45 ea.**
- (21) **194841** Key. 1939-54 Champion. Takes 2. **\$5.50 ea.**
- (22) **510516** Nut. 1934-37 Dictator & 1934 Commander 8. Takes 2. **\$18.50 ea.**
- (22) **181782** Nut. 1934, '36 & '37 President, 1938-50 Commander, President & Coupe Express. 1941 & later 1/2-ton truck. Takes 2. **\$8.00 ea.**

CONTINUED ON NEXT PAGE

Rear Axle - Prewar, "Dana 41"

- (22) **537906** Nut. 1939-50 Champion. **\$8.00 ea.**
- (23) **G103348** Washer. 1934 & 1936-42 President, 1938-50 Commander & Coupe Express, 1941 & later 1/2-ton truck. **55¢ ea.**
- (23) **196965** Washer. 1939-50 Champion. Takes 2 **\$4.40 ea.**
- (24) **510728** Cone & rollers. 1932-33 Rockne 65 & 10 and 1934-37 Dictator. Takes 2 **\$36.00 ea.**
- (24) **511664** Cone & rollers. 1934 Commander 8 and 1937 Coupe Express. Takes 2 **\$40.00 ea.**
- (24) **192239** Cone & rollers. 1938-50 Commander, President & Coupe Express, 1941 and later 1/2-ton truck. **\$35.00 ea.**
- (24) **194826** Cone & rollers. 1939-50 Champion. Takes 2 **\$169.50 ea.**
- (24) **530451** Cone & rollers. 1951-54 Champion **\$46.20 ea.**
- (25) **165048** Cup. 1932-33 Rockne 65 & 10, 1934-37 Dictator. Takes 2 **\$27.00 ea.**
- (25) **192238** Cup. Same application as 192239 cone & rollers. Takes 2 **\$18.50 ea.**
- (25) **165167** Cup. 1939-54 Champion. Takes 2 **\$13.00 ea.**
- (26) **516329** Inner axle seal. 1938-50 all cars except Champion, M-5 truck after serial #5, 111, all 2R 1/2-ton truck. Takes 2 **\$18.50 ea.**
- (26) **516330** Inner axle seal. 1939-50 Champion. Takes 2 **\$20.00 ea.**
- (27) **191723-6** Shims .003, .005, .010, .030. 1938-50 all cars except Champion. **\$4.40 ea.**
- (27) **194844-6** Shims .005, .010, .030. 1939-54 Champion. Reconditioned/used **\$4.25 ea.**
- (28) **197591** felt seal. 1938-50 all cars except Champion, 1941 and later 1/2-ton truck. Takes 2 **\$6.60 ea.**
- (28) **197216** Washer, felt. 1939-54 Champion. Takes 2 **\$2.75 ea.**
- (29) **184805** Washer & retainer. 1935-37 Dictator & Coupe Express. Takes 2 **\$33.00 ea.**
- (29) **533161** Washer & retainer. 1939-54 Champion. Takes 2 **\$20.00 ea.**
- (30) **197436** Gasket. 1939-54 Champion. Takes 2 **\$1.50 ea.**
- (31) **511674** Gasket. 1936-50 Dictator, Commander & Coupe Express, 1934 Commander 8, 1938-42 President. Truck: M5, early 2R5 & 6 **\$8.50 ea.**
- (31) **1560245** Gasket. 1939-54 Champion **\$10.00 ea.**
- (33) **G191758** Grease fitting. All 1936-50 cars plus 1934-35 Commander 8 & President. Takes 2 **\$3.30 ea.**
- (34) **G103883** Grease plug. 1946-50 Champion. Takes 2 **\$1.40 ea.**
- G105036** Cup, grease housing. 1934-35 Dictator. Takes 2 **\$5.25 ea.**

G105036 Cup, grease housing. 1934-35 Dictator. Takes 2 **\$5.25 ea.**

TWIN TRACTION AXLE RELATED PARTS

For #23, #27 & #44 Rear Axles

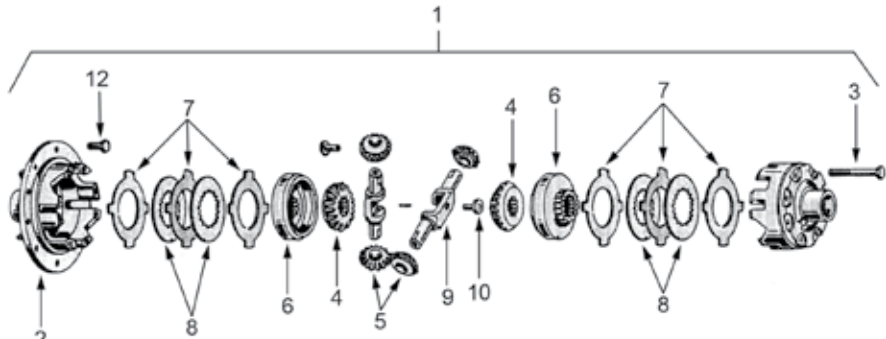

- (1) **1559521** Case assembly. 1963-65 cars with #27 rear axle having 4:10 or 4:56 rear ratio and with tapered axles **\$303.60 ea.**
- (1) **1562443** Case assembly. 1965-66 with #27 flanged rear axle having 3:31 or 3:37 gear ratio **\$303.60 ea.**
- (1) **1562444** Case assembly. 1965-66 with #27 flanged rear axle having 4:10 gear ratio **\$303.60 ea.**
- (2) **1553371** Case. 1959-60 with #23 rear axle having 3:31, 3:54 or 3:78 gear ratio **\$196.95 ea.**
- (2) **1553372** Case. 1959-60 with #23 rear axle having 4:10 or 4:27 gear ratio **\$196.95 ea.**
- (2) **1552108** Case. 1960-66 with #27 rear axle having 3:07, 3:31, 3:54 or 3:73 gear ratio **\$196.95 ea.**
- (2) **1544801** Case. Same as 1544802 except for vehicles having 3:07, 3:31, 3:54 or 3:73 gear ratio **\$225.50 ea.**
- (2) **1544802** Case. Late 1957, all 1958 and possibly 1959-64 with #44 rear axle having 3:92 - 4:55 gear ratio **\$225.50 ea.**
- (3) **1548338** Screw, case to case. 1959-64 with #23 or #27 rear axle. Takes 8 **\$2.20 ea.**
- (3) **1544803** Screw, case to case. All 1957-58 and possibly 1959-64 with #44 rear axle. Takes 8 **\$2.20 ea.**
- (4 & 5) **1548652** Gear kit. Differential side bevel. 1959-64 with #23 or #27 rear axle **\$148.50 ea.**
- (4 & 5) **1562439** Gear kit. Differential side bevel. 1965-66 with #27 flanged rear axle **\$115.50 ea.**
- (6) **1548340** Ring, differential side gear. 1959-64 with #23 or #27 rear axle. Takes 2 **\$82.50 ea.**
- (6) **1562441** Ring, differential side gear. 1965-66 with #27 flanged rear axle **\$82.50 ea.**
- (6) **1544805** Ring. Late 1957 and all 58-64 with #44 rear axle. Takes 2 **\$99.00 ea.**
- (7) **1545887** Plate .096-.101. Same application as 1545886 **\$13.75 ea.**
- (7) **1548344** Plate. 1959 cars with #23 rear axle. Takes 4 **\$13.75 ea.**
- (7) **1551336** Plate .059-.061. 1959-64 with #23 or #27 rear axle. Takes 2 **\$13.75 ea.**
- (7) **1545886** Plate .092-.097. Late 1957, 1958-59 all models and possibly 1960-64 with #44 rear axle. 1957-59 takes 6, 1960 & later takes 4. **No Stock**
- (8) **1548341** Disc. 1959-64 all models with #23 or #27 rear axle. Takes 2 **\$10.45 ea.**
- (8) **1558565** Disc. 1963-64 with #23 or #27 rear axle. Takes 2 **\$10.45 ea.**
- (7 & 8) **1559522** Plate & disc kit. 1959-66 all models with #23 or #27 rear axle **\$69.30 ea.**
- (7 & 8) **1563206** Plate & disc kit. 1957-66 all models with #44 rear axle **\$145.00 ea.**
- (9) **1549644** Shaft, or differential pinion. 1959-64 with #23 or #27 rear axle. Takes 2 **\$42.35 ea.**
- (10) **1548342** Thrust block. 1959-64 with #23 or #27 rear axle. Takes 2 **\$10.45 ea.**
- (10) **1544810** Thrust block. Late 1957 and all 1958-64 with #44 rear axle. Takes 2 **\$22.00 ea.**

REAR SPRING U-BOLTS

Many applications. Please use your Studebaker Chassis manual to determine correct size for your vehicle. Also see pg. 262.

- 519757** 7". 1947-49 Commander. **\$13.25 ea.**
- 535732** 5.5". 1954 Champion wagon, 1955 Champion sedan, 1955 wagon with standard differential **\$17.75 ea.**
- 535733** 5.75". 1954-58 car, most models **\$10.00 ea.**
- 666233** 8". Truck: M-5 10, 11, 12, 2R-3E **\$13.25 ea.**
- 666370** 14.25". M16-17 with two speed rear axle **\$14.00 ea.**
- 677545X1** 12.875" **\$12.00 ea.**
- 677545X3** 13.5". 2R - 2E **\$22.25 ea.**
- 677545X4** 15.25" **\$22.25 ea.**
- 677545X7** 11.75" **\$12.00 ea.**
- 677545X12** 14.75" **\$22.25 ea.**
- 677721X1** 9.25" **\$10.00 ea.**
- 678884X1** 8.25" **\$10.00 ea.**
- 1558540** 5.5". 1963-66 Lark except station wagon with #27 rear axle and standard springs. **\$8.00 ea.**
- 1558541** 5.875". 1963-66 6-cylinder station wagon with heavy duty springs **\$8.00 ea.**



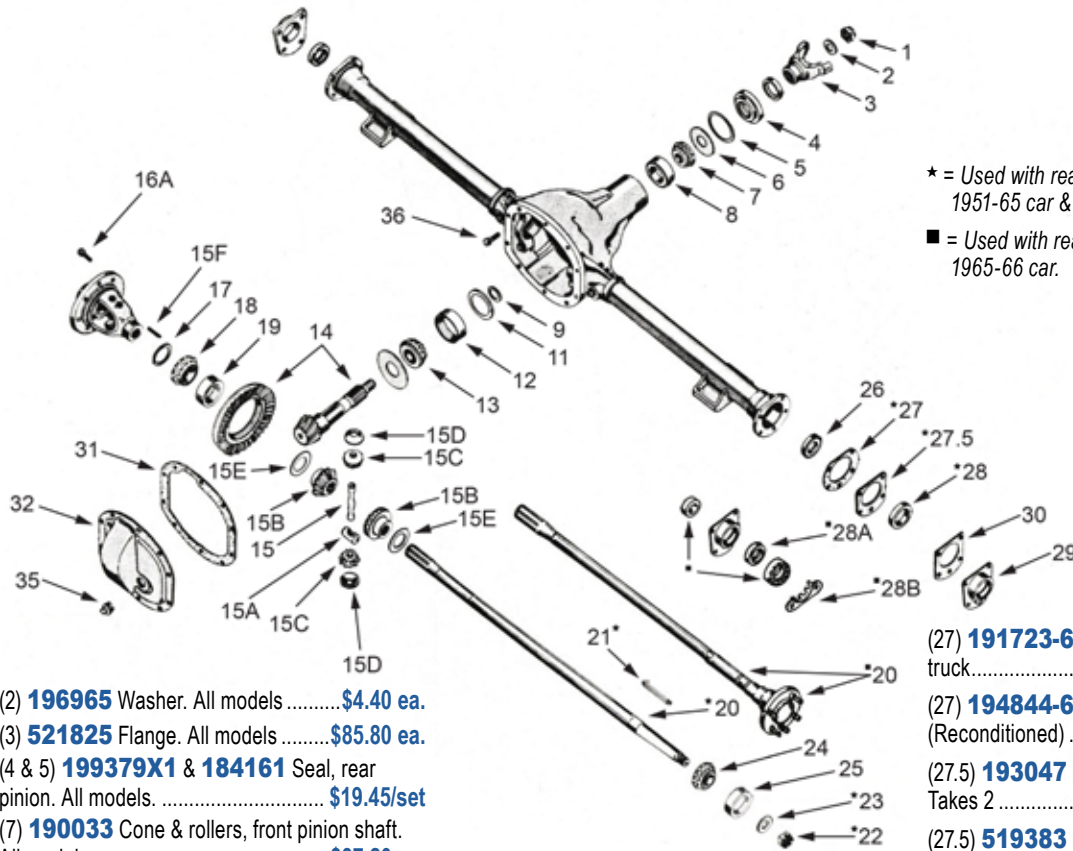

* = Used with rear axle with tapered shafts.
1951-65 car & truck.

■ = Used with rear axle with flanged axle shafts.
1965-66 car.

- (2) **196965** Washer. All models **\$4.40 ea.**
- (3) **521825** Flange. All models **\$85.80 ea.**
- (4 & 5) **199379X1** & **184161** Seal, rear pinion. All models. **\$19.45/set**
- (7) **190033** Cone & rollers, front pinion shaft. All models **\$37.20 ea.**
- (8) **190032** Cup, front pinion shaft. All models. **\$17.50 ea.**
- (9) **190038-41** Shims .003, .005, .010, .030. All models **\$2.90 ea.**
- (11) **511652-4** Shims .003, .005, .010. All models **\$2.90 ea.**
- (12) **190035** Cup, rear pinion shaft. All models. **\$19.30 ea.**
- (13) **190036** Cone & rollers, rear pinion shaft. All models **\$51.00 ea.**
- (14) Ring & pinion **Call**
- (15-15F) **530705** Kit, differential side gear. All models. May contain some used parts. **\$275.00 ea.**
- (15) **1692002** Shaft. All models **\$31.90 ea.**
- (15B) Gear, differential side bevel **Order kit 530705**
- (15C) Gear, differential pinion. **Order kit 53075**
- (15E) **511678** Thrust washer. All models. Takes 2 **\$13.20 ea.**
- (15F) **510722** Pin. All models **\$3.40 ea.**
- (16) **530702** Case. 3:92-4:56 gear ratio **\$133.10 ea.**
- (16A) **527171** Screw. All models. Takes 8 **\$5.50 ea.**
- (17) **1549648-51** Shims .003, .005, .010 & .030. All models **\$2.20 ea.**
- (18) **190048** Cone & rollers. All models. Takes 2 **\$51.00 ea.**
- (19) **190047** Cup. All models. Takes 2 **\$23.50 ea.**
- (20) **191707** Axle shaft. 2R through E-series (1955) truck. Takes 2 **\$205.00 ea.**

- (20) **530499** Axle shaft. 1951-52 Commander. Takes 2 **\$94.00 ea.**
- (20) **1554042** Axle shaft. 1953-65 cars with tapered axles **\$150.00 ea.**
- (20) **1562424** Axle shaft. 1965-66 with flanged axles. (Axle assemblies 1562422/423 available on page 284) Takes 2 **\$93.50 ea.**
- (21) **510517** Key. All trucks. Takes 2. . **\$2.45 ea.**
- (21) **194841** Key. All cars with tapered axles. Takes 2 **\$5.50 ea.**
- (22) **181782** Nut. All trucks. Takes 2. . **\$8.00 ea.**
- (22) **510516** Nut. All cars with tapered axles. Takes 2 **\$18.50 ea.**
- (23) **G103348** Washer. All trucks. Takes 2. **55¢ ea.**
- (24) **192239** Axle cone & rollers. All trucks. Takes 2 **\$35.00 ea.**
- (24) **530451** Axle cone & rollers. All cars with tapered axles. Takes 2 **\$46.20 ea.**
- (24) **1562421** Axle cone & rollers. All cars with flanged axles. Takes 2 **\$42.55 ea.**
- (25) **192238** Cup, axle. All trucks. Takes 2 **\$18.50 ea.**
- (25) **165167** Cup. All cars. Takes 2. . **\$13.00 ea.**
- (26) **516329** Rear axle seal, inner, 2R through E-series (1955) Trucks. Takes 2 **\$18.50 ea.**
- (26) **1685410** Rear axle seal, inner 2E (1956) through 8E (1964) Trucks. Takes 2 **\$25.50 ea.**
- (26) **530573** Rear axle seal, inner. All cars **\$18.00 ea.**

- (27) **191723-6** Shims .003, .005, .010, .030. All truck **\$4.40 ea.**
- (27) **194844-6** Shims .005, .010, .030. All cars. (Reconditioned) **\$4.25 ea.**
- (27.5) **193047** Reinforcement plate. All truck. Takes 2 **\$6.95 ea.**
- (27.5) **519383** Reinforcement plate. All cars. Takes 2. Used **\$7.00 ea.**
- (28) **197591** Seal, felt. Subs for 191023 rear axle outer. 2R-8E truck. Takes 2 **\$6.60 ea.**
- (28A) **1562434** Seal, outer. 1965-66 cars with flanged axles. Takes 2 **\$9.25 ea.**
- (28B) **1563292** Plate, ring lock. 1965-66 having flanged axles. Takes 2 **\$4.40 ea.**
- (29) **533161** Seal & retainer. All 1951-65 cars with tapered axles. Also includes (1) 197436 gasket. Takes 2 **\$20.00 ea.**
- (30) **197436** Gasket. All cars with tapered axles. Takes 4. **\$1.50 ea.**
- (30) **1562390** Gasket. 1965-66 with flanged axles. Takes 2 **\$1.50 ea.**
- (31) **1561783** Gasket. All models **\$10.00 ea.**
- (32) **530600** Cover. All models **\$35.00 ea.**
- (34) **G103887** Grease plug. Truck: 2R through E-series. Takes 2 **No longer available**
- (34) **G103883** Grease plug. 2E-8E. Takes 2 **\$1.40 ea.**
- (35) **G103869** Filler plug. All models. **\$2.65 ea.**
- (36) **G179890** Screw, differential bearing cap. All models. Takes 4 **\$2.65 ea.**
- (37) **G143999** Drain plug. 1951-58 car. Truck: 2R-6E **\$2.65 ea.**
- (37) **684973** Drain plug. Truck: 7E & 8E **\$8.45 ea.**
- (37) **G444672** Drain plug. 1959 Car... **\$8.45 ea.**
- 802507** Convert your tapered axles to flanged axles. Enough for both sides **\$900.00/kit**

Chuck Donley's 1963 Race Avanti from Pilot Hill, California



AVANTI BODY PANELS

- (1) **800715** Front nose panel with round headlights.1963. (1-piece)..... **\$415.00 ea.**
- (1) **800716** Front nose panel with square headlights.1964-85. (1-piece) **\$415.00 ea.**
- (2) **800717** Lower lip. 1963-85 **\$109.95 ea.**
- (3) **800718** Upper air deflector. 1963-85 **\$109.95 ea.**
- (4) **800719** Left headlight bucket. 1963 **\$146.50 ea.**
- (5) **800720** Right headlight bucket. 1963 **\$146.50 ea.**
- (4) **800721** Left headlight bucket. 1964-85 **\$125.00 ea.**
- (5) **800722** Right headlight bucket. 1964-85 **\$125.00 ea.**
- (7) **800723** Left hinge pocket. 1963-85 **\$76.95 ea.**
- (6) **800724** Right hinge pocket. 1963-85 **\$76.95 ea.**
- (8) **800725** Left front fender. 1963-64 **\$370.00 ea.**
- (8) **800726** Right front fender. 1963-64 **\$370.00 ea.**
- (8) **802008** Right front fender, 1965-85 Avanti II models that don't require a filler panel around the wheel well **\$420.00 ea.**
- (8) **802009** Left front fender, 1965-85 Avanti II models that don't require a filler panel around the wheel well **\$420.00 ea.**
- (9) **800727** Filler panel to adapt 800725 left front fender wheel opening **\$81.00 ea.**

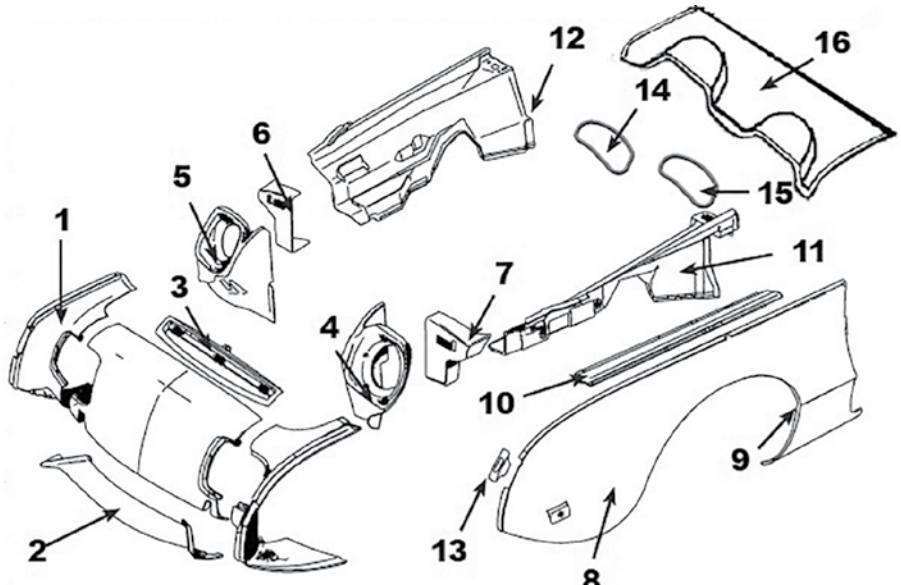

- (9) **800728** Filler panel used to adapt 800726 right front fender wheel opening **\$81.00 ea.**
- (10) **800729** Left fender to inner fender extension.1963-85 **\$85.00 ea.**
- (10) **800730** Right fender to inner fender extension.1963-85 **\$65.00 ea.**
- (11) **800731** Left inner fender. 1963 **\$210.00 ea.**
- (12) **800732** Right inner fender. 1963-85 **\$210.00 ea.**
- (11) **800733** Left inner fender. 1964-85 **\$189.95 ea.**
- (13) **800734** Parking light housing. 1963 **\$69.95 ea.**
- (14) **1350320** Right firewall reinforcer **\$35.00 ea.**
- (15) **1350321** Left firewall reinforcer **\$35.00 ea.**
- (16) **1350181** Behind rear seat shelf **\$85.00 ea.**

FRONT FENDERS FOR 1959-63 LARK & 1960-64 CHAMP TRUCK

- 1337304** Right, 1959-60 Lark. Truck: 1960-64 Champ **\$435.00 ea.**
- 1337305** Left, 1959-60 Lark. Truck: 1960-64 Champ **\$435.00 ea.**
- 1342600** Right, 1961-63 Lark **\$375.00 ea.**
- 1342601** Left, 1961-63 Lark **\$375.00 ea.**

EXCELLENT QUALITY!!!

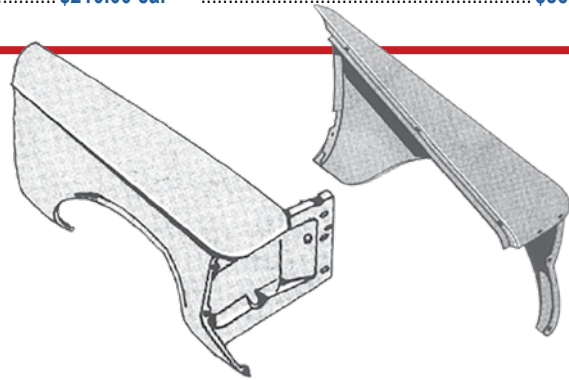

1941-48 M-SERIES TRUCK PANELS

- 648702** Right fender, front or rear. M-5. (1601-2) **\$245.00 ea.**
- 648702X2** Right fender, front or rear. M-5. 2 inches wider than 648702. (1601-2) ... **\$255.00 ea.**
- 648703** Left fender, front or rear. M-5. (1601-2) **\$245.00 ea.**
- 648703X3** Left fender, front or rear. M-5. 2 inches wider than 648703. (1601-2) ... **\$255.00 ea.**
- 648942** Right running board. M-5. (1618-2) **\$160.00 ea.**
- 648943** Left running board. M-5. (1618-2) **\$160.00 ea.**

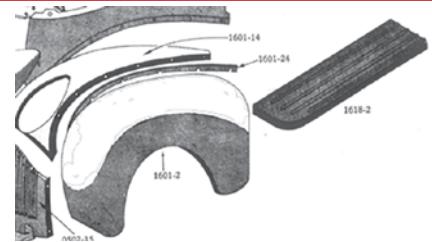

DASH BOARDS Complete fiberglass panels



- 1326650** 1959 Hawk **\$225.00 ea.**
- 1337216** 1956-61 Hawk **\$225.00 ea.**
- 1351408** 1963 Hawk **\$225.00 ea.**

REAR FENDERS, 1949-64 NARROW BED PICKUP

- 651844** Right. (1604-1) **\$295.00 ea.**
- 651845** Left. (1604-1) **\$295.00 ea.**

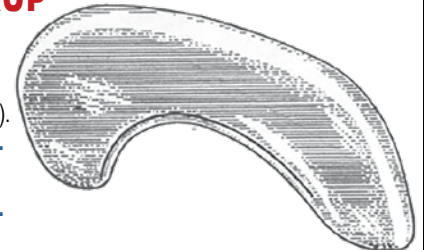

Ready for framing, these beautiful 11" X 14" black and white copies of original factory photographs are sold individually or in one money saving set!

800953

Complete set of 35 Pictures \$99.95/set 35



800606 1926 Big Six with Sheriff.\$3.50 ea.



800607 1928 President.....\$3.50 ea.



800608 1932 with Laurel & Hardy.\$3.50 ea.



800609 1932 St. Regis with Our Gang.....\$3.50 ea.



800610 1934 ready for shipping...\$3.50 ea.



800611 R-series trucks.....\$3.50 ea.



800612 1953 Hardtop introduction.....\$3.50 ea.



800613 1956 Golden Hawk.....\$3.50 ea.



800614 1957 Golden Hawk.....\$3.50 ea.

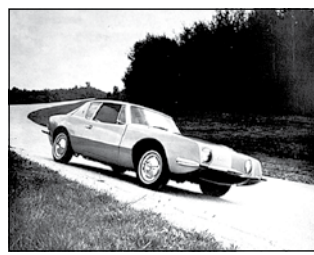

800615 1963 Avanti.....\$3.50 ea.



800776 M-series truck.....\$3.50 ea.



800868 1931 President Roadster.....\$3.50 ea.



800869 1937 service station.....\$3.50 ea.



800870 1938 Coca-Cola truck.....\$3.50 ea.



800871 1939 Champion on car hauler.....\$3.50 ea.



800872 1950 on final assembly line.....**\$3.50 ea.**



800877 1963 Hawk at Proving Ground.....**\$3.50 ea.**



801408 1956 Sedan in cold weather testing room**\$3.50 ea.**



801696 1953 on final assembly line.....**\$3.50 ea.**



800873 1950 Hodak dealership ...
.....**\$3.50 ea.**



800878 Champ pick-up at Proving Ground.....**\$3.50 ea.**



801686 Knute Rockne & Joe Savoldi with 1930 President.....
.....**\$3.50 ea.**



801806 2R Pickup with Weasel ...
.....**\$3.50 ea.**



800874 1955 Speedster.....
.....**\$3.50 ea.**



801405 1916 6-cylinder, touring with J.M. Studebaker.....**\$3.50 ea.**



801687 1952 on final assembly line.....**\$3.50 ea.**



801807 Football coach Knute Rockne standing beside a new Rockne**\$3.50 ea.**



800875 1959 Newman & Altman dealership.....**\$3.50 ea.**



801406 1940 in front of South Bend dealership.....**\$3.50 ea.**



801688 1955 on final assembly line.....**\$3.50 ea.**



801808 1958 cars on final assembly.....**\$3.50 ea.**



800876 1959 Hawk at Proving Ground.....**\$3.50 ea.**



801407 1941 on final assembly line.....**\$3.50 ea.**



801689 1962 on final assembly line.....**\$3.50 ea.**



801809 1951 cars & trucks
.....**\$3.50 ea.**

STUDEBAKER'S FINEST

by John Bridges

800052

A history & restoration guide for the 1953-54 Studebaker Sports Coupe. Follows the development and design of the 1953 Studebaker with many factory photos from styling proposals to the finished design.

This book contains much historical information from designer Bob Bourke to all aspects of the design of the 1953-1954 models. A section on manufacturing of the cars contains lots of factory photos of the production line and history of the production problems that plagued the new model. Production figures are included for Champion & Commander models as well as coupes & sedans for both 1953 & 1954 car.

Another section covers how the new 1953-54 models were promoted around the world. Many factory publicity photos are included. There is also a listing of the 18 awards the new design received. This book contains much detailed information with photos concerning emblems, trim, upholstery, accessories, colors etc. that is very useful when restoring one of these vehicles. Changes in the 1954 model are detailed which is also documented with lots of pictures. Specifications and I.D. number locations are listed as well. A section covering 1955 models as well as 1956-64 Hawks is also included. High performance models are included with a special listing of Bonneville records set by 1953 or 1954 coupes. A final section contains restoration basics for these cars with a lot of critical information for anyone restoring or considering restoring one of these cars. It's unfortunate that there isn't a book like this for every year & model of Studebaker. However, this book contains information of interest for all Studebaker enthusiasts, and restorers of other Studebaker models..... **\$39.95 ea.**

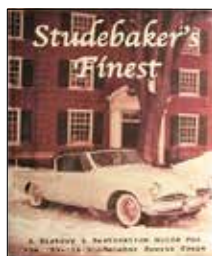

BOB BOURKE DESIGNS FOR STUDEBAKER FINEST

by John Bridges

800470

Bob Bourke participated in the design of the new 1947 postwar model, 1950-52 car, 1953-55 car, 1949-55 truck & 1956 Hawk. Many Bourke idea sketches are included, plus original factory pictures.

This 197 page hardback tells how some of our favorite designs were created..... **\$39.95 ea.**

STUDEBAKER'S HIDDEN TREASURE

by Mark James

802393

A new book that not only concentrates on the Golden Hawks of 1956-1958, it also includes much of the history surrounding these cars' manufacture. A must read for all automotive enthusiasts. Hardbound, 88 pages, full-color. **\$29.95 ea.**



STUDEBAKER 1933-1942 PHOTO ARCHIVE

by Howard L. Applegate

800936

This photo reference book covers both Studebaker cars and trucks from 1933-42, using over 130 original black and white factory photos.

144 pages..... **\$29.95 ea.**

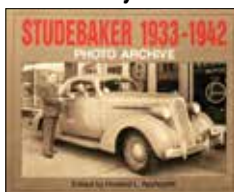

STUDEBAKER AVANTI OPERATION AIRLIFT

by John Hull

802465

A 91 page book of the Avanti and Sherwood H. Egbert's plan to showcase the car for the nearly 2,000 Studebaker dealers at the time of its unveiling. Authored by John Hull with many archival photos of the event. **\$29.95 ea.**



STUDEBAKER HAWK PHOTO ARCHIVE 1956-64

by Ed Reynolds

801544

A collection of over 120 photos presenting a pictorial history of the Hawk. This book includes mostly original

Studebaker factory photographs of all Hawk models produced year by year. Also includes photos of styling studies and original prototypes as well as interiors, engines, engine compartments and trunks. Each photo is captioned with historical as well as technical information on the Hawk. This book is useful for the restorer and will be a valuable addition to your Studebaker library. **\$29.95 ea.**



STUDEBAKER TOY TREASURES

by Jim Geary

801676

With a collection of over 1200 color photos, Jim Geary presents a pictorial history of Studebaker toys. The book

contains color pictures of Studebaker toy cars, trucks, wagons, military vehicles, and juvenile vehicles.

It is a great reference for the Studebaker toy enthusiast and lists over 1900 known toys. Makes a great coffee table book too **\$39.95 ea.**



STUDEBAKER AND BYERS A. BURLINGAME: END OF AN AUTOMOTIVE LEGACY

by Robert R. Ebert

802364 This book examines the last three years of the production of automobiles by the Studebaker Corporation under the leadership of Byers Burlingame using corporate documents and photographs. From the closing of the South Bend plant in 1963 to

the end of auto production at the Hamilton, Ontario plant in March 1966, the company's decisions are analyzed from economic, management, and marketing perspectives. 62 pages **\$44.95 ea.**

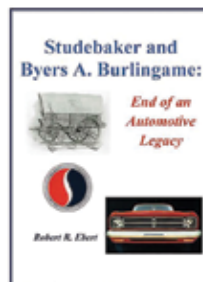

AVANTI: THE COMPLETE STORY

by John Hull

801846

Avanti is Italian for "forward" or "advance" & the car lived up to its name. This book tells the amazing story from the Avanti inception in South Bend, Indiana, to its current status in Cancun, Mexico. Many original source documents, factory photographs, corporate records, advertisements, and first hand accounts trace the evolution of this American classic. The Avanti design was conceived by one of the greatest industrial designers - Raymond Loewy & his associates for Studebaker. The Avanti was Studebaker's shining star for a brief period of time (1963-1964 model years) before the company exited the automobile manufacturing business in the United States in December of 1963. The Avanti exhibited phoenix like traits a number of times since & has gone through more than a handful of owners along with updates in design, maintaining a loyal customer base large enough to support production as a luxury specialty car, on & off for more than 45 years. Get the full scoop from an Avanti insider on the companies and people who helped keep Avanti alive **\$39.95 ea.**

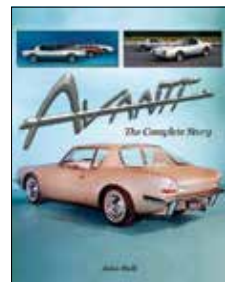

STUDEBAKER LARK PHOTO ARCHIVE 1959-66

by Ed Reynolds

801628

At last there is a book covering the eight years of Lark production. Over 120 photos captioned with historical and anecdotal information for 1959-66. Includes photos of styling proposals, prototypes, engine compartments, trunks, and interiors as well as most body styles. An excellent reference book with lots of information and a useful addition to your Studebaker library..... **\$29.95 ea.**

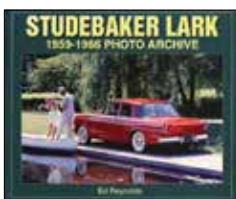

STUDEBAKER TRUCKS PHOTO ARCHIVE 1927-40

by Howard L. Applegate

800950

A very complete photo history of Studebaker trucks. Includes light and heavy duty trucks & semi-tractors. 128 photos. Approximately 124 black & white photographs..... **\$29.95 ea.**

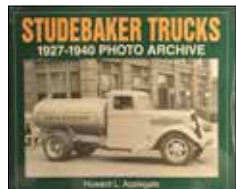

STUDEBAKER HAWKS & LARKS

Compiled by R.M. Clark

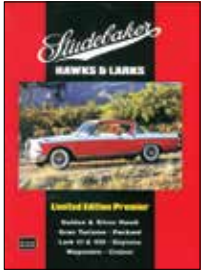

802133 This book contains a compilation of 47 articles on Larks and Hawks covering models from 1958 to 1966. Included are road & comparison tests, model introductions, driver reports, a consumer analysis & a comprehensive history of the cars. Models reported on include the Lark, Daytona, Wagonaire, Cruiser, & also the Silver, Golden, GT & Packard Hawks. 160 pages.. **\$32.95 ea.**

STUDEBAKER'S LAST DANCE: THE AVANTI

by Andrew Beckman

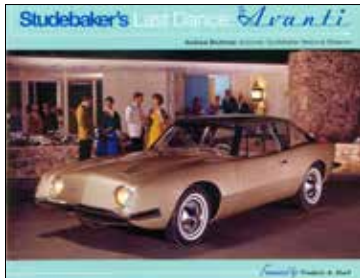

802205 The Avanti's story is one of the automotive industry's most remarkable tales. Its debut in April of 1962 is a testament to the hard work and dedication of everyone involved with Studebaker's sports car. In the end, the Avanti did not save Studebaker. By 1962 it can be argued nothing could have. Still, the company's quest for salvation brought them back to the playbook that made Studebaker a styling leader. Fresh, original design backed by the Raymond Loewy name. "Studebaker's Last Dance: looks at how America's oldest automobile manufacturer came to build "America's Most Advanced Automobile.". 62 pages.**\$24.95 ea.**

THE OFFICIAL GUIDE TO MODERN GASOLINE & OIL FOR ANTIQUE VEHICLES

802333 This 60-page book explains how the changes to modern gasoline and engine oil have affected antique vehicles, and what you need to do to protect your antique vehicle from these changes **\$12.00 ea.**

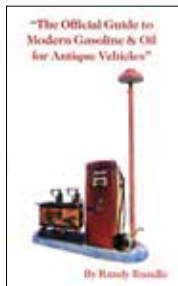

THE OFFICIAL GUIDE TO SHOP KINKS AND TECH TIPS 1940-1960

802335 Learn over 140 tech tips and mechanical shortcuts from those who made their living working on these cars and trucks every day. A must have for every shop and automotive library..... **\$10.00 ea.**



CHAMPION OF THE LARK

by Robert R. Ebert

802281 A career engineer at Studebaker, Harold E. Churchill became president of the recently merged Studebaker-Packard Corporation in 1956, at a time when finances were shaky and an aging product line was losing ground to the Big Three. Quickly launching a program of "realism and common sense," he focused the company's energies on his vision for a compact economy car the Lark. This book examines Churchill's leadership using board of directors minutes, internal documents, oral histories and media reports to construct a detailed account of these crucial years in Studebaker's history **\$39.95 ea.**

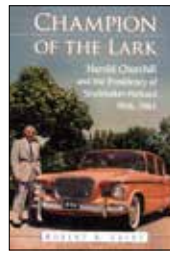

"HELP, MY CAR WON'T START WHEN IT'S HOT"

by Randy Rundle

802353 In this book, you will learn how to identify and fix your hot start problems. You will learn what works, what doesn't and why. 60 pages with over 50 color illustrations. 5.5x8.5 inches **\$14.00 ea.**



MURDER IN SOUTH BEND

A novel by John Bridges

802391 John Bridges is a retired engineer and industrial designer with over 100 U.S. and foreign patents to his credit. He has restored a number of classic automobiles including several Studebakers. He has written numerous articles for automotive magazines. **\$19.95 ea.**

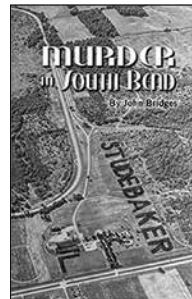

BORG WARNER OVERDRIVE MANUAL

802482 1928-1966 automotive transmissions manual **\$20.00 ea.**



OVERDRIVE GUIDE BOOK

802337 This 8.5"x11" - 40 page, illustrated guide explains everything you need to know about operating and trouble shooting the Borg-Warner "R" Series overdrive transmission. If your car is equipped with a Borg-Warner overdrive transmission, this is a must have book. Includes factory service information, interchanged guide and illustrated wiring diagrams **\$15.00 ea.**

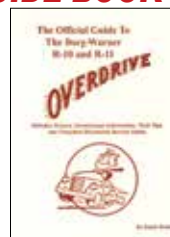

STUDEBAKER 1946-1966

by R.M. Clark

802206 A portfolio of over seventy contemporary articles tracing the ups & downs of the last twenty years of Studebaker production. Included are new model releases, road & comparison tests, consumer analyses plus full specifications & performance data. Models reported on include the Champion, & Cruiser, Conestoga, Commander, Starliner, President, Speedster, Hawk, Lark, Avanti, Cruiser & Daytona. 216 pages..... **\$37.95 ea.**

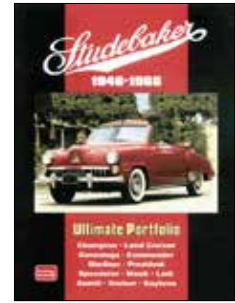

SOUTH BEND & STUDEBAKER WATCHES

by Ernest M. Loga

802192 A complete history of the former watch maker with many pictures. Discusses the various watch types, sizes, interior artwork, adjustments, cases, dials, etc. Also includes some production records. Copies of original ads for the various watches are also included. This is an essential book for anyone owning or considering owning a South Bend Studebaker watch. 52 pages **\$15.00 ea.**



THE OFFICIAL 12-VOLT CONVERSION GUIDE

802334 This is a complete, step-by-step guide, for upgrading to a 12-volt electrical system. Alternators, mounting brackets, pulleys, overdrives, ignition coils, generators, 6/12 bulb crossover numbers, its all included. Save time and money by learning why you do not need to change the headlight switch, starter solenoid, heater and ignition switches, or the ignition points and condenser when you upgrade to 12-volts. This complete 25-page guide explains everything you need to know in simple "common sense" plain English. A complete parts source list is also included **\$10.00 ea.**



THE OFFICIAL GUIDE TO COOLING SYSTEMS

802336 Learn the secrets of how a cooling system works so you can solve your own cooling system problems. Like most anything else, if you know and understand the rules of the game it makes the job much easier. 8.5"x11" - 36 pages..... **\$15.00 ea.**

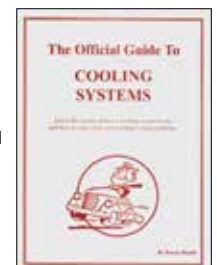

Studebaker started using window stickers in 1959. These are copies of those used by Studebaker. We've also made window stickers for cars & trucks prior to 1959. Just fill in the information for your vehicle.

LARK, HAWK & TRUCK



800963 1959 Lark, Hawk & truck..
..... \$3.50 ea.



800964 1960 Lark, Hawk & truck..
..... \$3.50 ea.



800965 1951 Lark, Hawk & truck..
..... \$3.50 ea.



800966 1962 Lark, Hawk & truck..
..... \$3.50 ea.

LARK, HAWK, TRUCK & AVANTI



800967 1963 Lark, Hawk, Avanti & truck..... \$3.50 ea.

800968 1964 Lark, Hawk, Avanti & truck..... \$3.50 ea.



1965-66 LARK



800969 1965-66 Lark..
..... \$3.50 ea.

AVANTI



801084 1988 Avanti coupe.....
..... \$5.00 ea.



801085 1988 Avanti LSC.....
..... \$5.00 ea.

CHAMPION, COMMANDER & PRESIDENT



801490 1939 Champion, Commander & President... \$5.00 ea.



801491 1940 Champion, Commander & President... \$5.00 ea.



801492 1941 Champion, Commander & President... \$5.00 ea.



801514 1955 Champion, Commander & President... \$5.00 ea.



801515 1956 Champion, Commander & President... \$5.00 ea.

SPEEDSTER



801494 1955 Speedster.....
..... \$5.00 ea.

PRESIDENT



801486 1931 President.....
..... \$5.00 ea.

COUPE EXPRESS



801487 1937 Coupe Express.....
..... \$5.00 ea.

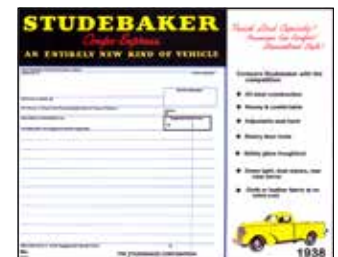

801488 1938 Coupe Express.....
..... \$5.00 ea.



801489 1939 Coupe Express.....
..... \$5.00 ea.

PICKUP



801519 1942-48 M-series truck...
\$5.00 ea.



801520 1949-53 R-series truck...
\$5.00 ea.



801523 1960-64 Champ & Transtar trucks...
\$5.00 ea.

CHAMPION, COMMANDER & LAND CRUISER



801493 1950 Champion, Commander & Land Cruiser...
\$5.00 ea.



801507 1947 Champion, Commander & Land Cruiser...
\$5.00 ea.



801508 1948 Champion, Commander & Land Cruiser...
\$5.00 ea.



801509 1949 Champion, Commander & Land Cruiser...
\$5.00 ea.



801510 1951 Champion, Commander & Land Cruiser...
\$5.00 ea.



801511 1952 Champion, Commander & Land Cruiser...
\$5.00 ea.



801512 1953 Champion, Commander & Land Cruiser...
\$5.00 ea.



801513 1954 Champion, Commander, Land Cruiser & station wagon...
\$5.00 ea.



801516 1957 Studebaker or Packard...
\$5.00 ea.



801517 1958 Studebaker or Packard...
\$5.00 ea.

PLACE ORDERS

ONLINE AT

www.studebaker-intl.com

OR CALL

(317) 462-3124

PACKARD HAWK



801518 1958 Packard Hawk...
\$5.00 ea.

GOLDEN HAWK



801495 1956 Golden Hawk...
\$5.00 ea.



801496 1957 Golden Hawk...
\$5.00 ea.

2"X2" TEMPORARY TATTOOS



801386 Studebaker logo. Red, white & blue. \$2.50/set 5



801678 Avanti logo. Red, white and blue. \$2.50/set 5



801679 "Studebaker Trucks" logo. Red. \$2.50/set 5



801680 "Studebaker Racing" logo. Black & red. \$2.50/set 5

Designed by Gary Hallgren



801067
"Santa drives his Stude"
Inside print:
"Celebrating the season with an appreciation of yesterday and anticipation of tomorrow! Happy Holidays!" 5" x 7"
\$19.95/set 20

801416
1950 convertible.
Inside print: "Happy Holidays" 5.5" x 4"
\$12.95/set 20



801417
1954 hardtops.
Inside print:
"Happy Holidays".
5.5" x 4"
\$12.95/set 20

801418
1959 Hawk.
Inside print:
"Happy Holidays"
5.5" x 4"
\$12.95/set 20

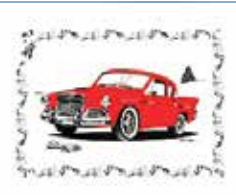

801419
Champ truck.
Inside print:
"Happy Holidays"
5.5" x 4"
\$12.95/set 20

801420
1964 Wagonaire.
Inside print:
"Happy Holidays"
5.5" x 4"
\$12.95/set 20



801421
Avanti.
Inside print:
"Happy Holidays"
5.5" x 4"
\$12.95/set 20

801423 Santa guides his bulletnose Studebaker delivering gifts. This 5.5" x 4" card is based on original Studebaker artwork.
Inside print: "Happy Holidays" \$12.95/set 20



800893 1950 Commander convertible.
Inside print: "Best Wishes For A Classic Holiday Season!" 5" x 7"
\$19.95/set 20

Designed by Kelly J. Agee

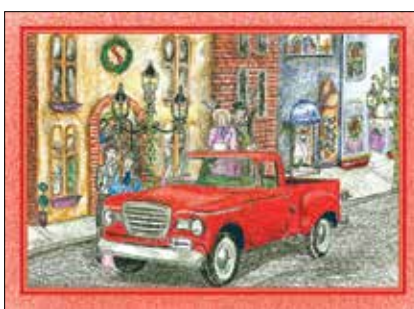

802024 "Classic Caroling" Inside print: Celebrating the season with an appreciation of yesterday and anticipation of tomorrow! Happy Holidays!" 5" x 7"\$22.00 set/20



802026
1960 Hawk
"Perfect Holiday"
Inside print:
"A Perfect Holiday Season!"
5" x 7"
\$22.00 set/20



802045 "1953 Starlight" Inside print: "Merry Christmas!" 5" x 7"\$22.00 set/20

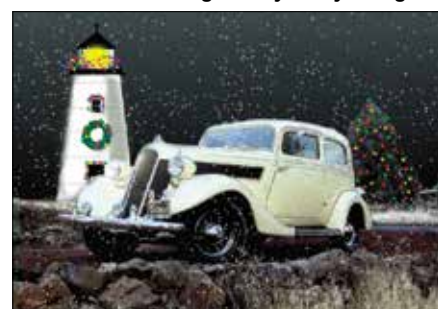

802047 "1935 Dictator" Inside print: "A Classic Merry Christmas!" 5" x 7"\$22 set/20

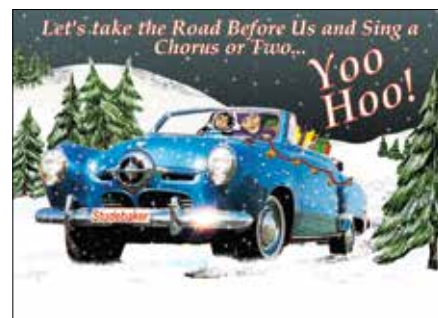

802048 "Studebaker Ride" Inside print: "It's lovely weather for a Studebaker" 5" x 7"\$22.00 set/20



802167 "1952 Land Cruiser" Inside print: "A Classic Merry Christmas!" 5" x 7"\$22.00 set/20

Cards make great gifts!

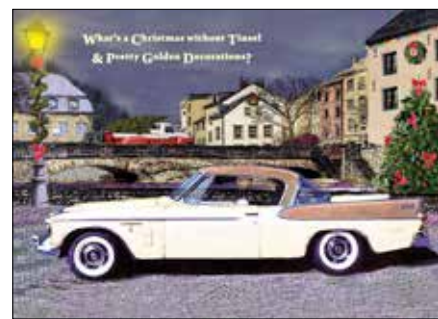
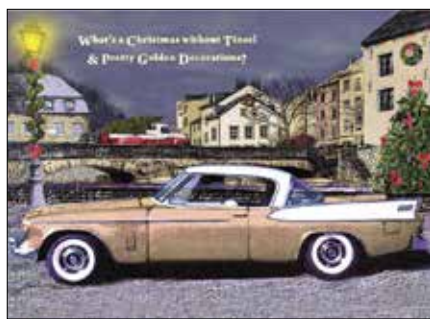

Cover print: "What's a Christmas without Tinsel and Pretty Golden Decorations?" Inside print: Have a Merry Christmas & a Golden New Year"

802168 Gold with white fin.

802168X1 White with gold fin.\$22.00 set/20

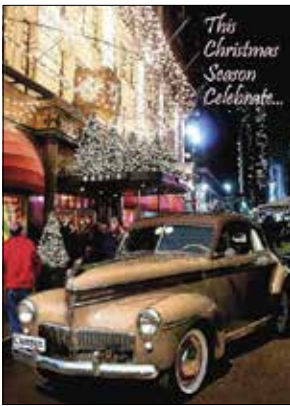

802169
"1941
Champion"

Inside print:
"With Friends,
Family &
Champions!"
5" X 7".

\$22 set/20



802197
"White
Studebaker
Christmas"
Inside print:
"Filled
with Peace,
Love, &
Joy for your
Holiday
Season!"
5" x 7".

\$22 set/20



802216 "1962 GT Hawk" Inside print: "The Best of Cheer, for Christmas & the Coming Year!"
5" x 7" **\$22 set/20**



802170 "1963 Avanti" Inside print: "For a Sleek Stylish Holiday and A Forward Thinking New Year!". 5" x 7" **\$22 set/20**



802171 "1955 Speedster" Inside print: "& a Happy New Year!". 5" x 7" **\$22 set/20**



802195 "1956 Golden Hawk" Inside print: "& a Happy New Year!". 5" x 7" **\$22 set/20**



802365 "Coupe Express" 5x7. Inside print: Wishing you an old-fashioned Christmas and a prosperous New Year **\$19.95 set/20**

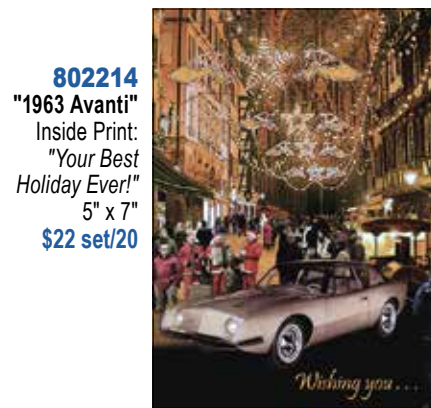

802214
"1963 Avanti"
Inside Print:
"Your Best
Holiday Ever!"
5" x 7"
\$22 set/20

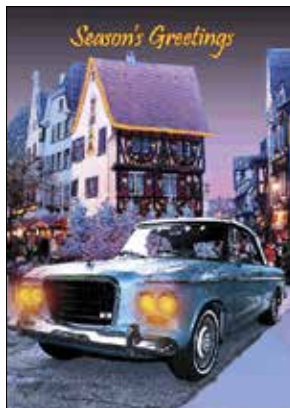

802215
1963 Lark
Inside print:
"And a Happy
New Year!"
5" x 7".

\$22 set/20

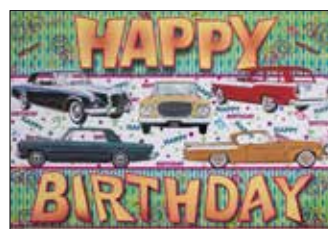

"THE YEARS ARE WHAT MAKE YOU A CLASSIC"

802259 Inside Print: "We know getting older isn't a bad thing. It's just one step closer to being a classic. Happy Birthday!" **\$2.95 ea.**

802259X1 Blank inside **\$2.95 ea.**

802187
"Studebaker
Parade"
5" X 35" Fold out
birthday card.....
..... **\$4.95 ea.**



BIRTHDAY CARDS

"OUR CHAMPION"

802260
5" x 7"

Inside Print:
"To the Classic
Studebaker
Driver,
Enthusiast,
Fan & Owner
Happy
Birthday!"
\$22 set/20

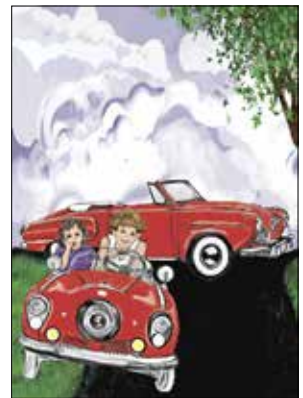

GET WELL CARD

802302

Cover Print: "Sorry that you're under the weather..."

Inside Print: "Hope you're back out on the road again real soon!" **\$2.95 ea.**



COLLECTIBLE AUTOMOBILE MAGAZINES

February 1998

801119 Article "Raymond Loewy and the Birth of the Studebaker Avanti" by Michael Lamm. 10 pages of color and black & white photos and article telling the story of the car, followed by 6-page interview of Avanti designer Tom Kellogg with sketches. Also, 6-page article titled "AVX: Avanti, the Next Generation" containing color sketches & photos. Magazine also has information on Avanti toy models issued throughout the years & a large color photo of the Franklin Mint 1/24 Avanti. Great magazine for Avanti owners..... **\$8.50 ea.**



December 2005



801768 Photo feature 1956 Golden Hawk. 4-page article with color photos. Also, "1928 Erskine 51B Panel Truck: Very Light Delivery." 4-page article with color photos..... **\$8.50 ea.**

CAR CREDENTIAL FOLIO



12-004 Duplicate of original that came with the car when new. Kept in glove box to hold maintenance records, receipts, warranties, etc **\$4.50 ea.**

GLOVE BOX INFORMATION CARDS



801082 1950 Commander & Land Cruiser..... **\$4.95 ea.**



801098 1950-51 Champion..... **\$4.95 ea.**



801387 1941-48 M-series truck **\$4.95 ea.**



801784 1949-53 2-R truck..... **\$4.95 ea.**

802298 If you purchased a new supercharged Studebaker or Packard in 1957 or 1958 it probably came with one of these cards in the glove box. **\$3.50 ea.**



FACTORY PRODUCTION TICKET

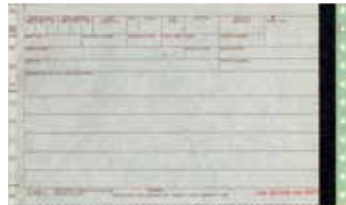

801230 Original blank. Not a reproduction. In 8-part format for all cars & trucks. Fill in with your information..... **\$12.00 ea.**



802221 Original blank 3-part form for trucks. Fill in with your information..... **\$10.00 ea.**

BROCHURES



801395 Studebaker holiday greeting card with offer for a free "Lubrisurance". A unique collectible. 2 sides. 5 1/2" x 8 3/8"..... **\$6.00 ea.**



801396 1950 summer sales flyer promoting accessories & service 8.25"x5.25" folds out to 16.25"x10.5"..... **\$12.00 ea.**



801400 1962 Lark color brochure. Includes features, options & specifications. 10.75"x 7.5" folds out to 15"x 21.5"..... **\$8.00 ea.**



801403 1965 color brochure. Includes features, options, specifications & exterior & interior photos. 8.5"x 11". 12 pages. **\$10.00 ea.**



801404 1966 color brochure featuring model listing options & specifications. 4"x 9 1/4"..... **\$8.00 ea.**

POSTCARDS



801422 In 1964 Studebaker was seeking to improve their corporate image which included updating the appearance of Studebaker dealerships. This 20-page color brochure

was sent to dealers which included suggestions for beautifying their showrooms with new arrangements & signs so that they would have an easily recognizable corporate image.. **\$10.00 ea.**

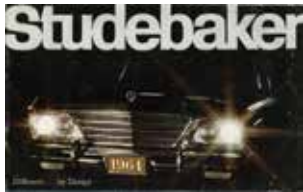

801855 Original 12 page brochure for 1964 Lark, Hawk, and Avanti. Color.

6 1/4" x 4 1/4"..... **\$5.00 ea.**

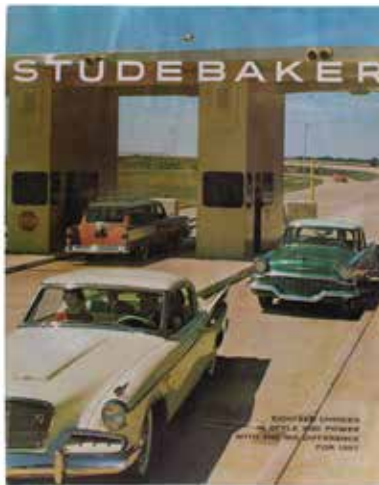

801856 Original 1957 sales brochure. Folds out to 22" x 28". Includes sedans, station wagon, and Hawk. Slightly soiled..... **\$12.50 ea.**

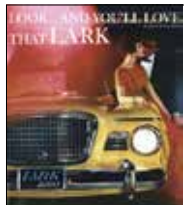

802191 9" x 6 1/2" brochure. Folds out to 18" x 25". Includes all 1960 Lark models..... **\$5.00 ea.**

802212 9" x 6 1/2" brochure. Folds out to 18" x 25". Includes all 1961 car models including Hawk.... **\$5.00 ea.**



- A. **801659** 1981 Avanti II postcard. 8 1/2" x 4" **\$3.00 ea.**
 - B. **801661** 1984-85 Avanti postcard (black) 6" x 4"..... **\$4.00 ea.**
 - C. **801662** 1975 Avanti II postcard. 8 1/2" x 3 3/4" **\$6.00 ea.**
 - D. **801663** 1966 Avanti II postcard. 6" x 9"..... **\$7.50 ea.**
 - E. **802083** 1963 Avanti original factory card **\$1.00 set/2**
- 801681** Set of 5 original Avanti postcards. Includes one of each A through E..... **\$14.95 set/5**



A.



B.



C.



D.



E.



802082 1950 Champion **\$1.00 ea.**

- A. **802222** View of Studebaker's Detroit factories. This is an original card, not reprinted.... **\$3.00 ea.**
- B. **802223** 1959 Lark hardtop. This is an original card, not reprinted. Has printed writing on back as it was used for dealer advertising. .. **\$3.00 ea.**
- C. **802224** 1963 Cruiser. This is an original card, not reprinted **\$3.00 ea.**
- D. **802225** 1961 Lark 2-dr sedan. This is an original card, not reprinted..... **\$3.00 ea.**
- E. **802226** 1961 Lark 4-dr sedan. This is an original card, not reprinted..... **\$3.00 ea.**
- F. **802227** 1960 Lark 4-dr sedan. This is an original card, not reprinted. Has printed writing on back as it was used for dealer advertising..... **\$3.00 ea.**
- G. **802228** 1960 Champ truck. This a recently produced card..... **\$1.00 ea.**
- H. **802229** 1963 Wagonaire. This is an original card, not reprinted..... **\$3.00 ea.**
- I. **802230** 1962 Daytona convertible pace car. This is a recently printed card..... **\$1.00 ea.**
- J. **802231** 1964 Gran Turismo Hawk. This is a recent copy of an original factory photo. **\$1.00 ea.**
- K. **802232** 1940 Commander coupe. This is a recently produced card..... **\$1.00 ea.**

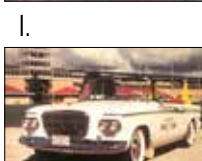

All New Postcards are roughly 5.25" x 3.5"

AVANTI JACK INSTRUCTIONS



800075 Original jacking instructions. Meant to adhere under the spare tire cover.
.....\$4.50 ea.

AVANTI RADIO INSTRUCTIONS

800078 1963-64 Avanti with AM/FM radio. Found in the glove box when the car was new.
.....\$3.50 ea.



AVANTI BROCHURES



800304 Avanti II literature packet. Includes brochures, press releases and price sheets from 1966-81.....
.....\$30.00 ea.

801086 1989 convertible & coupe. 4 pages. Color. 9" X 7.5".....
.....\$6.00 ea.



801087 1989 convertible. 4 pages. Color. 8.5" X 11".....
.....\$6.50 ea.



801088 1990 4-door coupe & convertible. 2 pages with specs 8.5" X 11.5".....
.....\$6.00 ea.



801089 1990 4-door. 6 pages. Color. 8 1/2" X 8 1/2".....
.....\$12.00 ea.

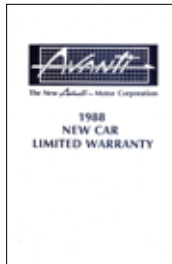
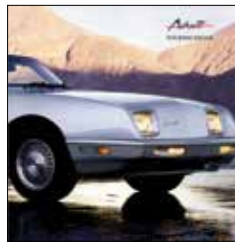

801111 1988 Avanti warranty information.
.....\$18.00 ea.

801340 1989 convertible & coupe. 9" x 12". 8 page folder.....
.....\$18.00 ea.

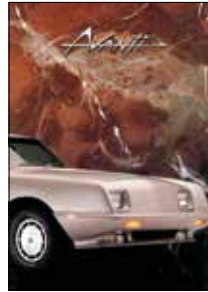

801341 1991 convertible. 2 page ad with specs. 8 1/2" x 11".....
.....\$18.00 ea.

801379 1987 coupe. Stretched coupe & convertible. 2 pages with specs. Color.....
.....\$8.00 ea.



801380 Avanti designer Tom Kellogg standing between an AVX prototype and 1963 Avanti. Copy of Autoweek article covering AVX on back. 2 pages. Black & white.....
.....\$8.00 ea.

801381 AVX color brochure. 5 pages with specs. Color.
.....\$14.00 ea.



801394 1963 Avanti. Original fold out black & white sales brochure. Includes features, interior & exterior photos. 3 3/8" x 7 7/8".....
.....\$5.00 ea.

801656 Auto Week AVX reprinted black and white article with specs. 8 1/2" x 11". 2 pages.
.....\$6.00 ea.



801657 2001 Avanti convertible brochure. Photos and specs. 8 1/2" x 11" Color. 2 pages.....
.....\$6.00 ea.

801658 2001 Avanti coupe brochure. Photos and specs. 8 1/2" x 11". 2 color. 2 pages....
.....\$6.00 ea.

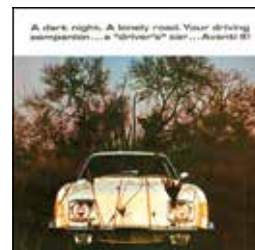

801664 1967, approximately. Avanti II brochure. Includes interior & exterior photos. Color. 9" x 9". 4 pages.
.....\$6.00 ea.

801665 1968, approximately. Avanti II fold out brochure. Includes interior & exterior photos & specs. 4" x 9" folds out to 8 pages. Black & white.....
.....\$10.00 ea



802065 1964 Avanti name plate registration form. When buyers received their 1964

Avanti a form was in the glove box for them to fill out and return to Studebaker to receive their free engraved dashboard name plate. This is an original form and is not reprinted.....
.....\$5.00 ea.

802292 1988 "The Legacy Continues" brochure. Coupe, stretched coupe, and convertible with options and specs. 12 pages.
.....\$16.00 ea.



AVANTI COLOR SAMPLES



801090
1990 Exterior paint chart. Color chips of 11 color choices \$12.00 ea.

801114
1989 Avanti interior, exterior & convertible top color selections. \$12.00 ea.



801415 1963-64 Avanti factory vinyl samples. Includes red, claret, elk, turquoise & black. \$18.00 ea.

AVANTI POSTERS

802029 Reprinted. Avanti speed records poster. 17" x 26" on 30 lb. text weight paper..... \$6.95 ea.



802397
"Renaissance" by Tony Randazzo, 16" x 20" \$5.00 ea.



802363
Fifth in a series. "Time Machines," 16" x 20". \$5.00 ea.



802422 "Little Sister" by Tony Randazzo, 16" x 20" \$5.00 ea.



802423
"Cloverleaf" by Tony Randazzo for Stellar Scholars and A.O.A.I. 16" x 20". \$5.00 ea.



802450
Curtain Call at Casa Loma by Don Wieland \$5.00 ea.



B.



A.



Poster series by Don Wieland

C.



D.



A. **802219** This "Gold out of South Bend" 16"x 20" poster is a tribute to Avanti & its Studebaker, South Bend heritage. Available in limited quantities..... \$5.00 ea.

B. **802251** "Startling Tales". The second in a series of beautiful drawings by this award winning artist. 16" X 20"..... \$5.00 ea.

C. **802299** 3rd in series, "The Whisper & the Road". 16" x 20"..... \$5.00 ea.

D. **802332** 4th in series/ "Ghostriders" 16"x20"..... \$5.00 ea.



800292 "The Legacy Continues" poster. 20" x 37"..... \$12.00 ea.

SUNDAY SERVICE POSTER



801389 "Sunday Service". 20" x 15½" black & white poster. 22" x 29" with white border like original 1950 photo of a pastor giving a sermon from the back of his 2-R truck..... \$8.00 ea. Additional posters sent to same address. \$6.00 ea.

ACCESSORIES GUIDES

Accessory manuals were placed in the glove boxes of cars when new. They included optional factory approved items that were available from the dealer with the intent of gaining some additional sales. Some of the items listed were radios, antennas, rearview mirrors, floor mats, exhaust extensions, seat belts, spotlights, etc.

800247
1964 Avanti. \$12.50 ea



802042
1962 Hawk. Reprinted. \$20.00 ea.

802043
1963 GT Hawk. Reprinted. \$20.00 ea.



802044
1964 Hawk. Reprinted. \$20.00 ea.

802069
1965 Lark. \$20.00 ea.



REPRINTED ACCESSORY MANUALS

802310 1953 car manual..... \$25.00 ea.
802319 1950 car manual..... \$25.00 ea.
802320 1951 car manual..... \$25.00 ea.

Compiled by the Studebaker National Museum, these monographs include a wealth of information on the models they represent. Photographs are included for most models which includes many exterior, interior and engine compartment photos. These monographs answer many questions and are very useful when completing a restoration. Most of the monographs contain:

- Detailed articles on the specified models.
- A listing of available paint color options and codes.
- Production totals for each year by model and body style.
- Specifications for all of the specified models.
- Distinguishing differences between the models.
- Factory service letters.
- A listing of wheel and stripe colors.
- Available accessories with prices.
- A listing of original sales and other literature for each model.
- Starting and ending serial and engine numbers for each year.
- A listing of under hood colors.
- A listing of upholstery fabrics and colors.

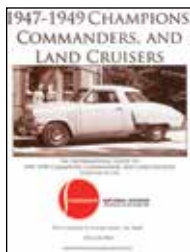

802148
"1947-1949
Champions,
Commanders, &
Land Cruisers"

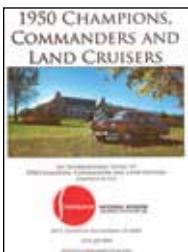

802149
"1950 Champions,
Commanders and
Land Cruisers"

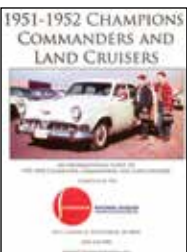

802150
"1951-1952
Champions,
Commanders and
Land Cruisers"

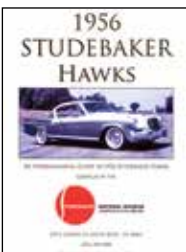

802151 "1956
Studebaker
Hawks - Flight,
Power, Sky &
Golden"

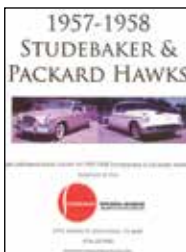

802152
"1957-1958
Studebaker &
Packard Hawks"

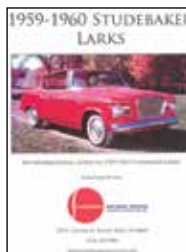

802153
"1959-1960
Studebaker Larks"

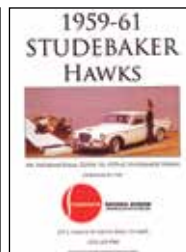

802154
"1959-1961
Studebaker
Hawks"

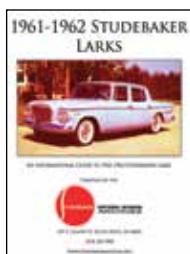

802155
"1961-1962 Stude-
baker
Larks"



802156 "Super
Studebakers -
1963-64 Avanti
Powered Larks &
Hawks"



802157
"The Studebaker
Avanti"

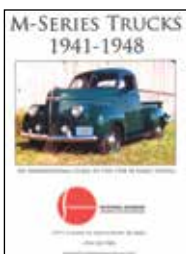

802158
"M-series trucks
1941-1948"

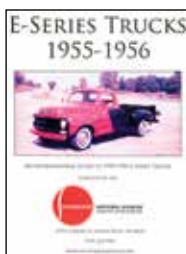

802159
"E-series trucks
1955-1956"

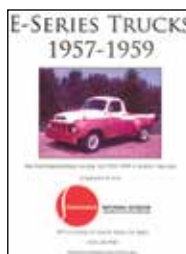

802160
"E-series trucks
1957-1959"



802161
"Transtar trucks
1960-1964"

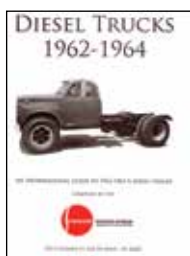

802162
"Diesel" trucks 1962-
1964"

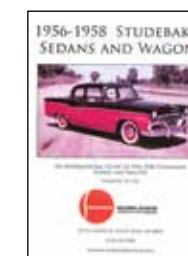

802172
"1956-1958 sedans
& wagons"



802173
"2R & 3R series
trucks 1949-1954"

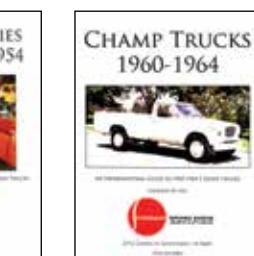

802174
"Champ trucks 1960-
1964"

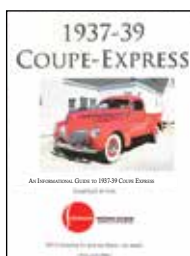

802269
"1937-1939
Coupe Express"

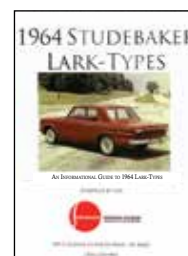

802270
"1964 Lark"



802271
"1965-1966
Lark"

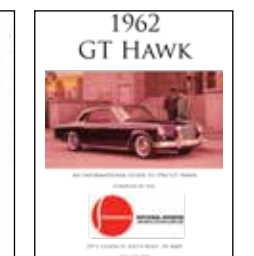

802208
"1962 G.T. Hawk"



802209
"1963-64 G.T. Hawk"



802210
"1963 Lark"

FACTORY FILMS ON DVD

*Studebaker produced films at various times for their dealers or for the public. As part of their Centennial celebration in 1952, three films were created (802376, 802377, 802378) which were shown in movie theatres around the world. These films have fortunately been preserved and transferred to video for all to enjoy.

STUDEBAKER GOES TO WAR VOL. 1: ANSWER TO AXIS



802369 Answer to the Axis: A film chronicling Studebaker's production efforts for World War II including Wright-Cyclone R-1820 aircraft engines and US6 military trucks. B/W, sound. **Truck Testing At Proving Ground:** Footage of US6 testing at the Studebaker Proving Ground, Color, silent.

Army-Navy "E" Award Presentation: Footage of Studebaker receiving the "E" award during a ceremony outside its South Bend plant, Color, silent..... **\$19.95 ea.**

STUDEBAKER GOES TO WAR VOL. 2: THE WEASEL



802370 The Weasel: A promotional film showing the development and testing of the Studebaker-exclusive Weasel. **Weasel Testing in Lake Michigan:** Footage of Weasel Water-testing in Lake Michigan. Color, silent. **Weasel Testing in Swamp:** Footage of a Weasel being tested in a swamp. Color,

silent. **Army-Navy "E" Award Presentation:** Footage of Studebaker receiving the "E" award during a ceremony outside its South Bend plant. Color, silent... **\$19.95 ea.**

STUDEBAKER GOES TO WAR VOL. 3: MORE OF THE WEASEL



802371 T15 Weasel Testing at Pando Colorado: Footage of early Weasel testing Pando, Colorado. Color, Silent. **Early Weasel Testing:** Footage of early Weasel and other military snow vehicles being tested. B/W, silent. **Studebaker Memorial Dedication:** Footage of Studebaker's World War II memorial dedication. Color, silent..... **\$19.95 ea.**

STUDEBAKER'S GOLDEN ERA: EVOLUTION OF A CHAMPION



802372 Evolution of A Champion: Promotional film for Studebaker's 1934 models. B/W, silent. **Separating Facts From Opinion:** Promotional film for Studebaker's 1927-8 models. B/W, silent. **Studebaker Safety (1932):** Promotional film for Studebaker's 1932 models with extensive test footage. B/W, sound. **Star of Motordom (1937):** Promotional film for Studebaker's 1937 models. B/W, silent..... **\$19.95 ea.**

THE 1939-40 STUDEBAKER CHAMPION



802373 Ahead of the Parade: Fictionalized story of the 1939 Studebaker Champion's development in which a newsreel company uncovers information about the Champion's design, engineering, and testing. B/W, sound. **Still Ahead of the Parade:**

Promotional film for the 1940 Studebaker Champion with introduction by Studebaker President Paul Hoffman. B/W, sound..... **\$19.95 ea.**

STUDEBAKER GOES OFF THE HIGHWAY



802374 Desert Explorers: Promotional film for Studebaker's 1949-1950 Desert Explorer models. B/W, sound. **Studebaker on Safari:** Promotional film featuring the 12th Gatti Expedition to Africa, which used Studebaker automobiles. Color, sound. **Desert Explorers - Raw Footage:** Raw footage from Desert Explorers filming. B/W, silent..... **\$19.95 ea.**

A PARTNERSHIP OF FAITH



802375 This is a film about the "partnership" of Studebaker's 20,000 employees and management. Positive portrait of union-management relations. Segments of this film are narrated by one of the employees from each department. Lots of factory footage. 24 minutes. B&W.. **\$13.95 ea.**

STUDEBAKER CENTENNIAL FILMS: VOLUME 1



802376 The Studebaker Story: A Hollywood version of the Studebaker family's entry into the wagonmaking business and its venture into automobiles. Stars Harry Carey, Jr. and John Hamilton. Color, sound. **Last Car of First Century:** Silent footage of the last car of Studebaker's first century leaving the factory and flag raising ceremony. Color, silent. **Studebaker Wins Again:** Coverage of Studebaker's participation in the 1952 Mobilgas Economy Run. B/W, sound..... **\$19.95 ea.**

STUDEBAKER CENTENNIAL FILMS: VOLUME 2



802377 Beyond a Promise: Fictionalized story of a young man, the son of a Studebaker dealer, who attends service school at the Studebaker factory. The young man is impressed not only by the superior product, but by the company's virtues as well. B/W, sound. Also, **Testing 1950**

Models: Silent footage 1950 Studebaker models being tested at the Proving Ground. Color, silent..... **\$19.95 ea.**

STUDEBAKER CENTENNIAL FILMS: VOLUME 3



802378 Family of Craftsmen: The story of the Bokons, a multi-generational family of Studebaker employees that symbolized the many families of craftsmen who worked for the Studebaker Corporation. B/W, sound. **1950 Promo:** Promotional film introducing Studebaker's 1950 models. Hosted by Mike Wallace. B/W, sound..... **\$19.95 ea.**

STUDEBAKER AT THE INDIANAPOLIS MOTOR SPEEDWAY



802379 1952 - Studebaker Celebrates Its Centennial at the Speedway: Newsreel-style production of Studebaker's participation in the 1952 Indianapolis 500. The company provided the pace car and celebrated its centennial during pre-race festivities. BW/color, sound.

1962 Indianapolis 500 - Pre- and Post-Race Festivities: Footage of Studebaker's participation in the 1962 Indianapolis 500. The company provided the pace car and festival cars for the event. Features footage of the #34 and #22 Studebaker Specials from the early 1930's and race winner Rodger Ward. Color, silent. **1964: Paula Murphy/ Studebaker Novi Special:** Footage of driver Paula Murphy in the Studebaker-Novi Special. B/W, silent... **\$19.95 ea.**

THE STUDEBAKER TRANSTAR: STARS OF TRANSPORTATION



802380 Stars of Transportation: Promotional film introducing Studebaker's 1956 Transtar Truck. Color, sound. **Factory Paint Line:** Footage of painting and baking of truck hoods and fenders. Color, silent. **1957 Dealer Driveaway:** Footage of Studebaker's 1957 Spring Dealer Driveaway. Shows

entire 1957 line and a pre-production 1958 Packard Hawk, Color/BW, silent..... **\$19.95 ea.**

STUDEBAKER-PACKARD: THE MID-1950S



802381 Operation Success: Studebaker-Packard - 1957: Segment from the television show Operation Success focusing on the Studebaker Packard Corporation in 1957. Color, sound. **1957 Packard Introduction and Studebaker-Packard Press Conference:** Features S-P President Harold

Churchill and Curtiss-Wright President Roy Hurlay. B/W, sound. **1956 New York Auto Show:** Footage from the 1956 New York Auto Show featuring the Packard Predictor. *Note: Footage is of amateur quality. B/W, silent.* **1954 Studebaker Land Cruiser Crash Test:** Footage from crash test at Studebaker Proving Ground. Color, silent..... **\$19.95 ea.**

MODEL X: THE STUDEBAKER LARK



802382 Model X: Promotional film introducing Studebaker's 1959 Lark Hosted by John Cameron-Swayze. Features Studebaker personalities Harold Churchill, Eugene Hardig, and Duncan McRae. Color, sound. The original film has significant color fade. Do not adjust your television. **1960 Press Preview and**

Dealer Driveaway: Footage of Studebaker's 1960 Press Preview and Dealer Driveaway at the Studebaker Proving Ground. Color, silent. **Festival on Wheels:** Newsreel-style coverage of Studebaker's participation in the 1960 Mobilgas Economy Run. B/W, sound..... **\$19.95 ea.**

FACTORY FILMS ON DVD

STUDEBAKER TODAY (1961-62)



802383 *Studebaker Today:* Corporate promotional film showing Studebaker's products and divisions in 1961. Shows 1962 models in production. Color, sound. **1961-62 Promotional Spots:** Advertising spots for Studebaker's 1961-62 models. B/W, sound... **\$19.95 ea.**

THE 1962 STUDEBAKER: STEP UP WITH STUDEBAKER



802384 *Step Up With Studebaker:* Promotional film for Studebaker's 1962 models. Color, sound. **1962 Studebaker Promotional Spots:** Advertising spots for Studebaker's 1962 models. B/W, sound..... **\$19.95 ea.**

THE 1963 STUDEBAKERS: THE BIG CHANGE



802385 *The Big Change:* Promotional film introducing Studebaker's 1963 models. Color, sound. Note: The original film has significant color shift. Do not adjust your television. **1963 Studebaker Commercials:** Promotional spots for 1963 Studebaker automobiles. B/W, sound..... **\$19.95 ea.**

THE 1964 STUDEBAKERS: DIFFERENT BY DESIGN



802386 *Different By Design:* Promotional film introducing Studebaker's 1964 models. Color, sound. **Studebaker at Bonneville, October 1963:** Footage of Studebaker's October, 1963, Bonneville Salt Flats campaign. Features extensive product placement by the Ashland Oil Company and many shots of the R5 "Due Cento" Avanti. Color, silent..... **\$19.95 ea.**

THE AVANTI: AMERICA'S MOST ADVANCED AUTOMOBILE



802387 *Avanti:* Promotional film introducing Studebaker's Avanti. Color, sound. The original film has significant color loss. Do not adjust your television. **Bonneville Record Breaker:** Promotional film for Studebaker's record setting runs at the Bonneville Salt Flats in August of 1962. Color, sound. **Studebaker at**

Bonneville, January 1963: Footage of Studebaker's January 1963 Bonneville campaign, Color, silent. **Studebaker at Bonneville, October 1963:** Footage of Studebaker's October, 1963, Bonneville Salt Flats campaign. Features extensive product placement by the Ashland Oil Company and many shots of the R5 "Due Cento" Avanti. Color, silent..... **\$19.95 ea.**

STUDEBAKER OF CANADA: ACCENT ON QUALITY



802388 *Accent On Quality:* Promotional film for Studebaker's Hamilton, Ontario, plant, made shortly after it became Studebaker's sole production facility in 1964. Color, sound. **1965-66 Studebaker Promotional Spots:** Advertising spots for Studebaker's 1965-66 models. B/W, sound..... **\$19.95 ea.**

STUDEBAKER'S CLOSING: SEPARATING FACT FROM FICTION



802389 *Studebaker* historians Robert Ebert and Bob Palma and former South Bend Tribune reporter Jack Colwell analyze Studebaker's decline and departure from the automobile business at a January 6, 2014 program hosted by the Studebaker National Museum. This disc also features former Studebaker employees' recollections on the 50th anniversary of the company's closing of its South Bend plant..... **\$19.95 ea.**

Jerry Horne's 1957 Golden Hawk from Union, Illinois.



PHOTO ALBUM

801106

Show off your favorite Studebaker in this personalized photo album. Holds 24, 4"x6" shots off your pride and joy!.....



..... \$5.95 ea.

TRAILER RECEIVER COVER



801427

2" base & 5 1/2" x 3 1/8" Studebaker medallion. Red with white lettering. Plastic base.....

..... \$12.50 ea.

TRAILER HITCH-BALL COVER

801759 Flexible plastic ball hitch cover. Black with white "Studebaker" script. Fits 2 standard trailer balls .. \$4.50 ea.



VALVE STEM CAPS

29-015

Chrome caps for your tire valve stems with Studebaker "S" logo.....



..... \$5.95/set 4

WRAPPING PAPER

Close up view



802265

Nice quality 40 lb. red and white printed wrapping paper. 24" x 25' roll. \$12.50 ea.

BOWS



802266

Emerald green bow with white imprinted "Studebaker" script logo - white. Ribbon 3/4" wide, approximately 4" with 18 loops when puffed. (Comes flat for damage-free delivery) - instructions are included on how to "puff"..... \$2.50 ea.

RIBBON SPOOLS

802267 One roll of 3/4"x28' emerald green metallic foam laminate ribbon with white Studebaker script logo.....



..... \$3.00 ea.

GIFT WRAP SETS



802268

This set includes one roll of red printed paper (802265), one roll of printed emerald green ribbon (802267), & four emerald green "Puff" bows (802266). Retail cost if items purchased separately..... \$25.50/set

SPECIAL PACKAGE PRICE \$19.95/set

FENDER COVERS

Protect your car's finish while working under the hood. Also looks great at car shows when showing off your engine.



800289 "Studebaker — Symbol of Superiority" fender protector..... \$34.95 ea.



800290 Hawk fender protector \$34.95 ea.



800291 Avanti fender protector..... \$34.95 ea.



800919 "Different by Design" fender protector..... \$34.95 ea.



801101 Truck fender protector \$34.95 ea.

SIGNS



N-003
"Mechanic on Duty".
12"X24"
\$25.00 ea.

STUDEBAKER REPAIR PRICE LIST

PING-PING-PING	\$35.00
PLUNK-PING-PLUNK	\$55.00
CLUNK-PING-CLUNK	\$125.00
THUD-KLUNK-THUD	\$200.00
CLANG-THUD-KLANK	\$325.00

© STUDEBAKER NATIONAL MUSEUM • South Bend, Indiana • www.studebakermuseum.org



801368 Welcome sign. Metal..... \$26.00 ea.



Aluminum "Authorized Studebaker Service" circular sign.
802327 11.5 inch (with raised letters) ..
\$24.00 ea.
20-003 23 3/4 inch. Aluminum.....
\$38.50 ea.

802203 "Studebaker Repair Price List". 11"X14" on heavy cardboard..... \$5.50 ea.



N-018 "Studebaker Used Cars & Trucks Sold Here". 6"X24" \$22.50 ea.

802328
Red ball Studebaker logo with raised letters. 11.5 inch (aluminum).
\$24.00 ea.



20-006 "Studebaker Dr." 6"X24". These heavy duty signs are great for office or garage and are long lasting \$22.50 ea.



802496 Metal "Authorized Service/Genuine Parts" 21.5"x11.5" \$27.50 ea.



802010 "Studebaker" sign. For use on back of stake bed, grain bed, dump bed, etc. Red with silver lettering. 3"X18" \$22.50 ea.



20-007 "Studebaker Parking". 18"X12"..... \$22.50 ea.

MEDALLIONS

Adhesive backed domed plastic medallions. These make good award plaques, steering wheel centers, etc.



(A) **26-004** "S" logo. 1-1/2". Black/chrome \$2.00 ea.
(B) **26-006** Avanti logo. 1 3/4". Chrome-black with clear background \$5.00 ea.
(C) **26-007** Studebaker logo. 1 1/8". Red and white \$1.50 ea.
(D) **26-008** Hawk bird logo. 1 1/8". Gold-black \$1.50 ea.

(B) **26-009** Avanti logo. 1 1/8". Black-chrome. \$1.80 ea.
(E) **26-010** Studebaker wheel logo. 1 1/8". Gold-black \$1.50 ea.
(F) **26-011** Truck logo, 1 1/8". White-red \$1.50 ea.

(G) **26-012** Studebaker logo. 1-3/4". Red/blue/white \$2.50 ea.
(C) **26-013** Studebaker logo. 1 11/16". Red/white \$2.00 ea.
(H) **26-014** The Lark by Studebaker logo. Red/white \$2.00 ea.

BUMPER STICKERS



17-001 "Don't laugh... my Studebaker may be worth more than what you drive." \$2.50 ea.



17-002 "Keep America beautiful drive a Studebaker." \$2.50 ea.

22-001 "Studebaker". Red and blue logo on white vinyl. \$5.00 ea.



22-003 "Lark Studebaker". Black on white vinyl. \$5.50 ea.

22-006 "Studebaker" script. Black on white vinyl. \$5.00 ea.



17-003 "Keep on trucking... in a Studebaker truck!" \$2.50 ea.



17-004 "I'd rather be driving my Studebaker." \$2.50 ea.

FRONT LICENSE PLATES



22-007 "Studebaker Hawk". Black on white vinyl. \$5.00 ea.

802307 "Studebaker 100% American" script with flag. Red, blue, and black on white vinyl. \$6.00 ea.



17-005 "Studebaker." \$2.50 ea.



802050 "Bail out Studebaker" \$2.50 ea.



802323 "Studebaker We'd rather fix than switch" \$2.50 ea.

22-009 "Studebaker Racing" with logo. Red, blue, and black on white vinyl. \$5.00 ea.



801452 "Gran Turismo Hawk". Black on white vinyl. \$5.00 ea.

LICENSE PLATE FRAMES METAL

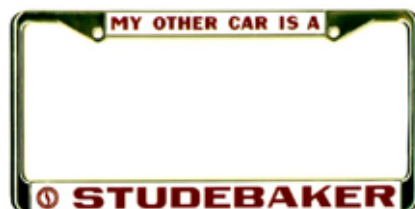

750072 "My other car is a Studebaker" \$9.50 ea.

KEY RINGS

NOTE: Keys are sold separately.



802123 Bulletnose \$7.50 ea.

- B) 15-006 Avanti logo \$5.50 ea.
- A) 15-007 Studebaker \$5.00 ea.
- C) 15-010 Studebaker wheel \$5.00 ea.
- D) 15-012 Hawk \$5.00 ea.
- E) 15-014 Studebaker Truck \$5.00 ea.

802124 Studebaker Drivers Club. \$5.00 ea.



15-019 Lark. \$5.00 ea.



KEY CHAINS



802324 Avanti logo. It looks like a small chrome connecting rod & piston but is really a key chain with an Avanti logo on top. \$6.00 ea.



802325 Studebaker red ball piston key chain \$6.00 ea.

HOW ABOUT MAKING THE LOOK COMPLETE WITH STUDEBAKER KEYS?

Ignition keys - page 133 • Glove box keys - page 40 • Trunk keys - page 133-134

AVANTI MODEL



800309 AMT 1/25 scale model kit of a 1963-64 Avanti with over 120 parts.....**\$15.00 ea.**

STARLINER MODEL

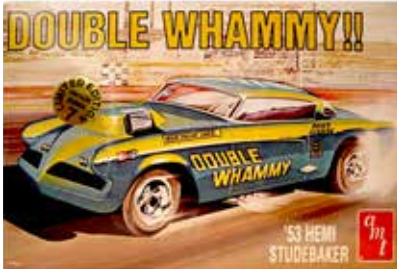

800053 AMT 1953 Starliner hardtop. This stock 1953 Commander V-8 comes ready to assemble with opening hood & V-8 engine. Interior & chassis are both detailed as original. Can also be built as a Double Whammy drag or custom car with included parts.....**\$15.00 ea.**

1950 CHAMPION



Yat Ming 1/18 scale 1950 Champion. Finally a model of this popular Studebaker! Opening doors and hood with detailed engine compartment. Folding seat and working steering wheel:
802511 Dark blue.....**\$54.95 ea.**
802511x2 Green.....**\$54.95 ea.**

VINTAGE GAS PUMPS

Studebaker gas pump. 5" tall. Metal. Gift boxed.

- (A) **801799**
\$6.50 ea.
- (B) **801800**
\$6.50 ea.



1951 COMMANDER



Highway 61, 1951 Studebaker Commander 1/18 scale die-cast model. 11" long, opening hood, trunk, doors, side vents, glove box & gas lid door. Detailed engine, working steering wheel.

Available in 4 colors.....**\$44.95 ea.**
801465..... Sierra Tan with visor

STUDEBAKER TOY TRUCK



Yat Ming 1/18 scale 1937 Coupe Express truck. Opening doors and hood with detailed interior and engine compartment. Wheels turn with steering wheel.

801483 Burgundy.....**\$32.00 ea.**
801483x1 Green.....**\$32.00 ea.**
801483x2 Red.....**\$32.00 ea.**

1963 AVANTI



Avanti 1/32 scale model with opening doors and hood. Good detail & original Avanti factory colors Available in:
801556X1 Avanti white.....**\$12.50 ea.**
801556X3 Avanti Black.....**\$12.50 ea.**

FLYING SAUCER



29-003 Throw it, catch it, enjoy it! Fun for adults and kids. White 9" saucer with blue Studebaker wheel logo..... **\$3.50 ea.**

STUDEBAKER MOUSE PADS



802199 Red ball logo. 8" Mouse pad....
**\$8.50 ea.**



801103 Now you and your computer can have the ultimate mouse pad. Red, white & blue 'S' logo imprinted with "Studebaker". We've also added all of our information so you can keep our numbers handy. A great addition to your desk. This mouse pad has our old address.....**\$4.25 ea.**

1957 GOLDEN HAWK



Yat Ming 1/43 scale 1957 Golden Hawk
**\$8.00 ea.**
801702X1 Green with white fin
801702X2 Black with gold fin
801702X3 Burgundy with white fin
801703 White with gold fin

802037 Johnny Lightning Limited Edition 1/64 die cast replica of 1957 Golden Hawk with dark green body and light green fin. Good detail and nicely boxed in a special collectors tin. Also includes special Johnny Lightning 10th Anniversary Club Pin. This is a very nice model that all Studebaker enthusiasts will appreciate receiving. Limited quantities.....
**\$15.00 ea.**



1957 Golden Hawk. 1/18 scale. Good quality diecast model with opening doors and hood. Steering wheel turns front wheels.....**\$32.00 ea.**
801363X1 White
801363X2 Orange with white fin
801363X5 Silver with white fin

1953 STUDEBAKER STARLINER



In 1953 Studebaker introduced the Starliner, a revolutionary new car. The Starliner, known as the "Loewy Coupe" changed the face of modern automotive design. Now masterfully recreated in die cast metal with over 110 parts. Opening doors, hood and trunk. Every detail has been carefully recreated down to the steering wheel emblem. A miniature masterpiece**\$35.00 ea.**
801683X1 Olympic gray over Tahoe green
801683x3 Dark blue over light blue

1950 CHAMPION PEN



800513 A 1950 Champion convertible floats by the dealership. Cute, a practical conversation piece. You'll have to see to fully appreciate.
.....\$3.50 ea.

TRUCK PEN



800934 R-series truck floats down the road. A novelty you'll enjoy sharing with your friends.
.....\$3.50 ea.

AVANTI PEN



800974 America's most advanced automobile, the Avanti, floats down a Palm Springs street.
.....\$3.50 ea.

801069R Set of six pens. You choose from the three styles listed above. Please specify which styles when ordering.\$18.00 set/6

801682 Extra ink refill for pens. Black ink.
.....50¢ ea.

CUSTOM MADE PATCHES

New custom made patches, about 6" long
\$20.00 ea.



(A) **802426** Golden Hawk, white/gold



(B) **802427** Golden Hawk, gold/white



(C) **802428** Avanti

EMBROIDERED PATCHES



16-001

Gold Hawk design on white background with gold border.
\$3.50 ea.

16-004

"Studebaker" red ball design. 3"
\$3.50 ea.



16-006

"Authorized Studebaker Service". Red, white, & blue. 3".
\$3.50 ea.



16-005

Gold Hawk bird. Yellow logo with white letters on red. 3".
\$3.50 ea.



16-007

"S" design. Red, white, & blue. 3"
\$3.50 ea.

16-008

"Studebaker" wheel. Gray, blue, & black. 3", \$3.50 ea.



16-009

"Avanti". Red, white & blue parallelogram. 1 1/2" X 4" \$3.50 ea.



16-011 "Studebaker". Red border & blue letters on white background. 1" X 4 1/2" \$3.50 ea.



16-011X1 Blue letters & border on white background. 1" X 4 1/2" \$3.50 ea.



16-012

1950-1957 "Studebaker" crest. \$3.50 ea.

16-014

"Studebaker Trucks". Red & white. 3" \$3.50 ea.



16-015

"Gran Turismo Hawk by Studebaker" 3". \$3.50 ea.



16-027 "Studebaker Car Nut" patch. Red, white, & blue. 2" X 4 3/4" \$3.50 ea.



16-028 Embroidered

"Studebaker" script iron-on patch. Gold logo \$5.00 ea.

16-029 Embroidered "Studebaker" script iron-on. Silver logo \$5.00 ea.



16-032

"Studebaker Wagons" red, green, yellow & white, 3".
.....\$4.00 ea.



16-033

Genuine Studebaker Parts, Accessories, red, white \$4.00 ea.

UMBRELLAS

Full size umbrella with Silver "Studebaker" script and simulated wood handle.
\$28.15 ea.



15-015A
Maroon with silver lining

15-015
Blue with silver lining

TRAVEL BLANKET

802338 Made of a sturdy cotton and polyester jersey fabric, like a warm cozy sweatshirt, this wrinkle resistant 50"x58" blanket easily folds to



store under the seat or in your trunk. Great to drape over the seat or over your legs during car shows, spread on the ground for picnics or wrap around your shoulders on cold days when you're star gazing with the convertible top down. Navy with white Studebaker script logo \$30.99 ea.

EMBROIDERED PATCHES



801630 "Studebaker" patch. Red, White, Blue & Gold .. **\$3.50 ea.**

802165 "Studebaker Drivers Club" patch. 3.5" diameter **\$3.50 ea.**



STUDEBAKER TUMBLERS



801641 Attractive 14 oz. glass tumbler set. Gold rim with Studebaker script logo in blue. Nicely gift boxed in sets of 4 **\$36.00/set 4**

SHOT GLASSES



Shot glasses with attractive "Studebaker" logos..... **\$3.95 ea.**

- 802140x1** "Studebaker" wheel.
- 802140x2** "Studebaker" red ball.
- 802140x3** "Studebaker Authorized Service".

INSULATED CUPS

801108 Attractive 21 oz. insulated plastic cup with granite-like finish, a sip-thru lid and sporting the "Studebaker" logo **\$9.25 ea.**



POT HOLDER

15-017 Save your hands from those nasty, nasty burns with this Studebaker pot holder. Mom will love 'em..... **\$8.65 ea.**



STUDEBAKER MUGS

800751 Attractive "Studebaker" design in red on gray mug. **\$6.75 ea.**



800751X6 Set of 6 **\$39.95 set/6**



802141 "Studebaker National Museum" mug. White mug with red logo on both sides for left and right hand users..... **\$5.95 ea.**

DRINK INSULATORS



800762 Keep your cold drinks cold with these attractive foam drink holders. Available in an assortment of bright colors with white wheel logos **\$3.00 ea.**

800762X6 Set of six **\$15.00 set/6**

HAT - TIE - LAPEL PINS

800985 Red or black 1953 hardtop..... **\$3.50 ea.**



800896 Yellow or black 1950 bulletnose..... **\$3.50 ea.**



800897 White, red or black Avanti **\$3.50 ea.**



800898 "Authorized Studebaker Service" logo..... **\$3.50 ea.**

800899 Red, white & blue "S" emblem..... **\$3.50 ea.**



800900 Gold "Studebaker" script..... **\$5.00 ea.**

800901 Gold "Avanti" script..... **\$5.00 ea.**



800902 Gold Hawk bird..... **\$3.50 ea.**

800903 "Studebaker Sales & Service" **\$3.50 ea.**



800978 "Authorized Service, Genuine Parts" **\$3.50 ea.**

800979 Red or black truck. Side view **\$3.50 ea.**



800980 Red or black truck. Front view..... **\$3.50 ea.**

801053 "Studebaker Street Rod" **\$3.50 ea.**



801829 Bulletnose..... **\$3.50 ea.**

1956 Golden Hawk. **802038** White/tan..... **\$3.50 ea.**



802038X1 Red..... **\$3.50 ea.**

802038X2 Black..... **\$3.50 ea.**



802430 "Avanti", red, white & blue **\$3.50 ea.**



AVANTI T-SHIRT



Black T-shirt with white logo.
For men & women.

- S: **800086**.....\$14.50 ea.
- M: **800085**.....\$14.50 ea.
- L: **800084**.....\$14.50 ea.
- XL: **800083**.....\$14.50 ea.
- XXL: **800282**.....\$16.00 ea.

CHILDREN'S T-SHIRT



Black T-shirt with white Avanti logo for boys and girls.
2-4: **800090**.....\$13.50 ea.
6-8: **800089**.....\$13.50 ea.
10-12: **800088**.....\$13.50 ea.
14-16: **800087**.....\$13.50 ea.

ORNAMENTS

- 802116X1** Gold bulb with red ball logo..... **\$9.00 ea.**
- 802116X2** White bulb with Santa & his truck. Backside has red "Studebaker" script with "Merry Christmas" on back. See 802261 for appearance..... **\$9.00 ea.**
- 802116X3** White bulb with "S" red ball design & "Season's Greetings" in green wreath..... **\$9.00 ea.**
- 802116X4** White bulb with "Authorized Studebaker Service" logo. Backside has red "Studebaker" script with "Merry Christmas" on back. See 802261 for appearance. **\$9.00 ea.**
- 802116X5** Metallic blue bulb with red, white, and blue "S" logo **\$9.00 ea.**
- 802116X7** White bulb with "Studebaker" wheel logo. **\$9.00 ea.**
- 802116X8** Green bulb with "Studebaker" script..... **\$9.00 ea.**
- 802257** 1963 Avanti with snowman. Backside has red "Studebaker" script with "Merry Christmas" on back. See 802261 for appearance **\$9.00 ea.**
- 802258** GT Hawk with Santa and Reindeer. Backside has red "Studebaker" script with "Merry Christmas" on back. See 802261 for appearance..... **\$9.00 ea.**
- 802261** Red bulb with white script logo & Merry Christmas. Both sides printed with same design. **\$9.00 ea.**
- 802262** Black bulb with white and red "S" logo. Backside has red "Studebaker" script with "Merry Christmas" on back. See 802261 for appearance..... **\$9.00 ea.**

BELT BUCKLES



800018
Studebaker wheel logo, brass **\$22.00 ea.**



800920
Copy of original Studebaker harness strap buckle, brass..... **\$18.00 ea.**



SUSPENDERS

800970 Good quality red suspenders with "Studebaker" in white lettering and white wheel logo on each strap. For men & women..... **\$19.95 pr.**

STUDEBAKER WHEEL T-SHIRT

Black T-shirt with white Studebaker wheel logo. For men & women.

- S: **800070**..... **\$12.00 ea.**
- M: **800069**..... **\$12.00 ea.**
- L: **800068**..... **\$12.00 ea.**
- XL: **800067**..... **\$12.00 ea.**
- XXL: **800295**..... **\$16.00 ea.**

CHILDREN'S T-SHIRT

Black T-shirt with white Studebaker wheel logo. For boys & girls.

- 2-4: **800074**..... **\$10.50 ea.**
- 6-8: **800073**..... **\$10.50 ea.**
- 10-12: **800072**..... **\$10.50 ea.**
- 14-16: **800071**..... **\$10.50 ea.**

STUDEBAKER LANYARD



802445 White lanyard with black Studebaker script..... **\$2.75 ea.**

JEWELRY



- 800131** Tie-tac..... **\$6.50 ea.**
- 800133** Necklace..... **\$6.50 ea.**
- 800135** Earrings. Clip on..... **\$8.50 ea.**
- 800136** Earrings. Pierced..... **\$8.50 ea.**



- 802113** "S" logo necklace..... **\$6.50 ea.**
- 802114** "S" logo earrings. Clip on..... **\$8.50 ea.**
- 802115** "S" logo earrings. Pierced..... **\$8.50 ea.**

BLUE DENIM HAT



Blue denim hat with embroidered logo. Good quality! For men and women.

- 801624** Studebaker logo..... **\$31.70 ea.**

STUDEBAKER RACING GOLF SHIRTS



Golf shirt with pocket. Light Blue. For men and women.

- 802003** M..... **\$24.95 ea.**
- 802004** S..... **\$24.95 ea.**
- 802005** XL..... **\$24.95 ea.**
- 802006** XXL..... **\$26.95 ea.**

STUDEBAKER LOGO T-SHIRT WITH POCKET



Be the first to sport this Studebaker pocket T-shirt. White "Studebaker" logo on nice quality black shirt. For men & women.

S:	801801	\$18.99 ea.
M:	801773	\$18.99 ea.
L:	801774	\$18.99 ea.
XL:	801775	\$18.99 ea.
XXL:	801776	\$23.95 ea.
XXXL:	801802	\$23.95 ea.

NEW SWEAT PANTS



S:	802339X1	\$34.40 ea.
M:	802339X2	\$34.40 ea.
L:	802339X3	\$34.40 ea.
XL:	802339X4	\$34.40 ea.

AVANTI SWEATSHIRT



Black sweatshirt with white Avanti logo on black shirt. For men & women.

S:	800227	\$29.99 ea.
M:	800226	\$29.99 ea.
L:	800225	\$29.99 ea.
XL:	800224	\$29.99 ea.
XXL:	800284	\$29.99 ea.



BLACK BEANIE HAT

802111
Black beanie hat with white embroidered "Studebaker" script. One size fits all.....**\$12.00 ea.**



STUDEBAKER SOCKS

You will look your best wearing these socks with "Studebaker" woven into the knit. For men or women with choice of color and size.

White with blue letters:

9-11:	800933X1	\$8.50 pr.
10-13:	800933X2	\$8.50 pr.

Navy with red letters:

9-11:	800933X3	\$8.50 pr.
10-13:	800933X4	\$8.50 pr.

GRAY T-SHIRT



Gray T-shirt with attractive red & blue logo. For men & women.

M:	800591	\$14.50 ea.
L:	800592	\$14.50 ea.
XL:	800593	\$14.50 ea.
XXL:	800594	\$15.95 ea.

LADIES V-NECK T-SHIRT

Avanti logo



S:	802352X1	\$14.95 ea.
M:	802352X2	\$14.95 ea.
L:	802352X3	\$14.95 ea.
XL:	802352X4	\$14.95 ea.

LADIES BLACK SCOOPED NECK T-SHIRT WITH WHITE WHEEL LOGO



S:	802348X1	\$14.95 ea.
M:	802348X2	\$16.75 ea.
L:	802348X3	\$14.95 ea.
XL:	802348X4	\$14.95 ea.

BABY ONSIES



Check out this delivery! Adorable 100% cotton baby romper has a unique green "Studebaker" logo. Soft white color with white zig-zag stitching on sleeves and collar. Snap-leg closure with added room for diaper comfort.

- 3-6 mo: **801769** \$14.95 ea.
- 6-12 mo: **801770** \$14.95 ea.
- 12-18 mo: **801771** \$14.95 ea.
- 18-24 mo: **801772** \$14.95 ea.

SUNGLASSES



15-016 Metal frames, soft plastic nose piece, and white "Studebaker" script logo. \$13.95 ea.

GOLF SHIRTS



Gray golf shirt with embroidered "Studebaker" logo. Shirt has pocket. For men & women.

- L: **801384** \$25.00 ea.
- XL: **801385** \$25.00 ea.



Burgundy golf shirt with embroidered "Studebaker" logo. Shirt has pocket. For men & women.

- M: **800602** \$25.00 ea.
- L: **800603** \$25.00 ea.
- XL: **800604** \$25.00 ea.

FLIP FLOPS



\$13.95 pr.

- 802479X1** Black, small
- 802479X2** Black, medium
- 802479X3** Black, large
- 802479X4** Black, x-large

- 802481X1** Blue, small
- 802481X2** Blue, medium
- 802481X3** Blue, large
- 802481X4** Blue, x-large

- 802480X1** Red, small
- 802480X2** Red, medium
- 802480X3** Red, large
- 802480X4** Red, x-large

HOODIE



Gray hoodie with red Lark logo on back. For men & women.



- S: **802485X1** \$34.95 ea.
- M: **802485X2** \$34.95 ea.
- L: **802485X3** \$34.95 ea.

- XL: **802485X4** \$34.95 ea.
- XXL: **802485X5** \$39.95 ea.

HATS



Light weight mesh style hat with embroidered "Studebaker" logo. For men & women.

- 800051X1** Red. Pictured above.
- 800051X2** Black
- 800051X3** Blue \$16.50 ea.

STUDEBAKER WHEEL SWEATSHIRT



Black sweatshirt with white wheel logo. For men & women.

S:	800332	\$29.99 ea.
M:	800333	\$29.99 ea.
L:	800334	\$29.99 ea.
XL:	800335	\$29.99 ea.
XXL:	800336	\$33.90 ea.

"THROUGH THE YEARS" T-SHIRT



BACK VIEW

Ash shirt with multi-color design depicting Studebaker wagons to the Avanti. Design is on both front and back of shirt. For men & women.

M:	800922	\$13.95 ea.
L:	800923	\$13.95 ea.
XL:	800924	\$13.95 ea.
XXL:	800925	\$15.95 ea.

STUDEBAKER CHAIR



801498 It'll be perfect at the next Studebaker meet sitting next to your car on this handy foldup chair with the "Studebaker" logo on the back. Take anywhere and enjoy. Includes a built-in drink holder and carrying case. Chair is blue with white logo **\$59.95 ea.**

NECKTIE



801522 Quality silk blend necktie. Navy blue with red "Studebaker" script logo woven into the cloth. A quality tie that you'll be proud wearing for business as well as social functions **\$29.95 ea.**

BLACK COTTON HAT WITH BROWN SUEDE BILL

For men and women. Denim.

800486	Avanti logo	\$16.50 ea.
---------------	-------------	-------	-------------



AMC

STEERING PARTS

G105603 Steering gear housing expansion plug, 1959 Rambler, 20-80a ...
..... \$0.75 ea.

GLOVE BOX

- 900000** Insert, 1937 Nash Ambassador \$50.65 ea.
- 900001** Insert, 1939 Nash \$48.30 ea.
- 900002** Insert, 1939 Nash Ambassador \$50.65 ea.
- 900003** Insert, 1940 Nash Lafayette \$48.30 ea.
- 900004** Insert, 1942-47 Nash \$48.30 ea.
- 900005** Insert, 1949 Nash \$48.30 ea.
- 900006** Insert, 1952-1953 \$79.60 ea.
- 900007** 1954-62 Metropolitan \$48.95 ea.
- 900008** Insert, 1959 Rambler \$48.30 ea.
- 900009** Insert, 1960 Rambler & Rebel \$48.30 ea.
- 900010** Liner, 1960 Rambler American \$9.25 ea.
- 900011** Insert, 1963-1964 Ambassador & Classic \$33.00 ea.
- 900012** Insert, 1964-1969 Rambler \$29.85 ea.
- 900013** Insert, 1965-66 Rambler Ambassador & Classic \$38.05 ea.
- 900014** Insert, 1967-72 Rebel, Matador & Ambassador \$29.85 ea.
- 900015** Insert, 1967-85 Grand Wagoneer & Truck \$48.30 ea.
- 900016** Insert, 1968-86 CJ \$29.00 ea.
- 900017** Insert, 1970 AMX \$30.90 ea.
- 900018** Insert, 1970-77 Hornet & 1970-76 Gremlin (w/glove box door)
..... \$27.95 ea.
- 900019** Insert, 1970-71 Gremlin (w/o glove box door) \$25.65 ea.
- 900020** Insert, 1974-78 Matador & 1974 Ambassador \$48.30 ea.

HUDSON

HUDSON SHOP MANUALS

802498 1942-1947 \$65.00 ea.

TRANSMISSION PARTS

G105602 Transmission case expander plug, 1955-1956, 355-356, 40, 50,
60 \$0.20 ea.

ENGINE PARTS

- G106326** Timing cover to block screw for models 355-356, 80
..... \$1.00 ea.
- G107828** Connecting rod bolt pal nut for models 355-356, 40-60
..... \$0.25 ea.

CHEVROLET

BRAKE PARTS

1553241 Brake booster firewall boot for 1963-1972 Truck \$11.50 ea.

RETURNING PARTS?

Do not forget a copy of your invoice with your return!

There is a **\$5.00** "Invoice Search" fee for items returned without an invoice.

PACKARD

PACKARD PARTS MANUALS

- 801299** 1922-28 Sixes, 1st to 5th Series Illustrated, Numerical Index, 126-133-226-233-326-333-426-433-526-533. 374 pages. **\$40.00 ea.**
- 801300** 1922-29 Eights, 1st to 6th Series Illustrated, Numerical Index, 136-143-236-336-343-443-626-633-640-645. 450 pages. **\$40.00 ea.**
- 801301** 1930-32 Eights, 7th to 9th Series (Except Light Eight) Illustrated, Numerical Index, 726-733-740-745-826-833-840-845-901-902-903-904. 280 pages **\$35.00 ea.**
- 801302** 1932 Light Eight **\$22.50 ea.**
- 801303** 1932-36 Twelves, 9th to 14th Series 905-906-1005-1006-1107-1108-1207-1208-1407-1408. 450 pages **\$45.00 ea.**
- 801304** 1933-36 Eights, 10th to 14th Series 1001-1002-1003-1004-1100-1101-1102-1103-1104-1200-1201-1202-1203-1204-1205-1400-1401-1402-1403-1404-1405. 500 pages **\$55.00 ea.**
- 801305** 1935-41 Six, 120; 1939-41 Super Eight Illustrated, Numerical Index, Utility Section. Six: 115C-1600-1700-1800-1900-T1900-DE1900. Eight: 120A, 120B-BA, 120C-CA-CD, 138CD, 1601-A-D-2, 1701-A-2, 1801-A, 1901-A Super. Eight: 1703-A-5, 1803-A-4-5-6-7-8, DE1903, 1903-A-4, 1905-6-7-8. 620 pages **\$50.00 ea.**
- 801306** 1937-38 Super Eight & 1937-39 Twelves Illustrated, Numerical Index. Super Eight: 1500-01-02, 1603-04-05. Twelve: 1506-07-08, 1607-08. 500 pages **\$55.00 ea.**
- 801307** 1941-47 Clipper Illustrated, Numerical Index. Six: 1942-47, 2000-10, 2100-30. Eight: 1941-47, 1951, 2001-11, 2101-11. Super Eight: 1942-47, 2003-06, 2103-06-26. 360 pages **\$35.00 ea.**
- 801308** 1942 Twentieth Series. 110, 120, 160, 180. 225 pages. **\$30.00 ea.**
- 801309** 1948-54 Master Parts Book. All models, Illustrated, Numerical Index. 916 pages **\$65.00 ea.**
- 801310** 11948-50 henny, Body Parts Book. 110 pages **\$18.00 ea.**

PACKARD OWNER'S MANUALS

- 801312** 1935 One-Twenty\$22.50 ea.
- 801313** 1936 One-Twenty\$22.50 ea.
- 801314** 1937 Six.....\$22.50 ea.
- 801315** 1937 One-Twenty\$22.50 ea.
- 801316** 1937 Super Eight.....\$22.50 ea.
- 801317** 1938 Six\$22.50 ea.
- 801318** 1938 Eight.....\$22.50 ea.
- 801319** 1938 Super Eight & Twelve.....\$22.50 ea.
- 801320** 1939 Six.....\$22.50 ea.
- 801321** 1939 Eight\$22.50 ea.
- 801322** 1939 Super eight & Twelve\$22.50 ea.
- 801323** 1940 Senior Models, 160-180. **Note:** Same as Preliminary Shop Manual\$22.50 ea.
- 801324** 1941 Junior Models, 110-120. **Note:** Same as Preliminary Shop Manual\$22.50 ea.
- 801325** 1941 Senior Models, 160-180. **Note:** Same as Preliminary Shop Manual\$22.50 ea.
- 801426** 1940 Junior Models, 110-120. **Note:** Same as Preliminary Shop Manual\$22.50 ea.

TRANSMISSION PARTS

- 458502** Overdrive solenoid, 1955-1956 All models\$265.00 ea.
- 531067** Overdrive solenoid, 1949-1954 All models \$260.00 ea.
- 185368** Overdrive indicator light bulb, 1940-1942 All models\$1.25 ea.
- 188659** Overdrive indicator light bulb, 1946-1947 All models, 1948-1949 22nd series\$1.00 ea.
- 6470203** Main shaft rear oil seal and overdrive tail shaft seal for 1939 SU. 8\$8.00 ea .

ELECTRICAL PARTS

- 293764** Parking light bulb, 1933-1939 All seniors..... \$1.75 ea.
- 185368** Parking light bulb, 1935-1939 All seniors.....\$1.25 ea.
- 110527** Tail light bulb. All seniors. Also license light for 1930-39 models.\$1.75 ea.

BRAKE PARTS

- S-379** Master cylinder repair kit for 1937-38 SU. 8 and 37-39 V-12, 1946-47 Model 2126, 1939-54 Henley all models\$71.25 ea.
- 683453** Front wheel cylinder repair kit for 1937-38 SU. 8 and 37-39 V-12 ..\$14.25 ea.
- 1693964** Rear wheel cylinder repair kit for 1937-38 SU. 8 and 37-39 V-12, 1951-56 all models.....\$11.60 ea.

PACKARD SERVICE LITERATURE

- 801285** 1922-28 1st to 5th Service Manual. PART 1: Standard Specifications (Outline of Procedures). PART 2: Standard Service Practices. Covers all models. but not every section applies to every model. 500 pages.\$45.00 ea.
- 801286** 1929 Sixth Series Service Manual. PART 1: Standard Specifications (Outline of Procedures) Covers 626-633-640-645 with a cross reference index for most 7th to 9th series models. 500 pages\$35.00 ea.
- 801287** 1930-35 Service Letters, 7th to 12th Series. A collection of the mechanical information articles published in the dealer service letters, compiled by Packard. 200 pages\$30.00 ea.
- 801288** 1935-36 Technical Data Book. Covers the One-Twenty 120 pages\$22.50 ea.
- 801289** 1936 Service Manual, All models. 70 pages.....\$18.50 ea.
- 801290** 1936-44 Service Letters, 14th thru 20th Series. A collection of the mechanical information articles published in the dealer service letters. Compiled by Packard. 300 pages.....\$40.00 ea.
- 801291** 1937-38 Service Manual. Covers all models. NOTE: In the past we printed the 1937 independently from the 1938-39 models, however, this manual covers the 1937 models better than the 1937 Service Manual so we have decided to print this manual for 1937 manuals. 145 pages\$20.00 ea.
- 801292** 1938-39 Service Manual. Covers all models. Recommended for 1938 models. NOTE: Packard did not issue complete shop manuals for 1940 or 1941; they did print the owner's manuals with a cover which said "Preliminary Shop Manual". Please see Packard owners manuals for them. 152 pages\$20.00 ea.
- 801293** 1942 Service Manual, all models. 130 pages.....\$22.50 ea.
- 801294** 1946-50 Shop Manual Chapters. Seven chapters published separately during this period, in 6"x9" format. (Original size) Perfect Bound. 448 pages.\$40.00 ea.
- 801295** 1949-50 Ultramatic Transmission Serviceman's Training Books Part 1 & 2. 100 pages\$20.00 ea.
- 801296** 1951-54 Shop Manual, All models. 500 pages.....\$55.00 ea.
- 801297** 1955-56 Shop Manual, All models. 500 pages\$55.00 ea.
- 801298** 1955-56 Twin Ultramatic Transmission. 80 pages\$15.00 ea.

INTERIOR PARTS

DOOR PANEL FOUNDATION

- 802501** 1938-39 model 110 with window surrounds\$75.00 pr.
- 802502** 1951-52 model 250 coupe & convertible.....\$70.00 pr.

AC-88	202	G113897	160	S-335X1	271, 279	6-004.....	9
AC-294	30	G114496	241, 272, 273, 274	S-336X1	271, 277	6-005.....	9
AC-1051	196	G114988	217	S-346.....	160	6-009.....	8
AC-1400	18	G116102	236	S-349.....	271	7X34.....	279
AC-1400X	18	G120151	187	S-358.....	271	8-001.....	9
AC-1433	196	G120369	223	S-358X1	271	9-001.....	9
AC-1445	41	G124545	227	S-367.....	271	9-002.....	9
AC-1637	18	G124549	280	S-367X1	271	10-001.....	9
AC-1638	18	G124896	29	S-368.....	271	10-002.....	9
AC-1822	132	G124934	274	S-371.....	184	11-001.....	9
AC-1826	20	G125619	131	S-372.....	184	11-002.....	9
AC-1852	20	G127934	197	S-374.....	254	11-003.....	9
AC-1853	18	G131282	197	S-375.....	254	12-001.....	10
AC-1853X	18	G132848	237	S-376.....	254	12-002.....	10
AC-2029	178	G137422	219	S-377.....	254	12-003.....	10
AC-2118.....	19	G138631	236	S-378.....	255	12-004.....	298
AC-2340	18, 121, 122, 123, 126	G142450	197	S-379.....	255	12-005.....	10
AC-2340X.....	18	G142456	197	S-381.....	255	13-001.....	10
AC-2344	22	G143999	284, 287	S-387.....	254	13-002.....	10
AC-2408	172	G144235	20	S-388.....	254	13-003.....	10
AC-2426	132	G145636	239	S-628.....	218	13-004.....	10
AC-2703	172	G145637	248	S-629.....	218	13-005.....	10
AC-2704	120, 121, 122, 123, 124, 125, 126, 127, 128, 172	G145641	235, 259, 272, 273, 274	S-630.....	218	14-001.....	10
AC-2728	18, 121, 122, 123, 124, 125, 126, 128	G145643	239, 240	S-632.....	218	14-003.....	9
AC-2728X.....	18	G147487	231	S-641.....	218	15-006.....	307
AC-2754	124, 128, 164	G147685	188	S-642.....	218	15-007.....	307
AC-2771	164	G156112.....	132	S-682.....	218	15-010.....	307
AC-2799	19	G156145.....	132	SP-50057.....	161	15-012.....	307
AC-2831	196	G156617.....	43	SP-50079.....	132	15-014.....	307
AC-2838	32	G157105.....	188	1-027.....	8	15-015.....	309
AC-2840	120, 121, 124, 125, 126, 127, 164	G157277.....	131	1-061.....	8	15-015A.....	309
AC-2855	91	G161791.....	29	1-062.....	8	15-016.....	314
AC-2886.....	32	G179816.....	238	1-063.....	8	15-017.....	310
AC-2918.....	18, 120, 121, 126, 127	G179817.....	238	1-064.....	8	15-019.....	307
AC-2918X.....	18	G179890.....	284, 287	1-081.....	8	15-025.....	39, 44, 130
AC-2957	195	G181364.....	229	1-082.....	8	15-025A.....	39, 128, 129
AC-2973	208	G181637.....	180	1-083.....	8	15-025B.....	39, 45, 128, 129, 130
AC-2987	173	G187385.....	275	1-084.....	8	15-026.....	39
AC-3052	18	G191350.....	276, 277	1-085.....	8	15-027.....	39, 46
AC-3052X.....	18	G191358.....	277	1-086.....	8	15-035.....	33
AC-3053	18	G191758.....	280, 283, 286	1-087.....	8	15-035A.....	33
AC-3199	195	G271288.....	260	1-088.....	8	15-035B.....	33
AC-3218	195	G272121.....	272, 273, 274, 275	1-089.....	8	16-001.....	309
AC-3300	161	G272852.....	183, 187, 188, 189	1-091.....	8	16-004.....	309, 310
AC-3310.....	18, 118, 119, 120, 121	G441261.....	237	1-093.....	8	16-005.....	309
AC-3310X.....	18	G441272.....	157	1-094.....	8	16-006.....	309
AC-3311	161	G443753.....	276, 277, 279, 281	1-095.....	8	16-007.....	309
AC-3330	32	G444672.....	287	1-096.....	8	16-008.....	309
AC-3339	118, 119, 164	G444734.....	274	1-097.....	8	16-009.....	309
AC-3417	196	G444746.....	275	1-100.....	8	16-011.....	309
AC-3456	132	G444752.....	284	1-101.....	162	16-011X1.....	309
AC-3488	195	G444860.....	180	1-102.....	200	16-012.....	309
AC-3516.....	91	G451228.....	178	1-103.....	8	16-014.....	309
AC-3522.....	195	G451236.....	187	1-104.....	8	16-015.....	309
G102895.....	279	G451244.....	187	3-001.....	9	16-027.....	309
G103026.....	222	G453593.....	245	3-002.....	9	16-028.....	309
G103348.....	286, 287	G453674.....	244	3-003.....	9	16-029.....	309
G103565.....	231, 232, 233	G454176.....	41	3-004.....	9	16-032.....	309
G103865.....	272, 273	G454573.....	54	3-005.....	9	16-033.....	309
G103869.....	284, 287	G454645.....	197	3-006.....	9	17-001.....	307
G103883.....	284, 286, 287	G454646.....	197	3-007.....	8	17-002.....	307
G103887.....	287	G454666.....	54	3-012.....	9	17-003.....	307
G105036.....	286	G455136.....	197	3-013.....	9	17-004.....	307
G105602.....	316	G456326.....	43	3-014.....	9	17-005.....	307
G106751.....	279	G9413436.....	54	3-015.....	177	19-002.....	10
G107828.....	157	J-1644.....	251	5-001.....	9	19-012.....	10
G109350.....	276, 277, 283	J-2044.....	270	5-002.....	9	19-012C.....	10
G110161.....	222	J-5473.....	259	5-003.....	9	19-017.....	10
G110347.....	276	N-003.....	306	5-004.....	9	19-019.....	10
G111616.....	183	N-018.....	306	5-005.....	9	19-020.....	10
G111622.....	183	S-333.....	281	5-006.....	9	19-021.....	10
		S-333X1.....	271, 281	6-001.....	8	19-022.....	10
		S-334.....	271	6-002.....	9	20-003.....	306
		S-334X1.....	271	6-003.....	9	20-006.....	306

20-007.....	306	1848X29.....	61, 64, 67	159239.....	251	185015.....	249
22-001.....	307	1863X17.....	65, 66, 67	159243.....	251	185048.....	280
22-003.....	307	1882X1.....	62, 70, 71, 74, 76, 79, 80, 81, 82	165010.....	271, 277, 279, 281	185075.....	164
22-006.....	307	1917X3.....	38	165048.....	263, 286	185166.....	250
22-007.....	307	1942X1.....	59, 68, 69, 70, 79	165052.....	264	185368.....	197, 317
22-009.....	307	1942X2.....	59, 70, 71, 72, 73, 74, 75, 84	165133.....	266	185480.....	251
24-001.....	10	1954X1.....	47	165167.....	263, 284, 286, 287	185483.....	255
25-001.....	10	1962-64.....	20	165391.....	282	185792.....	270, 277, 281
25-002.....	10	1992X1.....	61, 70, 79	167033.....	152	186547.....	197
26-004.....	306	2009X1.....	59, 69, 71, 75, 135	167156.....	156	186666.....	163
26-006.....	306	2030X1.....	59, 63	167480.....	264	186668.....	156
26-007.....	306	2035X1.....	59, 68, 69, 70, 72	167984.....	165	186688.....	156
26-008.....	306	2035X4.....	59, 73, 74	168653.....	164	186693.....	156
26-009.....	306	2046X7.....	132	170052.....	165	186694.....	156
26-010.....	306	2049X20.....	37	170200.....	265	186695.....	156
26-011.....	306	2081X7.....	187	170513.....	279	186702.....	156
26-012.....	306	2082X1.....	222	171513.....	277	186703-4.....	156
26-013.....	306	3035X2.....	130	171777.....	205	186705.....	57
26-014.....	306	3080X2.....	160	171780.....	205	186710.....	160
29-015.....	120, 121, 122, 123, 124, 125, 126, 127, 128, 305	3081X2.....	187	172436.....	164	186711.....	184
41X32.....	178	3081X10.....	188	172622.....	160	186888.....	185
42X102.....	223	3091X2.....	274, 275	173125.....	165	187003.....	164
63X19.....	285	3096X2.....	198	173254.....	202	187069.....	176
63X33.....	263	3096X4.....	198	173649.....	165	187171.....	162
260-12.....	275	3096X5.....	198	174330.....	263	187333.....	160
716-02.....	275	3096X6.....	198	174837.....	162	187481.....	221
718-04.....	275	3096X7.....	130, 198	175967.....	203	187483.....	221
738-04.....	275	3112X2.....	74, 82, 87	176203.....	204	187510.....	165
1048X4.....	60, 128, 129, 130	3139X2.....	60, 74, 75, 76, 77, 78, 79, 80, 81, 82, 83	176208.....	205	187627.....	263
1093X54.....	93, 129, 130	3148X1.....	187	176226.....	204	187637.....	221
1112XB.....	59	3161X3.....	198	177034.....	161	187640.....	221
1284XAE47.....	60	3161X5.....	198	177644.....	266	187641.....	221
1284XAE66.....	60, 63	3167X1.....	59, 78, 79	177731.....	165	187642.....	221
1284XAE84.....	60, 62	3177X3.....	60, 84	177976.....	164	187646.....	221
1284XAE84.5.....	60	3183X1.....	91	178200.....	152	187748.....	173
1284XAE88.....	60	3202X2.....	84	178230.....	164	187844.....	58
1284XAE88.5.....	60	3207X2.....	60, 84	178270.....	164	188102.....	264
1284XAE94.....	60, 62	3235X1.....	62, 80, 81, 83	178804.....	173	188279.....	226
1294X2.....	60, 63	3260X1.....	59, 84	179233.....	227, 231, 232	188282.....	227
1296X60.....	20	3305X2.....	89	179369.....	163	188284.....	227
1296X614.....	20	3305X3.....	130, 193, 198	180054.....	165	188285.....	227
1296X622.....	20	05602 Tra.....	316	180437.....	152, 153	188287.....	227
1458X12.....	93	28777.....	139	180747.....	227, 231, 232	188289.....	227
1463X1.....	50	28778.....	139	180879.....	165	188291.....	227, 231, 235
1479.....	61	43494.....	164	181233.....	157	188295.....	226, 231, 235
1483X1.....	141	80043.....	12	181647.....	281	188296.....	230, 234
1523X39.....	193	110527.....	197, 317	181782.....	285, 287	188298.....	226, 230, 234
1526X47.....	37	122825.....	223	181794.....	266, 285	188348.....	226, 227, 228
1526X58.....	37	123577.....	204	181844-5.....	212	188349.....	227, 228
1578X34.....	193	125917.....	202	182064.....	156	188350.....	227, 228
1581X6W.....	87	125920.....	203	182075.....	160	188351.....	227, 228
1590X1.....	59, 62, 63	127013.....	263, 266	182076.....	160	188367.....	227, 231, 235
1590X2.....	59, 62	127366.....	182	182084.....	156	188383.....	227
1590X3.....	59	127404.....	165	182271.....	202	188384.....	227
1590X4.....	59, 63	128270.....	183	182698.....	222	188385.....	227
1592X1.....	60, 62	130408.....	263	182898.....	261	188494.....	223, 227
1592X2.....	60, 62	130980.....	264	183080.....	279	188521.....	227, 228, 232, 233, 235
1592X3.....	60, 62	130983.....	264	183640.....	165	188522.....	227, 228, 232, 233, 235
1624X1.....	62, 63, 64, 65, 66, 67, 68, 69, 70, 71, 72, 73, 75, 76, 77, 78, 79, 81, 83, 84	130984.....	264	183898.....	157	188523.....	227, 228, 232, 233, 235
1654X1.....	59	130986.....	264, 277, 279, 280, 281, 282, 283	183903.....	266	188524.....	227, 228, 232, 233, 235
1654X2.....	59, 62	131026.....	92, 193, 211	183904.....	266, 285	188541.....	229, 232, 233
1680X1.....	59	131569.....	203	184098.....	184	188620.....	204
1680X2.....	59, 64, 65, 66, 67	131971.....	205	184161.....	284, 285, 287	188622.....	204
1706X6.....	71	134030.....	223, 226, 228, 231, 232, 233, 235	184173.....	261	188626.....	204
1763X1.....	59, 65, 66, 67	140706.....	271	184256.....	165	188628.....	204
1770X1.....	61, 64, 67, 70, 79	151606.....	221	184291.....	222	188645.....	163
1770X2.....	61, 70	155157.....	258	184442.....	152	188659.....	197, 317
1810X17.....	61, 64, 67	156526.....	164	184618.....	165	189113.....	203
1835X3.....	51	156682.....	266	184619.....	165	189133.....	273
1835X10.....	84	156684.....	266	184620.....	165	189143.....	272, 273, 274
1835X30.....	61, 69	159238.....	251	184651.....	152	189144.....	272, 273, 274
1838X10.....	51			184778.....	164	189145.....	272, 273, 274
				184805.....	286	189215.....	221
				184808.....	275	189216.....	221

189218.....	221	192258.....	184	194844-6.....	284, 286, 287	196911.....	58
189232.....	221	192302.....	223, 226, 227, 231, 233	194845.....	263	196930.....	264
189233.....	221	192306.....	226, 230, 234	194846.....	263	196931.....	264
189316.....	160	192545.....	188	194854.....	284, 285	196937.....	213
189393.....	165	192688.....	19	194894.....	19	196952.....	221
189696.....	255	192689.....	19	195058.....	206	196965.....	284, 285, 286, 287
189820.....	162	193032.....	208	195059.....	206	197042.....	272, 273, 274
189888.....	173, 219	193047.....	287	195208.....	277	197090.....	277
190032.....	266, 284, 285, 287	193058.....	227	195211.....	277	197106.....	272
190033.....	266, 284, 285, 287	193060.....	226, 230	195227.....	224	197108.....	272, 273, 274
190035.....	266, 284, 285, 287	193089.....	227	195228.....	221	197109.....	272, 273, 274
190036.....	266, 284, 285, 287	193117.....	229	195231.....	221	197118.....	253
190037.....	285	193122.....	227	195275.....	276, 277	197120.....	253
190038-41.....	284, 285, 287	193129.....	251	195284.....	265	197157.....	261, 277
190047.....	266, 285, 287	193134.....	261, 276, 277	195286.....	162	197192.....	227
190048.....	266, 285, 287	193383.....	261, 276	195304.....	160	197216.....	263, 284, 286
190085.....	214	193384.....	261, 276	195402.....	220	197221.....	229
190260.....	272	193804.....	203	195407.....	186	197222.....	229
190276.....	259, 272, 274	193831.....	277	195428.....	161	197223.....	228
190277.....	272	193878.....	265	195470.....	255	197225.....	228
190426.....	204	193884.....	276	195528.....	227	197230.....	226
190461.....	204	194031.....	203	195551.....	221	197231.....	229
190883.....	229	194035.....	203	195568.....	249	197234.....	226, 230, 234
190893.....	229	194036.....	203	195569.....	250	197239.....	228, 229, 231, 232, 233, 235
190895.....	229	194211.....	264	195616.....	162	197240.....	228, 229, 231, 233, 235
190896.....	229	194212.....	264	195716.....	179	197241.....	228, 229, 231, 233, 235
190897.....	229	194214.....	264	195801.....	152, 153	197242.....	228, 229, 233, 235
190912.....	229	194215.....	264	195802.....	92	197246.....	226
190917.....	229, 232, 233	194216.....	162	195803.....	92	197248.....	227
190918.....	229	194217.....	162	195897.....	270	197250.....	227
190919.....	229	194219.....	156	195919.....	218	197251.....	227
190926.....	229	194247.....	270	195920.....	218	197252.....	227
190927.....	229	194263.....	227	195948.....	204	197256.....	226
190928.....	229	194264.....	227	195950.....	221	197263.....	227
190929.....	229	194272.....	227, 228, 229, 231, 233, 235	195999.....	179	197266.....	229
191047.....	156	194275.....	227, 231, 235	196046.....	270	197267.....	228
191078.....	208	194276.....	227, 231, 235	196080.....	221	197269.....	226
191088.....	152, 153	194288.....	264	196126.....	162	197270.....	228
191135-6.....	281	194289.....	264	196141.....	226	197271.....	226
191202.....	279, 280, 281, 282	194290.....	264	196143.....	226	197273.....	226
191223.....	221	194324.....	157	196181.....	229	197275.....	228, 229, 232
191236.....	221	194347.....	270	196182.....	229	197276.....	223, 227, 231
191409.....	221	194348.....	157	196183.....	226, 229, 232, 233	197285.....	226
191618.....	221	194359.....	163	196184.....	229	197287.....	226, 230, 234
191619.....	221	194373.....	276, 277	196197.....	229	197288.....	226
191622.....	221	194392.....	270	196198.....	229	197299.....	158
191623.....	221	194401.....	268	196286.....	266, 284, 285	197304.....	218
191679.....	270, 277, 281	194484.....	156	196287.....	266, 284, 285	197305.....	226
191703.....	264	194525.....	251	196308.....	264	197306.....	226, 231, 235
191707.....	285, 287	194526.....	251	196309.....	264	197307.....	204
191723-6.....	286, 287	194542.....	157	196313.....	284, 285	197310.....	204
191786.....	221	194557.....	221, 222	196414.....	163	197313.....	204
191787.....	221	194562.....	44, 221, 247	196420.....	220	197320.....	205
191789.....	221	194601.....	221	196562.....	255	197323.....	227
191804.....	276	194603.....	221	196567.....	157	197324.....	227
191805.....	276	194604.....	221	196591.....	277	197346.....	176
191806.....	276	194643.....	221, 222	196592.....	276, 277	197376.....	226
191828.....	221	194644.....	221	196593.....	258, 277	197385.....	277
191829.....	152	194650.....	221	196638.....	268	197389.....	173
191833.....	258, 276	194658.....	185	196643.....	269	197413.....	165
191921.....	206	194660.....	185	196646.....	161	197426.....	276, 277
191922.....	206	194665.....	157	196655.....	163	197436.....	264, 284, 286, 287
191929X1.....	205	194697.....	250	196661.....	163	197476.....	221
191939.....	204	194702.....	253	196662.....	163	197482.....	161
191968.....	272	194826.....	263, 286	196673.....	214	197563.....	19
191971.....	276	194833.....	284, 285	196693.....	164	197565.....	218, 227, 231, 235
191984.....	183	194834.....	284, 285	196709.....	185	197570.....	285
192125.....	160	194835.....	284, 285	196712.....	268	197591.....	156, 263, 286, 287
192136.....	160	194836.....	284, 285	196717.....	152, 153	197592.....	160
192181.....	221	194838.....	284, 285	196741.....	212	197650.....	258, 277
192238.....	263, 266, 286, 287	194839.....	263, 284	196788.....	255	197654.....	277
192239.....	263, 266, 286, 287	194840.....	285	196821.....	272, 273	197655.....	277
192245.....	214	194841.....	263, 284, 285, 287	196859.....	271	197665.....	227, 231, 235
192247.....	214	194844.....	263	196897.....	28	197666.....	227, 231, 235

197736	277	199430	270	272610	197	284117	55
197787	272	199435	221	272617	198	284117X1	55
197789	272	199480	221	272829	143	284212	132
197801	272	199481	221	272985	43	284299	255
197809	221	199485	165	273537	196	284344	138
197861	285	199493	221	273700	47	284345	182
197918	258, 276	199621	221	273701	48	284385	139
197924	276	199654	184	274017	60, 62	284500	59, 65, 66, 67
198020	276	199861	276, 277	274191	59, 62	284501	59, 65, 66
198061	213	199938X1	33	274292	134	284502	59, 65, 66
198074	258, 276	199952	183	274438	47	284505P	88, 222
198076	276	199954X1	205	274439	47	284506	132
198077	276	199992	251	274466	143	284526	88
198078	276	207206	100	274467	143	284528	55
198079	276	252643	259	274472	198	284528X1	55
198082	276, 277	256410	91	274477	141	284594-5	61, 65, 66, 67
198118	220	261419	64, 65, 66, 67, 68, 69, 70, 71, 72, 73, 74, 75, 76, 77, 79	274519	59	284596	50
198123	272	261419 F	172	274527	182	284597	50
198127	272	263122	48	274850	139	284650	40
198180	261, 276, 277	263123	48	274852	139	284662	145
198258	276	263528	193	274906	88	284686	132
198408	165	265164	131	274907	88	284687	132
198436	272	265165X	131	274974	62, 63, 64, 65, 66, 67, 68, 69, 70, 71, 72, 79, 88, 141	284798	131
198441	272	265166	131	275965	138	284799	131
198503	165	265167	131	275966	138	284842	47
198526	255	265325	59	275967	138	284843	48
198579	261, 276	265339	47	276526	193	284844	47
198588	261, 276, 277	265340	48	276575	59	284845	48
198650P	188	265488	59	278416	41	284869	59, 65, 66, 67
198653	188	265595	133	278430	144	284937	61
198685	262, 265	265709	50	278431	144	284956	259
198769	221	265879W	50	278432	144	284977W	134
198770	221	266180	132	278433	144	284990	184
198777P	188	266584	88, 222	278437	144	284991	60, 64, 65, 66, 67, 68, 69, 70, 71, 72, 79
198779	218, 226, 228	266807	48	278618-9	61, 62, 63	284995W	184
198784	226	266907	59	278943X1	43, 44	285005P	128, 129, 130, 185
198816	221	266937	60, 62, 63	278986	40	285030	47
198877	221	266952	59	280789	47	285120-1	172
198910	176	267313	43	280821	47	285155X	192
198964	226	267415	139	280862	144	285177	192
198967	226	267543	139	281042	48	285181	198
198968	226, 231, 234	267544	139	281043	48	285187	192, 193
198970	226, 231, 235	268428	50	281089	47	285192	192, 193
198971	226	268487	50	281096	47	285196	198
198972	227	268488	50	281097	48	285197	197
198973	227, 231	269087	40	281130X3	209	285300	61
198985	228	269426	139	281149	197	285315	196
198987	228	269465	139	281306	139	285393	196
198988	229	269466	139	281307	139	285394	196
198989	229	269687P	139	281398	139	285439	196
198990	229	269907	196	281399	136, 139	285484	48
199035	206	269908	196	281618	197	285485	48
199111	226, 231, 235	269939	211	281637	141	285621	138
199140	163	270164	40	281910	50	285636	59, 67
199203	261	270541	140	281911	50	285637	59, 67
199204	261	270812	47	282012	197	285641	209
199207	261, 276, 277	270813	48	282124	48	285649	143
199208	261, 276, 277	270822	48	282125	48	285722	54
199212	261	270823	48	282172	196	285723	54
199213	261	270965	59, 62	282173	196	285758	213
199218	161	271149	132	282340	143	285810	138
199220	221, 222, 223	271237	132	282341	143	285901	196
199222	221	271284	198	282364	144	285914	197
199228	221	271302	40	282618	138	285927W	22
199230	221	271322	132	282619	138	285946	139
199235	255	271323	132	282661	59, 62	285968	128, 129, 130, 198
199251	227	271441	132	283170	196	285974	193
199282	227	271475	62, 63, 65, 66, 67, 68, 69, 71, 72, 73, 75, 76, 77, 78, 84	283378	48	286026	144
199304	221	271959W	43, 44	283379	48	286105	88
199378	270	272078	62, 63, 84, 172	283600	59	286107W	21
199379X1	263, 284, 285, 287	272358	59	284106	143	286108W	21
199385	270	272359	59	284116	55	286124	40
199388	270	272586	193	284116X1	55	286144	139

286181.....	138	289739.....	197	292389.....	143	296796.....	131
286202.....	184	289760.....	194	292416.....	144	296797.....	131
286226W.....	22	289790.....	47	292417.....	144	296915X2.....	54
286291.....	50	289791.....	48	292439.....	144	296915X2B.....	54, 121, 122, 123
286292.....	50	289792.....	48	292530.....	143	297284.....	138
286388.....	144	289793.....	48	293009.....	55	297290.....	145
286389.....	144	289794.....	47	293009X1.....	55	297463P.....	141
286647.....	128, 129, 172	289795.....	48	293026.....	59, 65, 66	297525.....	55
286660.....	47	289796.....	47	293027.....	59, 65, 66	297568.....	144
286661.....	48	289797.....	48	293050.....	196	297569.....	144
286662.....	48	289798.....	48	293065P.....	134	297572.....	197
286663.....	48	289799.....	48	293071P.....	91	297573.....	197
286681.....	40	289827.....	134	293076.....	134	297644.....	132
286748.....	47	289830.....	138	293087.....	259	297680.....	50
286749.....	48	289838.....	196	293170X3.....	26	297702.....	131
286869.....	131	289859.....	196	293230.....	138	297703.....	131
287019.....	134	289864.....	63, 64, 65, 66, 67, 68, 69, 70, 71, 72, 88, 137	293234.....	139	297726V.....	23
287022.....	198	289872W.....	134	293237.....	196	297772V.....	23
287038W.....	134	289873W.....	134	293338.....	198	297774.....	198
287039.....	133	289885.....	198	293392.....	134	297776.....	138
287068.....	198	289886.....	197	293459.....	86	297796.....	142
287186.....	131	289939.....	194	293580.....	140	297800WP.....	21, 112, 113, 121, 122
287187.....	131	290124.....	139	293608.....	133, 134, 135	297803X6.....	43
287334.....	64	290126.....	139	293684.....	211	297814.....	48
287427.....	40, 44, 45, 64, 69, 70, 79, 141	290127.....	139	293687.....	211	297815.....	48
287499.....	133	290162.....	184	293694.....	138	297820.....	138
287499X.....	133	290165X3.....	184	293712P.....	184	297880.....	134
287524.....	139	290239P.....	184	293749.....	211	297881.....	128, 129, 133
287528.....	40, 44, 45, 63, 64, 65, 66, 67, 88	290242.....	195	293762.....	92, 186	297908.....	22, 113, 123
287533.....	217	290248.....	139	293764.....	197, 317	297912.....	100
287540P.....	86	290249.....	139	293770.....	40	297913.....	100
287541P.....	86	290296W.....	51	293778X2.....	194	297925V.....	23, 112, 121
287648.....	184	290297W.....	51	293805.....	20	297926V.....	112, 122
287693W.....	120, 121, 122, 123, 124, 125, 126, 127, 128	290356.....	51	293830.....	131	297938.....	132
287890.....	139	290486.....	182	293831.....	131	297939.....	132
287891.....	139	290488.....	138	293902X5.....	88	297965.....	55
287974W.....	50	290635.....	40, 134	293902X6.....	88	298012WP.....	21
287975W.....	50	290661W.....	51	293902X7.....	88	298051.....	143
287981X1.....	39	290662W.....	51	293987.....	22	298056.....	143
288584.....	50	290688.....	51	294063X1.....	184	298057.....	143
288585.....	51	290689.....	51	294387.....	55	298060.....	40
288586.....	51	290712.....	22	295796.....	51	298082.....	40
288588.....	51	290722.....	40	295838.....	211	298083.....	40
288609.....	64	290723.....	40	295918.....	128, 129, 130, 135	298128.....	211
288657-8.....	21	290815.....	141	295929.....	195	298146.....	142
288694.....	213	291020.....	40	295930.....	197	298270-1.....	88
288757.....	141	291035.....	40	295945.....	52	298300.....	120, 121, 122, 123, 124, 125, 126, 127, 128
288766.....	138	291059.....	273	296060.....	55	298301W.....	120, 121, 122, 123, 124, 125, 126, 127, 128
288767W.....	21	291060.....	273	296060X1.....	55	298316.....	121, 122, 123, 124, 125, 126, 127, 128, 131
288955.....	213	291068.....	259	296061.....	55	298319.....	121, 122, 123, 124, 125, 126, 127, 128, 131
288956.....	213	291097P.....	184	296061X1.....	55	298340.....	61, 128, 129, 130
289126.....	140	291106.....	42	296062.....	55	298350.....	131
289138.....	141	291188.....	211	296062X1.....	55	298351.....	131
289140.....	144	291209X1.....	39	296130.....	48	298352.....	131
289142.....	144	291209X2.....	39	296131.....	48	298353.....	131
289191X3.....	43	291209X3.....	39	296175.....	197	298354.....	131
289247.....	182	291389.....	86	296206.....	138	298355.....	131
289290.....	43	291504P.....	86	296263.....	182	298385.....	182
289336.....	133	291505P.....	86	296266.....	55	298402.....	139
289337.....	133	291508P.....	86	296275.....	198	298403.....	139
289415.....	138	291509P.....	86	296291W.....	194	298582.....	51
289501.....	143	291590.....	273	296313.....	196	298609.....	144
289509.....	22	291601.....	144	296342.....	21	298675VP.....	21, 112, 113, 121, 122
289526.....	172	291624.....	61	296343.....	21	298746W.....	23, 112, 113, 121
289546.....	138	292050.....	255	296389.....	21	298747.....	42
289575.....	138	292120.....	192	296403.....	89	298824P.....	26
289580.....	182	292141.....	89	296407W.....	22	298825.....	40
289638.....	198	292143.....	89	296457.....	134	298908W.....	51
289639.....	198	292266-7.....	64, 67	296514G.....	93, 141	298909W.....	51
289640.....	182	292286X1.....	54	296580.....	195	298910.....	51
289710.....	173	292287X1.....	54	296728.....	132	298911.....	51
289731.....	198	292387B.....	54	296794.....	131		
		292388.....	143	296795.....	131		

298912X1	50	304294	51	307192	100	308508	93, 94
298912X2	50	304478	49	307193	100	308509	93, 94
298913X1	50	304479	49	307196	100	308510	93, 94
298913X2	50	304642	53	307197	100	308590	49
298915X1	50	304643	53	307199	100	308613	138
298920	51	304646	53	307202	100	308627	145
298921	51	304647	53	307203	100	308644	141
298922X2	51	304649	53	307209	100	308664	101
298923X2	51	304656	143	307211	100	308665	101
298960	196	304771	43, 44, 45, 46	307212	100	308747	88
298965	60, 64, 65, 66, 67, 68, 69, 70, 71, 72, 73, 74, 75, 79, 84	304784	100	307213	93, 94, 98	308748P	88
298968X2	194	304785	100	307312	47	308752	101
298969X2	194	304804	61	307313	48	308753	101
298974	131	304810	142	307316*	47	308790	133
298976	134	304820V	23	307317	48	308791	133
298977	134	304823W	23, 113, 121, 122	307320	48	308907P	88
298989	134	304825V	23, 113	307321	48	308910W	21, 123
299057	20	304827VP	23, 113, 122	307328	100	308911V	21, 123
299079	88	304829W	23, 113, 121, 122, 123	307528	100	308943	60
299169	196	304830V	23, 113, 115, 121, 122	307529	100	308957	198
299170	198	305100	135	307532	100	308958	194, 196
299175V	23	305101	135	307533	100	308959	196
299175W	23	305139	135	307542	211	308960	196
299182	52	305162	135	307546-7	61, 70, 79	309177	140
299183	52	305163	135	307559	87	309198	101
299184	52	305173	135	307590	133	309199	101
299444	23, 113, 123	305176	135	307630	134	309325	93
299589W	21, 112, 113, 122, 123	305177	135	307954	89	309327	93, 94
299754	89	305188	135	308010	55	309338	93, 94
299765	143	305189	135	308011	55	309343	40
299774	37	305206	135	308018	142	309349	198
299777	89	305218	54, 135	308019	142	309404	140
299824-5	70	305220	135	308066	101	310075	211
299845	133	305221	135	308067	101	310123	48
299845X	133	305330	135	308084P	143	310124	47
299850	61, 128, 129, 130	305335	135	308093	138	310125	48
300964	196	305350	135	308098	197	310126	47
300965	194	305351	135	308099	197	310127	47
303047	53	305358	135	308147P	139	310149	39
303068P	88	305406	135	308156	138	310216	211
303151	55	305409	135	308168	131	310266	144
303152	55	305411	135	308169	131	310267	144
303201	131	305453	135	308223	138	310268	144
303366	51	305453	135	308226X2	194	310298	88
303367	51	305662	135	308227X1	194	310299	88
303370X1	50	305748	141	308227X2	194	310425X1	211
303372X1	50	305842	135	308244	101	310425X2	211
303392-3	61, 69	306000	131	308245	101	310486	94
303446	182	306020	20	308260	101	310512	101
303557	87	306055	198	308261	101	310513	101
303568	103	306076X2	194	308272	101	310702	50
303584-5	37	306077X2	194	308273	101	310703	50
303586WP	23, 112, 113, 122	306164	143	308276	101	310704X1	50
303587V	23, 112, 121	306206WP	21, 112, 113, 121	308277	101	310705X1	50
303588V	112, 122	306207WP	21, 112, 113, 122	308290	101	310707X1	50
303655	53	306240	132	308291	101	310709	50
303658	53	306241	132	308292	101	310718	51
303659	53	306280	131	308293	101	310719	51
303662	53	306281	131	308294	101	310720W	51
303678-9	60, 69	306282	131	308295	101	310721W	51
303708-9	70	306283	131	308296	101	310729	47
303808	94, 128, 129	306332	131	308297	101	310736-7	61, 71, 72, 73, 75, 76, 77, 78, 84
303832	211	306333	131	308298	101	310738	61, 71, 72, 73, 75, 76, 77, 78, 84
303928-9	70, 79	306517	138	308299	101	310740	51
303930-1	70	306715	196	308300	101	310741	51
304000W	51	306717	196	308301	101	310844	43, 44, 45, 46, 211
304001W	51	306746X1	40	308302	101	311008	211
304002W	51	306906	259	308303	101	311062	101
304003W	51	306912X1	259	308410	139	311063	101
304064	69	307029X11	42	308432-3W	23	311068	101
304068-9	61, 70	307043	211	308435	101	311069	101
304181	61, 70, 79	307184	100	308456W	211	311079	211
304184P	184	307185	100	308461	143	311084	211
		307188	100	308469	89		
		307189	100	308505	93		

311085.....	211	511216.....	279	513451.....	276	517902.....	158
311089.....	211	511252.....	280	513463.....	27	517903.....	158
311168.....	211	511255.....	280	513502.....	258, 276	517904.....	158
311254.....	101	511300.....	264	513504.....	276	517905.....	158
311255.....	101	511301.....	264	513505.....	276	517906.....	158
311256.....	101	511488.....	204	513508.....	258, 276	517913.....	165
311257.....	101	511650.....	285	513519.....	258, 276	517914.....	165
311260.....	101	511652-4.....	285, 287	513536X1.....	44, 45, 179	517921.....	157
311261.....	101	511652-54.....	284	513607.....	30	517922.....	157
311347.....	211	511660.....	285	513615.....	207	517925.....	157
311351.....	211	511664.....	263, 286	513653.....	203	517925X.....	157
311352.....	211	511674.....	263, 286	513654.....	203	517926.....	157
311401.....	134	511677.....	285	513655.....	203	517926X.....	157
311417.....	40	511678.....	285, 287	513818.....	221	517945.....	176
311446X2.....	145	511708.....	220	513939.....	229	518002.....	165
311446X4.....	145	511728.....	205	514024.....	177	518009.....	265
311446X6.....	145	512212.....	165	514070.....	221	518010.....	265
333060-1W.....	45	512574X1.....	206	514148.....	227, 231, 235	518067.....	58
351370.....	88	512575X1.....	206	514166.....	270	518103.....	159
371245.....	203	512755.....	221	514236.....	163	518104.....	159
371860.....	233	512758.....	221	514449.....	226	518111.....	159
371861.....	233	512761.....	221	514532.....	229	518112.....	159
371862.....	233	512766.....	221	514534.....	229	518113.....	159
371863.....	233	512770.....	255	514536.....	229	518115.....	159
419918.....	202	512863X1.....	205	514661.....	90	518116.....	159
419932.....	262	512927.....	227, 231, 235	515006.....	221	518174.....	176
433812.....	263	512928.....	227, 231, 235	515019.....	221	518227.....	174
439553.....	200	512981.....	227	515021.....	90	518250.....	174
439771.....	202	512984.....	226	515111.....	157	518252.....	176
440448.....	58	512985.....	227	515113.....	57	518254.....	176
440613.....	176	512988.....	228	515202.....	156	518289.....	222
440664.....	162	512989.....	226	515274.....	268	518390.....	275
458410.....	184	512990.....	226, 231, 235	515324.....	208	518407.....	163
458449.....	226	512992.....	228, 232	515378.....	229	518461.....	58
458496.....	233	512993.....	228, 232	515379.....	229	518494.....	90
458502.....	232, 317	512994.....	228, 232	515428.....	186	518495.....	156
458563.....	202	512995.....	228, 232	515506.....	28	518499.....	216
458828.....	207	512996.....	226	515548.....	272, 274	518557.....	174
458873.....	204	512997.....	227	515609.....	28	518619.....	174
458874.....	204	512998.....	227	515645X1.....	217	518626.....	174
473070.....	174	513002.....	227	515645X2.....	44, 45, 217	518627.....	175
473256.....	264	513003.....	227, 231, 235	515645X4.....	217	518671.....	174
473257.....	264	513004.....	227	515656.....	165	518740.....	176
473258.....	264	513005.....	227	515708.....	229, 232, 233	518760.....	174
473259.....	264	513008.....	228	515710.....	161	518824.....	174
510066.....	164	513009.....	228	515832.....	163	518824X1.....	175
510068.....	165	513014.....	229	515835.....	163	518840.....	174
510080.....	160	513017.....	229	516014.....	229	518904.....	275
510131.....	202	513019.....	228	516059.....	265	518948.....	231, 235
510141.....	277, 279, 281	513020.....	229	516196.....	203	518976.....	268
510144.....	279	513021.....	229	516206.....	203	519007.....	28
510145.....	279	513023.....	229	516329.....	264, 286, 287	519008.....	28
510168.....	157	513075.....	226, 230	516330.....	264, 286	519052.....	177
510173.....	221	513079.....	227	516502.....	184	519110.....	275
510193.....	160	513081.....	227	516554.....	229	519111.....	275
510278.....	264	513147.....	251	516565.....	228	519124X1.....	39
510279.....	264	513160.....	212	516566.....	228	519145.....	209
510292.....	279, 280, 281, 283	513183.....	204	516701.....	28	519171.....	278
510426.....	221	513253.....	227	516710.....	28	519175.....	266, 278
510434.....	221	513256.....	226	516712.....	28	519176.....	278
510487.....	275, 276, 277, 279, 281, 282	513257.....	228	516713.....	28	519179.....	33
510516.....	263, 284, 285, 287	513258.....	226	516732.....	226	519180.....	214
510517.....	285, 287	513259.....	227	516742.....	229	519186.....	213
510568.....	265	513260.....	227	516768.....	276	519244.....	272
510693.....	266, 285	513273.....	223, 226	517091.....	272	519245.....	272
510694.....	266, 285	513292.....	229	517127.....	176	519246.....	209
510697.....	285	513301.....	261, 276	517404.....	222	519261.....	226
510716.....	285	513302.....	261, 276	517450.....	266, 278	519303.....	222
510721.....	285	513400.....	227	517504.....	223	519358.....	186
510722.....	284, 285, 287	513421.....	255	517563.....	270	519369.....	270
510725.....	285	513444.....	220	517890.....	186	519383.....	284, 287
510728.....	263, 286	513446.....	277	517894.....	160	519387.....	156
510869.....	277, 279, 281	513447.....	277	517900.....	158	519408.....	161
511126.....	279	513450.....	276	517901.....	158	519409.....	186, 188

519419P	187, 188	520828	158	521497	231	522854	231, 235
519425	231, 235	520834	158	521498	235	522966	208
519432	222	520836	158	521500	232	523000	278
519442	184	520837	158	521501	232	523010	272
519447	222	520883	272, 273	521517	268	523036	272
519450	57	520987	152, 153	521525	156	523056	186
519470	275	520988	152, 153	521567	251	523183	230
519483	271	520996	222	521570	253	523184	161
519493	222	521050	201	521572	250	523203	157
519607	261	521070	275	521594	285	523203X	157
519608	261	521071	272	521604	177	523204	157
519609	261	521092	272	521682	285	523204X	157
519621	231, 235	521093	272	521742	272, 273, 274	523207	272, 273
519627	272, 273	521095	272	521745	231, 233, 235	523208	272, 273
519635	247	521192	272, 273	521749	231, 232	523222	247
519637	249	521214	165	521750	231, 232	523232	92
519691	176	521371	160	521753	232	523297	226
519757	286	521391	250	521754	232	523300	265
519782	27	521392	250	521757	231	523301	265
519783	27	521393	250	521758	231, 232	523349	173
519796	247	521394	250	521761	231, 235	523439	197
519797	247	521395	250	521762	234	523497	265
519798	208	521396	250	521825	284, 285, 287	523538	265
519799	186	521397	250	521861	183	523539	265
519810	195	521398	250	521885	204	523614	249
519816	222	521407	251	521888	204	523657X1	271
519817	212	521423	230	521889	204	523702	264
519822	213	521430	232	521902	161	523703	264
519823	212	521431	232, 233	521979	272	523821	172
519832	222	521433	232	522022	226	523918	255
519844	247	521434	232, 233	522042	271	523966	247
519877	270	521435	232	522042X1	271	524028	250
519917	152	521436	226, 232	522043	271	524029	250
519926	227	521437	226, 232	522043X1	271	524096	264
519957	178	521438	232	522051	278	524142	158
519977	200	521439	232	522052	278	524143	158
519987	200	521440	232	522053	278	524144	158
520085	232	521441	232, 233	522054	278	524145	158
520086	232	521442	232, 233	522067	204	524164	251
520089	27	521443	232, 233	522070	176	524184	278
520101	177	521444	232, 233	522072	160	524230	270
520108	261	521445	232	522095	232	524234	186
520109	261	521448	232, 233	522112	159	524262	204
520110	261, 275, 276, 277	521450	232, 233	522119	159	524296	159
520111	260, 261, 275, 276, 277, 279, 282	521451	232, 233	522159	183	524312	159
520112	261, 275, 276, 277	521452	232, 233	522161	232	524315	159
520113	261, 275, 276, 277	521455	232	522172	232, 233	524316	159
520115	260, 275	521456	232, 233	522177	28	524390	173
520138	158	521457	232, 233	522178	28	524596	163
520145	157	521458	232, 233	522179	28	524605	185
520145X	157	521467	231	522198P	214	524623	217
520146	157	521469	231, 235	522198W	214	524709	285
520188	284, 285	521471	231, 235	522272	222, 223	524781	183
520201	186	521473	231, 232	522293	184	524831	265
520225	161	521474	231, 232, 234	522329	161	524832	265
520234	222	521478	231, 232	522378	230, 234	524833	265
520264	152, 153	521479	231, 234	522379	230, 234	524834	265
520265	152, 153	521480	231, 235	522492	275	524848	222, 223
520345	261, 275, 276, 277	521481	231, 235	522518	262	524849	222, 223
520346	261, 275, 276, 277	521482	231, 235	522523	275	524853	186
520350	212	521483	231, 234	522617	23	524872X1	120, 121, 122, 123, 124, 125, 126, 127, 128
520362	226	521484	231, 234	522632	272	524882	157
520397	247	521485	231, 234	522655	163	524885	91
520411	214	521486	231, 234	522673	262, 265	524950	222
520415	268	521487	231, 235	522695	159	524951	222
520438	261	521488	231, 235	522702	159	524957	185
520439	261	521489	231, 235	522745	161	524964	161
520443	179	521490	231, 235	522777	265	524972x1	90
520454	232	521491	231, 235	522782X1	39	524976	269
520458	163	521492	231, 235	522783X1	39	524977	269
520460	201	521493	231	522785X1	39	525002	260
520810	212	521494	231	522786X1	39	525004	260
520827	158	521495	232	522805	39, 226	525005	260
		521496	231	522850	186		

525007.....	260	526261.....	222	527184.....	162	529211.....	213
525013.....	260	526284.....	196	527191.....	163	529216.....	222
525035.....	270	526288.....	273	527222.....	152	529267.....	161
525047.....	185	526291.....	273	527224.....	160	529300.....	179
525053.....	161	526308.....	152, 153	527240.....	164, 184	529301.....	179
525072.....	90	526310.....	152, 153	527242.....	184	529321.....	152
525099.....	160	526337.....	270	527246.....	184	529327.....	274
525208.....	253	526341.....	195	527253.....	250	529331.....	222
525271.....	220	526350.....	208	527255.....	184	529333.....	222, 223
525315.....	163	526361.....	212	527257.....	57	529341.....	213
525316.....	163	526362.....	212	527260.....	209	529342.....	168
525317.....	163	526364.....	212	527275.....	222, 223	529348.....	158
525319.....	163	526366.....	212	527278.....	222	529369.....	206
525331.....	161	526370.....	27	527284.....	185	529374.....	58
525337.....	231	526387.....	247, 248	527294.....	208	529375.....	238
525339.....	232	526388.....	247, 248	527309.....	161	529391.....	262
525341.....	232	526396.....	201	527328.....	203	529392.....	262
525342.....	232, 233	526411.....	161	527340.....	202	529399.....	284, 285
525343.....	232, 233	526471.....	152, 153	527341.....	203	529412.....	185
525344.....	232, 233	526531.....	255	527350.....	186, 188	529459.....	157
525345.....	232	526543.....	195	527351.....	203	529479.....	226
525350.....	187	526544.....	208	527352.....	203	529489.....	164
525475.....	209	526549.....	195	527394.....	209	529490.....	164
525480.....	248	526551.....	195	527420.....	220	529497.....	186
525548.....	173	526567.....	260	527421.....	220	529527.....	236, 238, 240, 241
525592.....	158	526570.....	261	527423.....	179	529555.....	238
525593.....	158	526571.....	261	527426.....	213	529582.....	218, 238
525594.....	158	526633.....	250	527443.....	175	529585.....	238
525595.....	158	526633X1.....	250	527487.....	206	529587.....	238
525596.....	158	526646.....	20	527517.....	231, 235	529600.....	238
525610.....	180	526646X12.....	20	527523.....	27	529601.....	238
525621.....	247	526675.....	268	527524.....	27	529602.....	238
525625.....	248	526682X1.....	206	527638.....	248	529604.....	238
525627.....	247	526683X1.....	206	527663.....	204	529605.....	238
525630.....	248	526716.....	28	527693.....	162	529606.....	238
525633.....	248	526717.....	28	527694.....	162	529612.....	238
525638.....	248	526718.....	28	527778.....	240, 241	529614.....	238
525639.....	248	526719.....	28	527783.....	219, 239, 240	529615.....	238
525645.....	161	526734.....	28	527801.....	219	529622.....	238
525662.....	272, 273, 274	526735.....	28	527804.....	209	529623.....	238
525668.....	271	526738.....	28	527825.....	217	529628.....	238
525668X1.....	271	526739.....	28	527856.....	164, 184	529629.....	238
525673.....	232, 233	526812.....	206	527858.....	19	529634.....	238
525675.....	232	526815.....	271	527871.....	222	529637.....	238
525810.....	133, 201	526842.....	278	527872.....	222	529640.....	238
525821.....	253	526844.....	271	527874.....	173	529641.....	238
525907.....	272, 273	526844X1.....	271	527890.....	162	529642.....	238, 239
525922.....	161	526845.....	271	527893.....	222	529645.....	238
525927.....	161	526845X1.....	271	527911.....	222	529646.....	238
525931.....	133, 201	526851.....	157	527915.....	222	529647.....	238
525945.....	158	526868.....	207	527955.....	238	529648.....	238
525969.....	175	526875.....	204	527956.....	236	529650.....	239
526092.....	265	526893.....	203	527957.....	241	529657.....	239
526093.....	265	526985.....	203	527958.....	241	529658.....	239
526103.....	273	526995.....	248	527960.....	240, 241	529659.....	239
526114.....	226	527011.....	248	527961.....	239, 240	529660.....	239
526122.....	268	527022.....	273	527962.....	236	529661.....	239
526127.....	268	527024.....	278	527963.....	236	529662.....	239
526133.....	268	527048.....	273	527965.....	236	529663.....	239
526135.....	268	527052.....	273	527966.....	236	529664.....	239
526148.....	265	527057.....	152	527967.....	236	529668.....	239
526162.....	39	527070.....	184	527968.....	236	529677.....	241
526163.....	39	527084.....	157	527972.....	90	529678.....	236, 241
526164.....	39	527088.....	163	527977.....	261	529679.....	241
526184.....	249	527114.....	157	527987.....	269	529680.....	241
526203.....	160	527114X.....	157	529057.....	271	529681.....	241
526204.....	162	527115.....	157	529079.....	237	529686.....	241
526214X1.....	205	527115X.....	157	529082.....	241	529689.....	241
526223.....	157	527121.....	156	529118.....	251	529690.....	241
526224.....	157	527123.....	168	529119.....	251	529697.....	241
526226.....	39	527135.....	178	529129.....	222	529698.....	241
526227.....	39	527138.....	162	529158.....	222	529701.....	240, 241
526230.....	39	527171.....	284, 287	529168.....	268	529704.....	240, 241
526249.....	268	527180.....	162	529169.....	268	529705.....	241

529706.....	241	529910.....	238	530763.....	158	531703.....	207
529707.....	240, 241	529913.....	239	530834.....	184	531705X1.....	206
529710.....	241	529914.....	239	530858.....	162	531713.....	231, 235
529712.....	241	529919.....	241	530867.....	251	531716.....	204
529714.....	239, 240, 241	529967.....	239, 240	530881.....	183	531717W.....	39
529719.....	239, 240, 241	529969.....	237	530902.....	274	531718W.....	39
529722.....	241	529971.....	236	530907.....	274	531720W.....	39
529723.....	241	529972.....	238	530912.....	274	531727.....	213
529724.....	241	529975.....	239	530914.....	274	531746.....	278
529728.....	241	529977.....	238	530916.....	259, 274	531749.....	186
529729.....	239	529979.....	236	530934.....	207	531759.....	203
529730.....	239	529980.....	237	530937.....	202	531760.....	207
529733.....	239	529984.....	236	530975.....	159	531783.....	213
529734.....	239	530009.....	163	530976.....	159	531826.....	183
529736.....	239	530039.....	204	530977.....	159	531842.....	174
529739.....	239, 240	530047.....	28	530978.....	159	531892.....	56
529741.....	239	530048.....	28	530994.....	161	531918.....	173
529749.....	239	530050.....	28	530995.....	161	531933.....	177
529750.....	239	530051.....	28	531013.....	219, 253	531946.....	179
529752.....	240	530062P.....	274	531016.....	278	531968.....	180
529753.....	239, 240	530081.....	156	531036.....	239	531992.....	223
529754.....	239	530083.....	247	531039.....	237	531997.....	223
529756.....	239	530096.....	161	531040.....	236	532009.....	278
529761.....	239	530097.....	188	531046.....	236	532010.....	223
529764.....	241	530127.....	185	531049.....	222, 223	532031.....	223
529767.....	219, 239	530128.....	247	531067.....	232, 317	532032.....	91
529769.....	239	530131.....	183	531075.....	265	532033.....	91
529770.....	239	530143.....	209	531140.....	275	532034.....	223
529774.....	239, 240	530153.....	39	531144.....	273	532035.....	223
529776.....	236	530177.....	212	531147.....	273	532039.....	223
529789.....	236	530178.....	212	531149.....	275	532043W.....	91
529803.....	236	530181.....	247	531179.....	270	532045.....	223
529804.....	236	530186.....	253	531180.....	270	532051.....	223
529810.....	236, 237	530192.....	185	531181.....	270	532053P.....	223
529812.....	237	530202.....	261, 279, 280, 281, 282	531182.....	270	532054.....	223
529813.....	236	530203.....	261	531183.....	270	532063.....	260
529815.....	236	530204.....	261	531184.....	270	532115.....	185
529819.....	237	530213.....	168	531185.....	270	532123P.....	223
529826.....	237	530222.....	163	531186.....	270	532125X.....	157
529827.....	237	530225.....	202	531187.....	270	532128X.....	157
529828.....	236	530226.....	203	531190.....	270	532132.....	209
529830.....	236	530227.....	207	531191.....	270	532133.....	209
529831.....	236	530263.....	165	531192.....	270	532134.....	208
529832.....	236	530266.....	164	531356.....	238	532135.....	204
529833.....	236	530272.....	207	531379.....	179	532161.....	162
529834.....	236	530276.....	152, 153	531385X1.....	206	532174.....	183
529835.....	236	530283.....	186	531392.....	237	532177.....	162
529836.....	236	530297.....	212	531400.....	238	532181.....	270
529837.....	236	530298.....	212	531402.....	238	532200.....	220, 222, 223
529838.....	236	530310.....	177	531409X1.....	236	532258.....	152, 153
529839.....	236	530333.....	263	531409X2.....	236	532273.....	274
529840.....	237	530338.....	251	531415.....	237	532339.....	161
529844.....	236	530355.....	213	531470.....	185	532383.....	185
529848.....	236	530366.....	247	531488.....	222	532385.....	183
529849.....	236	530418.....	163	531489.....	222	532398.....	168
529850.....	236	530421.....	278	531510.....	255	532399.....	168
529851.....	236	530440.....	208	531534.....	188	532400.....	168
529854.....	236	530449.....	285	531543.....	186	532401.....	168
529855.....	236	530451.....	263, 284, 286, 287	531546.....	188	532402.....	168
529856.....	236	530499.....	287	531577.....	224	532403.....	168
529857.....	236	530524.....	213	531578.....	239	532404.....	168
529858.....	236	530525.....	177	531581.....	172	532406.....	268
529859X1.....	238	530555.....	179	531584.....	226, 232	532412.....	183
529859X2.....	238	530560.....	183	531608X1.....	205	532420.....	179
529859X3.....	238	530561.....	223	531635X1.....	206	532425.....	152, 153
529859X4.....	238	530573.....	264, 284, 287	531641.....	207	532430.....	183
529860.....	236	530575.....	213	531647.....	206	532431.....	183
529866.....	236	530576.....	177	531650.....	161	532433.....	188
529867.....	236	530600.....	287	531664.....	159	532454.....	183
529869.....	238	530601.....	183	531665.....	159	532466.....	165
529898.....	238	530616.....	247	531666.....	159	532471.....	165
529899.....	238	530702.....	287	531667.....	159	532473.....	274
529902.....	236	530705.....	287	531670.....	212	532501W.....	201
529909.....	239	530762.....	158	531671.....	212	532502.....	201

532523X1	186	533585	179	535160	251	535703	240
532551	217	533621	179	535164	250	535712	241
532557X1	218	533627	208	535167	251	535732	286
532557X2	218	533631	175	535168	250	535733	286
532557X3	218	533632	175	535189	251	535743	152
532561	260	533756	56	535204	239	535784	160
532565	161	533756X1	56	535207	238	535813	175
532571	179	533761	56	535212	239	535939	162
532579	185	533820	179	535214	239	535951	223
532580	273	533849	31	535216	239	535959	238
532591	28	533890	57	535223	240	535971P	90
532596	28	533892	57	535225	240	535982	152
532597	28	533905	238	535228	209	535996	168
532614X1	226	533918	175	535229	209	536097	152
532615X2	226	533933	223	535234	241	536100P	90
532636	213	533942	203	535263P	185	536124	204
532669	247	533981	186	535274	185	536125	201
532733	176	534004	213	535284	173, 219	536136P	90
532763	231, 235	534019	39	535298	152	536147	223
532764	235	534084	19	535299	196	536150	213
532800	178	534175	222, 223	535321	248	536171	163
532855	92	534195	198	535325	248	536188	158
532857	92	534227	273, 274	535329	223	536195	164
532871	188, 189	534230	179	535330	223	536202	168
532885P	274, 275	534238	187	535331	223	536217	208
532896	226	534266	58	535371	39, 208	536218	209
532902	33	534273	187	535404	212	536219	209
532909	92	534294	57	535435	168	536222	162
532958	209	534296	57	535439	238	536223	168
532968	160	534302	58	535444	241	536253	159
532982	213	534303	157	535445	241	536254	159
532994P	274	534367	212	535446	240	536255	159
533007	86	534383	212	535447	240	536264	163
533010	202	534389	208	535448	241	536292	209
533015P	248	534399	213	535452	241	536306	223
533019	248	534440	156	535467	176	536330	222
533020	247	534451	274	535512	257	536335	220
533022	177	534542	156	535513	248	536346	239
533023	177	534543	219	535514	248	536350W	188
533055	247	534544	239	535515	220	536378	247
533059	260	534584	239, 240	535516	218, 230	536381	174
533064	200	534597	184	535524	251	536410	268
533065	247	534598	152	535527	257	536435	173
533087	183	534616	258	535546	209	536440	179
533092	183	534641	258	535553	56	536444	33
533095	213	534655	258	535554	56	536458	196
533096	177	534666	257	535556	254	536466	174
533103	177	534712	257	535557	254	536502	183
533118	163	534714	184	535558	254	536513	268
533128	156	534720	91	535559	254	536517	269
533161	263, 284, 286, 287	534727	161	535576	238	536539	212
533164	270	534766	179	535577	238	536540	212
533185	161	534801	177	535579	236	536541	212
533188	223	534833	223	535580	239	536542	212
533209	161	534853	58	535583	253	536543	212
533221	161	534872	222, 223	535584	253	536545	213
533230	213	534890	162	535585	253	536546	213
533245	163	534892	162	535586	253	536554	162
533247	185	534946	159	535597	240, 241	536555X	162
533257	185	534949	159	535602	238	536596	179
533278	57	534956	209	535604	241	536617X3	177
533296	152, 153	534957	209	535613	236	536622	251
533302P	186	535033	230, 234	535615	241	536652	249
533329	218	535071X2	198	535617P	164	536701	20
533332	177	535108	247	535626	236	536723	209
533343X1	217	535116	178	535627	238	536725	208
533343X2	217	535117	44, 178	535628	241	536738	31
533343X3	217	535124P	186	535637	238	536739	57
533467	214	535127	177	535644	219	536743	222, 223
533468	214	535128	177	535692	223	536762	58
533475	177	535147	255	535695	174	536774	177
533519	208	535157	251	535697	160	536781	39
533522	208	535158	255	535701	173	536792	161
533578	141	535159	255	535702	173	536795	212

536838.....	28	609386.....	142	652530.....	145	666370.....	286
536868.....	30	609387.....	142	652531.....	145	666465.....	177
536926.....	240	609776.....	145	652534.....	145	666609.....	283
536929.....	28	610607.....	142	652535.....	145	666822.....	260, 280
536930.....	28	612556.....	139	652537.....	132	666858.....	208
536931.....	28	612557.....	139	652538.....	132	667090.....	229
536932.....	28	630363.....	223	652578-9.....	61, 63	667658.....	202
536953.....	173	630651.....	274	652622.....	61	670774.....	265
536985.....	249	630680.....	263	652624.....	61	673015.....	216
537030.....	236	630703.....	266	652720.....	21	673626.....	280
537033.....	238	630724.....	280, 282, 283	652734.....	54	673627.....	280
537040.....	238	630728.....	266	652735.....	54	673887X.....	267
537043.....	238	630836.....	280, 283	652750.....	172	673969.....	183
537045.....	238	630845.....	280	652780.....	192	673976.....	216
537047.....	239	631469.....	221	652780X.....	192	674037.....	216
537050.....	239	631884.....	280	652796.....	146	674041.....	173
537053.....	239	631893.....	221	652809P.....	88	674069.....	177
537054.....	241	631956.....	266	652816-7.....	29	674156.....	265
537055.....	240	631959.....	266	652933.....	41	674292.....	247
537056.....	240	633100.....	164	652934.....	41	674450.....	266
537059.....	240	634304.....	266	653022.....	145	674533X1.....	271, 280
537063.....	240	635267.....	203	653096.....	132	674534.....	271, 280
537066.....	237	636343.....	266	653230.....	55	674535.....	271, 280, 283
537085.....	212	636346.....	266	653277.....	211	674595.....	175
537086.....	212	636805.....	222	653414.....	40	674596.....	175
537108.....	223	636965.....	271	653415X61.....	40	674854.....	177
537187.....	179	637407.....	176	653421.....	55	674859.....	230
537219.....	156	639182.....	266	653422.....	55	674866.....	231
537220.....	156	639512.....	223	653462.....	59, 63	674868.....	231, 234
537221.....	156	640080.....	266	653495.....	145	674869.....	218, 231, 232, 233, 235
537239.....	249	640666.....	263	653702.....	55	674872.....	231
537240.....	240	641311W.....	194	653703.....	55	674873.....	231
537248.....	240	641311X2.....	194	653745.....	133	674874.....	231
537251.....	240	642522.....	255	653745X.....	133	674883.....	231
537253.....	239	643158.....	254	653832-3.....	145	674884.....	231, 234
537255.....	240	644751.....	255	661346.....	264	674885.....	231, 235
537262.....	240	648258.....	91	661403.....	271	674887.....	235
537266.....	240	648626.....	145	661556.....	165	674888.....	235
537288.....	223, 247	648667X1.....	38, 44	661574.....	20	674889.....	231, 235
537354.....	173	648692.....	132	661926.....	203	674890.....	231, 235
537355.....	179	648693.....	132	662777.....	266	674993.....	152, 153
537356.....	179	648702.....	289	663286.....	184	674994.....	152, 153
537396.....	238	648702X2.....	289	663647.....	165	675149.....	212
537410.....	213	648703.....	289	664076*.....	220	675269.....	44, 45, 221, 222, 223, 247
537423.....	212	648703X3.....	289	664443.....	266, 278	675417.....	57
537461.....	270	648720.....	145	664444.....	266	675466.....	250
537522.....	157	648723.....	145	664736.....	266	675736.....	183
537528.....	174	648736.....	59, 63	664824.....	261, 280, 283	676180X3.....	27
537529.....	174	648761.....	198	664967.....	173	676413.....	280
537669X1.....	226	648805.....	145	665015.....	260, 280	676553.....	280, 282
537687.....	233	648858.....	40, 44	665106.....	27	676554.....	280, 282
537697.....	174	648942.....	289	665121.....	269	676587.....	271, 280, 282
537699.....	238	648943.....	289	665190.....	204	676657.....	30
537702.....	238	649030.....	192	665291.....	280	676659.....	28
537719.....	247	649092.....	259	665292.....	280	676661.....	28
537790.....	240	649117.....	63, 88	665295.....	280	676662.....	28
537791.....	240	651844.....	289	665296.....	280	676683.....	265
537793.....	240	651845.....	289	665309.....	280	676692.....	279
537794.....	240	651898.....	145	665604.....	264	676696.....	279
537796.....	240	652078.....	55	665620.....	264	676714X1.....	205
537797.....	240	652100.....	59, 63	665624.....	212	676751.....	279
537799.....	240	652133-4WP.....	21	666007.....	261, 280, 283	676841.....	283
537813.....	88	652143.....	81	666009.....	280	676849X.....	267
537814.....	239	652203.....	43, 44, 45	666010.....	280, 283	677056X.....	267
537829.....	206	652204.....	44, 45, 47	666013.....	280	677057X.....	267
537833.....	186, 188	652220.....	32	666014.....	280	677058X.....	267
537906.....	263, 286	652242.....	43, 44, 45	666131.....	251	677063.....	185
537933.....	249	652384.....	145	666193.....	261, 279, 280, 281, 282	677156.....	265
537955.....	219	652385.....	145	666194.....	261, 279, 280, 281, 282	677157.....	265
537956.....	239	652404.....	131	666233.....	286	677162.....	282
564371.....	159	652405.....	131	666252.....	260, 280	677163.....	282
607980.....	145	652476.....	145	666277.....	280	677167.....	282
607981.....	145	652502.....	88	666292.....	261, 280, 282	677223.....	269
609384.....	142	652522.....	132	666293.....	261, 280, 282	677266.....	58

677272	269	679937	265	683875	162	800002	60
677274X	267	680000X1	212	683876	212	800004	26, 44, 45, 46
677282	152	680008	30	683974	173	800008	27
677296	266	680018	173	683979	168, 216	800009	27
677297	266	680154	28	684020	179	800013	33, 46
677308	264	680164	28	684030	212	800018	311
677309	264	680204	161	684041	177	800023	60, 63, 64, 65, 66, 67, 68, 69, 70, 71, 72, 73, 74, 75, 76, 77, 78, 79, 80, 81, 82, 83, 84
677310	264	680209	274	684053X	267	800024	213
677311	264	680210	273, 274	684056X	267	800025	26, 44, 45, 46
677314	264	680211	272	684059	176	800026	26
677318	264	680212	272, 273	684115	27	800027	26
677442	249	680279	176	684116	27	800028	26
677526X	267	680280	45, 178	684121	177	800029	26
677528X	267	680291	164, 165	684131	58	800030	26, 44, 45, 46
677545X1	286	680292	164, 165	684134	279, 281	800031	33, 44
677545X3	286	680651	279	684135	279, 281, 282	800032	60, 63
677545X4	286	680697	162	684144	279, 281, 282	800033	60
677545X7	286	680717	186	684145	279, 281, 282	800034	60
677545X12	286	680730	57	684146	279, 281, 282	800035	23
677604	279, 280	680748	176	684147	279	800036	32
677605	279, 280	680772	175	684150	281, 283	800039	160
677614	249	680847	165	684151	281, 283	800044	33
677658	263	680896	207	684159	281, 283	800050	33
677711X2	27	680908	208	684160	281, 283	800050A	33
677711X3	27	680940	220	684161	281, 283	800050B	33
677721X1	286	680942	216	684162	281, 283	800051X1	314
677916P	183	681066	219	684163	261, 281, 283	800051X2	314
678010	220	681068	253	684164	261, 281, 283	800051X3	314
678036	265	681093	254	684332X	267	800052	292
678037	265	681107	173	684435	165	800053	308
678131	174	681192X	267	684492	271, 281, 282	800067	312
678138	263	681195X	267	684493	271, 281, 283	800068	312
678164	216	681254	186	684548	208	800069	312
678165	216	681425	172	684584	196	800070	312
678171	271, 279, 280, 281, 282	681426	172	684606	253	800071	312
678225	20	681470	186	684606-7	253	800072	312
678478	247	681512	260, 283	684656	186	800073	312
678536	175	681682	223	684771	255	800074	312
678540	175	681729	39, 208	684785	248	800075	300
678541	175	681756	216	684836	213	800076	213
678592	283	681768	180	684881	218	800077	213
678593	283	681832	255	684973	287	800078	31, 300
678594	283	681903X	267	685029	269	800079	216
678604	220	681904X	267	685044	175	800080	216
678630	265	681905X	267	700001	260	800082	20
678631	265	682024	177	700002	260	800083	311
678632	265	682027	265	750072	307	800084	311
678668	279, 281	682133	27	750077	47	800085	311
678669	281	682136	28	770011	67	800086	311
678670	279	682148	165	770012	76, 77	800087	311
678672	279	682630	184	770013X9	59, 67	800088	311
678730	268	682630R	184	770016	64, 67	800089	311
678734X	267	682695	162	770031	213	800090	311
678842X	267	682708	163	770045	32	800093	36
678846X	267	682738P	91	770046	32	800099	36
678884X1	286	682756	33	770047	33	800100	36
678953	218	682758	33	770048	33	800101	36
679048	254	682818	216	770078	91	800102	36
679131X	267	682824	220	770093	27	800110	20
679255	273, 274	682891	212	770147	64	800131	312
679257	259, 273, 274	682919	185	770148	64	800133	312
679258	260, 279	683043	251	770149	67	800135	312
679274	260, 281, 282	683098	28	770150	70	800136	312
679276	281, 283	683099	28	770151	64	800140	49
679290	216	683136X1	212	770152	64, 67	800157	271
679292	266	683136X2	212	770153	70, 79	800179	255
679293	266	683328	263	770206	268	800180	255
679393	186	683448	253	770206X1	268	800182	255
679614	279	683448-9	253	770210	268	800183	182
679690	249	683450	253	770210X	268	800185X2	92
679754	213	683450-1	253	770530	88	800185X3	92
679852X	267	683452	254	790123	38	800185X4	92
679859X	267	683453	254	800000	60		
679936	173	683843	220	800001	60		

800188X2.....	34	800304.....	300	800414.....	11	800507X14.....	62, 80, 81, 83
800188X3.....	34	800307.....	10, 178	800415.....	11	800507X15.....	62, 82
800188X4.....	34	800309.....	308	800416.....	11	800507X16.....	62, 80, 82
800188X5.....	34	800315.....	159	800417.....	11, 14	800507X17.....	62, 64, 67
800192.....	30	800317.....	255	800418.....	11, 14	800507X18.....	62, 65
800193.....	30	800318.....	159	800419.....	11, 14	800507X19.....	69, 71
800197R.....	35	800319.....	159	800420.....	11, 14	800513.....	309
800200.....	37	800320.....	159	800421.....	11, 15	800514.....	187
800201.....	88	800321.....	159	800422.....	11, 15	800515.....	187
800202.....	88	800322.....	158	800423.....	11, 15, 16	800516.....	187
800203.....	18, 118, 119	800323.....	158	800424.....	11, 16	800517.....	187, 188
800204.....	174	800324.....	158	800425.....	11	800517X1.....	187
800206.....	207	800325.....	158	800426.....	11, 16	800523.....	43
800209.....	88	800329.....	159	800427.....	11	800524.....	60, 187
800209X1.....	35	800330.....	159	800429.....	12, 14	800525.....	60, 187
800209X1R.....	35	800331.....	271	800430.....	12, 14, 15	800527.....	27
800209X2.....	35	800332.....	315	800431.....	12, 15, 16	800528.....	28
800209X2R.....	35	800333.....	315	800432.....	12, 16	800529.....	27
800209X3.....	35	800334.....	315	800433.....	12	800531.....	38
800209X3R.....	35	800335.....	315	800434.....	12, 14	800534.....	162
800209X4.....	35	800336.....	315	800435.....	12	800535.....	162
800209X4R.....	35	800340.....	254	800436.....	12, 15, 16	800536.....	260
800209X5.....	35	800340-1.....	254	800437.....	12, 16	800537.....	262
800209X5R.....	35	800342.....	254	800439.....	12	800538.....	262
800209X6.....	35	800343.....	255	800440.....	12, 14	800539.....	262
800209X6R.....	35	800345.....	211	800441.....	12	800540.....	262
800218-9.....	38	800355.....	258	800442.....	12	800542R.....	84
800220-1.....	38	800356.....	184	800443.....	13, 14	800543.....	165
800223.....	159	800360.....	9	800447.....	13	800547.....	13, 15
800224.....	313	800362.....	74, 82, 87	800448.....	13, 14	800548.....	13, 16
800225.....	313	800363R.....	38	800449.....	13, 15	800551.....	163
800226.....	313	800364.....	18	800450.....	13, 15	800552.....	163
800227.....	313	800364X.....	18	800451.....	13, 16	800553.....	163
800236.....	164	800365.....	18	800452.....	13, 16	800554.....	163
800237.....	34	800365X.....	18	800453.....	13, 16	800556.....	32
800241.....	178	800367.....	219	800454.....	13, 16	800566.....	163
800243.....	13, 16	800368.....	219	800455.....	13, 16	800567.....	163
800244.....	12, 16	800369.....	219	800456.....	13	800568.....	163
800245.....	11, 16	800370.....	219	800457.....	13, 16	800569.....	163
800247.....	17, 301	800371.....	219, 224	800458.....	13, 16	800570.....	163
800248.....	12	800372.....	219	800459.....	13, 17	800571.....	163
800249.....	173	800374.....	220	800460.....	13, 16, 17	800572.....	163
800250.....	173	800375.....	220	800461.....	13	800573.....	163
800252.....	60, 70, 72, 73, 74, 76, 77, 78, 79, 80, 81, 82, 83	800376.....	220	800470.....	292	800581.....	56
800253.....	60, 64, 65, 66, 67, 68, 72	800377.....	220	800476R.....	38	800582.....	32
800254.....	168	800378.....	220, 224	800478.....	208	800583.....	32
800255.....	168	800380.....	218, 230	800480.....	182	800584R.....	35
800256.....	168	800382.....	167	800484R.....	33	800585.....	23, 113, 114, 117, 118, 128
800257.....	168	800383.....	166	800484T.....	33	800587X25.....	141
800258.....	168	800384.....	167	800486.....	315	800591.....	313
800259.....	168	800385.....	166	800490R.....	249	800592.....	313
800260.....	88	800386*.....	167	800503.....	209	800593.....	313
800261.....	88	800387.....	167	800504.....	62, 65, 66, 67, 68, 69, 71, 72, 73, 75, 76, 77, 78, 84	800594.....	313
800262.....	88	800388.....	163, 164, 165	800504X8.....	62, 65, 66, 68, 72, 73, 75, 76, 77, 78	800602.....	314
800263.....	19	800389.....	163	800505.....	62, 80, 81, 83	800603.....	314
800264R.....	35, 44, 45	800390.....	163	800505X8.....	62, 81, 83	800604.....	314
800265R.....	35, 46	800391*.....	163	800506.....	62, 63	800606.....	290
800266.....	164	800393.....	156	800507.....	62	800607.....	290
800266X1.....	164	800394.....	156	800507X1.....	62, 63	800608.....	290
800277.....	255	800396.....	174	800507X2.....	62, 63	800609.....	290
800278.....	255	800397.....	164	800507X3.....	62, 66, 67	800610.....	290
800279.....	152	800397X1.....	164	800507X4.....	62, 66	800611.....	290
800280.....	159	800398.....	165	800507X5.....	62, 65	800612.....	290
800282.....	311	800400BX11.....	68, 69, 71, 72, 73, 75, 76, 77, 78, 84	800507X6.....	62, 68, 72, 73, 76, 78	800613.....	290
800284.....	313	800400X3.....	64, 67, 70	800507X7.....	62, 68, 71, 72, 73, 75, 77, 78	800614.....	290
800287.....	198	800400X5.....	70, 74, 76, 79	800507X8.....	62, 69	800615.....	290
800288.....	198	800400X11.....	65, 66, 67, 69, 77	800507X9.....	62, 70	800617W.....	23, 114, 125, 126
800289.....	305	800401X4.....	64, 65, 66, 67, 68, 69, 70, 71, 72, 73, 74, 75, 76, 77, 78, 79, 80, 81, 82, 83, 84	800507X10.....	62, 70, 74, 76, 79	800618.....	30
800290.....	305	800403X11.....	60, 62, 63	800507X11.....	62, 75, 84	800619.....	30
800291.....	305	800404X3.....	63	800507X12.....	62, 79	800688R.....	84
800292.....	301	800405.....	80, 81, 82, 83	800507X13.....	62, 81, 83	800688X1.....	84
800295.....	312	800413.....	11			800689.....	168
800298.....	89					800693.....	265
						800694.....	265

800697.....	265	800827R.....	38	800954.....	201	801011X1.....	81
800698.....	265	800827RX1.....	38	800955.....	187	801012R.....	83
800699.....	183	800828.....	42	800957.....	159	801012X1.....	83
800700.....	185	800829.....	42	800958.....	159	801013R.....	80
800709R.....	37	800832R.....	38, 44, 45, 46	800959.....	159	801013X1.....	80
800710.....	262	800834R.....	29	800960.....	159	801016R.....	170
800715.....	289	800835R.....	29, 45	800963.....	16, 294	801017R.....	170
800716.....	289	800836R.....	29, 46	800964.....	16, 294	801018R.....	170
800717.....	289	800837R.....	29, 44	800965.....	16, 294	801019R.....	170
800718.....	289	800838.....	39	800966.....	16, 294	801020R.....	170
800719.....	289	800839.....	39	800967.....	16, 294	801021R.....	169
800720.....	289	800851.....	61, 68, 69, 71, 72, 73, 75, 76, 77, 78, 83, 84	800968.....	16, 17, 294	801021X2R.....	169
800721.....	289	800851X1.....	61, 80, 81	800969.....	294	801021X3.....	169
800722.....	289	800851X2.....	61, 83	800970.....	312	801021X3R.....	169
800723.....	289	800851X3.....	61, 77	800971.....	32	801022R.....	169
800724.....	289	800851X4.....	61, 80, 81	800974.....	309	801023R.....	169
800725.....	289	800851X5.....	61, 83	800975.....	163	801024R.....	169
800726.....	289	800852.....	61, 70, 74, 76, 79, 80, 82	800976R.....	212	801025R.....	169
800727.....	289	800853.....	38	800978.....	310	801026R.....	169
800728.....	289	800854.....	201	800979.....	310	801027R.....	169
800729.....	289	800855.....	201	800980.....	310	801028R.....	165
800730.....	289	800856.....	201	800982X1.....	63	801029R.....	165
800731.....	289	800857.....	201	800983R.....	63	801030R.....	202
800732.....	289	800858.....	201	800983X1.....	63	801031R.....	202
800733.....	289	800867.....	201	800984R.....	84	801032R.....	202
800734.....	289	800868.....	290	800985.....	310	801033R.....	202
800743.....	160	800869.....	290	800985R.....	64	801034R.....	202
800745.....	160	800870.....	290	800985X1.....	64	801035R.....	252
800751.....	310	800871.....	290	800986R.....	67	801036R.....	252
800751X6.....	310	800872.....	291	800986RX1.....	67	801037R.....	252
800760.....	33	800873.....	291	800987R.....	65	801039R.....	254
800762.....	310	800874.....	291	800987X.....	65	801040R.....	254
800762X6.....	310	800875.....	291	800988R.....	66	801041R.....	263
800768.....	18	800876.....	291	800989R.....	66, 67, 68	801042R.....	266
800769.....	18	800877.....	291	800989X1.....	66	801043R.....	266
800770.....	18	800878.....	291	800990R.....	68	801044R.....	258
800771.....	18	800879.....	296	800990X1.....	68	801045R.....	258
800772.....	18	800893.....	310	800991R.....	68	801046R.....	258
800773.....	18	800896.....	310	800991X1.....	68	801047R.....	258
800776.....	290	800897.....	310	800992R.....	70	801048R.....	258
800777.....	159	800898.....	310	800992X1.....	70	801049R.....	258
800782.....	186	800899.....	310	800993R.....	72	801050R.....	269
800783.....	186	800900.....	310	800993X1.....	72	801052.....	18
800784.....	158	800901.....	310	800994R.....	72	801053.....	310
800785.....	158	800902.....	310	800994X1.....	72	801063R.....	254
800786.....	262	800903.....	310	800995R.....	69, 70	801064R.....	254
800791.....	164	800907.....	152	800996R.....	73, 76	801067.....	296
800794.....	251	800908.....	253	800996X1.....	73	801069R.....	309
800796.....	61, 65, 66, 67	800913.....	8	800997R.....	73	801076R.....	170
800797.....	61, 63, 69	800917.....	216	800997X1.....	73	801077R.....	258
800798.....	61, 62, 63	800918.....	216	800998X1.....	75	801078R.....	258
800799.....	64, 67	800919.....	305	800999R.....	75	801079.....	24
800800.....	59, 66	800920.....	311	800999X1.....	75	801080.....	24
800804.....	213	800922.....	315	801000R.....	75	801081R.....	170
800806.....	61, 65, 66, 67	800923.....	315	801001R.....	74, 75	801082.....	298
800807.....	61, 69	800924.....	315	801001X1.....	74	801083.....	91
800810.....	168	800925.....	315	801002R.....	74	801084.....	294
800811.....	168	800927.....	214	801003R.....	76	801085.....	294
800812.....	168	800933X1.....	313	801003X1.....	76	801086.....	300
800813.....	26, 45	800933X2.....	313	801004R.....	74, 75	801087.....	300
800814.....	26	800933X3.....	313	801004X1.....	74, 75	801088.....	300
800815.....	26	800933X4.....	313	801005R.....	80	801089.....	300
800816.....	26	800934.....	309	801005X1.....	80	801090.....	301
800817.....	26	800935.....	11	801006R.....	82, 83	801091R.....	170
800818.....	26	800936.....	292	801006X1.....	82	801092.....	164
800819.....	26, 45	800942.....	265	801007R.....	82	801093.....	164
800820R.....	35	800944.....	156	801007X1.....	82	801095.....	208
800821R.....	35	800945.....	172	801008R.....	79, 83	801098.....	298
800822R.....	35, 44	800946.....	172	801008X1.....	79	801100.....	60, 79, 80
800823.....	45	800948.....	172	801009R.....	81	801101.....	305
800823R.....	35, 44	800949.....	172	801009X1.....	81	801103.....	308
800824R.....	38, 44	800950.....	292	801010R.....	83	801106.....	305
800825R.....	38, 44	800952.....	32	801010X1.....	83	801107.....	156
800826R.....	38, 45	800953.....	290	801011R.....	81	801108.....	310

801109.....	207	801193.....	16	801305.....	316	801416.....	296
801110.....	207	801194.....	16	801306.....	316	801417.....	296
801111.....	300	801195.....	16	801307.....	316	801418.....	296
801114.....	301	801196.....	16	801308.....	316	801419.....	296
801117.....	9	801198.....	17	801309.....	316	801420.....	296
801118.....	10	801199.....	16	801310.....	316	801421.....	296
801119.....	298	801204R.....	38, 44, 45, 46	801312.....	317	801422.....	299
801120.....	183	801206R.....	204	801313.....	317	801423.....	296
801121R.....	84	801207R.....	206	801314.....	317	801426.....	317
801121X1.....	84	801208R.....	207	801315.....	317	801428.....	184
801123.....	249	801209.....	164	801316.....	317	801432R.....	69
801124.....	18	801213.....	156	801317.....	317	801433R.....	71
801125.....	18	801214.....	32	801318.....	317	801433X1.....	71
801126.....	18	801215R.....	35	801319.....	317	801434R.....	71
801127.....	18	801216.....	218	801320.....	317	801434X1.....	71
801128.....	18	801230.....	298	801321.....	317	801435.....	117
801128B.....	18	801231.....	13	801322.....	317	801436.....	118
801129.....	18	801233.....	164	801323.....	317	801445R.....	70
801129B.....	18	801236.....	37	801324.....	317	801446.....	262
801131R.....	252	801240.....	145	801325.....	317	801447.....	262
801132R.....	252	801241.....	39	801340.....	300	801448.....	262
801133R.....	252	801242R.....	65	801341.....	300	801449R.....	75
801134R.....	252	801242X1.....	65	801344.....	59	801449X1.....	75
801135.....	113	801243R.....	67	801347.....	160	801452.....	307
801135R.....	252	801243X1.....	67	801348.....	20	801453.....	47
801136.....	113	801244X1.....	66	801349.....	198	801458.....	162
801136R.....	252	801246.....	164	801350.....	198	801459.....	162
801137.....	113	801247.....	60, 62	801351.....	198	801460.....	162
801137R.....	252	801249.....	11	801352.....	257	801461.....	162
801138.....	113	801250.....	11	801353.....	182	801464.....	160
801138R.....	252	801251.....	11	801354.....	163	801465.....	308
801139.....	113	801252.....	11	801355.....	163	801468R.....	76, 77, 78, 79, 81, 83
801139X1.....	114	801253.....	12	801356.....	163	801469X1.....	77, 78
801140.....	114	801256.....	145	801358.....	204	801470R.....	79, 81
801141.....	114	801257.....	64, 67	801359.....	60, 62	801470X1.....	79, 81
801142.....	114	801258.....	37	801360.....	60	801471R.....	78, 79, 81, 83
801143.....	114	801259R.....	258	801361.....	60, 62	801471X1.....	78
801144.....	114	801263.....	131	801362.....	262	801472X1.....	78, 79, 81
801145.....	115	801265.....	64	801363X1.....	308	801483.....	308
801146.....	115	801269.....	166, 167	801363X2.....	308	801483x1.....	308
801147.....	115	801270.....	166, 167	801363X5.....	308	801483x2.....	308
801148.....	115	801271.....	166	801365.....	159	801486.....	294
801149.....	115	801272.....	166, 167	801366.....	145	801487.....	294
801150.....	115	801273.....	167	801367.....	26	801488.....	294
801151.....	115	801274.....	167	801368.....	306	801489.....	294
801152.....	115	801275*.....	167	801371.....	185	801490.....	294
801153.....	116	801277.....	250	801372.....	185	801491.....	294
801154.....	116	801278.....	250	801379.....	300	801492.....	294
801155.....	116	801279.....	209	801380.....	300	801493.....	295
801156.....	116	801280.....	11	801381.....	300	801494.....	294
801157.....	116	801281.....	11	801384.....	314	801495.....	295
801158.....	116	801282.....	12	801385.....	314	801496.....	295
801159.....	116	801283.....	12	801386.....	295	801498.....	315
801160R.....	117	801284.....	12	801387.....	298	801507.....	295
801161R.....	117	801285.....	317	801388.....	145	801508.....	295
801162R.....	117	801286.....	317	801389.....	301	801509.....	295
801163R.....	117	801287.....	317	801390R.....	269	801510.....	295
801164R.....	118	801288.....	317	801391.....	13	801511.....	295
801165R.....	119	801289.....	317	801392.....	13	801512.....	295
801166R.....	119	801290.....	317	801393.....	13, 14	801513.....	295
801167R.....	119	801291.....	317	801394.....	300	801514.....	294
801168R.....	165	801292.....	317	801395.....	298	801515.....	294
801169R.....	165	801293.....	317	801396.....	298	801516.....	295
801171.....	160	801294.....	317	801400.....	298	801517.....	295
801172.....	160	801295.....	317	801403.....	298	801518.....	295
801181.....	14	801296.....	317	801404.....	298	801519.....	295
801182.....	14	801297.....	317	801405.....	291	801520.....	295
801183.....	14	801298.....	317	801406.....	291	801522.....	315
801184.....	14	801299.....	316	801407.....	291	801523.....	295
801185.....	14	801300.....	316	801408.....	291	801524.....	21
801187.....	15	801301.....	316	801412.....	63	801527.....	118
801188R.....	15	801302.....	316	801413R.....	77	801528.....	26
801191.....	16	801303.....	316	801413X1.....	77	801529.....	26
801192.....	16	801304.....	316	801415.....	301	801530.....	26

801531.....	26	801657.....	300	801802.....	313	801889.....	97
801532.....	26	801658.....	300	801806.....	291	801890.....	97
801533.....	26	801659.....	299	801807.....	291	801891.....	97
801534.....	26	801661.....	299	801808.....	291	801892.....	97
801535.....	26, 44	801662.....	299	801809.....	291	801893.....	97
801536.....	26	801663.....	299	801810.....	38	801894.....	97
801537.....	26	801664.....	300	801812.....	64	801895.....	97
801538.....	26	801665.....	300	801812X1.....	64	801896.....	98
801539.....	26	801666.....	38	801813.....	20	801897.....	98
801540.....	26	801667.....	38	801814.....	112	801898.....	98
801541.....	26, 44	801673.....	38	801815.....	112	801899.....	98
801542.....	133, 201	801674R.....	38	801816.....	187	801900.....	98
801543.....	133, 201	801675V.....	21, 113, 123	801818.....	248	801901.....	98
801544.....	292	801676.....	292	801819.....	248	801902.....	98
801545.....	38	801679.....	295	801820.....	262	801903.....	98
801549.....	38	801680.....	295	801821.....	262	801904.....	98
801550.....	162	801681.....	299	801822.....	262	801905.....	99
801551.....	259	801682.....	309	801823.....	278	801906.....	99
801553.....	159	801683X1.....	308	801824.....	278	801907.....	99
801554.....	159	801683x3.....	308	801825.....	278	801908.....	99
801556X1.....	308	801686.....	291	801826.....	255	801909.....	99
801556X3.....	308	801687.....	291	801827.....	62	801910.....	99
801558R.....	253	801688.....	291	801828R.....	15	801911.....	99
801559R.....	253	801689.....	291	801829.....	310	801912.....	99
801560R.....	253	801692.....	56	801830.....	168	801913.....	99
801561R.....	253	801693.....	56	801831.....	264	801914.....	100
801566.....	43	801695.....	61	801835.....	91	801915.....	100
801566X1.....	43	801696.....	291	801836.....	55	801916.....	100
801567.....	44	801697.....	61, 70, 79	801837.....	195	801917.....	100
801569.....	44	801699.....	13, 15	801839.....	179	801920.....	92
801570.....	45	801700.....	13, 15	801844.....	177	801922.....	168
801571.....	44	801702X1.....	308	801845.....	177	801923.....	128
801572.....	45	801702X2.....	308	801846.....	292	801924.....	172
801573.....	46	801702X3.....	308	801847.....	160	801925.....	32
801577.....	153	801703.....	308	801847X10.....	160	801926.....	168
801578.....	153	801704.....	250	801848V.....	21	801927.....	153
801579.....	153	801705.....	11	801850.....	56	801928.....	29
801580.....	153	801709.....	117	801851.....	249	801928B.....	29
801581.....	153	801710.....	118	801852.....	173	801929.....	29
801582.....	153	801711.....	118	801853.....	18	801930.....	142, 182
801583.....	153	801714.....	18	801854.....	18	801931.....	209
801584.....	153	801714R.....	18	801855.....	299	801932.....	209
801585.....	153	801716.....	20	801856.....	299	801933.....	209
801586.....	153	801717.....	20	801857.....	116, 120, 121, 197	801934.....	42
801589.....	153	801718.....	20	801858.....	182	801935.....	42
801590.....	153	801719.....	20	801860.....	93	801948.....	121
801591.....	153	801720.....	20	801861.....	93	801949.....	121
801592.....	153	801721.....	20	801862.....	94	801950.....	122
801596.....	153	801723.....	25	801863.....	94	801951.....	122
801598.....	153	801725.....	29	801864.....	94	801952.....	122
801599.....	153	801737.....	20	801865.....	94	801953.....	123
801610.....	120	801768.....	298	801866.....	94	801954.....	123
801611.....	120	801769.....	314	801867.....	94	801956.....	124
801612.....	121	801770.....	314	801868.....	94	801957.....	124
801614.....	128, 199	801771.....	314	801869.....	95	801959.....	124
801615.....	129, 199	801772.....	314	801870.....	95	801960.....	124
801616.....	129, 199	801773.....	313	801871.....	95	801961.....	124
801617.....	129, 199	801774.....	313	801872.....	95	801962.....	125
801618.....	129, 199	801775.....	313	801873.....	95	801963.....	125
801619.....	130, 199	801776.....	313	801874.....	95	801964.....	126
801620.....	130, 199	801777.....	10	801875.....	95	801965.....	126
801621.....	130, 199	801778.....	10	801876.....	95	801966.....	127
801622.....	130, 199	801779.....	10	801877.....	95	801967.....	127
801623.....	130, 199	801781.....	10	801878.....	96	801968.....	10
801624.....	312	801782.....	10	801879.....	96	801971.....	62
801627.....	268	801783.....	10	801880.....	96	801972.....	187
801628.....	292	801784.....	298	801881.....	96	801973.....	26
801630.....	310	801786.....	56	801882.....	96	801974.....	26
801641.....	310	801787.....	56	801883.....	96	801975.....	26
801651.....	259	801788.....	208	801884.....	96	801976.....	26, 45
801652.....	10, 178	801789.....	29	801885.....	96	801977.....	26
801653.....	193	801799.....	308	801886.....	96	801978.....	26, 45
801655.....	8	801800.....	308	801887.....	97	801979.....	26
801656.....	300	801801.....	313	801888.....	97	801980.....	26

801981.....	26	802116X7.....	311	802230.....	299	802316.....	8
801982.....	26, 44	802116X8.....	311	802231.....	299	802318.....	26
801983.....	26	802123.....	307	802232.....	299	802319.....	301
801984.....	26, 44	802124.....	307	802233.....	30	802320.....	301
801985.....	128	802133.....	293	802234.....	198	802323.....	307
801986.....	129	802140x1.....	310	802235.....	10	802324.....	307
801987.....	129	802140x2.....	310	802236.....	10	802325.....	307
801988.....	129	802140x3.....	310	802237.....	13, 15	802327.....	306
801989.....	129	802141.....	310	802239.....	15	802328.....	306
801990.....	129	802148.....	302	802240R.....	35	802332.....	301
801991.....	130	802149.....	302	802241.....	34	802333.....	293
801992.....	130	802150.....	302	802242.....	34	802334.....	293
801993.....	130	802151.....	302	802243.....	34	802335.....	293
801994.....	130	802152.....	302	802244.....	34	802336.....	293
801995.....	130	802153.....	302	802245.....	34	802337.....	293
802003.....	312	802154.....	302	802246.....	34	802338.....	309
802004.....	312	802155.....	302	802247.....	30	802339X1.....	313
802005.....	312	802156.....	302	802249.....	30	802339X2.....	313
802006.....	312	802157.....	302	802250.....	30	802339X3.....	313
802008.....	289	802158.....	302	802251.....	301	802339X4.....	313
802009.....	289	802159.....	302	802252.....	20	802348X1.....	313
802010.....	306	802160.....	302	802255.....	163	802348X2.....	313
802024.....	296	802161.....	302	802256.....	163	802348X3.....	313
802026.....	296	802162.....	302	802257.....	311	802348X4.....	313
802029.....	301	802165.....	310	802258.....	311	802351.....	28
802038.....	310	802167.....	296	802259.....	297	802352X1.....	313
802038X1.....	310	802168.....	296	802259X1.....	297	802352X2.....	313
802038X2.....	310	802168X1.....	296	802260.....	297	802352X3.....	313
802040.....	87	802169.....	297	802261.....	311	802352X4.....	313
802041.....	173	802170.....	297	802262.....	311	802353.....	293
802042.....	301	802171.....	297	802265.....	305	802355.....	30
802043.....	16, 301	802172.....	302	802266.....	305	802356.....	30
802044.....	16, 17, 301	802173.....	302	802267.....	305	802357.....	30
802045.....	296	802174.....	302	802268.....	305	802358.....	30
802047.....	296	802177.....	14	802269.....	302	802369.....	303
802048.....	296	802178.....	13, 14	802270.....	302	802370.....	303
802050.....	307	802179.....	13, 15	802271.....	302	802371.....	303
802059.....	31	802180.....	13, 15	802272.....	14	802372.....	303
802060.....	31	802181.....	13, 15	802273.....	14	802373.....	303
802061.....	31	802183.....	13, 15	802274.....	14	802374.....	303
802062.....	31	802184.....	13, 14	802275.....	15	802375.....	303
802065.....	300	802185.....	10	802276.....	15	802376.....	303
802066.....	11	802186.....	10	802277.....	15	802377.....	303
802067.....	12	802187.....	297	802279.....	15	802378.....	303, 304
802068.....	13	802188.....	174	802280.....	15	802379.....	303
802069.....	301	802189.....	202	802281.....	293	802380.....	303
802070.....	13	802191.....	299	802282.....	56	802381.....	303
802073.....	11	802192.....	293	802283.....	16	802382.....	303
802074.....	12	802194.....	29	802285.....	41	802383.....	304
802075.....	13	802195.....	297	802286.....	41	802384.....	304
802076.....	13, 14	802197.....	297	802287.....	38, 44, 45, 46	802385.....	304
802077.....	13, 14	802199.....	308	802287CNVRSN.....	38	802386.....	304
802078.....	13, 14	802203.....	306	802288.....	38	802387.....	304
802079.....	14	802205.....	293	802289.....	38	802388.....	304
802080.....	14	802206.....	293	802290.....	38	802389.....	304
802081.....	14	802208.....	302	802291.....	162	802393.....	292
802082.....	299	802209.....	302	802292.....	300	802396.....	10
802083.....	299	802210.....	302	802293.....	69, 71, 75	802397.....	301
802084.....	182	802212.....	299	802295.....	159	802421.....	173
802085.....	12	802214.....	297	802296.....	46	802422.....	301
802100.....	249	802215.....	297	802297.....	51	802423.....	301
802101.....	249	802216.....	297	802298.....	298	802426.....	309
802106.....	37	802217.....	297	802299.....	301	802427.....	309
802107.....	37	802218.....	13, 17	802302.....	297	802428.....	309
802110.....	159	802219.....	301	802304.....	10	802430.....	310
802111.....	313	802221.....	298	802305.....	9	802435.....	164
802113.....	312	802222.....	299	802306.....	10	802444.....	211
802114.....	312	802223.....	299	802307.....	307	802445.....	312
802115.....	312	802224.....	299	802308.....	60	802446.....	164
802116X1.....	311	802225.....	299	802309.....	60	802447x1.....	36
802116X2.....	311	802226.....	299	802310.....	301	802447x2.....	36
802116X3.....	311	802227.....	299	802312.....	8	802447x3.....	36
802116X4.....	311	802228.....	299	802313.....	8	802447x4.....	36
802116X5.....	311	802229.....	299	802314.....	8	802449.....	202

802450.....	301	911600.....	263	1312553W	23	1314307.....	23, 113, 114, 117, 118, 124, 125, 128
802463.....	168	954301.....	92	1312590.....	141	1314319.....	184
802465.....	292	1312008.....	143	1312591.....	141	1314322.....	192
802470X1.....	36	1312038.....	69, 70, 88	1312596P.....	103	1314346.....	132
802470X2.....	36	1312042V.....	21	1312597P.....	103	1314347X1.....	132
802470X3.....	36	1312042W.....	21	1312640X1.....	43, 44, 45, 46	1314350.....	47
802470X4.....	36	1312069.....	182	1312643.....	47	1314351.....	48
802471.....	38	1312081.....	182	1312643X1.....	45, 46, 47	1314354.....	48
802472.....	38	1312088W.....	120, 121, 122, 123, 124, 125, 126, 127, 128, 192	1312643X3.....	44, 46, 47	1314355.....	48
802473.....	38	1312089P.....	192	1312646.....	43	1314356.....	48
802474.....	38	1312089W.....	192	1312647.....	43, 45, 46	1314485.....	102
802475.....	38	1312118P.....	134	1312666.....	197	1314487.....	102
802476.....	38	1312156.....	138	1312669.....	88	1314488.....	102
802479X1.....	314	1312157.....	138	1312676.....	194	1314492.....	102
802479X2.....	314	1312185.....	22	1312677.....	194	1314493.....	102
802479X3.....	314	1312185W.....	113, 114, 115, 117, 118, 124, 125, 126, 127, 128	1312681.....	196	1314494.....	134
802479X4.....	314	1312210.....	211	1312694.....	194, 196	1314495.....	134
802480X1.....	314	1312246.....	40	1312797.....	198	1314620.....	135
802480X2.....	314	1312260.....	131	1312816.....	20	1314621.....	135
802480X3.....	314	1312261.....	131	1312840.....	139	1314628.....	143
802480X4.....	314	1312262.....	131	1312841.....	139	1314629.....	143
802481X1.....	314	1312264.....	131	1312844.....	89	1314669.....	143
802481X2.....	314	1312265.....	131	1312867.....	197	1314710.....	94, 95, 96
802481X3.....	314	1312315.....	196	1312868.....	198	1314713.....	94, 95, 96
802481X4.....	314	1312320.....	211	1312869.....	195	1314716.....	94, 100
802482.....	293	1312331.....	141	1312872.....	95, 96, 97	1314745.....	213
802483.....	145	1312347.....	189	1312884.....	103	1314750.....	172
802484.....	33	1312352.....	133	1312885.....	103	1314754-5.....	172
802485X1.....	314	1312357.....	133	1312902.....	140	1314761W.....	21, 113, 124
802485X2.....	314	1312369.....	41	1312903.....	140	1314763W.....	21, 117, 124
802485X3.....	314	1312370.....	41	1312905.....	140	1314765V.....	21, 114, 124, 125, 126
802485X4.....	314	1312378.....	194	1312925.....	138	1314765W	21, 113, 114, 115, 117, 118, 124, 125, 126, 127
802485X5.....	314	1312387.....	196	1312959.....	211	1314768W	21
802497.....	13	1312389.....	196	1312960.....	88	1314773V.....	21, 114, 124, 125, 126
802501.....	317	1312390.....	198	1312966.....	195	1314773W.....	21, 113, 124
802502.....	317	1312391.....	198	1312967.....	195	1314774W.....	21, 118, 124
802503.....	38	1312401.....	101, 102, 103	1312971P.....	213	1314792.....	20
802504.....	38	1312406.....	102	1312973P.....	213	1314793.....	20
802505.....	38	1312407.....	101, 102, 103	1313246.....	37	1314798.....	20
802506.....	38	1312408.....	102, 103, 104, 105, 106, 107	1313432.....	37	1314799.....	20
802508.....	19	1312412.....	102	1314089.....	89	1314802.....	54, 120, 121, 124, 125, 126, 127, 128
802509.....	19	1312413.....	102	1314115.....	88	1314803.....	54, 120, 121, 124, 125, 126, 127, 128
802510X2.....	44	1312416.....	102	1314152P.....	88	1314810B.....	54, 120, 121, 124, 125, 126, 127, 128
802510X3.....	44	1312417.....	102	1314156.....	88	1314833P.....	88
802510X4.....	44	1312418.....	102	1314201.....	102, 103	1314838.....	102
802510X5.....	44	1312419.....	102	1314208.....	103	1314839.....	102
802510X6.....	44	1312420.....	102	1314209.....	103	1314842.....	102
802510X7.....	44	1312421.....	102	1314212.....	102	1314843.....	102
802511.....	308	1312422.....	102	1314213.....	102	1314848.....	102
802513.....	10, 145	1312424.....	102	1314216.....	102	1314849.....	102
802514.....	270	1312425.....	102	1314217.....	102	1314852.....	102
900000.....	316	1312428.....	101	1314222.....	102	1314853.....	102
900001.....	316	1312429.....	101	1314223.....	102	1314856.....	102
900002.....	316	1312432.....	102	1314228.....	103	1314857.....	102
900003.....	316	1312433.....	102	1314229.....	103	1314862.....	102
900004.....	316	1312436.....	102	1314232.....	103	1314863.....	102
900005.....	316	1312437.....	102	1314233.....	103	1314868.....	102
900006.....	316	1312439W	23, 113, 114, 117, 118, 128	1314237.....	103	1314869.....	102
900007.....	316	1312456WP.....	30	1314239.....	103	1314872.....	102
900008.....	316	1312475.....	182	1314243.....	103	1314873.....	102
900009.....	316	1312502.....	103	1314251.....	102, 103	1314879.....	41
900010.....	316	1312503.....	103	1314255.....	102	1314882.....	102
900011.....	316	1312512.....	103	1314257.....	102	1314882X2.....	41
900012.....	316	1312513.....	103	1314258.....	102	1314883.....	102
900013.....	316	1312516.....	103	1314259.....	102	1314902.....	132
900014.....	316	1312517.....	103	1314260.....	102	1314903.....	132
900015.....	316	1312522.....	102	1314261.....	102	1314983.....	211
900016.....	316	1312523.....	102	1314271.....	102	1314995.....	88
900017.....	316	1312526.....	102	1314273.....	102	1315216X2.....	34
900018.....	316	1312527.....	102	1314275.....	102, 103	1316003.....	142
900019.....	316	1312534.....	103	1314277.....	102	1316037.....	140
900020.....	316	1312535.....	103	1314300V.....	21, 114, 124, 125, 126		
905826.....	203	1312538.....	103	1314300W	21, 113, 114, 115, 117, 118, 119, 124, 125, 126, 127		
908051.....	157	1312539.....	103				
		1312541.....	103				

1316047.....	140	1321035.....	103, 104, 105	1326021.....	55	1327110.....	105, 106
1316120.....	143	1321036.....	103, 104	1326084.....	140	1327111.....	105, 106
1316122.....	134	1321037.....	104, 105	1326085.....	140	1327116.....	105
1316123.....	134	1321050.....	103, 104	1326099W.....	105	1327117.....	105
1319176-7.....	29	1321051.....	103, 104	1326122.....	89	1327122.....	105
1319182-3.....	29, 45, 46	1321052.....	103, 104	1326147.....	23	1327123.....	105
1319242.....	43	1321053.....	103, 104	1326172WP.....	192	1327195.....	132
1320005P.....	23	1321054.....	103	1326250.....	141	1327200.....	49
1320010V.....	23, 114, 125, 126	1321055.....	103	1326251.....	141	1327344.....	144
1320036.....	139	1321056.....	104	1326254.....	141	1327345.....	144
1320037.....	139	1321057.....	104	1326255.....	141	1327397.....	59, 70
1320056P.....	140	1321058.....	103	1326260.....	141	1327430.....	47
1320057P.....	140	1321059.....	103	1326264.....	141	1327431.....	48
1320063.....	138	1321066.....	103	1326268.....	141	1327500P.....	89
1320087.....	88	1321067.....	103	1326269.....	141	1327512P.....	143
1320089.....	198	1321068.....	104	1326272.....	141	1327543P.....	89
1320103.....	140	1321069.....	104	1326292.....	193	1327593.....	182
1320111.....	144	1321071.....	104	1326293.....	193	1327622.....	143
1320130.....	141	1321101.....	105	1326408.....	138	1327623.....	143
1320131.....	141	1321106.....	103, 105	1326409.....	138	1327627.....	24
1320133WP.....	23, 117	1321114.....	104	1326426.....	139	1327632.....	48
1320142.....	60, 71	1321115.....	104	1326427.....	139	1327633.....	48
1320181X1.....	259	1321116.....	104	1326485.....	172	1327719.....	51
1320196-7.....	141	1321117.....	104	1326488.....	172	1327742.....	141
1320232.....	140	1321122.....	104	1326498.....	138	1327743.....	141
1320233.....	140	1321123.....	104	1326502W.....	195	1327744.....	141
1320236P.....	139	1321146.....	93	1326503W.....	195	1327882-3.....	131
1320237P.....	139	1321150.....	133	1326507.....	196	1327965.....	195
1320361.....	198	1321155.....	129, 130, 133	1326508.....	196	1328060X7.....	25
1320362.....	196	1321156.....	134	1326515.....	196	1328061.....	25
1320363.....	196	1321895.....	42	1326516.....	198	1328062.....	25
1320364.....	197	1322501.....	49	1326518.....	198	1328063.....	25
1320376.....	89	1322506.....	52	1326520.....	194	1328064.....	25
1320379.....	89	1322512.....	53	1326522.....	195	1328065.....	25
1320404.....	104, 106	1322514.....	132	1326529.....	196	1328084.....	143
1320410.....	95, 96	1322516.....	132	1326550.....	140	1328096.....	140
1320418.....	142	1323034.....	103	1326592.....	24	1328126.....	140
1320422.....	9	1323035.....	103	1326593.....	24	1328129.....	140
1320423.....	9	1323042.....	133	1326617.....	195	1328248.....	138
1320430.....	25	1323056.....	140	1326650.....	33, 289	1328249.....	138
1320430X10.....	25, 114, 115, 117, 118, 126, 127	1323071V.....	21	1326658.....	30	1328300.....	106, 107
1320431.....	25	1323071W.....	21	1326660P.....	30	1328301.....	106, 107
1320432.....	25	1323079.....	142	1326666.....	88	1328312.....	106, 107
1320433.....	25	1323102.....	40	1326671.....	88	1328313.....	106
1320434.....	25	1323125.....	89	1326721W.....	24	1328316.....	106
1320435.....	25	1323137.....	198	1326754.....	140	1328317.....	107
1320436.....	25	1323138.....	197	1326772.....	140	1328326.....	106, 107
1320437.....	25	1323150.....	23	1326773.....	140	1328327.....	106, 107
1320438.....	25	1323161.....	143	1326828.....	193	1328328.....	106
1320479P.....	30	1323162.....	144	1326829.....	193	1328329.....	106
1320499.....	138	1323164.....	144	1326832.....	193	1328335.....	106, 107
1320574.....	143	1323165.....	144	1326833.....	193	1328338.....	106, 107
1320600.....	143	1323178.....	139	1326834.....	193	1328339.....	106, 107
1320601.....	143	1323179.....	139	1326837.....	192, 193	1328344X1.....	106
1320603.....	143	1323180.....	172	1326844.....	193	1328345X1.....	106
1320695.....	23, 114, 124, 125, 126	1323200.....	138	1326845.....	193	1328346X1.....	107
1320701.....	52	1323201.....	138	1326885.....	38	1328347X1.....	107
1320718X.....	71	1323209.....	138	1326920.....	105	1328350.....	106, 107
1320725.....	61, 70, 74, 76, 79, 80, 82	1323280.....	141	1326921.....	105	1328352X1.....	106, 107
1320750.....	52	1323303.....	142	1326922.....	105, 106	1328366.....	106
1320751.....	52	1323345W.....	22	1326923.....	105, 106	1328367.....	106
1320775.....	198	1323370.....	143	1326924.....	105, 106	1328368.....	106
1320818W.....	23	1323371.....	143	1326925.....	105, 106	1328369.....	106, 107
1320818W-9W.....	23	1323374.....	144	1326950.....	105	1328370.....	107
1320862.....	104	1323384W.....	41	1326951.....	105	1328371.....	106
1320863.....	104	1323396.....	140	1326952.....	105	1328372.....	106
1320879.....	29	1323418.....	140	1326953.....	105	1328380X1.....	106
1320880.....	29	1323419.....	140	1326954.....	105	1328381X1.....	106
1320881.....	29	1323466.....	142	1326961.....	95, 96	1328382X1.....	106
1320899.....	88	1323474.....	142	1326976.....	105, 106, 107	1328383X1.....	106
1320902.....	195	1323486P.....	89	1326979.....	105, 107	1328384X1.....	106
1320915.....	196	1323487P.....	89	1326990.....	105, 106	1328385X1.....	106
1320916.....	198	1323506.....	131	1326991.....	105, 106	1328386X1.....	106
1320917.....	195	1323508.....	131	1326992.....	105, 106	1328387X1.....	106
1320924.....	196	1323509.....	131	1326993.....	105, 106	1328394.....	106
1320940W.....	21, 114, 124, 125, 126	1323529.....	131	1326994.....	105	1328402.....	138
1320941V.....	23, 114, 116, 120, 125, 126	1323536.....	143	1326995.....	105	1328426.....	140
1321002.....	103, 104	1323576.....	194	1327010.....	89	1328440X1.....	106
1321008.....	103, 104, 105, 106, 107	1323628W.....	23	1327011.....	89	1328441X1.....	106
1321009.....	103, 104, 105, 106	1323635.....	49	1327014-5.....	114, 125, 126	1328442X1.....	106
1321020.....	103, 104	1323655.....	213	1327014-5W.....	24, 114	1328443X1.....	106
1321021.....	103, 104	1324100.....	42	1327025.....	88	1328445X1.....	106
1321022.....	103, 104	1324127.....	259	1327026.....	88	1328446X1.....	106
1321023.....	103, 104	1326014.....	140	1327050.....	53	1328454.....	61, 70, 74, 79, 80, 82, 84
1321034.....	103, 104, 105	1326015.....	140	1327052.....	53	1328470.....	51
		1326020.....	55	1327053.....	53	1328471.....	51

1328478W.....	51	1332061.....	187	1336008.....	140	1337003.....	140
1328479W.....	51	1332093X2.....	73, 74, 75, 76, 77, 78, 79, 80, 81, 84, 88	1336009.....	140	1337060-1.....	74
1328759X1.....	219	1332126.....	106, 107, 108	1336042.....	48	1337064.....	89
1328759X2.....	219	1332127.....	106, 107, 108	1336043.....	48	1337080.....	86
1328759X3.....	219	1332132.....	106, 108	1336050.....	143	1337081.....	86
1328759X4.....	219	1332133.....	106, 107, 108	1336051.....	143	1337107.....	20
1328759X5.....	219	1332138.....	107, 109	1336068.....	144	1337107X20.....	20, 129, 130
1328759X6.....	219	1332140.....	107, 109	1336069.....	144	1337115.....	195
1328759X7.....	219	1332146.....	106, 107, 108	1336080.....	144	1337166.....	60, 75
1328759X9.....	219	1332158.....	106, 108	1336081.....	144	1337170.....	87
1328759X10.....	219	1332159.....	106, 108	1336086.....	144	1337171.....	87
1328759X11.....	219	1332160.....	106	1336087.....	144	1337172.....	136
1329324.....	37	1332161.....	106	1336124.....	53	1337173.....	136
1330120P.....	192	1332162.....	106	1336125.....	53	1337186.....	24, 115, 127
1330186.....	145	1332163.....	106	1336170.....	135	1337188.....	24, 115, 127
1331020.....	55	1332168.....	106	1336171.....	136	1337216.....	33, 289
1331021.....	55	1332169.....	106	1336177.....	54, 136	1337293.....	37, 46
1331204.....	50	1332170.....	106, 107	1336184.....	53	1337295.....	37, 46
1331208.....	49	1332171.....	106, 107	1336185.....	53	1337296.....	37
1331212.....	52	1332180.....	107, 109	1336212.....	108	1337298.....	37, 44, 45
1331213.....	52	1332181.....	107, 109	1336213.....	108	1337304.....	289
1331214.....	52	1332190.....	107	1336216.....	89	1337305.....	289
1331215.....	52	1332191.....	107	1336217.....	89	1337306.....	139
1331216.....	53	1332198.....	107, 108	1336221W.....	89	1337316.....	48
1331217.....	53	1332218-9W.....	114, 115, 126, 127	1336222.....	197	1337317.....	48
1331219.....	53	1332218W.....	24	1336223.....	197	1337319.....	136
1331277.....	143	1332219W.....	24	1336238.....	142	1337329.....	141
1331316.....	143	1332235W.....	21, 115	1336239.....	142	1337340.....	136
1331340.....	143	1332236W.....	21, 115	1336245.....	136	1337344-5.....	70, 71, 72, 73, 74, 75, 76, 77, 78, 79, 84
1331374.....	182	1332237W.....	22, 115	1336248.....	136	1337350.....	136
1331415P.....	192	1332238.....	24, 114, 126	1336251.....	196	1338014.....	142
1331415W.....	192	1332243.....	24, 114, 115, 126	1336260.....	48	1338015.....	142
1331426.....	198	1332310-1.....	61, 70, 74, 76, 79	1336261.....	48	1338022.....	55
1331429.....	198	1332328.....	197	1336276.....	144	1338023.....	55
1331432.....	193	1332329.....	197	1336277.....	144	1338025P.....	143
1331444.....	142	1332334.....	186, 187, 188	1336290.....	52	1338057.....	143
1331445.....	142	1332355.....	53	1336350.....	53	1338058.....	143
1331452.....	140	1332356.....	53	1336351.....	53	1338058.....	143
1331453.....	140	1332380.....	49	1336374.....	53	1338100.....	142
1331458.....	140	1332381.....	49	1336389WP.....	24, 115	1338128.....	138
1331459.....	140	1332393.....	196	1336390.....	136	1338166.....	142
1331508.....	48	1332400.....	50	1336391.....	136	1338167.....	142
1331509.....	48	1332401.....	50	1336396.....	136	1338168.....	142
1331524.....	172	1332422.....	141	1336399P.....	136	1338208.....	55
1331529.....	141	1332466.....	259	1336422.....	136, 137	1338210.....	55
1331532.....	144	1332472.....	96, 97	1336437.....	136	1338211.....	55
1331554.....	198	1332473.....	96, 97	1336588.....	142	1338234.....	86
1331620-1.....	70, 74, 76, 79, 80, 82	1332478.....	259	1336589.....	142	1338235W.....	89
1331630P.....	30	1332512X1.....	34	1336600.....	54	1338246W.....	89
1331632.....	144	1332574.....	40, 46	1336601.....	54	1338248.....	142
1331636.....	134	1332600.....	195	1336606P.....	136	1338249.....	142
1331637.....	134	1332601.....	195	1336610P.....	136	1338251.....	141
1331665.....	187, 188	1332602.....	195, 198	1336668.....	136	1338252.....	141
1331670.....	133	1332603.....	195	1336669.....	136	1338256.....	133
1331676.....	196	1332769.....	32	1336686.....	136	1338279.....	144
1331677.....	198	1332934.....	108	1336713P.....	87	1338282.....	144
1331716.....	47	1332935.....	108	1336715P.....	87	1338283.....	144
1331717.....	48	1333004.....	37	1336720.....	87	1338285.....	144
1331722.....	196	1333060-1W.....	26, 44, 45	1336721.....	86	1338313W.....	24, 115
1331728.....	196	1333074.....	26	1336724.....	87	1338330.....	182
1331752.....	139	1333075.....	26	1336726.....	87	1338332.....	182
1331753.....	139	1333084.....	26	1336727.....	87	1338334.....	144
1331759.....	142	1333085.....	26	1336732.....	87	1338335.....	144
1331760.....	141	1333196.....	26	1336733.....	87	1338353.....	145
1331762P.....	139, 146	1333198.....	26	1336740.....	87	1338370.....	136
1331763P.....	139, 146	1333199.....	26	1336741.....	87	1338371.....	136
1331774.....	196	1333226X1.....	26	1336750.....	87	1338401.....	139
1331782.....	140	1333385.....	26	1336751.....	87	1338420.....	139
1331783.....	140	1333574.....	43, 44, 45, 46	1336798.....	86	1338421.....	139
1331785.....	140	1333579.....	41	1336800.....	136	1338424.....	141
1331803.....	91	1333592X1.....	41	1336807.....	89, 136	1338426.....	134
1331825.....	189	1333595X1.....	41	1336820.....	30	1338427.....	134
1331828-9.....	88	1333596W.....	41	1336862.....	49	1338475.....	87
1331840.....	89	1333980.....	26	1336863.....	49	1338484.....	192
1331841.....	89	1333981.....	26	1336875.....	182	1338502.....	140
1331874.....	141	1333990.....	26	1336880.....	134	1338503.....	140
1331888.....	144	1333991.....	26	1336881.....	134	1338504.....	140
1331889.....	144	1334322X1.....	34	1336936.....	107	1338522.....	142
1331894.....	144	1334322X5.....	34	1336937.....	107	1338523.....	142
1331895.....	144	1334375X1.....	34	1336946.....	108	1338564.....	139
1331896.....	144	1334393.....	43	1336947.....	108	1338569P.....	29
1331897.....	144	1334473.....	135	1336948.....	108	1338574.....	141
1331926-7.....	74, 76, 79	1334798.....	87	1336949.....	108	1338590.....	142
1331996-7.....	74, 76, 79, 80, 82	1334823.....	87	1336954.....	106, 108	1338591.....	142
1332039.....	134	1334868.....	87	1336983.....	136	1338602.....	140
1332060.....	187			1337002.....	140	1338603.....	140

1338604.....	140	1339518.....	109	1342828.....	30	1343541.....	196
1338605.....	140	1339519.....	109	1342829.....	53	1343541X1.....	196
1338622.....	88	1339521.....	218	1342844.....	53	1343542.....	198
1338623.....	88	1339524W.....	218	1342852.....	53	1343543.....	198
1338630.....	53	1339574X1.....	73, 74, 75, 76, 77, 78, 79, 80, 81, 82, 83, 84, 88	1342853.....	53	1343546V.....	22, 116, 120
1338631.....	53			1342870.....	53	1343548W.....	24, 116, 120
1338632.....	53	1339590X1.....	87	1342909.....	109, 110	1343573.....	143
1338633.....	53	1339590X2.....	87	1342910.....	109	1343588.....	109
1338674.....	193	1339618.....	143	1342914.....	109	1343589.....	109
1338678.....	193	1339709.....	93	1342915.....	109	1343590.....	116, 120, 197
1338681.....	195	1339710.....	218	1342945.....	192	1343594.....	109
1338684.....	197	1339718.....	92	1343011.....	139	1343595.....	109
1338685.....	197	1339735.....	193	1343015.....	139	1343599.....	109
1338686.....	198	1339736.....	193	1343046.....	133	1343604.....	109
1338690.....	195	1339737.....	193	1343060.....	194	1343605.....	109
1338692.....	197	1339774.....	193	1343061.....	194	1343607.....	109
1338693.....	198	1339775.....	193	1343064.....	198	1343612.....	109
1338708P.....	136	1339776.....	48	1343065.....	198	1343613.....	109
1338724.....	135	1339777.....	48	1343100.....	47	1343627.....	55
1338766.....	188	1339790X1.....	136	1343101.....	48	1343628.....	55
1338767.....	188	1340086.....	136	1343119.....	59, 74, 75, 76, 77, 78, 79	1343630.....	53
1338774.....	52	1340087.....	136	1343150.....	48	1343631.....	53
1338775.....	52	1340097.....	37	1343151.....	48	1343706W.....	24, 120, 121
1338778.....	87	1340108-9X17.....	26	1343160W.....	25	1343707W.....	24, 120, 121
1338802.....	108, 109	1340108-9X23.....	26	1343160X10.....	25, 115, 116, 118	1343726.....	59, 79
1338803.....	108, 109	1340108-9X24.....	26	1343161W.....	25	1343730.....	49
1338806.....	108, 109	1340161X1.....	34	1343162W.....	25	1343734.....	49
1338807.....	108, 109	1340161X2.....	34	1343163W.....	25	1343741.....	49
1338812.....	108, 109	1340161X3.....	34	1343164W.....	25	1343760.....	48
1338813.....	108, 109	1340161X4.....	34	1343165W.....	25	1343761.....	48
1338814.....	108	1340161X5.....	34	1343166W.....	25	1343776.....	144
1338815.....	108	1340161X6.....	34	1343167W.....	25	1343777.....	144
1338816.....	108, 109, 111	1340161X7.....	34	1343168W.....	25	1343782.....	37, 46
1338818.....	108, 109	1340161X8.....	34	1343170.....	136	1343800.....	218
1338819.....	108, 109	1340324X1.....	41	1343182.....	109	1343922.....	109
1338826.....	108	1340326.....	41	1343183.....	109	1343923.....	109
1338827.....	108	1340327X1.....	41	1343184.....	109	1343926.....	109
1338828.....	108	1340330.....	42	1343185.....	109	1343927.....	109
1338829.....	108	1340346.....	41	1343186.....	109	1343930.....	109
1338830.....	108	1340392-3.....	29	1343187.....	109	1343931.....	109
1338831.....	108	1340427X1.....	37	1343188.....	109	1343934.....	109
1338834.....	108	1342286.....	52	1343189.....	109	1343935.....	109
1338835.....	108	1342287.....	52	1343192-3.....	60	1343942X61.....	34
1338837.....	108	1342288.....	52	1343201X1.....	34	1343944X61.....	34
1338842.....	109	1342292.....	144	1343201X4.....	34	1343976.....	98
1338843.....	109	1342293.....	144	1343201X5.....	34	1343978.....	98
1338844.....	108	1342298.....	52	1343201X6.....	34	1343998.....	52
1338845.....	108	1342302.....	142	1343201X7.....	34	1343999.....	52
1338846.....	109	1342320.....	142	1343201X8.....	34	1344004.....	37
1338847.....	109	1342321.....	142	1343202X1.....	34	1344053.....	26
1338866.....	51	1342324.....	142	1343202X4.....	34	1344340.....	42
1338883.....	198	1342325.....	142	1343202X6.....	34	1344441.....	29
1338884.....	194	1342326.....	142	1343202X8.....	34	1344441X3.....	29
1338885.....	194	1342327.....	142	1343204X1.....	33	1344444.....	29, 44, 46
1338907.....	60	1342452.....	52	1343204X5.....	33	1344444X2.....	29
1338965.....	136	1342465.....	192	1343204X6.....	33	1344882.....	34
1338984.....	87	1342468.....	143	1343204X7.....	33	1346528-9.....	29, 44
1339014.....	86	1342484.....	134	1343227.....	54, 136	1346626X1.....	37
1339015.....	74, 82, 87	1342485.....	134	1343230W.....	25	1346637X1.....	37
1339019.....	41	1342505.....	143	1343230X8.....	116	1346972.....	29
1339022.....	41	1342512.....	138	1343230X8W.....	25, 115, 118	1347000.....	50
1339030.....	52	1342523W.....	89	1343231W.....	25	1347005.....	61, 70, 79
1339050.....	54	1342524W.....	89	1343232W.....	25	1347006-7.....	61, 70, 79
1339051.....	54	1342524WX1.....	89	1343233W.....	25	1347010-1.....	79
1339055.....	21	1342542.....	140	1343240W.....	23, 115, 116	1347012-3.....	79
1339067.....	87	1342543.....	140	1343241VP.....	23, 113, 116, 122, 123	1347014-5.....	70, 79
1339110.....	139	1342577.....	172	1343244.....	22	1347016-7.....	79
1339111.....	139	1342590.....	55	1343244X1.....	22	1347074.....	60, 69, 70, 79
1339120.....	96, 97, 98, 99	1342600.....	289	1343245V.....	24	1347409.....	26
1339147.....	141	1342601.....	289	1343245W.....	24	1347499.....	38
1339198.....	144	1342625.....	196	1343246V.....	24, 115, 116	1347540.....	42
1339213.....	138	1342627.....	198	1343246W.....	24	1347540X1.....	42
1339214.....	192	1342630.....	196	1343266.....	109	1347584R.....	29
1339224.....	186, 189	1342656.....	30	1343267.....	109	1347666-7.....	38
1339259X1.....	29, 44	1342658.....	30	1343268.....	109	1347700-1.....	29
1339259X2.....	29	1342662.....	196	1343269.....	109	1347718W.....	41
1339270X1.....	39	1342665.....	198	1343314.....	40, 46	1347729.....	26
1339323.....	259	1342700.....	142	1343342.....	79	1347779.....	218
1339330.....	211	1342706.....	139	1343354.....	47	1347780W.....	26
1339332.....	211	1342707.....	139	1343355.....	48	1347788.....	34
1339390.....	259	1342728.....	109, 110	1343377.....	133	1347794.....	42
1339394W.....	22	1342729.....	109, 110	1343378.....	40, 134	1347846.....	37
1339395.....	86	1342775.....	22	1343456.....	198	1347860-1.....	38
1339396.....	211	1342775W.....	115, 116, 118	1343484.....	109	1347877.....	218
1339477.....	213	1342775X1.....	22	1343504.....	89	1348276P.....	187
1339492.....	140	1342826.....	53	1343505.....	89	1350045.....	91
1339493.....	140	1342827.....	53	1343540.....	196	1350105.....	55

1350106X1	197	1351089	39	1352529	137	1353511	110
1350107	198	1351119	42	1352531	143	1353516	52
1350108	197	1351136-7	37	1352546	137	1353517	52
1350164-5	84	1351150	29	1352600	48	1353518	52
1350181	289	1351153W	24, 117, 118, 119	1352601	48	1353524	196
1350188W	43	1351154WP	24	1352602	47	1353530	24
1350189W	43	1351155V	22	1352603	48	1353530W	116, 120
1350216	29	1351155W	22, 117, 118, 119	1352633	49	1353535W	89, 120
1350219	26	1351167V	24	1352634	49	1353542	197
1350230	91	1351167W	24, 117, 118, 119	1352635	49	1353543	195
1350251X1	213	1351170	134	1352636	52	1353544	198
1350256	196	1351214W	39	1352637	52	1353545	198
1350256X1	196	1351215W	39	1352639	52	1353546W	137
1350257	196	1351226W	24, 117, 118, 119	1352640	52	1353558	137
1350257X1	196	1351263	137, 211	1352641	52	1353564	137
1350258	195	1351310	55	1352644-5	60	1353600	134, 137
1350259	195	1351311	55	1352646-7	60	1353601	134, 137
1350260	198	1351334-5	84	1352649	60	1353620	196
1350271	258	1351350	132	1352655	50	1353630	143
1350294	196	1351351	132	1352662-3	61, 80, 82	1353637	141
1350295	196	1351370	88	1352683	29	1353648	139
1350296	198	1351407	79, 88	1352690X4	34	1353655	197
1350320	289	1351408	33, 289	1352704W	89	1353661	197
1350321	289	1351434	40	1352730	140	1353680	49
1350397	118, 119, 193	1351450	211	1352731	140	1353681	49
1350398	193	1351452	211	1352750	144	1353682	49
1350399	193	1351588	30	1352766	142	1353683	49
1350414W	43	1351626-7	61	1352786W	32	1353684	49
1350415W	43	1351654	50	1352822	41	1353685	49
1350423	132	1351655	50	1352831	137	1353686	49
1350427	132	1351680	50	1352834	142	1353687	49
1350430	132	1351700	52	1352890V	22	1353688	49
1350434	259	1351701	80, 88	1352974	88	1353689	49
1350435	259	1351702	52	1353005	194	1353694	49
1350460W	54	1351703	52	1353080	25	1353695	49
1350461W	54	1351710	52	1353127	98, 99	1353700	137
1350462W	54	1351711	52	1353160	131	1353706	47, 137
1350463	54	1351730-1	80, 81	1353161	131	1353735V	24, 116, 120
1350464W	54	1351742-3	81	1353170	198	1353740	137
1350465W	54	1351744-5	81, 83	1353202	110	1353741	197
1350472	55	1351746-7	80, 82	1353203	110	1353744	87
1350475	208	1351774	131	1353206	110	1353747	137
1350498	24, 117, 119	1351778	131	1353207	110	1353798	110
1350504	195	1351779	131	1353212	110	1353799	110
1350520x1	34	1351791	52	1353213	110	1353802	37, 46
1350520x2	34	1351857	211	1353214	110	1353806	137
1350533W	118, 119, 193	1351880	193	1353216	110	1353821	40
1350534W	118, 119, 193	1351885	193	1353217	110	1353823	134, 137
1350538	84	1351886	193	1353236	110	1353824	134, 137
1350561	50	1351887	193	1353237	110	1353826	49
1350562	50	1351888	193	1353238	110	1353827	49
1350563	50	1351891	192, 193	1353239	110	1353847	34
1350564-5	84	1352008	142	1353240	110	1353850	197
1350572-3	84	1352009	142	1353241	110	1353851	197
1350577	84	1352012	142	1353254	110	1353855	139
1350604	172	1352013	142	1353255	110	1353857	139
1350642	55	1352164	133	1353256	110	1353898-9	61
1350643	55	1352164X2	133	1353257	110	1353900	137
1350675	33	1352168	133	1353262	110	1353927	137
1350680	53	1352168X2	133	1353263	110	1353929	88
1350682	53	1352169	133	1353275	198	1353952	110
1350683	53	1352169X2	133	1353277	110	1353953	110
1350690	37	1352180	143	1353284	144	1353955	143
1350700	53	1352186	143	1353285	144	1353991	144
1350702	53	1352189	143	1353289	144	1354090	34
1350703	53	1352190	144	1353291	137	1354091	34
1350724	49	1352191	144	1353324	197	1354104X3	33
1350725	49	1352229	137	1353330	50	1354104X4	33
1350726	49	1352258	137	1353331	50	1354104X6	33
1350727	49	1352261	143	1353334	50	1354104X7	33
1350764-5	84	1352299	145	1353335	50	1354104X8	33
1350768	198	1352300	131	1353336	50	1354104X11	33
1350769	59, 84	1352301	131	1353346	54, 137	1354230X3	34
1350775	88	1352309	132	1353347	54, 137	1354240X2	34
1350800	134	1352315	55	1353353	137	1354240X3	34
1350837	47	1352316	55	1353355	59, 80, 81, 82	1354240X4	34
1350838	47	1352320	55	1353365	59, 80, 81	1354375	42
1350856-7	84	1352321	55	1353370W	24, 116, 118, 120, 121	1354395	42
1350963	84	1352416	142	1353371	24, 116, 120, 121	1355004	110
1350997	84, 172	1352417	142	1353372	24, 116	1355005	110
1351014	134	1352436	196	1353373	24, 118	1355021	198
1351033	54, 118, 119	1352437	196	1353380	52	1355026	195
1351034X1	54	1352438	198	1353381	52	1355032	110
1351040	211	1352460	137, 208	1353388	197	1355033	110
1351043	209	1352488	92	1353389	197	1355033	110
1351068-9	53	1352528	137	1353390	53	1355040	41
1351088	92			1353391	53	1355041	198
				1353450	137	1355042	24, 116
				1353510	110	1355043	24, 118

1355072	137	1358168	139	1360191	193	1361098	111, 112
1355090	110	1358169	139	1360195	193	1361134X1	87
1355091	110	1358171	139	1360198	193	1361134X2	87
1355092	110	1358172	139	1360350-1	80, 81, 83	1361135X1	87
1355093	110	1358173	139	1360427	48	1361135X2	87
1355100	137	1358200	197	1360488W	22	1361140	143
1355101	137	1358204W	116, 117, 118	1360489W	22, 118	1361368	111
1355106	137	1358204WVP	24	1360490W	22, 116, 118, 121	1361369	111
1355107	137	1358212	52	1360492W	22	1361370	111
1355125W	116, 120, 197	1358230	48	1360493W	22, 116, 117	1361371	111
1355225	143	1358231	48	1360494W	22, 116	1361372	111
1355244	137	1358257	55	1360495W	22, 116, 121	1361373	111
1355257	32	1358264	99	1360504	25	1361400	42
1355288	137	1358400	49	1360505	25	1361471	61
1355352-3	80, 81, 83	1358401	49	1360535	137	1361734	25
1355402	143	1358402	49	1360552	111	1361735	25
1355403	137	1358403	49	1360553	111	1361736	25
1355408	54, 137	1358418	49	1360563	99	1361737	25
1355409	54, 137	1358424P	143	1360577	134, 137	1361747	111, 112
1355430	21	1358450	53	1360578	134, 137	1361800	194
1355438W	24	1358451	53	1360648	30	1361801	194
1355439W	24	1358452	53	1360694	197	1361804	198
1355518	137	1358453	53	1360695	197	1361806	196
1355519	137	1358464	53	1360697	197	1361807	196
1355806-7	60	1358465	53	1360810	55	1361857WP	25
1355869	26	1358497	59, 83	1360811	55	1362012	54
1356084	139	1358516-7	60, 82	1360837	134	1362014	99, 100
1356085	139	1358530	144	1360838	134, 137	1362033	40
1356106	89	1358534	142	1360846	40	1362038	133
1356110	138	1358535	142	1360849	40, 134	1362049X1	30
1356136	140	1358549	133	1360872	47	1362090	142
1356137	140	1358553	32	1360873	48	1362106X1	89
1356180	88	1358562W	25	1360874	48	1362106X2	89
1356181	88	1358563W	25	1360875	48	1362116	194
1356192	143	1358580	22	1360876	48	1362117	194
1356193	143	1358580W	116, 117, 118, 121	1360877	48	1362118P	194
1356202	192	1358585	137	1360878	48	1362118W	194
1356203	192	1358672	111	1360879	48	1362119P	194
1356216	193	1358675	88	1360888	47	1362119W	194
1356217	193	1358695	55	1360889	48	1362166WP	25
1356220	195	1358708	89	1360890	134	1362167WP	25
1356220X	195	1358711W	43	1360891	134	1362168WP	25
1356221	195	1358712W	43	1360896-7	84	1362171X2	25
1356221X	195	1358715	198	1360900	111	1362190	100
1356226	197	1358716	198	1360901	111	1362209	138
1356227	197	1358717	182	1360902	111	1362245	112
1356228	198	1358720	119, 195	1360903	111	1362246	112
1356250	194	1358722	197	1360904	111	1362247	112
1356251	194	1358726W	24, 117, 119	1360905	111	1362248	112
1356256	194	1358747V	24	1360910	111	1362249	112
1356258	196	1358747W	24, 117, 118, 119	1360911	111	1362250	112
1356259	196	1358767	42	1360912	111	1362251	112
1356262	198	1358783	89	1360913	111	1362252	112
1356263	198	1358784	193	1360914	111	1362253	112
1356264	196	1358786	193	1360915	111	1362254	112
1356265	196	1358787	119, 193	1360916	111	1362255	112
1356317P	29	1358849	193	1360917	111	1362256	112
1356575	142	1358849W	119	1360918	111	1362257	112
1356649	52	1358914	29	1360919	111	1362258	25
1356762	197	1358930	53	1360920	111	1362259	25
1356880	50	1358934	88	1360921	111	1362260	25
1356884	50	1358935	88	1360922	111	1362264	100
1356891	61	1358942W	54	1360923	111	1539022	220
1356900	50	1358943W	54	1360924	111	1539025	264
1356901	50	1358946W	54	1360925	111	1539026	281, 282, 283
1356904	50	1358947W	54	1360926	111	1539027	264
1356909	50	1358964-5	60, 84	1360927	111	1539033W	91
1356924-5	61, 82	1358965	60	1360928	111	1539038	157, 182
1356932	61, 82	1359008-9	29	1360929	111	1539054	161
1356942	60	1359042X1	37	1360930	111	1539058	183
1356950	52	1359044	42	1360931	111	1539059	183
1356951	52	1360022	208	1360932	111	1539065	214
1356953	52	1360025	183	1360933	111	1539081	219
1356959	52	1360042	40, 46	1360934	111	1539084	183
1356975	134	1360043	40	1360935	111	1539087	183
1356991	59, 82, 83	1360074X3	34	1360936	111	1539099	185
1356997	55	1360075X3	34	1360937	111	1539108	183
1356998	55	1360130-1	82	1360938	111	1539109	183
1357726	136, 144	1360132-3	83	1360939	111	1539122	219
1358001	59, 82, 83	1360134-5	83	1360965	111	1539124-5W	90
1358030	137	1360150W	25, 118	1360966	111	1539129	183
1358038	49	1360155W	24, 116, 121	1360967	111	1539157	183
1358039	49	1360160W	22, 116, 121	1360980	120, 121, 127, 131	1539168	196
1358044	54	1360162W	23, 116, 121	1361022	138	1539169	196
1358045	54	1360164	25	1361025	182	1539359	226, 233
1358146	138	1360164W	116, 121	1361026	182	1539364	183
1358147	138	1360180	193	1361047	48	1539366	216
1358166	139	1360181	193	1361050	196	1539412	161
1358167	139	1360190	193	1361051	196	1539416P	90

1539422	223	1540787	185	1541142	244	1541983	186, 188
1539451	207	1540825X1	206	1541143	244	1541991	214
1539452	204	1540826	204	1541144	244	1542004	260
1539469	251	1540830	205	1541146	244	1542005	260
1539470	262	1540831	204	1541156	244	1542007	214
1539472	262	1540836	92	1541157	244	1542138	185
1539479	160	1540837	213	1541166	242	1542151	251
1539484	269	1540839	212	1541169	242	1542157	251
1539489	217, 218, 245	1540900	242	1541171	243	1542173	186
1539500	268	1540906	245	1541172	243	1542174	186, 188
1539556	159	1540909	242, 245	1541173	243	1542245	209
1539567	159	1540916	242	1541174	243	1542247	209
1539568	159	1540922	218, 242	1541175	243	1542260	226
1539579	207	1540930	242	1541176	243	1542263	208
1539580X1	205	1540931	242	1541177	243	1542265	209
1539582X1	205	1540935	219, 242	1541178	243	1542270	212
1539595	226	1540943	244	1541179	243	1542271	212
1539596	214	1540966	244	1541182	242	1542282	212
1539639	159	1540993	244	1541183	242	1542283	212
1539640	159	1540995	244	1541184	242	1542299	173
1539716	204	1541005	245	1541185	242, 243	1542314	233
1539744	220	1541009	245	1541187	243	1542335	183
1539745	220	1541011	245	1541195	243	1542337	178
1539747	220	1541015	245	1541197	243	1542342	28
1539782	207	1541018	245	1541198	243	1542343	28
1539782P	206	1541019	245	1541199	243	1542353	178
1539835	33	1541022	245	1541200	243	1542362	178
1539871	161	1541023	245	1541202	242, 243	1542363	178
1539877	28	1541024	245	1541203	243	1542364	178
1539878	28	1541025	245	1541205	242	1542365	178
1539879	28	1541026	245	1541210	243	1542385	220
1539880	28	1541027	245	1541226	243	1542662	274
1539888	39, 187	1541028	245	1541227	243	1542663	274
1539890	161	1541030	245	1541228	243	1542669	274
1539892	201	1541031	245	1541229	243	1542670	259, 274
1539898	209	1541035	245	1541230	243	1542673	274
1539910-1W	91	1541036	245	1541231	243	1542691	178
1539973	186	1541037	242, 245	1541237	243	1542713P	91
1540006	176	1541038	245	1541238	243	1542747	187
1540033	39, 188	1541039	245	1541239	243	1542751	58
1540059X	267	1541040	245	1541240	243	1542755	57
1540063	208	1541041	245	1541248	243	1542765	178
1540092	187, 188, 189	1541042	245	1541250	242	1542795	214
1540100	187, 188	1541043	245	1541251	245	1542801	178
1540121	28	1541044	245	1541255	242	1542802	178
1540135	208	1541045	245	1541256	242	1542834	178
1540139	58	1541048	244	1541258	242	1542867P	185
1540159	185	1541051	244	1541275X1	206	1542877	173
1540181	212	1541052	244	1541286	28	1542878	173
1540182	213	1541053	244	1541287	28	1542892	173
1540227	222	1541054	244	1541294	257	1542895	173
1540233	212	1541055	244	1541300	257	1542908	178
1540234	212	1541056	244	1541354	243	1542912	178
1540235	212	1541057	244	1541389	216	1542916	178
1540238	177	1541058	244	1541533	217, 222	1542920	178
1540239	177	1541063	244	1541548	244	1542921	178
1540262	173	1541064	244	1541549	244	1542937	178
1540263	173	1541066	244	1541582	196	1542951	223, 226, 231, 232, 233, 235
1540269	200	1541067	244	1541677P	90	1542952	178
1540283	209	1541068	244	1541696	90, 120, 121, 124, 125, 126, 127, 128	1542953	178
1540299	213	1541071	244	1541701	245	1542958	178
1540300	213	1541072	244	1541703	219	1542973	178
1540305	213	1541076	244	1541704	219	1542984	244
1540309	208	1541080	244	1541708P	90	1542992	244
1540310	213	1541082	242, 243	1541709P	90	1543003	249
1540314	25	1541084	242	1541710P	90	1543008	209, 214
1540346	31	1541085	242	1541711P	90	1543038	176
1540369	31	1541087	242	1541732	190	1543053	176
1540370	31	1541089	223, 242	1541778	160	1543054	174
1540373	231	1541092	242, 243	1541790	274	1543055	175
1540383	235	1541093	242	1541806	162	1543059	242
1540389	231, 235	1541094	242	1541844	249	1543064	243
1540390	231, 235	1541095	242	1541845	249	1543070	244
1540393	231, 234	1541096	242	1541865	268	1543076	244
1540394	231, 234	1541097	218, 226, 228, 230, 232, 237, 242	1541866	268	1543079	245
1540395	223, 226, 231, 233, 235	1541099	243	1541868	268	1543085	243
1540398	56	1541100	243	1541917X	267	1543088	243
1540414	56	1541109	243	1541923	175	1543089	243
1540417	56	1541110	243	1541924	175	1543105	257
1540513	30	1541114	242	1541925	175	1543119	233, 235
1540531	39	1541127	242	1541927	175	1543129	220
1540603	158	1541132	244	1541938	274	1543133	274
1540604	158	1541133	244	1541949	214	1543135	274
1540645	175	1541136	244	1541950	214	1543223	264, 277, 279, 280, 281, 282, 283
1540715	32	1541137	244	1541961W	214	1543277	175
1540762	207	1541139	244	1541967	274	1543339	242
1540774	204	1541140	244	1541971	33	1543376	160
1540776	204	1541141	244	1541980	188		

1543382.....	175	1545151.....	234	1547105.....	156	1548593.....	176
1543412X1.....	217	1545152.....	234	1547116.....	159	1548599.....	176
1543412X2.....	217	1545153.....	232, 234	1547196.....	152, 153	1548650.....	284
1543433.....	174	1545154.....	232, 234	1547202-3.....	152	1548652.....	286
1543503.....	90	1545156.....	234	1547204P.....	90	1548689.....	28
1543504.....	90	1545158.....	234	1547205P.....	90	1548690.....	28
1543516.....	173	1545164.....	218	1547208.....	168	1548769.....	184
1543533.....	33	1545165.....	233	1547216P.....	90	1548797.....	209
1543552.....	183	1545166.....	233, 234	1547218P.....	90	1548829.....	190
1543609.....	185	1545168.....	233	1547266.....	180	1548830.....	190
1543617.....	31, 39, 187	1545169.....	234	1547327.....	39	1548831.....	190
1543772.....	32	1545173.....	233, 234	1547329.....	187	1548898.....	32
1543842.....	257	1545174.....	233	1547331.....	187	1548928.....	243
1543843.....	257	1545177.....	233	1547332.....	208	1548985.....	168
1543844.....	257	1545181.....	233	1547334.....	187, 209	1549019X1.....	205
1543903.....	257	1545184.....	233	1547339.....	257	1549100.....	212
1543913.....	247	1545186.....	233	1547343.....	172	1549153.....	187
1543914.....	222, 247	1545187.....	233	1547356.....	209	1549155.....	189
1544020.....	257	1545188.....	233	1547359.....	31	1549157.....	187, 189
1544021.....	257	1545191.....	233	1547360.....	172	1549160.....	189
1544047.....	257	1545192.....	233	1547363.....	257	1549161.....	187
1544050.....	257	1545194.....	233	1547364.....	257	1549213.....	165
1544051.....	257	1545195.....	219, 242	1547373.....	268	1549218.....	152
1544054.....	257	1545197.....	212	1547377.....	214	1549243.....	220
1544080.....	214	1545213.....	233	1547442.....	212	1549247.....	163
1544167.....	203	1545214.....	233	1547457.....	172	1549267.....	173
1544215.....	243	1545215.....	226, 233	1547507.....	216	1549273.....	173
1544247.....	235	1545220.....	185	1547532.....	268	1549296.....	190
1544248.....	235	1545231.....	262	1547533.....	268	1549298.....	190
1544272.....	208	1545251.....	31	1547534.....	268	1549303.....	235
1544273.....	209	1545252.....	31	1547534X.....	267	1549319.....	176
1544278.....	188, 209	1545263.....	32	1547535.....	268	1549333.....	223, 232, 235
1544289.....	152	1545274.....	242	1547535X.....	267	1549342.....	173
1544290.....	152	1545332.....	257	1547536.....	263	1549346.....	187, 189, 209
1544352X.....	267	1545445.....	28	1547537.....	235	1549361P.....	174
1544394R.....	249	1545446.....	28	1547560.....	159	1549377.....	200
1544476.....	161	1545452.....	27	1547562.....	159	1549387.....	203
1544477.....	161	1545458.....	244	1547566.....	177	1549443.....	212
1544481.....	269	1545461.....	244	1547572.....	233	1549444.....	212
1544548.....	188	1545489.....	242, 243	1547573.....	233	1549445.....	212
1544549.....	188	1545491.....	243	1547588.....	164	1549446.....	212
1544586.....	172	1545839.....	243	1547592.....	174	1549452.....	185
1544587.....	183	1545870.....	188	1547598.....	235	1549471.....	157
1544588.....	183	1545886.....	286	1547613.....	27	1549483.....	247
1544589.....	183	1545887.....	286	1547689.....	209	1549564.....	208
1544590.....	183	1545940.....	206	1547690.....	187	1549565.....	187, 189, 209
1544591.....	162	1545946.....	216	1547697.....	187	1549567P.....	257
1544597.....	180	1545961.....	220	1547812W.....	91	1549568P.....	257
1544684W.....	201	1545962.....	190	1547813.....	177	1549575.....	173
1544688P.....	90	1545966.....	190	1547820W.....	90	1549583.....	208
1544710.....	27	1545998.....	174	1547880.....	19	1549590.....	39, 187
1544725.....	165	1546014.....	206	1547885.....	247	1549625.....	266, 284
1544759.....	27	1546041.....	157	1547886.....	247	1549626.....	266, 284
1544760.....	27	1546048.....	190	1547905.....	247	1549627.....	266, 284
1544762.....	27	1546054.....	190	1548177.....	216	1549628.....	266, 284
1544763.....	27	1546084.....	58	1548225.....	189	1549630-33.....	284
1544766.....	233	1546087.....	58	1548251.....	213	1549634-36.....	284
1544767.....	233	1546103.....	216	1548255.....	187	1549638.....	284
1544768.....	27	1546108.....	245	1548276P.....	190	1549639.....	284
1544772.....	27	1546130.....	91	1548277.....	212	1549644.....	286
1544774.....	27	1546133.....	257, 265	1548288.....	161	1549645.....	266, 284
1544801.....	286	1546150.....	223	1548294.....	152	1549648-51.....	284, 285, 287
1544802.....	286	1546219.....	260	1548295.....	220	1549665.....	208
1544803.....	286	1546227.....	89	1548296.....	220	1549671.....	57
1544805.....	286	1546281.....	218	1548302.....	248	1549682.....	32
1544810.....	286	1546282.....	218	1548305.....	186, 187, 189	1549684.....	179
1544815.....	91	1546283.....	218	1548314.....	187	1549685W.....	201
1544970-1.....	152	1546329.....	223	1548320X.....	267	1549688.....	247
1544975.....	190	1546334P.....	185	1548338.....	286	1549689.....	19
1544987.....	201	1546335.....	248	1548340.....	286	1549705.....	201
1545032.....	188	1546341P.....	185	1548341.....	286	1549706.....	186, 187, 188
1545041.....	212	1546371.....	201	1548342.....	286	1549708.....	284
1545042.....	212	1546378.....	183	1548344.....	286	1549748.....	175
1545043.....	212	1546522.....	157	1548356.....	190	1549784.....	231, 234
1545072.....	152	1546523.....	216	1548411.....	212	1550027.....	234
1545092.....	56	1546533.....	20	1548446.....	203	1550079.....	212
1545112.....	268	1546599.....	33	1548464.....	174	1550080.....	212
1545112X.....	267	1546601.....	220	1548467P.....	185	1550081.....	212
1545113.....	268	1546755A.....	18	1548474.....	92	1550084.....	187, 188
1545113X.....	267	1546755B.....	18	1548497X1.....	187	1550091.....	207
1545114.....	268	1546796.....	235	1548497X3.....	187	1550272.....	202
1545115X.....	267	1546798.....	207	1548497X15.....	189	1550279.....	203
1545116.....	268	1546828.....	176	1548497X18.....	189	1550286.....	203
1545116X.....	267	1546944.....	57	1548506.....	58	1550291.....	284
1545117.....	268	1546956.....	57	1548509.....	58	1550308.....	175
1545145.....	234	1547053.....	185	1548513.....	58	1550327.....	200
1545147.....	235	1547057.....	235	1548514.....	58	1550334.....	57
1545149.....	234	1547064.....	209	1548523.....	247	1550351X1.....	206
1545150.....	234	1547097.....	185	1548583.....	183	1550360.....	162

1550372X1	206	1551979	177	1552860P	90	1554440	220
1550373	204	1551986	163	1552861P	90	1554447	157
1550381	177	1551990	31	1552870P	90	1554448	157
1550386	157, 182	1551993	161	1552876	173	1554449	233
1550389	216	1551994	161	1552886	90	1554459	19
1550392	157	1551997	248	1552887	90	1554476	247
1550393	157	1552006	233, 235	1552923	218	1554477	247
1550399	175	1552007	233, 235	1552964	27	1554483	248
1550400	174	1552008	233, 235	1552976	28	1554491	31
1550400X1	175	1552031	189	1552983	28	1554492	31
1550412	176	1552044	251	1552984	28	1554524	189
1550433	182	1552055	189	1552993	242	1554534	189
1550434	157	1552056	189	1553000	243	1554534X	189
1550445	57	1552069	275	1553006	244	1554542	268
1550471	20	1552071	275	1553007	244	1554546	268
1550501	203	1552072	275	1553008	244	1554550	268
1550534	220, 224	1552073	275	1553015	242	1554561	31
1550544	233, 235	1552075	275	1553024	173	1554563	268
1550554	202	1552076	275	1553061	190	1554563X	267
1550556	200	1552077	275	1553103	275	1554565	268
1550572	220	1552078	275	1553125	27	1554620	268
1550591	162	1552079	275	1553132	224	1554622	172
1550592	162	1552080	275	1553159	159	1554667	152
1550616	209	1552082	275	1553160	159	1554674	172
1550620	157	1552084	275	1553181X1	206	1554678	212
1550637	162	1552085	275	1553199	208	1554685	177
1550646	179	1552086	275	1553208	260, 275	1554692	218
1550652	183	1552087	275	1553241	250, 316	1554698	158
1550654	183	1552088	259, 275	1553298	257	1554878	212
1550662	31	1552094	189	1553319	274, 275	1554880	212
1550678	175	1552096	255	1553343	249	1554884W	91
1550692P	90	1552104	27	1553352	271	1554885W	91
1550693P	90	1552106	162	1553371	286	1554893	27
1550696	185	1552108	286	1553372	286	1554895	28
1550703	172	1552125	212	1553382	243	1554930	189
1550705	185	1552127	186, 189	1553388	231, 235	1554932	189
1550725W	90	1552176	39	1553403	257	1554950	212
1550726W	90	1552177	39, 189	1553411	255	1554974	39, 189
1550744	176	1552178	39, 189	1553430	270	1554978	188, 209
1550747	190	1552181X	267	1553480	260	1554985	188
1550770	190	1552190	208	1553490	220	1554990	187, 188
1550774	156	1552212	175	1553539	200	1555053	177
1550789	204	1552221	175	1553565	159	1555074	189, 209
1550795	204	1552237	214	1553609	152	1555081	268
1550801	206	1552246P	185	1553636	200	1555082	268
1550816	185	1552255	187, 189	1553638	189	1555084	268
1550822	174	1552256	213	1553640	188	1555098-9W	90
1550844	185	1552292	220	1553644	182	1555103	160
1550904	274	1552301	163	1553703	261	1555105	27
1550908	274, 275	1552311	80, 82, 83, 84, 88	1553737	218, 233, 234, 242	1555125	32
1550921	39, 208	1552334	247	1553800	31	1555133	235
1550980	183	1552335	247	1553804	188	1555154P	90
1550997	176	1552343	213	1553878	175	1555179	189
1550998	176	1552360	222	1553904	165	1555189	32
1551067	258	1552366	188	1554004	262	1555190	32
1551173	239	1552397	156	1554042	287	1555200	234
1551174	174	1552400	57	1554074	231, 233, 234, 235	1555215	234
1551190	183	1552401	178	1554075	231, 232, 233, 235	1555217	234
1551190X	183	1552421	175	1554076	231, 232, 233, 235	1555236X1	206
1551199	57	1552456	39, 208	1554077	231, 232, 233, 235	1555237	207
1551240	174	1552487	190	1554118	39, 187, 189	1555257	218
1551242	168	1552494	177	1554137	235	1555280	39, 208
1551253	226	1552496	275	1554164	27	1555290	175
1551318	175	1552529	207	1554179	242	1555292	175
1551327	183	1552535	175	1554197	163	1555295	152
1551330	164	1552538	174	1554198	163	1555303	214
1551334	174	1552542	31	1554224	242	1555319	58
1551336	286	1552561	32	1554227	243	1555325	161
1551338	177	1552562	224	1554230	242	1555395	158
1551342	257	1552569	178	1554236	261	1555397	158
1551343	257	1552589	222	1554238	242	1555398	158
1551375	244	1552623	178	1554247	156	1555399	158
1551380	190	1552649	209	1554296	90	1555404	158
1551387	274, 275	1552709	204	1554297P	90	1555407	158
1551403	164	1552721	212	1554303	91	1555408	158
1551422	190	1552728	254	1554304W	91	1555409	158
1551446	163	1552738	57	1554305W	91	1555431	28
1551449	164	1552739	57	1554306P	90	1555447	165
1551495	161	1552759	207	1554307P	90	1555461	234
1551507	220	1552780	208	1554308	165	1555462	234
1551513	177	1552785	183	1554315	180	1555463	235
1551527	27	1552791	174	1554320	180	1555464	235
1551530	208	1552793	218	1554368	183	1555477	234
1551563	161	1552798	56	1554369	183	1555478	232, 234
1551564	161	1552811	218	1554379	260	1555482	190
1551596	216	1552815	56	1554380	260	1555484	190
1551869	164	1552817	56	1554403	91	1555486	190
1551930	208	1552824	217	1554431	172	1555502	203
1551977	174	1552829	28	1554436	172	1555503	202

1555504.....	203	1556999.....	156	1558182.....	248	1559267.....	56
1555506.....	203	1557002.....	176	1558183.....	255	1559268.....	56
1555510.....	219	1557002X1.....	176	1558194.....	161	1559299.....	212
1555511.....	219	1557015.....	173	1558200.....	133	1559366.....	158
1555512.....	219	1557111.....	28	1558202.....	133	1559379.....	19
1555513.....	219	1557113.....	28	1558203.....	208	1559401.....	172
1555528.....	28	1557213.....	173	1558210.....	217	1559409.....	209
1555529.....	27	1557226.....	200	1558221.....	207	1559481.....	265
1555534.....	201	1557227.....	200	1558222.....	207	1559482.....	265
1555547.....	201	1557249.....	268	1558226.....	184	1559515.....	258
1555550.....	133, 201	1557262.....	27	1558235.....	247	1559521.....	286
1555554.....	32	1557275.....	217	1558236.....	247	1559522.....	286
1555563.....	175	1557319.....	217	1558237.....	247	1559664.....	57
1555571.....	176	1557350.....	178	1558238.....	247	1559665.....	57
1555590.....	249	1557358.....	39	1558239.....	247	1559666.....	164
1555595.....	249	1557359.....	208	1558253.....	27	1559671.....	179
1555606.....	248	1557365.....	214	1558255.....	164	1559712.....	255
1555680.....	161	1557378.....	268	1558279.....	156	1559719.....	249
1555708.....	28	1557384.....	262	1558290.....	203	1559721.....	249
1555709.....	28	1557385.....	262	1558328.....	178	1559730.....	255
1555712X.....	267	1557388.....	262	1558331.....	161	1559735.....	249
1555713.....	164	1557390.....	217	1558334.....	175	1559745.....	189
1555720.....	176	1557400.....	251	1558335.....	175	1559758.....	268
1555731.....	217	1557447.....	217	1558337.....	207	1559758X.....	267
1555755.....	188	1557450.....	219	1558366.....	177	1559760.....	268
1555771.....	161	1557476.....	262	1558369.....	174	1559770.....	196
1555803.....	216	1557491.....	224	1558373.....	262	1559771.....	255
1555884.....	216	1557500.....	253	1558380R.....	249	1559774.....	32
1555910.....	189	1557504.....	248	1558469.....	174	1559778.....	257
1555917.....	187, 188	1557505.....	248	1558482.....	200	1559784.....	28
1555923.....	91	1557508P.....	185	1558502.....	250	1559787.....	28
1555924.....	91	1557509.....	264	1558503.....	250	1559789.....	218
1555925.....	91	1557510.....	248	1558504.....	250	1559795.....	207
1555929.....	183	1557511.....	248	1558505.....	250	1559797.....	207
1555934.....	183	1557512.....	248	1558507.....	251	1559798.....	207
1555947.....	180	1557513.....	248	1558508.....	250	1559799.....	207
1555957.....	173	1557538.....	208	1558509.....	250	1559954.....	247
1555964.....	173	1557543.....	249	1558510.....	250	1559977.....	200
1555981.....	57	1557546.....	253	1558511.....	250	1559983.....	28
1555982.....	190	1557547.....	253	1558516.....	250	1560018.....	57
1556038.....	27	1557568.....	200	1558517.....	250	1560091.....	212
1556051.....	258	1557569.....	200	1558526.....	250	1560103X1.....	255
1556108.....	32	1557571.....	152	1558527.....	250	1560127.....	219
1556138.....	157	1557579.....	152	1558528.....	207	1560244.....	263, 284
1556146.....	218	1557584.....	58	1558540.....	286	1560245.....	263, 284, 286
1556170.....	185	1557585.....	58	1558541.....	286	1560257.....	184
1556190.....	90	1557608.....	219	1558565.....	286	1560311.....	217
1556191.....	90	1557623.....	259	1558570.....	174	1560329.....	175
1556198.....	91	1557636.....	268	1558580.....	161	1560332.....	217
1556199.....	91	1557637.....	268	1558629.....	178	1560340.....	217
1556201.....	91	1557658.....	200	1558650.....	208	1560348.....	217
1556295.....	158	1557660.....	200	1558673.....	57	1560358.....	203
1556296.....	158	1557668.....	254	1558689.....	257	1560365.....	189
1556297.....	158	1557671.....	254	1558689X1.....	257	1560395.....	184
1556298.....	158	1557684.....	189	1558693.....	257	1560422.....	284, 285
1556299.....	158	1557686.....	189	1558697.....	188	1560426.....	284
1556300.....	158	1557692.....	161	1558697X.....	188	1560438.....	207
1556328.....	217	1557705.....	160	1558698.....	189	1560439X.....	268
1556333.....	217	1557723.....	200	1558701.....	187, 189	1560440.....	268
1556334.....	217	1557729.....	179	1558702.....	189	1560467.....	19
1556338.....	217	1557751.....	178	1558703.....	187	1560473.....	203
1556342.....	217	1557857.....	159	1558705.....	178	1560480.....	268
1556343.....	217	1557858.....	159	1558719.....	209	1560516W.....	39, 189
1556344.....	217	1557859.....	159	1558720.....	208	1560517W.....	39, 189
1556345.....	223	1557882.....	197	1558732.....	178	1560526.....	262
1556346.....	217	1557883.....	197	1558738.....	19	1560526-7.....	262
1556347.....	217	1557903R.....	249	1558772.....	189	1560527.....	262
1556350.....	217	1557910.....	255	1558777.....	212	1560614.....	185
1556351.....	217	1557956.....	178	1558783.....	189	1560614X1.....	185
1556383.....	217	1557957.....	178	1558806.....	217	1560643.....	224
1556424.....	217	1558002.....	207	1558834.....	189	1560677P.....	90
1556442.....	31	1558008.....	207	1558903.....	251	1560745.....	178
1556482.....	57	1558009.....	207	1558905.....	251	1560774W.....	90
1556483.....	57	1558010.....	207	1558925.....	173	1560774X1.....	90
1556534X.....	267	1558011.....	156	1558927.....	189	1560830.....	175
1556854.....	178	1558014.....	207	1558939.....	207	1560842.....	185
1556912.....	186	1558015.....	207	1558948.....	152	1560843.....	185
1556913.....	186	1558016.....	207	1558962.....	177	1560957.....	189
1556916.....	187	1558063.....	248	1558968.....	56	1560969.....	220
1556923.....	186	1558066.....	253	1558979.....	159	1561053.....	172
1556924.....	187	1558068.....	253	1558980.....	159	1561094.....	255
1556925.....	186	1558069.....	253	1558995.....	212	1561095.....	264
1556936.....	200	1558074.....	190	1559002.....	242	1561125.....	27
1556941.....	200	1558083.....	175	1559008.....	218	1561165.....	162
1556944.....	200	1558084.....	175	1559059.....	284	1561165X.....	162
1556947.....	200	1558124.....	255	1559148.....	219	1561166.....	156
1556952.....	207	1558126.....	255	1559180.....	219	1561167.....	162
1556953.....	178	1558137.....	56	1559195.....	202	1561169.....	162
1556995.....	152, 153	1558140.....	56	1559223.....	32	1561172.....	156

1561252.....	57	1563476.....	212	1564374.....	158	1564792.....	234
1561261.....	187	1563506.....	212	1564375.....	158	1564797.....	234
1561288.....	19	1563527.....	57	1564376.....	158	1564799.....	234
1561307.....	189	1563540.....	57	1564377.....	158	1564801.....	235
1561327.....	179	1563541.....	207	1564378.....	158	1564802.....	233
1561352.....	159	1563571.....	183	1564381.....	159	1564803.....	234
1561355.....	159	1563588.....	168	1564382.....	159	1564809.....	245
1561356.....	159	1563589.....	168	1564383.....	159	1564810.....	245
1561404.....	190	1563591.....	207	1564384.....	159	1564819.....	242
1561418.....	187, 189	1563626.....	216	1564386.....	157	1564822.....	57
1561425.....	186, 189	1563627.....	183	1564387.....	157	1564823.....	57
1561429.....	160	1563632.....	248	1564393.....	154	1564825.....	245
1561445.....	212	1563639.....	184	1564394.....	219	1564826.....	245
1561446.....	212	1563670.....	157	1564396.....	162	1564827.....	242, 243
1561465.....	160	1563714-5.....	168	1564397.....	162	1564830.....	244
1561481.....	257	1563727.....	216	1564409.....	153	1564831.....	244
1561482.....	257	1563745.....	168	1564412.....	219	1564855.....	158
1561483.....	257	1563804.....	168	1564413.....	158	1564859.....	152
1561484.....	257	1563826.....	217	1564414.....	159	1564861.....	160
1561485.....	257	1563827.....	217	1564415.....	159	1564863.....	160
1561493.....	200	1563833.....	216	1564416.....	159	1564864.....	154
1561543.....	212	1563876.....	175	1564417.....	159	1564868.....	168
1561544.....	212	1563877.....	175	1564418.....	159	1564870.....	160
1561611.....	255	1563902.....	179	1564419.....	154, 160	1564871.....	163
1561633.....	185	1563904.....	177	1564420.....	158	1564876.....	152, 154
1561664.....	268	1563906.....	177	1564421.....	158	1564879.....	154
1561666.....	268	1563937.....	161	1564423.....	158	1564897.....	204
1561724.....	177	1563955.....	182	1564424.....	158	1564967.....	175
1561741.....	133, 201	1563956.....	182	1564425.....	158	1564983.....	183
1561767.....	261	1563963.....	157	1564435.....	152	1565001.....	178
1561769.....	261	1563982.....	162	1564442.....	154	1565042.....	159
1561778.....	260	1563987.....	154	1564446.....	158	1565043.....	159
1561779.....	260	1564000.....	226	1564448.....	152, 154	1565044.....	159
1561783.....	263, 287	1564026.....	154, 160	1564452.....	159	1565053.....	212
1561790.....	251	1564027.....	154, 160	1564454.....	158	1565073.....	159
1561840.....	218	1564031.....	161	1564455.....	158	1565074.....	159
1561842.....	177	1564044.....	154	1564456.....	158	1565075.....	159
1561930.....	208, 209	1564052.....	156	1564457.....	158	1565076.....	159
1561959.....	234	1564054.....	154, 156	1564459.....	184	1565099.....	159
1561960.....	235	1564055.....	154, 156	1564474.....	159	1565100.....	159
1561961.....	235	1564061.....	154	1564476.....	159	1565101.....	159
1562151.....	189	1564064.....	154, 185	1564480.....	159	1565102.....	159
1562249.....	213	1564065.....	185	1564482.....	159	1565135.....	203
1562279.....	233	1564066.....	154, 185	1564484.....	159	1565138.....	203
1562284.....	233	1564075.....	163	1564488.....	161	1565140.....	275
1562329.....	174	1564080.....	154, 164	1564496.....	162	1565148.....	208
1562340P.....	90	1564084.....	154, 164	1564499.....	208	1565154.....	202
1562344.....	20	1564092.....	154	1564512.....	176	1565168.....	154, 160
1562350.....	235	1564094.....	157	1564513.....	176	1565170.....	178
1562351.....	234	1564099.....	157	1564521.....	157	1565175.....	179
1562365.....	161	1564103.....	162	1564522.....	157	1565176.....	216
1562390.....	284, 287	1564106.....	162	1564526.....	157	1565184.....	219
1562419.....	284	1564114.....	154, 202	1564550.....	174	1565186.....	219
1562421.....	263, 284, 287	1564132.....	177	1564574.....	175	1565187.....	219
1562422.....	284	1564157.....	162	1564577.....	175	1565193.....	207
1562423.....	284	1564187.....	154, 160	1564580.....	174	1565194.....	209
1562424.....	284, 287	1564188.....	154, 160	1564614.....	174	1565206.....	216
1562434.....	284, 287	1564204.....	160	1564648.....	204	1565264.....	200
1562439.....	286	1564207.....	216	1564651.....	173	1565285.....	177
1562441.....	286	1564208.....	161	1564652.....	203	1565288.....	207
1562443.....	286	1564213.....	156	1564653.....	203	1565290.....	202
1562444.....	286	1564215.....	154	1564662.....	203	1565324.....	223
1562457.....	251	1564217.....	156	1564676.....	203	1565325.....	223
1562522.....	214	1564219.....	154, 156	1564695.....	185	1565336.....	154
1562571.....	28	1564226.....	154, 184	1564696.....	152	1565352.....	57
1562580W.....	91	1564228.....	154, 184	1564698.....	152	1565384.....	190
1562589.....	28	1564233.....	164	1564701.....	152	1565385.....	190
1562590.....	28	1564250.....	154, 173	1564703.....	161	1565393.....	190
1562643.....	174	1564260.....	162	1564704.....	161	1565396.....	57
1562649.....	28	1564261.....	162	1564705.....	161	1565404.....	57
1562731.....	179	1564269.....	202	1564710.....	179	1565420.....	58
1562826.....	177	1564271.....	154, 202	1564729.....	179	1565429.....	190
1562826X.....	177	1564311.....	248	1564733.....	161	1565430.....	190
1562868W.....	91	1564336.....	154, 160	1564741.....	201	1565431.....	190
1562869W.....	91	1564350.....	158	1564749.....	174	1565432.....	190
1562889.....	234	1564351.....	158	1564750.....	174	1565441.....	57
1562890.....	234	1564352.....	158	1564751.....	222	1565484.....	185
1562901.....	247	1564353.....	158	1564753.....	220	1565485.....	190
1562953.....	190	1564354.....	158	1564763.....	222	1565518.....	220
1562955.....	190	1564356.....	158	1564772.....	179	1565520.....	219
1562992.....	173	1564357.....	158	1564776.....	57	1565576.....	209
1563072.....	58	1564358.....	158	1564778.....	173	1565577.....	208
1563073.....	58	1564359.....	158	1564781.....	234	1565609.....	185
1563206.....	286	1564360.....	158	1564782.....	234	1565650.....	174
1563218.....	8	1564362.....	162	1564783.....	234	1565702.....	168
1563292.....	284, 287	1564363.....	162	1564784.....	234	1565703.....	202
1563463.....	178	1564364.....	162	1564785.....	234	1565705.....	156
1563473.....	161	1564372.....	159	1564787.....	234	1565706.....	156
1563475.....	257	1564373.....	159	1564791.....	234	1565707.....	152

1565709.....	152, 154	1657107.....	133	1689384.....	260, 279, 281, 282	1694783.....	247
1565711.....	162	1657110.....	133	1689389.....	281, 283	1694871.....	220
1565712.....	162	1657223.....	146	1689408.....	260, 279, 282	1694897.....	251
1565713.....	162	1657233.....	146	1689414.....	260	1694898.....	272, 273
1565714.....	162	1657260.....	146	1689500.....	28	1694984.....	251
1565720.....	157	1657598.....	146	1689566.....	28	1694991.....	251
1565723.....	160	1657615.....	49	1689567.....	212	1695105X1.....	206
1565731.....	202	1657673.....	50	1689569.....	212	1695129X1.....	206
1565732.....	202	1657751.....	197	1689678.....	174	1695368.....	91
1565757.....	159	1657800.....	146	1690121.....	251	1695369.....	91
1565760.....	159	1657850.....	146	1690124.....	266	1695407.....	91
1565777X1.....	31	1657851.....	146	1690219.....	266, 284	1695417.....	186
1565906.....	190	1657852.....	146	1690409.....	265	1695442.....	186, 187, 189
1565916.....	219	1657853.....	146	1690462.....	216	1695541.....	220
1565987.....	244	1657854.....	146	1690922.....	177	1695660.....	260
1654009.....	145	1657855.....	146	1691062.....	177	1695663.....	282
1654013.....	145	1657856.....	146	1691084.....	160	1695664.....	281, 282
1654075.....	211	1685100X.....	267	1691096.....	281, 283	1695704.....	260
1654081.....	197	1685104X.....	267	1691098.....	283	1695716X.....	267
1654115W.....	22	1685189X.....	267	1691099.....	281, 283	1695717X.....	267
1654125.....	182	1685204.....	177	1691100.....	281, 283	1695724X.....	267
1654135.....	89	1685379.....	212	1691101.....	281, 283	1695725X.....	267
1654286W.....	22	1685410.....	264, 287	1691108.....	251	1695854.....	269
1654396.....	40	1685551.....	263	1691111.....	281	1695995.....	185
1654662.....	211	1685564.....	284	1691112.....	281, 283	1696278.....	282
1654663.....	210	1685600.....	173	1691609X.....	267	1696293.....	282
1655024.....	197	1685602.....	153	1691610X.....	267	1696306.....	212
1655025.....	146	1685683.....	183	1691696.....	183	1696307.....	212
1655217.....	146	1685689.....	183	1691701.....	209	1696382X.....	267
1655226.....	259	1685691P.....	185	1691703.....	186	1696383X.....	267
1655229.....	259	1685777.....	157	1691761.....	265	1696462.....	185
1655242.....	146	1685847.....	213	1691762.....	265	1696518.....	281
1655243.....	146	1685848P.....	195	1691942.....	263	1696523.....	249
1655278X61.....	51	1685853.....	58	1691965.....	249	1696542.....	28
1655283.....	51	1685860.....	279	1692002.....	287	1696563.....	282
1655286.....	51	1685861.....	279	1692059P.....	91	1696572.....	212
1655287.....	51	1685869.....	264	1692061.....	152	1696576.....	177
1655290.....	55	1685892.....	209	1692062.....	152	1696606.....	282
1655291.....	55	1685901.....	266	1692116.....	184	1696607.....	282
1655294.....	51, 55	1685902.....	266	1692121.....	57	1696610.....	282
1655301.....	146	1685908.....	266	1692223.....	168, 216	1696611.....	282
1655314.....	59, 84	1686005.....	263	1692246P.....	90	1696791.....	259
1655316W.....	51	1686060.....	217	1692247P.....	91	1696822.....	216
1655324.....	32	1686080.....	196	1692249.....	260	1696852.....	255
1655326X1.....	89	1686084.....	196	1692256.....	247	1696854.....	255
1655327X1.....	89	1686089.....	28	1692284.....	220	1696855.....	255
1655389.....	51	1686096.....	28	1692287.....	216	1696862.....	282
1655392.....	193	1686126.....	168, 216	1692317.....	212	1696863.....	282
1655438X1.....	30	1686176.....	251	1692318.....	212	1696946.....	258, 282
1655461P.....	146	1686179.....	281, 283	1692335.....	212	1697013.....	251
1655512.....	34, 45	1686180.....	281, 283	1692378.....	185	1697036.....	282
1655546W.....	22	1686260.....	219	1692449X2.....	19	1697037.....	282
1655549.....	51, 59	1686958.....	255	1692450X2.....	19	1697128.....	156
1655549X1.....	59, 84	1687069.....	265	1692469.....	30	1697201.....	282
1655673.....	146	1687083.....	265	1692475.....	216	1697206X.....	267
1655681.....	146	1687115.....	153	1692580.....	281	1697270X.....	267
1655734.....	42	1687116.....	220	1692592.....	281, 282	1697340.....	180
1655783.....	182	1687216.....	254	1692593.....	281, 282	1697581.....	265
1655898.....	22	1687216-7.....	254	1692668.....	31	1700928.....	183
1656004.....	146	1687253.....	265	1692671.....	177	1701186.....	247
1656005.....	146	1687347.....	216	1692672.....	177	1702181.....	262
1656011.....	146	1687471.....	266	1692762.....	186, 187, 189	1702280.....	262
1656012.....	146	1687598X.....	267	1692797.....	216	1750144.....	41
1656019.....	146	1687673X.....	267	1692875.....	271, 279, 281, 282	1750235.....	131
1656026.....	146	1687675.....	165	1692901.....	28	1750333.....	18
1656027.....	146	1687678X.....	267	1692931.....	209	1750663.....	193
1656068.....	146	1687684X.....	267	1693031.....	216	1750664.....	193
1656087.....	146	1687687.....	216	1693302X.....	267	6484039.....	173
1656088.....	146	1687692.....	265	1693350.....	212	6484102.....	266
1656113.....	196	1687701X.....	267	1693361X.....	267	6484191.....	204
1656119.....	146	1687705X.....	267	1693393.....	156	6484249.....	203
1656120.....	146	1688084.....	281, 283	1693608.....	182	6484470.....	196
1656121.....	146	1688088.....	281, 283	1693788.....	91	6484685.....	200
1656164X1.....	34	1688089.....	281, 283	1693789.....	91		
1656262.....	193	1688095.....	220	1693847.....	212		
1656312.....	133	1688124P.....	145	1693853X.....	267		
1656319.....	211	1688191.....	57	1693964.....	254		
1656326.....	146	1688219.....	175	1694197.....	177		
1656327.....	146	1688220.....	249	1694205.....	185		
1656328.....	146	1688221.....	249	1694264.....	212		
1656350.....	89	1688227.....	281, 282	1694266.....	212		
1656351.....	89	1688284.....	254	1694267.....	212		
1656356.....	197	1688365.....	28	1694301.....	58		
1656357.....	197	1688762.....	263	1694306.....	58		
1656376.....	42	1688944.....	216	1694315.....	58		
1656379X1.....	34	1689046.....	263	1694331.....	28		
1657064.....	90	1689073.....	271, 281, 283	1694369.....	177		
1657096.....	211	1689299.....	249	1694440.....	91		
1657101.....	54	1689309.....	175	1694605.....	57		
1657102.....	54	1689336.....	247	1694611.....	281		

A

A-Arm

Bushings, Pins, & Bumpers269-270

Absorber

Shock265

Accelerator

Cover & Pads178

Accessory

Guides: Avanti, Hawk, Lark301

Adapter

Carburetor to Air Cleaner174-177

Oil Breather161

Rear Window Crank (Wagonaire).....47

Tailgate Window Regulator Control137

Adhesive

Rubber.....60

Additive

ZDDP Oil160

Adjuster

Knobs for Seat.....26

Adjusting Arm

Alternators207

Clutch220

Generator206

Air

Cleaner177

Conditioner Related Parts190

Conditioner Belts58

Conditioner Knobs.....39

Conditioner Pulley57

Conditioner Switch209

Deflectors138-140

Filter177

Vent Seals60

Ventilator Kit184

Album

For Your Studebaker Pictures.....305

Alternator

Adjusting Arm207

Belt58

Parts.....207

Rebuilt207

Tag207

AMC

.....316

Antennas

& Related Parts32

Anti-Creep

Solenoid Switches209

Apparel

.....311-315

Apron

Fender Truck146

Fender Car139

Inner Fender Splash142

Rear Quarter Roof.....142

Arm

Generator Adjusting206

Pitman260

Rest Pad.....34

Steering.....258

Windshield Wiper54

Armature/Armatures

Generator206

Starter Motor204

Windshield Wiper Motors211

Ashtray

Catalog Section.....41

Padded Covers (Lark)33

Automatic

Transmission236-241

Axle

Front & Rear279-285

Parts.....263-264

Twin Traction286

B

Baby

Romper.....314

Back

Glass55

Glass (Sliding) Kit for 1960-64 Pickup.....51

Glass Weatherseals59

Back Up

Light Bodies, Retainers, & Bezels195

Light Lens & Body Gaskets & Seals.....198

Light Lenses196-197

Light Switch Bracket, 4 Speed208

Light Switches208

Baffle

Seal Radiator, 1956-64 C&K.....182

Seal Staples for182

Bands

Automatic Transmission Section236-241

Bar

Front Stabilizer262

Glasses310

Horn214

Stabilizer Front & Rear262

Battery

Brackets, Hold Downs, Mats,
Reinforcements & Related Parts.....213

Decals9

Bearing

and Bushings, Starter Motor.....205

Camshaft.....157

Camshaft, Main, & Rod (Sets).....158

Caps, Main Bearing.....158

Clutch Release220

Interior Seat (1962-66)26

King Pin.....271

Main Drive232

Main Shaft232

Overdrive Shaft222, 231, 232

Pinion/Differential264

Rear Main Seals (Engine).....158

Retainer Kit, Clutch Shaft.....220

Starter205

Transmission Standard, Front & Rear223

Bell

-Crank Steering260

Housing Parts.....220

Belts

Buckle.....311

Catalog Section (Air Conditioning, Fan,
Generator & Alternator58

Seat (Belt).....26

Bezel

Air Conditioner190

Back-Up Bezel.....195

Headlight193-195

Tail Light194

Ignition Switch201

Blade

Air Conditioner Evaporator Motor, Fan ...	190
Fan	184
Heater Blower Motor, Fan.....	189-190
Windshield Wiper	54

Block

Engine	168
Engine Filler, front.....	168
Junction	213

Birthday

Card.....	297
-----------	-----

Body

Catalog Section.....	85-146
Fiberglass.....	289
Manuals.....	12, 14-17
Panels (Sheet Metal Section).....	138-146
Small Parts Kits.....	128-130

Bolt

Bumper.....	90
Crankshaft.....	157
Piston Pinch	158
Spare Tire Hold Down.....	20
U-Bolt, Leaf Spring.....	268, 286

Books

.....	292-293
-------	---------

Booster

Hydrovac Power Brakes	249
-----------------------------	-----

Boot

Firewall.....	250
Floor Shifter.....	218
Throttle or Gas Pedal	178

Box

Steering & Related Parts.....	259
Assembly, Steering Linkage 57-64 Hawk.....	274

Brackets

Alternator Mounting.....	207
Back Up Switch	208
Battery.....	213
Bumper.....	90-91
Engine to Frame	168
Evaporator (A/C).....	190
Ignition Cable	201
License Plate.....	91
Mirror.....	29
Rear Quarter Window.....	53
Tail Light to Frame Trucks	195
Throttle Return Spring.....	179

Brake/Brakes

Boosters, Hydrovacs & Related Parts	249
Caliper	248
Catalog Section.....	246-255
Decals	9
Disc & Related Parts	253-254
Drums & Related Parts.....	251-259
Emergency Cables & Related Parts.....	247-248
Fluid, Silicone	248
Hill Holder Kits.....	250
Hole Plug, Adjusting (Rubber)	250
Hoses & Hose Copper Washers	249-250
Master Cylinders & Related Parts	255
Light Switches	208
Parking	247-248
Pipe Clip, to Frame or Axle.....	253
Pedal Bushings, Pads & Seals	247
Power Booster & Related Parts.....	249
Self-Adjuster Parts	250
Shoes & Related Parts	255
Springs	251-252
Wheel Cylinders & Repair Kits	253-254

Brightworks

Packages.....	118-128
---------------	---------

Brochures

Original & Reprinted.....	298-299
---------------------------	---------

Brushes

Alternator.....	207
Generator	206
Starter	204-205

Bucket

Headlight.....	193
----------------	-----

Bulbs

6 & 12 Volt	197
Headlight	193

Bumper

A-Arm.....	270
Bars, Brackets, Extensions, Guards & Related Parts	90-91
Bolts	90
Glove Box Door	40
Stickers.....	307

Bushing

A-Arm (Front Suspension).....	270
Bell Housing (Clutch).....	220
Brake & Clutch Pedal	247
Clutch	222

King Pin.....	271
Lower Steering Column, Avanti	258
Spring, Front & Rear.....	269
Starter	205
Supercharger Mounting Brackets.....	178

C

Cable

Emergency Brake & Related Parts..	247-248
Heater Control.....	186-189
Hood Release.....	88
Ignition.....	201
Overdrive Lockout	226
Speedometer.....	27
Trunk Release (Avanti)	134
Turn Signal & Parking.....	195
Windshield Wiper	210-211

Caliper

Front Disc Brake.....	253
-----------------------	-----

Camshafts

Bearing Sets, Rear Hole Plugs, Timing Gears and Related Parts.....	157
---	-----

Canceler

Turn Signal	208
-------------------	-----

Cap

Baseball, Beanie (Stocking).....	312-315
Distributor	202
Dust or Front Wheel Grease.....	264
Gas Tank Filler	172
Hub & Wheel Covers.....	19
Oil Breather	161
Radiator.....	183
Tire Valve Stem Set.....	305
Windshield Washer Bag	56

Car

Cover.....	92
Identification Charts	148-151

Carburetor

NOS, Rebuilt & Related Parts	174-175
------------------------------------	---------

Cards

Christmas & Birthday.....	296-297
Glove Box Information.....	298
Postcards	299

Carpet

Protectors.....	36-37
Sets & Extra Yardage.....	35

Chair	
Folding.....	315
Chassis	
Parts Books or Manuals.....	12, 14-17
Wiring Harnesses, Front & Rear.....	212
Check	
Door.....	132
Choke	
Housing, Pipe, Heater Tube, Thermostats ...	179
Children's	
Apparel.....	311-312, 314
Christmas	
Cards.....	296-297
Ornaments.....	311
Wrapping Paper.....	305
Chrome	
Parts (throughout catalog- see part by type)	
Cigarette	
Lighter Related Parts.....	41
Clamp	
Heater Duct.....	187
Hose, Radiator & Heater.....	183
Manifold (Intake).....	164
Tire.....	20
Cleaner	
Cooling System.....	182
Clip(s)	
Back Glass Moulding.....	55
Brake Hose.....	249
Brake Pipe.....	253
Brake Shoe Retainer.....	255
Dash Retaining.....	33
Door & Window Handle (Interior).....	43
Door Lock Retainer.....	132
Door Panel.....	38
Firewall Liner.....	42
Glove Box.....	40
Headliner.....	38
Hood Prop.....	89
Hubcab Retainer.....	19
Moulding Kits.....	93-100
Moulding & Rocker Panel.....	141
Rear Shelf Retainer.....	29
Roll Bar Cover (Avanti).....	38
Sunvisor.....	29

Trunk Lock Retainer.....	134
Wheel Well Moulding (C&K).....	20
Window Roller.....	47
Window Run.....	62
Wiring Harness.....	212

Cluster

Gauges.....	28
-------------	----

Clubs

How to Join.....	7
------------------	---

Clutch

Catalog Section.....	219-224
Pedal Pads.....	247

Coil

Ignition & Resistors.....	200
Springs.....	268

Collectible

Automobile Magazines.....	298
Brochures & Postcards.....	298-301
Models & Related Items.....	308

Color/Colors

Avanti Vinyl Dye.....	34
Floor Cover/Mats.....	35-36
Replacement Windlace.....	38
Samples, Avanti Upholstery & Paint.....	301
Seat Belts.....	26

Column

Lower Bushing, Avanti.....	258
Seals (Steering).....	259
Shifter Enclosure & Knobs.....	217-218

Compressor

Air Conditioner & Related Parts.....	190
--------------------------------------	-----

Condensers

Air Conditioner.....	190
Distributor Part.....	203

Connecting

Rods.....	157
-----------	-----

Console

Ashtray & Retainer.....	41
Glove Box Liners, Avanti.....	40
Heater Control Plate.....	183
Plate, Lid Handle & End Cap Avanti.....	29

Control

Knobs and Handles.....	31, 39
Valve (Flight-O-Matic Trans.).....	244
Valve (Power Steering Seal Kit).....	258
Valve (Rebuilt & New, Heater).....	186

Converters

Torque.....	217
-------------	-----

Convertible

Motor.....	86
Pump Seal Kit.....	87

Cooling

Air Conditioning.....	190
Catalog Section.....	182-190
Cleaner.....	182

Core

Charges.....	5
Heater.....	186
Speedometer Cable.....	27

Courtesy

Light Lens.....	42
Light Switches.....	209

Cover

Accelerator or Gas Pedal (Accessory) ...	178
Car & Truck.....	92
Dash Mats, Pads, Protectors.....	34
Floor.....	35-36
Manifold Heater Valve (Cover) Gaskets .	164
Pre-War Manifold Heater Valve (Cover)	
Gaskets.....	165
Roll Bar (Avanti).....	38
Seat (Avanti).....	35
Shifter (Floor).....	218
Timing (Cover) - Engine.....	156
Trailer-Hitch Ball.....	305
Trunk & Spare Tire.....	37
Valve or Rocker (& Related Parts).....	162
Wheel.....	20-21

Cowl

& Dash Area Panels.....	145
Drain Kit.....	93
Drain Tube & Strap.....	92
Seals.....	60

Crankshaft

Timing Gears, & Related Parts.....	156-157
------------------------------------	---------

Cushion

Bumper Pads.....	91
Damper (Crankshaft).....	156
Driveshaft Support.....	266

Cylinder

Block (Engine).....	168
Head & Gaskets.....	152
Lift (Cylinder) for Convertible Top.....	86
Master (Cylinders) & Rebuild Kits.....	255
Wheel (Cylinders) & Rebuild Kits.....	254

D

Damper

Cushion & Vibration (Crankshaft).....	156
---------------------------------------	-----

Dash

Catalog Section.....	30-34
----------------------	-------

Decals

Decal Section.....	8-10
--------------------	------

Deflector

Air (Sheet Metal).....	138-140
Exhaust.....	164
Gravel, Rear.....	141-142

Defroster

Switches.....	209
Related Parts.....	187-188

Delco

Tags for Distributor and Generators (Delco).	207
---	-----

DG

Transmissions.....	236-239
--------------------	---------

Dial

Radio.....	31
Shifter Indicator, auto. trans.....	217-218

Differential

& Rear Bearings.....	266
----------------------	-----

Dimmer

Switch, Headlight.....	209
------------------------	-----

Dipstick

Engine Oil.....	161
-----------------	-----

Disc

Brake Pipes & Rotors.....	253
Clutch.....	219-220
Rebuild Kits.....	253

Discounts

Available.....	6
----------------	---

Distributor

And Related Parts.....	202-203
------------------------	---------

Door

Arm Rest.....	34
Assemblies & Skins (Sheet Metal) ..	142-143
Check.....	132
Child Safety Lock.....	132
Gas Filler & Related Parts.....	172
Glove Box.....	40
Handles & Related Parts.....	43, 131-132
Latches/Locks.....	132-133
Opener (remote).....	132
Panels (Cardboard).....	38
Panels (Sheet Metal).....	143-144
Skins (4 door).....	142

Dowel

Pins, Cylinder - Head to Block.....	152
-------------------------------------	-----

Drag Link

Reach Rod, Assembly and Ends.....	260
-----------------------------------	-----

Drain

Plug, Oil Pan.....	160
Tube with Strap (Cowl).....	92

Dress-Up

Engine Parts.....	162
-------------------	-----

Drier Tank

Air Conditioning.....	190
-----------------------	-----

Drip

Roof Rail, Joiner.....	87
------------------------	----

Drive

Arm for Windshield Wipers.....	210
End Bearing (Alternator).....	207
Housing Bushings (Bendix).....	205
Starter.....	204

Driveshaft

Center Support Kits.....	278
U-Joint, Center Support Bearings, Related Parts & Kits.....	278

Drums

Brakes & Related Parts.....	251
Rebuild Kits.....	252

Duct

Heater/Defroster.....	187
-----------------------	-----

Dum Dum

Body Sealer.....	90
------------------	----

Dye

Dash.....	34
Vinyl.....	34

E

Elbow

Heater Hose.....	184
Supercharger to Air Cleaner.....	176

Electrical

Catalog Section.....	192-214
----------------------	---------

Emblems

and Ornaments.....	22-25
Kits.....	112-118

Embroidered

Patches.....	309
--------------	-----

Emergency

Brake Warning Light & Switch.....	208
Brake Parts.....	247-255

Enamel

Engine Paint.....	168
-------------------	-----

End

Cap for Console.....	29
Tie Rods.....	261

Engine

Blocks & Brackets.....	168
Catalog Section.....	156-170
Dress-up Parts.....	162
High Temperature Enamel.....	168
Identification Charts.....	148-151
Overhaul Gasket Sets.....	166-167
Overhaul Kits.....	169-170

Escutcheon

Dash Knobs.....	39
Door & Window.....	43
Rear Quarter Window.....	54
Wiper Pivot.....	210

Evaporator

Motor.....	190
------------	-----

Exchanges

& Refund Information.....	5
---------------------------	---

Exhaust

Deflectors & Related Manifold Parts	
.....	164-165
Valves & Seats	162

Extension

Bumper.....	90
-------------	-----------

F

Faceplate

Ashtray	41
Heater Control.....	183
Radio	31
Speedometer.....	27
Tachometer.....	28

Facing

Clutch Disc	220
-------------------	------------

Fan

Air Conditioner Evaporator Motor	190
Belts	58
Blades, Clutches, & Shrouds.....	184-185
Decal	9
Heater Blower Motors.....	187-189

Fender

Apron (Front)	142
Corner Seal (Front).....	141
Emblems & Ornaments	21-22
Fin (Rear)	141
Front & Related Parts.....	138-140
Rear.....	140-142
Skirts	141
Shims, Body	61
Spear Assembly, Lens & Seals	197
Welt	141

Fiberglass

Catalog Section.....	289
----------------------	------------

Fillers

Oil Tubes	161
Hood (Grill Side Mouldings, 1962 Hawk) ..	89
Seam (Body).....	141

Filter

Air Elements	177
Fuel	173
Oil.....	161

Fin

Rear Fender	141
Scripts, Emblems & Ornaments	21-25

Firewall

Boot.....	250
Grommet	92
Liner & Clips	42
Sheet Metal Panel	141

Flexible

Brake Hose.....	249
Hoses (Fuel Pump).....	173
Hoses (Oil)	161

Flight-O-Matic

Automatic Transmission	
1956-1966	242-245

Flipper

Above Door	131
------------------	------------

Floor

Carpet, Mats & Cover (Rubber).....	35-36
Shifter Parts	217

Flywheel

.....	153
-------	------------

Frame

Cross Members.....	216
Rail Plates	216
Rear Quarter Window Assemblies	53
Saddle (Avanti Rear)	216
To Body Pads	145
Vent Windows.....	49

Freeze

Brass Plug.....	182
-----------------	------------

Front

Axle	279-283
Coil Springs & Related Parts.....	268
End (Sheet Metal).....	138-140
Fender (Avanti).....	289
Kick Panel	38
Leaf Spring Related Parts	268-269
Stabilizer Bar	262
Suspension Kits.....	269
Transmission Bearings (Standard)	223
Wheel Bearings & Related Parts.....	264

Fuel

Catalog Section	172-180
Filler Pipes.....	172
Pump & Related Parts.....	173
Tank.....	180
Tank Sending Units	173

G

Gas (Also see Fuel)

Caps	172
Decals	8
Filler Parts	172
Gauges.....	28
Pedals & Related Parts	178
Pedal Push Rods.....	177
Tank.....	180
Tank Filler Grommets	172

Gasket

Cooling, Thermostat Housing.....	185
Door Handle (Exterior - Avanti)	131
Engine	163-165
Exhaust Flange	164
Fuel System.....	173
Heater & Heater Core Housing	186
Lens.....	198
Manifold.....	168
McKinnon (1965-66 Car).....	154
Oil Pan.....	160
Short Block.....	154
Silicone Sealer	156
Valve Lifter Cover	162
Water Pump.....	184

Gauges

and Related Parts.....	27-28
------------------------	--------------

Gears

Flywheel Ring.....	220
Oil Pump.....	160
Rear Axle	284-287
Steering.....	272-275
Timing (Camshaft).....	157
Transmission	220

Generator

Catalog Section.....	206-207
Rebuilt, Rebuild Kits & Related Parts.....	206

Glass/Glasses

Back, Tailgate & Related Parts.....	52-53
Catalog Section.....	47-56
Door & Related Hardware	47-50
Drinking	310
For Instruments	30
Sun with Studebaker Logo	314

Glove Box

AMC	316
Bumpers, Liners & Related Parts.....	40

Information Cards.....	298
Keys & Locks.....	40
Padded Covers.....	34
Gravel	
Deflectors, Rear.....	141
Shields.....	20
Grilles	
Catalog Section.....	89
Grommet	
Air Conditioner Hose.....	190
Bumper Bar.....	91
Door Lock (Anti-Rattle).....	43
Engine Rocker Cover Stud.....	162
Firewall.....	92
For Parking Brake Rod (Plastic).....	248
Gas Filler Neck, Bumper Bar, & Lighting.....	172
Headlight Cables.....	193
Heater.....	186
Power Window.....	211
Valve Stud Cover.....	162
Guard	
Bumper.....	91
Gas Filler.....	172
Gravel, Splash, Rear Fender.....	20, 139-141
Guide	
Accessories (Manual).....	301
Brake Self-Adjusting (Screw & Nut).....	250
Valve.....	163
Window, Door.....	47
H	
Handle	
Exterior Door.....	131
Interior Door.....	43
Tailgate.....	134
Vent Window.....	50-51
Window Crank.....	47
Hardware	
Sill Plate.....	37
Vent Window.....	50-51
Harness	
Wiring.....	212
Hat	
Baseball.....	314-315
Beanie.....	313
Denim.....	312
Pins.....	310

Head	
Cylinder.....	152
Cylinder Rebuild Kits.....	163
Lights, Rims, Rings & Related Parts.....	192-193
Liners, Kits, Retainers & Clips.....	38
Seals & Gaskets.....	163-165
Header	
Cast Iron.....	164
Heat/Heater	
Cores, Seals, Hoses, Control Valves, Motors, & Other Related Parts.....	185-189
Defroster Parts.....	187-189
Riser Valves, Kits & Related Parts.....	163
Shield for Fuel Pump.....	173
Switches.....	209
Hill Holder	
Valve Seal Kits.....	250
Hinge	
& Pins (Door).....	131-132
Convertible Top.....	86
Cover for Seat Hinge.....	26
Gas Door (Filler).....	172
Hood.....	88
Rear Quarter Window (Coupe & Avanti).....	53
Tailgate	
Station Wagon.....	135-136
Truck.....	145
Hood	
& Panels.....	143
Catalog Section of Related Parts (Bumpers, Insulators, Hinges, Locks).....	88-89
Ornaments & Emblems.....	21-22
Horn	
Buttons & Related Parts.....	33
Button Switches.....	209
Electrical Related Parts.....	214
Hose	
Air Conditioner.....	190
Brake.....	249
Filler (Gas).....	172
Flexible (Oil).....	161
Heater.....	187
Power Steering.....	257
Radiator & Related Parts.....	183
Housing	
Bell Related Parts.....	220

Choke, Carburator.....	179
Evaporator Blower, A/C.....	190
Heater.....	186-189
Parking Light.....	195
Pieces, Air Vent.....	184
Tail Light.....	194
Thermostat (Water Outlet).....	185
Trunk Lock.....	133
Hubcab	
& Wheel Covers.....	19
Clips.....	20
Restoration Kit.....	20
Hydrovac	
Hoses & Related Parts.....	249
Hudson	316
I	
Idler	
Arm Steering.....	258
Ignition	
Catalog Section.....	201-202
Key/Locks.....	133, 201
Indicator	
Automatic Shift.....	218
Insert	
Arm Rest (Avanti).....	26
Emblem & Hood Ornament.....	21-25
Hood.....	22-23
Mirror (Exterior).....	18
Steering Wheel (Avanti).....	258
Instruction	
for Avanti AM-FM Radio.....	31, 300
Jacks, Avanti.....	300
Ordering.....	4-6
Returns, Exchanges & Refunds.....	5
Shipping.....	4-5
Weatherseal Installation.....	59
Instrument	
Gauges.....	28
Surrounds.....	28
Light Switches.....	209
Insulator	
Drink.....	310
Firewall.....	42
Hood.....	88
Transmission Shift Levers.....	218

Intake

Manifold.....	164
Manifold Gaskets.....	164
Valves.....	162

Interior

Catalog Section.....	26-46
Handles.....	43, 47
Kits.....	44-46
Lamp Switch.....	209

J

Jack

and Related Parts.....	20
------------------------	----

Jewelry

Studebaker.....	312
-----------------	-----

Junction

Block for Headlights & Horn Cables.....	213
---	-----

K

Keys

Door.....	133
Glove Box.....	40
Ignition.....	133, 201
Locks.....	133
Trunk.....	133-134

Kick

Down Switches (Overdrive).....	226
Panel, Front.....	38

Kits

Air Vent Seal.....	60
Antenna.....	32
Convertible Pump Seal.....	87
Door & Window Handle.....	43
Drum Rebuild Kits.....	252
Flange Repair.....	164
Generator Overhaul.....	206
Heat Rebuild.....	165
Heat Riser.....	163
Interior.....	44-46
King Pin.....	271
Major Disc Brake.....	253
Major & Minor Rebuild.....	169-170
Motor Mount.....	153
Moulding Clip Kits.....	93-100
Special Disc Brake Rebuild Kits.....	252
Starter Rebuild.....	205
Special Drive Shaft.....	266
Special Front Suspension.....	269

Tune-Up.....	202
Wheel Restoration.....	20
Window Roller.....	47
Windshield Center Bar.....	60

King Pin

Bushings, Bearings & Kits.....	271
--------------------------------	-----

Knobs

Control, Turn Signal.....	39
Glove Box.....	40
Lighter Elements.....	41
Radio.....	31
Seat.....	26
Transmission Column Shifter.....	217
Turn Signal.....	39
Window.....	47

Knuckle

Steering.....	277-285
---------------	---------

L

Label

Switch Sets.....	209
------------------	-----

Lamp

Assembly (Head).....	195
Assembly (Tail).....	196
License.....	196
Parking/Turn Signal & Related Parts.....	195
Sockets & Cables.....	195

Lapel

Pins.....	310
-----------	-----

Latch/Latches

Door.....	131
Hood.....	88
Station Wagon.....	135-137
Trunk.....	134
Window Part.....	54

Leaf Spring

Cars & Trucks.....	267-268
Related Parts.....	267-268

Lens

Courtesy & Map.....	42
Gaskets.....	198
Glove Box.....	40
Kits.....	199
Parking, Tail, Back-Up, Turn Signal, License.....	196-197
Plastic Horn Button.....	33
Screw Kits.....	396

Lever

Clutch Release.....	220
Door Lock.....	43
Hood Lock Release.....	88
Trunk.....	134
Turn Signal.....	39, 208

License

Lamp Assemblies.....	196
Lens.....	196
Lens Seal.....	196
Plate Bracket.....	91
Plate Guard.....	91

Lift

Convertible Parts.....	86-87
------------------------	-------

Light

Back Up / Parking.....	195-197
Glove Box.....	40
Head.....	192-193
Housing.....	192-195
Knob.....	39
Running.....	195
Switches.....	208-209
Sunvisor.....	29
Tail.....	194-195

Lighter

Cigarette/Cigar.....	41
----------------------	----

Liner

Firewall.....	42
Glove Box.....	40
Head.....	38
Trunk.....	37

Linkage

Clutch.....	221-223
-------------	---------

Literature

Avanti.....	298-301
Studebaker Original.....	298-299

Location

Location.....	6-7
---------------	-----

Lock

Door (Signals & Kits).....	132-133
Glove Box.....	40
Hood.....	88
Out Cables & Overdrive Switches.....	226
Plate (Crankshaft).....	156
Trunk.....	133-134

M

Magazine

Collectible Automobile.....298

Main

Engine Bearing.....158

Manifold

Intake & Exhaust & Related Parts.....164

Manuals

Body and Chassis.....12

Catalog Section.....11-17

Other Makes.....316-317

Owner's.....13

Shop.....11

Map

For Main Office in to Hope to Warehouse in Shelbyville.....6

Light Lens.....38

Master

Cylinder (Brakes).....255

Mat

Battery.....213

Dash (Avanti).....33

Floor.....36

Trunk.....37

Membership

Information for Studebaker Related Clubs7

Mirrors

Exterior & Related Parts.....18

Interior & Related Parts.....29

Models

Cars & Trucks.....308

Monograph

In Depth Information & Statistics On Studebaker Cars & Trucks.....302

Motor

Convertible Top.....86

Evaporator Blower (A/C).....190

Heater/Defroster.....187

Mounts & Kits.....152-153

Power Window, Tailgate, & Windshield Wipers.....211

Moulding

Back Glass & Related Parts.....55

Catalog Section.....100-112

Clip Packages.....93-100

Dash.....34

Hood Fillers (1962 Hawk).....89

Wheel Well.....20

Mount

Motor.....152

Motor Mount Kits.....153

Mud

Guards or Splash Guards.....20

Muffler

.....165

Mug

Cylinder.....310

N

Nameplate

Heater Control.....183

Overhead Switch (Avanti).....42

Neck

-lace.....312

Tie.....315

Neutral Safety

Switches.....208

Neutralizer

Cooling System.....182

Nipple

Clutch Linkage.....222-223

Heater.....186

Nonviscous

Drive Fans.....185

Nut

Antenna.....32

Brake Adjusting (Screw & Guide).....250

Chrome Rocker Cover.....162

Ignition Shielding Acorn (1963-64 Avanti)200

License Bracket to Body.....91

Rear Axle.....263

Spare Tire Wing.....20

Vent Window Lower Pivot.....51

Wheel.....264

Windshield Wiper.....210

O

Oil

Additive (ZDDP).....160

Catalog Section.....160-161

Gauges.....28

Pan Gaskets.....160

Pan (Transmission).....239-240

Pressure Light Switch.....209

Related Decals.....8

Ordering

Instructions.....4-6

Other

Makes.....316-317

Ornaments

& Emblems.....22-25

Christmas.....311

Outlet

Water (Thermostat Housing).....185

Overdrive

Related Parts.....226-235

Transmission.....226-235

Wiring Harnesses.....212

Overhead

Switch Name Plate.....42

Owner's

Manuals.....13

P

Package

Brightworks.....118-130

Manuals.....14-17

Moulding Clip.....93-100

(Rear) Shelf Cover.....29

Packard

.....317

Pad

Arm Rest.....34

Bumper.....90-91

Clutch & Brake Pedal.....247

Dash.....34

Frame to Body.....145

Mouse.....308

Paint

Charts & Samples (Avanti).....301

Dash Pad.....34

Enamel Engine.....168

Interior Instrument Panel And Window Trim.....32

Vinyl Dye.....34

Wheel & Wheel Cover.....20

Pan(s)

Automatic Transmission & Related Parts	239-242
Engine Oil & Related Parts	160-161

Panels

Air Deflector	139-140
Car Trunk & Tailgate Areas	143-145
Deflector, Rear	140
Door, Rear & Front	139-140
Fiberglass	289
Front Kick	38
Front Nose (Sheet Metal)	138
Rear Quarter	142
Rear Wheelhouse (Sheet Metal)	142
Rocker & Sill	144
Roof & Hood (Sheet Metal)	143
Sheet Metal Catalog Section	138-146
Tailgate (Station Wagon)	144
Truck (Sheet Metal)	145-146

Parking

Light Housing & Related Parts	195-197
Linkage Related Parts (Auto. Trans.)	245

Parts

Manuals	11-17, 301
---------------	------------

Patch

Embroidered	309
-------------------	-----

Pedal

Gas	178
Pads, Clutch, & Brake	247

Pens

Ballpoint	309
-----------------	-----

Photo/Photos

Album	305
Factory	290-291
Posters	301

Pin

A-Arm (Front Suspension)	270
Dowel (Cylinder Head to Block)	152
Hat, Tie, Lapel	310
Hinge (Door)	132

Pinion

& Barrel (Starter - Bendix)	205
Bearings (Differential)	266
Gears (Speedometers)	27
Seals (Rear Axle)	263, 284-287
Transmission	231

Pipe

Auto Choke	179
Disc Brake	253
Exhaust & Tail	165
Flange Gaskets for Exhaust	164
Fuel Pump to Carburetor	174
Gas Tank Filler	172

Piston

Ring & Sets	159
-------------------	-----

Pitman

Arms	260
------------	-----

Pivot

Escutcheon Kits	210
Vent window	50-51
Windshield Wiper	210

Plaques

Dash	33
------------	----

Plates

Clutch Pressure	220
Console, Heater Control Lever, (Avanti)	183
Door Striker	132
Face, Radio	31
Frame Rail	216
Front Crankshaft & Related Parts	156
Horn	214
License	307
Name or Script	21-22
Shifter	217
Sill or Step	37
Starter (Center Bearing)	205

Plug

Brake Shoe Adjusting Hole	250
Camshaft Rear Hole	157
Clutch Linkage	222
Drain, Oil Pan	160
Drain, Rear Axle	284-287
Freeze	182
Grease	283-287
Spark	202
Steering Gear	272-275
Welch	279, 281

Points

Ignition	203
----------------	-----

Post

& Cam (Steering)	259, 272-275
Card	299
Center Pillar (Sheet Metal)	145
Door Hinge (Sheet Metal)	145

Posters

.....	301
-------	-----

Power

Brake Boosters & Related Parts	249
Hawk Script ("Power")	21
Shift Automatic Transmission	217
Steering Catalog Section	257-259
Window, Related Parts	211

Pre-War

Clutch Linkage	221
Manifold Gaskets	164
Rear Axle	285-286
Steering Parts	272
(Also contained in other sections of the catalog)	

Prop

Hood & Related Parts	87
----------------------------	----

Protectors

Dash	34
Front Fender	305
Fuel Filler	172
Gas Pedal	178

Puller

Brake Drums	251
Pitman Arms	260
Steering Wheel	258

Pulley

Catalog Section	57
-----------------------	----

Pump

Convertible Top	86
Foot (Windshield Washer)	56
Fuel	173
Oil	237-238
Power Steering	257
Water & Related Parts	184

Q

Quarter

Glass, Rear	53
Rear Roof Reinforcement Panels	143
Rear Window Frame Assemblies	140

Quick

Steering Arms	258
---------------------	-----

R

Radiator

Catalog Section 182-183

Radio

Catalog Section 30-32

Rail

Drip Joiner Piece 87
 Frame Rail Plates 216

Reach

Rod (or Drag Link) 260, 275, 279-283

Rear

Axle & Related Parts 263, 284-287
 Bearings (Transmission) 223
 Door Frame Assemblies 144-145
 Glass (Various) 51-53
 Leaf Springs 267-268
 Panels 140-144
 Shelf Cover 29
 Spring Bushings for Cars & Trucks 269
 Stabilizer Bar & Related Parts 262
 Traction Bar & Related Parts 262

Rearview

Mirrors, Exterior 18
 Mirrors, Interior 29

Rebuild Kits

Brake 252-254
 Brake Boosters 249
 Carburetor 175-176
 Engine 166-167
 Power Steering 258
 Starter Motor 205
 Transmission 219
 Water Pump 184

Reclining

Seat Parts 26

Regulator

Voltage 207
 Window 47-48

Reinforcement

Battery Tray (Avanti) 213
 Panels for Rear Quarter Roof 143

Relay

Horn 214
 Overdrive 226

Remote

Door 132

Removal

Tool (Door & Window Handle) 43
 Tool (Steering Wheel) 258

Resistor

Ignition Coil 200

Retainer/Retainers

Ashtray 41
 Back-up Light 195
 Bearing Kit 220
 Brake Shoes 255
 Clutch Linkage 222
 Emblem 23-24
 Floor Shifter 217-218
 Fly Wheel Clutch 232
 Gauges 28
 Seat Back, 1963-66 Station Wagon 135
 Stabilizer Bars (Front or Rear) 262
 Tail Light 195

Rim

Headlight 192-193
 Tail & Back-up Lights 194-195

Ring

Emblem Retainer 24
 Gauge 28
 Gear Starter 220
 Key 307

Rocker

Cover & Related Parts 162
 Decals 8
 Panel 144

Rod

Connecting 157
 Hood Prop 87
 Reach (or drag link) 260, 275, 279-283
 Sunvisor Anti-Rattle 29

Roof

Area Panels (Sheet Metal) 143
 Reinforcement Panels 142
 Seals 59

Roll/Roller

Bar Cover & Clips (Avanti) 38
 Window 47

Roof

Area Panels (Sheet Metal) 143

Convertible 86-87
 Drip Rail (Joiner) 87
 Ornaments, Emblems, Mouldings 22-25
 Sliding, Station Wagon Catch & Latch 135
 Sliding, Station Wagon Weather Seals 61
 Sliding, Warning Decal 10
 Vinyl Covers 87

Rotor

Distributor 203
 Disk Brake 253

Rubber

Adhesive 60
 Catalog Section 59-84

Running Lights

Front Fender Spear (GT Hawk) 197
 Safety (Hides behind Grille) 195

S

Saddle

Assembly 164
 Rear Frame (Avanti) 216

Safety

Catch Hood 88
 Child, Door Lock Set 132
 Running Lights 195

Screen

Air Vent, Front Fender 185
 Filter, Automatic Transmission 219

Screw Kits or Sets

Kits, Body 39
 Kits, Lens 198

Script

Catalog Section 21-22

Seal

Brake & Clutch Pedal 247
 Door & Window Handle 43
 Fender Corner 141
 Heater 186
 Heater/Defroster 187
 Transmission 218

Sealer

Dum-dum, Body 92
 Silicone Gasket 156

Seam Filler/Welt

Rear Fender to Body (Also see "Fender Welt")..... 141

Seat

Belts 26
 Covers (Avanti)..... 35
 Related Decals 10
 Related Parts..... 26, 35
 Retainer, Rear Station Wagon..... 135
 Valve..... 163

Self-Adjuster

Brake Parts..... 250

Sender/Sending Units

Fuel 173
 Tachometer..... 27
 Water Temperature..... 185

Shaft

& Levers, Clutch Release 220
 Axle 284-287
 Drive 266
 Sector..... 272-274
 Transmission 226-245

Sheet Metal

Catalog Section
 (Also see "Panels")..... 138-146

Shelf

Rear Package..... 29

Shield/Shielding

Body from Gravel 20, 141
 Fuel Pump from Heat 173
 Ignition (Avanti)..... 200
 Pedal Protector (Truck)..... 146

Shift/Shifter

Parts..... 217-218
 & Levers, Clutch Release 218, 220

Shirts

and Sweatshirts..... 311-315

Shoe

Brake Sets, Relined & New 255
 Related Parts..... 250-255

Shop

Manuals (Printed) 11
 Manuals (Supplements)..... 12

Shroud

Decals 9
 Fan 185

Side

Panels, Hood (Sheet Metal) 143

Signs

Metal, Cardboard & Porcelain 306

Sill

Plates, Mouldings, Attaching Screws 37
 Panels (Rocker)..... 144

Skin

Door (Sheet Metal)..... 142

Sliding

Rear Window (Champ Truck) 51

Slinger

Oil (Crankshaft) 160
 Transmission 227, 279

Small

Parts Kits (Body) 128-130

Socks

Studebaker 313

Solenoid

Anti-Creep..... 209
 Overdrive..... 226, 229, 232-234
 Starter 204

Spacer

Coil Spring..... 268
 Counter Shaft 231
 Door & Window Handles 43
 Horn 214
 Shock Absorbers..... 265
 Thermostat 1939-60 6-cyl..... 185

Spark

Plugs 202
 Plug Covers (Avanti)..... 202

Speaker

and Related Parts..... 30

Speedometers

and Related Parts..... 27

Splash

Apron (Inner Fender)..... 142
 Guard Rear..... 139, 141
 Guard 20

Spring/Springs

Above Door Flippers, K & 58-J Bodies... 131
 Brake 251
 Bushing (Leaf)..... 269
 Clutch Return 222

Distributor 203
 Door 131
 Gas Lid..... 172
 Generator Brush..... 206
 Hood..... 88
 Front Coil & Related Parts..... 268
 Heat Riser & Thermostatic for Exhaust
 Manifold..... 163
 Hood Hinge 88
 Ignition Switch 201
 (Leaf)..... 267-268
 Oil Pressure Relief Valves 160
 Rear Quarter Window..... 53
 Seat & Reclining 26
 Starter Motor Brush..... 206
 Supercharger..... 179-180
 Tailgate Hinge..... 134
 Throttle Return 179
 Trunk Hinge 134
 Valve..... 163
 Vent Window 50
 Windshield Wiper Motor Brushes 211

Starter

Motors & Related Parts 204-205
 Ring Gear 220

Steering

Arm (Quick & Idler)..... 258
 Box & Column (Seals) 258
 Box or Gear 259, 272-275
 Catalog Sections 257-261, 272-275
 Column 258-259
 Front, & Related Parts 278-283
 Post Collar Fastener (Avanti)..... 259
 (Power)..... 257-258
 Pump 257
 Stabilizer Bar, Front or Rear & Related Parts
 262
 Wheels & Related Parts 258

Stem

Mirror 18
 Valve Parts 163

Stereo

Radio & Related Parts 30-32

Stickers

Bumper..... 307
 Engine, Oil, Tire, etc. 8-10
 Logo & Tattoo..... 295
 Window..... 294-295

Strainer

Automatic Transmission	219
Oil Pump.....	160

Strap

Exhaust Hanger.....	165
---------------------	-----

Stud

Mounting, Power Steering Pump.....	258
Water Pump Manifold.....	184
Wheel	264

Studebaker

Clubs	7
Decals	10
Letters (Chrome) for Hoods, Trunks, & Fenders	22-25
Literature	11-17
Location.....	6
Script.....	21-22
Socks.....	313
Wheel Related.....	20-21

Sun

Glasses	314
Visors	29

Supercharger

Belts	58
Decals	10
Related Parts.....	178

Suspenders

Studebaker	312
------------------	-----

Suspension

Catalog Section.....	260-269
----------------------	---------

Switch

Control (Catalog Section) Emergency, Electric door, Fog, Headlight, Instrument, Anti-Creep, Heat, Oil, etc.	208-209
Electric Fuel Pump (Safety).....	173
Electric Wiper	210
Horn	214
Ignition.....	201
Label Sets (Toggle).....	209
Overdrive Lockout & Kick Down.....	226
Overhead Nameplate	42
Speaker	32
Starter	204
Window or Back Glass 1963-66 Station Wagon.....	137
Windshield Washer	56

T

Tachometer

Related Parts.....	27-28
--------------------	-------

Tag

Delco & Prestolite, Metal for Distributors, Generators, & Alternators.....	207
---	-----

Tailgates (Pickup)

& Related Parts	145-146
-----------------------	---------

Tailgates (Station Wagon)

Catalog Section.....	135-137
Glass	54
Lock Cylinders.....	133-134
Motor (Back Glass Lift).....	211
Switch.....	211

Tail Light

Lens.....	198-198
Mounting Brackets (Trucks).....	195
Rims, Housings & Bezels.....	194
Seals & Gaskets.....	198

Tattoo

Temporary	295
-----------------	-----

Temperature

Gauges.....	28
Sending Units	185

Thermostat

Housings & Gaskets.....	185
Spacer, 1939-60 Champion 6-cylinder...	185

Throttle

Checks, Boots, Return Springs & Related Parts.....	179
---	-----

Ticket

Factory Production	298
--------------------------	-----

Tie

Neck (High Quality Silk)	315
Rod Ends & Assemblies	261, 276-277, 279-284
Tack & Pins.....	310

Timing

Cover & Related Parts.....	156
Gears (Camshaft & Crankshaft).....	157

Tool

Brake Drum Puller	251
Door & Window Crank Handle Clip Removal	43
Steering Wheel Puller.....	258
Wrench, Spare Tire (Trucks).....	20

Torque

Converters.....	217
-----------------	-----

Tower/Cover

Floor Shifter.....	218
--------------------	-----

Toy

Flying Saucer (Frisbee)	308
-------------------------------	-----

Trailer

Hitch-Ball & Receiver Covers.....	305
-----------------------------------	-----

Transmission

1939-46 Standard & Overdrive	227-239
1947-57 T-86/T-96 Standard & Overdrive	230-231
1950-55 "DG" Automatic.....	236-239, 241
1956-66 "Flight-O-Matic"	242-245
1958-66 T-86/T-96 Standard & Overdrive	234-235
Catalog Section.....	216-245
Clutch Related Parts	219-223
Flex Plate (Converter).....	219
Filter Screen	219
Floor Shifter Parts, Automatic & 4-Speed	17-218
Gaskets, Seals & Related Kits.....	219
Overdrive.....	226-235
Shifter.....	217-219

Tray

Ash & Related Parts.....	41
Battery Reinforcement (Avanti)	213

Trunk

& Glove Box Keys.....	40, 134
Emblems & Scripts	21-25
Handle Decals (1950).....	25
Lid Weather Seals	60
Liners & Mats	37
Lock Assemblies, Hinges, Springs, & Seals.	133-134
Panels (Sheet Metal).....	143-144
Switches (Light).....	208

Turn Signal

Canceler	208
Flasher	208
Knobs & Levers	39
Lens.....	196
Switches & Related Parts.....	208

U

U-Bolt

Front & Rear Leaf Springs.....	268
Header Pipe to Exhaust Pipe, V-8s.....	164

Umbrella

Standard.....	309
---------------	-----

Unit

Overdrive.....226-235

Universal

Joints.....265

Upholstery

Seat Covers.....35

V

Valve

Block, DG Automatic Transmission.239-240

Control Flight-O-Matic.....242-245

Grind Gasket Sets.....163

Guides, Springs, Seats, Lifters, etc.....163

Heater Control.....186

Intake & Exhaust.....162

PCV.....179

Stem Caps, Tire Air Filler.....305

Stem Seals & Stud Cover Grommets (O.H. V-8s & 6 Cylinder).....163

Vent

Air (Vent) Housing Pieces, Front Fender, Air Intake.....184

Air (Vent) Seals & Kits.....60

Window Assemblies.....50

Window Channels & Related Seals.....61

Window Related Hardware.....49-50

Vibration

Damper, Jet-Thrust Engine Front.....156

Vinyl

Dye (Avanti).....34

Roof Covers.....87

Viscous

Fan Drive or Clutch.....185

Voltage

Regulator.....207

W

Warranty

Details on Parts Purchased.....6

Water

Outlet (Thermal Housing).....185

Pumps & Related Parts.....184

Temperature Gauges.....28

Temperature Sender.....185

Weatherseal

Adhesive.....60

Air Vent.....60

Cowl.....60

Installation Instructions.....59

Kits.....63-85

1941-48 M-Series Truck.....63

1949-64 C-Cab Truck.....63

1947-Early 1948 Convertible.....64

1948-52 Convertible.....64

1947-52 4-Door Sedan & Land Cruiser.....65

1947-52 2-Door Sedan.....66

1947-52 2-Door Starlight Coupe.....66

1947-51 2-Door Business Coupe.....67

1952 2-Door Hardtop.....67

1953-55 2-Door Sedan.....68

1953-55 4-Door Sedan.....68

1954-55 2-Door Station Wagon.....69

1953-61 C-Body Coupe.....69

1953-58 K-Body Hardtop.....70

1958 2-Door Hardtop.....70

1955-58 2-Door Station Wagon.....71

1957-58 4-Door Station Wagon.....71

1955-58 2-Door Sedan.....72

1955-58 4-door Sedan.....72

1959-60 Lark 2-Door Sedan.....73

1959-60 Lark 4-Door Sedan.....73

1959-60 Lark 2-Door Hardtop.....74

1960-62 Lark Convertible.....74

1959-60 2-Door Station Wagon.....75

1960-62 Lark 4-Door Station Wagon.....75

1961 Lark 2-Door Hardtop.....76

1961 Lark 2-Door Sedan.....76

1961 Lark 4-Door Sedan.....77

1961 Cruiser.....77

1962 Lark 2-Door Sedan.....78

1962 Lark 4-Door Sedan & Cruiser.....78

1962 Lark 2-Door Hardtop.....79

1962-64 Gran Turismo Hawk.....79

1963 Lark 2-Door Hardtop.....80

1963-66 4-Door Station Wagon.....80

1963 4-Door Sedan.....81

1963 2-Door Sedan.....81

1963-64 Convertible.....82

1964 2-Door Hardtop.....82

1964-66 2-Door Sedan.....83

1964-66 Lark 4-Door Sedan.....83

1966-64 Champ Truck.....84

1963-83 Avanti.....84

Pre War.....59-60

Sliding Roof (Station Wagon).....61

Trunk.....60

Windshield & Back Glass.....59

Windshield Center Bar.....60

Window Channels.....61-62

Well Nut

Exterior Mirror (Avanti).....18

License Bracket to Body (Avanti).....91

Wheel

Bearings, Front & Related Parts.....264

Covers, Hubcaps & Cover Restoration Kits.....19-20

Cylinders & Kits.....253-254

Fly.....153

House Panel (Sheet Metal).....142

Mounting Studs & Nuts.....264

Paint.....20

Steering (Call).....258

Truck (Dayton & ½ ton).....254

Well Moulding Clips.....20

Windlace.....38

Window

Cranks, Escutcheons, Clips, Spacers, Knobs, & Screws.....43

Motor & Related Power Window Parts...211

Rear Quarter Frame Assemblies.....53

Rear, Sliding (Champ Truck).....51

Regulators.....47-47

Rollers, Clips & Related Kits.....47

Stickers.....294-295

"U" Channels & Other Related

Weatherseals.....60-62

Vent (Window) Hardware, Frames, & Assemblies.....50-51

Windshield

To Buy.....55

Center Bar Kits.....60

Decals.....10

Seals (Weatherseals).....59

Post Moulding (Avanti).....55

Washer Parts & Kits.....56

Wiper Arms & Blades.....54

Wiper Switches, Motors & Related Parts.....210-211

Wire/Wiring

Harnesses.....212-213

Spark Plugs, Ignition.....202

Wrench

Spare Tire (Truck).....20



111 Aiken Street Hope, IN 47246

Phone: 317-462-3124

Fax: 317-462-8891

Website: www.studebaker-intl.com

E-Mail: leann@studebaker-intl.com

Hours: 8am - 6pm Mon - Fri

We accept:



Customer Number:		
Name:		
Street Address:		<input type="checkbox"/> New Address?
City:	State:	Zip:
Phone:		
Date:		

Year	Model	Engine	Trans
			Automatic <input type="checkbox"/>
			Standard <input type="checkbox"/>

Form of Payment			
<input type="checkbox"/> Cashiers Check/Money Order/Certified Check	Name:	Sub Total:	
<input type="checkbox"/> Personal Check <i>(allow 10 days for clearance)</i>	Address:	Sub Total from Back:	
<input type="checkbox"/> Credit Card	Number:	10% Shipping & Handling Estimate: <i>(\$10.00 minimum)</i>	
	Ex. Date:	In Res. Add Tax:	
	Security Code:	Total:	

Quantity	Part Number	Item Description	Price



Corey Lime
Hope, VP



Leanne Butler
Hope, Office Manager



Susan Buck
SV, Order Desk (Special Orders)



Joe Fougousse
Warehouse Manager



David Blanton
Warehouse Asisstant



Matt
Warehouse Asisstant

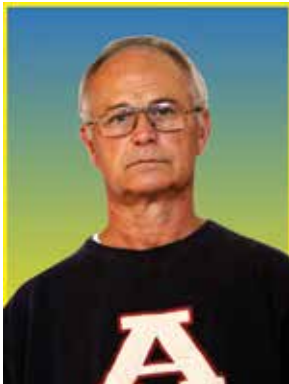

Bob Johnson
Warehouse Facilitator



Brady Wolsiffer
E-Commerce Sales & Marketing

GENERAL INFORMATION

leanne@studebaker-intl.com
or (317) 462-3124
FAX: (317) 462-8891

CORRESPONDENCE

All returns should be sent to:

111 Aiken Street
Hope, IN 47246

News about your Studebaker projects is always welcome and should be e-mailed to brady@studebaker-intl.com

SHELBYVILLE

Hours vary, please call before visiting our Shelbyville location at:

630 South Noble Street
Shelbyville, IN 46176

Please do not send correspondence or returns to this address

©This catalog is published by Studebaker International
Copyright 2024
Printed: USA

All rights reserved. No part of this publication may be reproduced, stored, or transmitted in any form or by any means without the written permission of this publication.

Any use or reuse of this publication for any commercial purpose without the express consent of the publisher is prohibited.

Any sale or distribution of this publication without the express consent of the publisher is prohibited

Studebaker International
Jim Lime, President
Corey Lime, Vice President



111 AIKEN ST., HOPE, IN 47246
(317) 462-3124



Photo Credit: Justin Laird's 1961 Lark Skytop from Napa, California.